

# SHAD

www.shades

COMFORT SEATS

MOTOR CASES

SOFT BAGS

ATV CASES



# NAD S.L.

# 40

## Anniversary

**40 años haciendo  
LAS COSAS BIEN HECHAS.**

*Since 1973*

Este año, en el que celebramos el 40 aniversario de la empresa, nos mantenemos como líderes europeos en la fabricación de sillines y Top cases para las primeras marcas de motos.

Desde 1973, comenzamos a crear un equipo humano imparabile, a quienes nos gustan los retos y las cosas bien hechas. El trabajo constante nos ha permitido tener los mejores clientes, proveedores cualificados y productos de alta calidad que distribuimos alrededor del mundo.



## 40 years doing THINGS WELL.

This year, in which we celebrate the company's 40th anniversary, we keep our lead as seat and top cases manufacturer for the most important motorcycle brands.

Since 1973, we have been creating an amazing staff. We love challenges and things well done. The consistent work allowed us to have the best customers, qualified suppliers and high-quality products that we distribute all over the world.

## 40 ans en faisant LES CHOSES BIEN FAITES.

Cette année, nous célébrons le 40<sup>e</sup> anniversaire de la société. Nous restons leaders en fabrication de selles et top cases pour les grandes marques de motos.

Depuis 1973, nous avons créé une équipe, qui aime les défis et les choses bien faites. Ce travail constant nous a permis d'avoir les meilleurs clients, fournisseurs qualifiés et des produits de haute qualité distribués dans le monde entier.

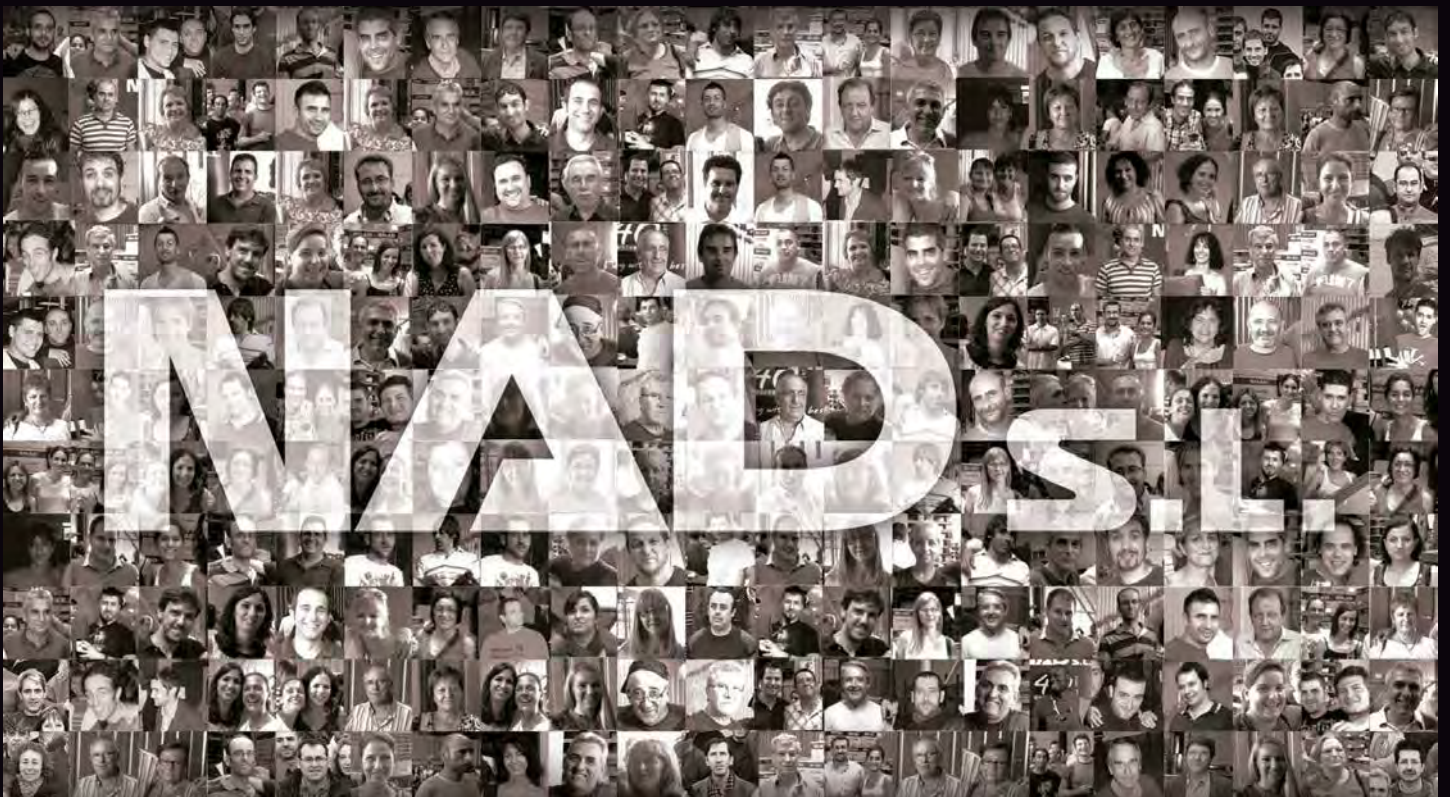

# NAD S.L.

•ESP El grupo NAD s.l -propietario de la marca SHAD- diseña, produce y distribuye top cases y sillines para las principales marcas de motos.

Nuestra evolución constante nos ha permitido tener contacto con los principales fabricantes del sector, que día a día nos impulsan a asumir retos técnicos necesarios para liderar el segmento de Top Cases y Sillines

En NAD s.l creemos que trabajar con los mejores del sector es nuestra principal motivación para mantenernos como líderes.

•ENG NAD, S.L. Group -owner of the SHAD brand- designs, produces and distributes top cases and seats for the most important motorcycle brands.

Our constant evolution allowed us to keep the contact with the most important companies in the field, and day after day they inspire us to take new technical challenges in order to lead the top cases and seats manufacturing sector

At NAD S.L. we believe that working with the best in our sector is our main motivation to keep our lead.

•FR Le groupe NAD s.l. - propriétaire de la marque SHAD- dessine, fabrique et distribue top cases et selles pour les principales marques de motos.

Notre évolution constante nous a permis d'être en contact avec les principaux fabricants de motos, qui nous aident tous les jours à assumer les défis techniques nécessaires pour être à la tête du marché du top cases et des selles.

Chez NAD sl, nous croyons que travailler avec les meilleures marques dans l'industrie est notre principale motivation pour nous maintenir en tant que leaders.



# NAD S.L.

Nuestro éxito  
lo queremos  
agradecer  
a nuestros  
clientes:

We want to thank  
our customers  
for making  
our success  
possible:

Nous remercions  
nos clients pour  
notre succès:

aprilia



BRAMMO



CFMOTO



GASGAS

going  
GREEN



KTM  
RACING

MBK  
A NEW WORLD

MOTORHISPANIA  
MCH  
MOTORCYCLES

PIAGGIO®

Roca

SUZUKI

TRIUMPH

volta  
MOTORCYCLES



DERBI

GILERA



HONDA

KEEWAY

KYMCO



MOTO GUZZI



PEUGEOT  
Motorcycles

RIEJU

SYM

tecnigas  
MOTORCYCLES & EQUIPMENT

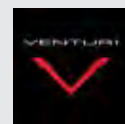

VENTURA

YAMAHA

# SHAD



•ESP Después de 20 años de la fundación de NAD s.l, en 1992, creamos la marca SHAD, para diseñar, producir y distribuir nuestros productos en mercados internacionales.

Con más de 20 años en el mercado, nuestro catálogo lo conforman Top y Side cases, sistemas de fijación, sillines confort, soft bags (línea textil) y productos para ATV. Gracias a la calidad, innovación y funcionalidad de nuestros productos, tenemos presencia en más de 70 países.

•ENG 20 years after NAD S.L was founded, in 1992, we created SHAD brand in order to design, produce and distribute our products to the international markets.

After more than 20 years in the market, our catalogue includes top and side cases, mounting systems, comfort seats, soft bags and products for ATVs. Thanks to the quality, innovation and functionality of our products, we are present in more than 70 countries.

•FR Après 20 ans d'existence de NAD sl, en 1992, nous avons créé la marque SHAD, pour concevoir, produire et distribuer nos produits sur les marchés internationaux.

Avec plus de 20 ans d'expérience sur le marché, notre catalogue est constitué de top cases et valises, systèmes de fixation, des selles confort, bagagerie souple (ligne textile) et les produits pour ATV. Grâce à la qualité, l'innovation et la fonctionnalité de nos produits, nous avons une présence dans plus de 70 pays



# Around the world

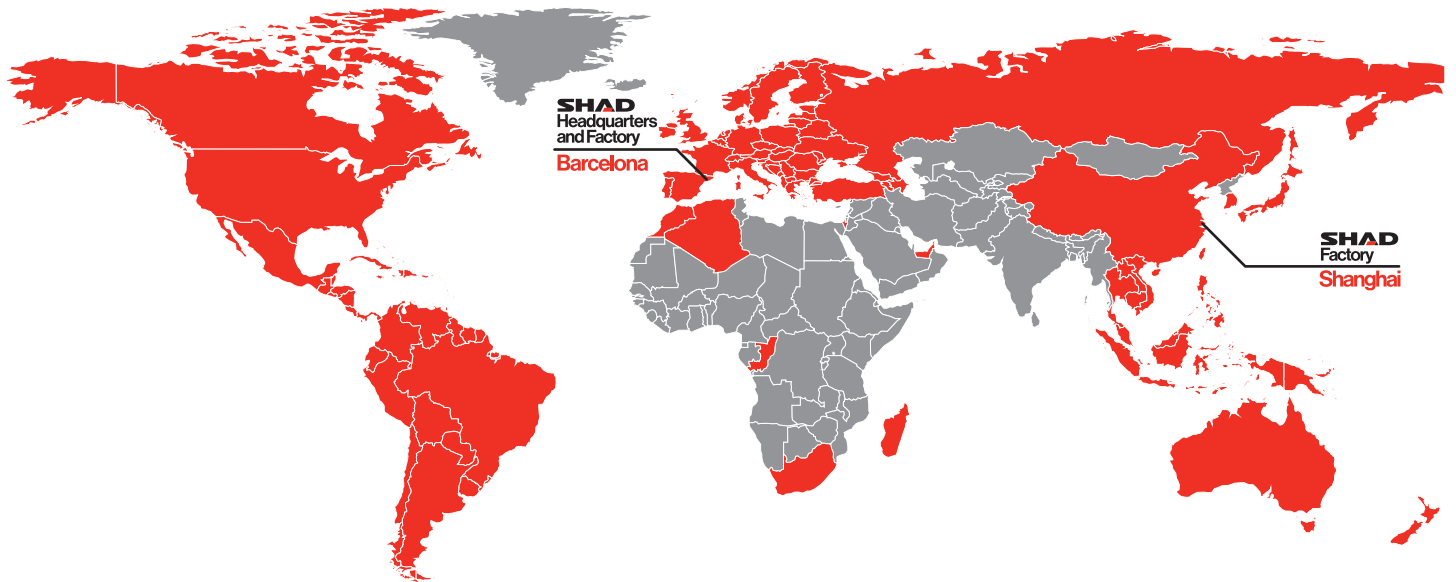

• U.S.A. & North America • South. & Central America • Spain • France • Europe • Asia & Australia •

Around the world • Around the world • Around the world  
Present in  
**70** more than  
Countries  
Around the world • Around the world • Around the world



DISEÑO Y TECNOLOGIA  
Innovación y confianza

DESIGN AND TECHNOLOGY  
Innovation and trust

DESSIN AND TECHNOLOGIE  
Innovation et Confiance

• **ESP.** En NAD s.l tenemos un sólido departamento de I+D, en el que establecemos relaciones directas con nuestros clientes, basadas en el servicio y la confianza.

Materializamos las ideas de nuestros clientes con innovación y con una metodología de mejora constante en el desarrollo y fabricación de cada proyecto, que respaldamos con 40 años de experiencia.

Nuestro departamento de I+D utiliza tecnología punta para prestar un servicio integral y eficiente desde nuestra posición de líderes europeos del sector.

• **ENG.** At NAD s.l we have a solid R&D department where we keep direct contact with our customers based on service and trust.

We make the ideas of our customers true through innovation and constantly improving the development and manufacturing of each project, backed by our 40-year experience.

Our R&D department uses state-of-the-art technology to offer a comprehensive and efficient service that reinforces our position as European leader in our sector.

• **FR.** Chez NAD SL nous avons un important département RD, où nous établissons des relations directes avec nos clients, basées sur le service et la confiance.

Nous faisons réalité les idées de nos clients grâce à l'innovation et à la méthodologie d'amélioration continue dans le développement et la fabrication de chaque projet, que nous soutenons avec 40 ans d'expérience.

Notre département RD utilise la dernière technologie pour fournir un service complet et efficace dès notre position de leaders dans l'industrie européenne.

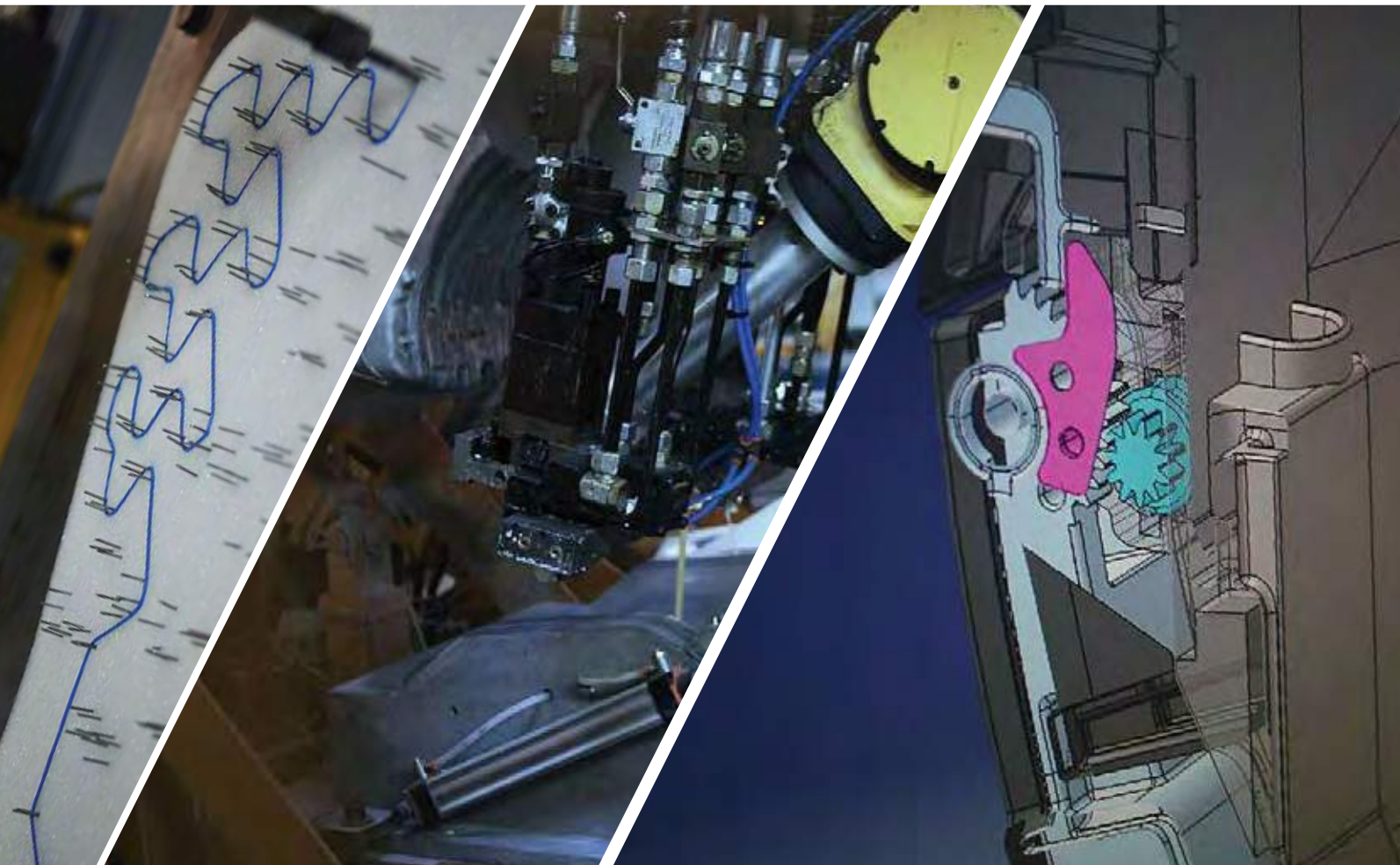





ACREDITADO POR ENAC

# Quality

CALIDAD  
Certificada y Estandarizada

**ES** En el departamento de calidad trabajamos conjuntamente con el equipo de I+D en las diferentes fases del desarrollo de un proyecto, para asegurar el cumplimiento de todas las especificaciones aportadas por el cliente y verificar los estándares de calidad del producto antes y durante de la producción en serie.

Esto sumado a una relación cercana con nuestros clientes, diferentes ensayos en laboratorio y en ruta y una disposición a mejorar continuamente, nos permiten ofrecer productos con altos estándares de calidad certificada.

QUALITY  
Certified and standardized

**ENG** At the Quality department we work together with the R&D team through the different phases of a project's development in order to guarantee that all specifications made by the customer are met and to verify the product's quality standards before and during production.

All this, together with a close relationship with our customers, several tests both in lab and on the road, and the will to improve constantly, allow us to offer products with high standards of certified quality.

QUALITÉ  
Certifiée et standardisée

**FR** Dans le département de qualité, nous travaillons ensemble avec l'équipe RD dans les différentes phases du développement d'un projet pour assurer la conformité avec toutes les spécifications fournies par le client et pour vérifier les standards de qualité du produit avant et pendant la production en série.

Ceci, ensemble avec une relation proche de nos clients, différents tests en laboratoire et en route et une volonté d'amélioration continue, nous permettent d'offrir des produits avec les certificats de qualité le plus prestigieux.

## TOP CASES

**SH50**



Pág. 16 - 17

**SH49**



Pág. 18 - 19

**SH48**



Pág. 20 - 21

**SH46**



Pág. 22 - 23

**SH45**



Pág. 24 - 25

**SH42**  
TOPCASE



Pág. 26 - 27

**SH40**



Pág. 28 - 29

**SH40**  
CARGO



Pág. 30 - 31

**SH39**  
NEW



Pág. 32 - 33

**SH37**



Pág. 34 - 35

**SH33**  
RED  
WHITE



Pág. 36 - 37

**SH29**



Pág. 38 - 39

**SH26**



Pág. 40 - 41

## SIDE CASES

**SH43**  
RED  
WHITE



Pág. 44 - 45

**SH42**  
TOP &  
SIDE CASE



Pág. 46 - 47

**SH36**  
NEW



Pág. 48 - 49

## FITTING KITS

**Backrest**



Pág. 52

**Sissybars**



Pág. 53

**SPORT  
RACK**



Pág. 54

**Attachment  
SUPPORTS**



Pág. 55

**FITTING KITS**

Pág. 56 - 57

## COMFORT SEATS

**Yamaha  
X MAX**



Pág. 60

**Yamaha  
T MAX**



Pág. 60

**Yamaha  
FAZER FZ6**



Pág. 61

**Yamaha  
FAZER FZ 8**



Pág. 61

**Yamaha  
X J6**



Pág. 62

**Yamaha  
MT-09**



Pág. 62

**Kawasaki  
Z750/1000**



Pág. 63

**Kawasaki  
Z800**



Pág. 63

**Kawasaki  
ER6**



Pág. 64

**Kawasaki  
ER6**



Pág. 64

**Suzuki  
BANDIT**



Pág. 65

**Suzuki  
GLADIUS**



Pág. 65

**Suzuki  
GSR750**



Pág. 66

**Honda  
HORNET**



Pág. 66

**Honda  
CBF**



Pág. 67

**Honda  
CBR600**



Pág. 67

**Honda  
NC700X  
NC750X**



Pág. 68

**Honda  
NC700S  
NC750S**



Pág. 68

**Honda  
INTEGRA**



Pág. 69

**Piaggio  
MP3**



Pág. 69

## SPARE PARTS

Pág. 104 - 109

## DISPLAYS

Pág. 110 - 111

## ICONS

Pág. 12 - 13

# 100% WATERPROOF BAGS

**SW05**  
WATERPROOF  
SMALL BAG



Pág. 72

**SW40**  
WATERPROOF  
REAR TUBE



Pág. 72

**SW25**  
WATERPROOF  
REAR BACKPACK



Pág. 73

**SW35**  
WATERPROOF  
REAR BACKPACK



Pág. 73

**SW22**  
WATERPROOF MAGNET  
TANKBAG + BACKPACK



Pág. 74

**SW18**  
WATERPROOF  
LAPTOP BAG



Pág. 74

**SW38**  
WATERPROOF REAR  
DUFFLE BAG



Pág. 75

**SW28**  
WATERPROOF  
REAR BAG



Pág. 75

**SW42**  
WATERPROOF  
SADDLE BAGS



Pág. 76

**SW55**  
WATERPROOF  
TRAVEL BAG



Pág. 76

**SW90**  
WATERPROOF BIG  
TRAVEL BAG



Pág. 77

**SW138**  
WATERPROOF HUGE  
TRAVEL BAG



Pág. 77

# SOFT BAGS

**SB110**  
NEW  
GEAR BAG SPECIAL  
FOR PILOTS



Pág. 80

**SB70**  
REAR BAG



Pág. 80

**SB50**  
SADDLE BAG



Pág. 81

**SB44**  
SPORT SIDE BAG



Pág. 81

**SB60**  
SADDLE BAG



Pág. 82

**SB35**  
BIG TANK BAG



Pág. 83

**SB25**  
TANK BAG



Pág. 83

**SB23**  
ENDURO BAG



Pág. 84

**SB22**  
TANK BAG



Pág. 84

**SB15**  
GPS TANK BAG



Pág. 85

**SB90**  
BACK PACK



Pág. 85

**SB85**  
BACK PACK



Pág. 86

**SB80**  
BACK PACK



Pág. 86

**SB12**  
TANK POUCH MAGNET  
TANK POUCH SUCTION



Pág. 87

**SB11**  
TANK POUCH



Pág. 87

**SB05**  
HOLSTER BAG



Pág. 88

**SB04**  
HOLSTER BAG



Pág. 88

**SB03**  
RIDER POUCH



Pág. 89

**SB T5**  
WAIST BAG



Pág. 89

**SB T4**  
TOLL PASS POUCH



Pág. 90

**SB T2**  
TOOL BAG



Pág. 90

**SB T1**  
TOOL BAG



Pág. 90

**SC30**  
SCOOTER BAG



Pág. 91

**SC20**  
SCOOTER BAG



Pág. 91

**SG 50M-40M**  
NEW GPS HOLDER  
MIRROR BRACKET



Pág. 92

**SG 50H-40H**  
NEW GPS HOLDER  
HANDLEBAR BRACKET



Pág. 92

**SG 60M-20M-10M**  
NEW SMARTPHONE HOLDER  
MIRROR BRACKET



Pág. 93

**SG 60H-20H-10H**  
NEW SMARTPHONE HOLDER  
HANDLEBAR BRACKET



Pág. 93

# ATV CASES

**ATV110**



Pág. 96 - 97

**ATV80**



Pág. 98 - 99

**ATV40**



Pág. 100 - 101

**ATV BAG100**



























Pág. 102

**ATV BAG55**



Pág. 103

# ICONS DESCRIPTION

 <p>Capacity 1 integral helmet Capacidad 1 casco integral Capacité 1 casque intégral Volumen für 1 integralhelm Capacità 1 casco integrale Capacidade 1 capacete integral</p>	 <p>Capacity 2 integral helmets Capacidad 2 cascos integrales Capacité 2 casques intégral Volumen für 2 integralhelm Capacità 2 caschi integral Capacidade 2 capacete integrais</p>	 <p>Capacity 1 jet helmet Capacidad 1 casco jet Capacité 1 casque jet Volumen für 1 helm jet Capacità 1 casco jet Capacidade 1 capacete jet</p>
 <p>Capacity 2 helmets: integral and jet Capacidad 2 cascos: integral y jet Capacité 2 casques: intégral et jet Volumen für 2 helme: integralhelm und jet Capacità 2 caschi: integrale e jet Capacidade 2 capacetes: integral e jet</p>	 <p>Capacity 2 jet helmets Capacidad 2 cascos jet Capacité 2 casques jet Volumen für 2 helme jet Capacità 2 caschi jet Capacidade 2 capacetes jet</p>	 <p>Capacity gloves and integral helmet Capacidad guantes y casco integral Capacité gants et 1 casque intégral Volumen für handschuhe und 1 integralhelm Capacità quanti ed 1 casco integral Capacidades luvas e capacete integral</p>
 <p>Capacity gloves and 2 jet helmets Capacidad guantes y 2 cascos jet Capacité gants et 2 casques jet Volumen für handschuhe und 2 helme jet Capacità quanti e 2 caschi jet Capacidade luvas e 2 capacetes jet</p>	 <p>Backrest Respaldo Dossieret Rückenpolster Shienale Encosto</p>	 <p>SHAD change colour system</p>
 <p>Smart lock system</p>	 <p>Press lock system</p>	 <p>Light Luz Feux Licht Luce Luz</p>
 <p>GPS holder Sujeta GPS Porte GPS GPS ablagemöglichkeit Porta GPS Porta GPS</p>	 <p>Shoulder strap Bandolera Bandoulière Tragegurt Tracolla Bandoleira</p>	 <p>Expandable Extensible Extensible Ausdehnbar Espandibile Estensível</p>
 <p>Magnetic Magnética Magnétique Magnet Magnético</p>	 <p>Suction cups Ventosas Ventouses Saugknöpfe Ventose Ventosa</p>	 <p>Attachment straps Correas de fijación Portecarte Sangles de fixation Sicherheitsgurt Cinghie di attacco Correias de fixação</p>
 <p>Convertible in backpack Transformable en mochila Transformable en sac à dos In einen rucksack umwandelbar Transformabile in zainetto Transformável en mochila</p>	 <p>Extra elastic straps Correas elásticas extra Extra sangles élastiques Elastikgurt Cinghie elastiche extra Correias elásticas extra</p>	 <p>Map holder Sujeta mapa Portecarte Kartenfach Portacartina Porta mapa</p>
 <p>Inner tray</p>	 <p>Heat protector Kit térmico Kit thermique Kit térmico Thermischer kit Kit térmico</p>	 <p>Rain cover Bolsa impermeable Housse imperméable Regenhaube Borsa impermeabile Bolsa impermeável</p>



Water resistant zip  
Cremallera impermeable  
Fermeture imperméable  
Wasserdichter reissverschluss  
Chiusura impermeabile  
Zipper impermeável



Capacity  
Capacidad  
Capacité  
Volumen  
Capacità  
Capacidade

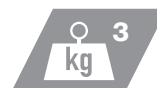

Maximum load  
Carga máxima  
Charge maximum  
Maximale last  
Carica massima  
Carga máxima



Headphones slot  
Ranura auriculares  
Ouverture casque  
Kopfhörer schlitze  
Scanalatura auricolare  
Abertura fones de ouvido



Reflector  
Reflector  
Réflecteur  
Reflektor  
Riflettore  
Refletor



Universal fitting  
Adaptación universal  
Adaptation universale  
Universal - anpassung  
Adattamento universale  
Adaptação universal



Inner pockets  
Bolsillos interiores  
Poches intérieurs  
Innentaschen  
Tasche interne  
Bolsos interiores



Waterproof  
Impermeable  
Imperméable  
Wasserdicht  
Impermeabile  
Impermeável



Cristal film for touch screens  
Film transparente para  
pantallas táctiles  
Film transparent pour  
écran tactile



Adjustable internal shims  
Cuiñas interiores ajustables  
Hausse interne adaptable



Tablet  
Tablet holder  
Espacio Tablet  
Porte tablet



Touch screen  
Pantalla táctil  
Écran tactile



Handlebar bracket  
Soporte para manillar  
Support guidon



Mirror Bracket  
Soporte para retrovisor  
Support rétroviseur



Waterproof case and zip  
Estuche y cremallera impermeables  
Support et fermeture imperméables



Maximum protection  
Máxima protección  
Protection maxime



Hole for battery charger  
Orificio para cargador de batería  
Ouverture pour chargeur batterie



Inner bag  
Bolsa interna  
Sacoche interne  
Innentasche  
Borsa interna  
Bolsa interna



Upper rack  
Parrilla superior  
Support porte-bagage  
Gepäckgitter  
Griglia portapacchi  
Platina superior



# TOP



# CASES

15

# TOPCASES

Ref. D1B48PA



Standard Bottom  
Platina Estándar  
Platine Standard  
Standard-Adapterplatte  
Piastra Standard  
Platina Standard

Hermetic Sealing System



Motorcycle Specific Colours



Ref. D0R170



Backrest  
Respaldo  
Dossieret  
Rückenpolster  
Schienale  
Encosto

**ACCESSORY:** Ref. X0IB00



Inner bag  
Bolsa interna  
Sacoche interne  
Innentasche  
Borsa interna  
Bolsa interna



**ACCESSORY:** Ref. D0PS00



Upper rack  
Parrilla superior  
Support porte-bagage  
Gepäckgitter  
Griglia portapacchi  
Platina superior

**ACCESSORY:** Ref. D0B50KL



Light  
Luz  
Luz  
Feux  
Licht  
Luce  
Luz



Characteristics Page 12

Accessory X0IB00    Accessory D0PS00    Accessory D0B50KL



Smart Lock System



32 cm  
46 cm  
60 cm



Ref. DOB5000

Black  
Negro  
Noir  
Schwarz  
Nero  
Preto



Ref. DOB5000 + D1B50E01

Blue  
Azul  
Bleu  
Blau  
Blu  
Azul



Ref. DOB5000 + D1B50E05

Silver  
Plata  
Argent  
Silber  
Argento  
Prateado



Ref. DOB5000 + D1B50E07

Titanium  
Titanio  
Titane  
Titan  
Titânio



Ref. DOB5000 + D1B50E08

White  
Blanco  
Blanc  
Weiß  
Bianco  
Branco



Ref. DOB5000 + D1B50E09

Red  
Rojo  
Rouge  
Rot  
Rosso  
Vermelho



Ref. DOB5000 + D1B50E21

Black Metal  
Negro Metalizado  
Noir Métal  
Schwarz Metallic  
Nero Metallo  
Preto Metalizado



# TOPCASES

Ref. D1B48PA



Standard Bottom  
Platina Estándar  
Platine Standard  
Standard-Adapterplatte  
Piastra Standard  
Platina Standard

Hermetic Sealing System



**ACCESSORY:** Ref. D0RI60



Backrest  
Respaldo  
Dossieret  
Rückenpolster  
Schienale  
Encosto

**ACCESSORY:** Ref. X0IB00



Inner bag  
Bolsa interna  
Sacoche interne  
Innentasche  
Borsa interna  
Bolsa interna



**ACCESSORY:** Ref. D0PS00



Upper rack  
Parrilla superior  
Support porte-bagage  
Gepäckgitter  
Griglia portapacchi  
Platina superior

**ACCESSORY:** Ref. D0B50KL



Light  
Luz  
Feux  
Licht  
Luce  
Luz



Characteristics Page 12

Accessory D0RI60

Accessory X0IB00

Accessory D0PS00

Accessory D0B50KL



Smart Lock System



# SH49

REF.DOB49100

32 cm  
46 cm  
60 cm



# TOPCASES

<p>Just standard colours available</p> 	<p>Ref. D1B48PA</p>  <p><b>INCLUDED</b></p> <p>Standard Bottom Platina Estándar Platine Standard Standard-Adapterplatte Piastra Standard Platina Standard</p>	<p>Hermetic Sealing System</p> 	<p><b>ACCESSORY:</b> Ref. D0RI4800</p>  <p>Backrest Respaldo Dossieret Rückenpolster Schienale Encosto</p>
<p><b>ACCESSORY:</b> Ref. X0IB00</p>  <p>Inner bag Bolsa interna Sacoche interne Innentasche Borsa interna Bolsa interna</p> 	<p><b>ACCESSORY:</b> Ref. D0PS00</p>  <p>Upper rack Parrilla superior Support porte-bagage Gepäckgitter Griglia portapacchi Platina superior</p>	<p><b>ACCESSORY:</b> Ref. D0B50KL</p>  <p>Light Luz Feux Licht Luce Luz</p> <p><b>APPROVED</b></p>	

Characteristics Page 12

<p>kg 8</p>				<p>Accessory D0RI4800</p> 	<p>Accessory X0IB00</p> 	<p>Accessory D0PS00</p> 	<p>Accessory D0B50KL</p> 
-------------	---	---	---	---	--	---	--



**SMART LOCK SYSTEM**



31cm  
61cm  
46cm

The lightest in its range



REF. D0B48100 [NO COVER]



Dark grey  
Gris oscuro  
Gris foncé  
Dunkelgrau  
Grigio scuro  
Cinza escuro

REF. D0B48100 + D1B48E17



Dark grey  
Gris oscuro  
Gris foncé  
Dunkelgrau  
Grigio scuro  
Cinza escuro

REF. D0B48100 + D1B48E06



Dark grey-carbon  
Gris oscuro-carbono  
Gris foncé-carbono  
Dunkelgrau-carbono  
Grigio scuro-carbono  
Cinza escuro-carbono

REF. D0B48100 + D1B48E21



Black metal  
Negro metalizado  
Noir métal  
Schwarz metallic  
Nero metallo  
Preto metalizado

REF. D0B48100 + D1B48E08



White  
Blanco  
Blanc  
Weiß  
Bianco  
Branco

REF.: D0B48200 [NO COVER]



New titanium  
New titanio  
New titane  
New titan  
New titanio  
New titânio

REF.: D0B48200 + D1B48E15



New titanium  
New titanio  
New titane  
New titan  
New titanio  
New titânio

REF.: D0B48200 + D1B48E06



New titanium-carbon  
New titanio-carbono  
New titane-carbono  
New titan-carbono  
New titanio-carbono  
New titânio-carbono

REF.: D0B48200 + D1B48E21



Black metal  
Negro metalizado  
Noir métal  
Schwarz metallic  
Nero metallo  
Preto metalizado

REF.: D0B48200 + D1B48E08



White  
Blanco  
Blanc  
Weiß  
Bianco  
Branco

# TOPCASES



Ref. D1B40PA  
Standard Bottom  
Platina Estándar  
Platine Standard  
Standard-Adapterplatte  
Plastra Standard  
Platina Standard



Motorcycle  
Specific Colours



**ACCESSORY:** Ref. X0IB00



Inner bag  
Bolsa interna  
Sacoche interne  
Innentasche  
Borsa interna  
Bolsa interna



**ACCESSORY:** Ref. D0RI50



Backrest  
Respaldo  
Dossieret  
Rückenpolster  
Schienale  
Encosto

**ACCESSORY:** Ref. D0PS00



Upper rack  
Parrilla superior  
Support porte-bagage  
Gepäckgitter  
Griglia portapacchi  
Platina superior

**ACCESSORY:** Ref. D0B40KL



Light  
Luz  
Feux  
Licht  
Luce  
Luz



Characteristics Page 12

Accessory X0IB00    Accessory D0RI50    Accessory D0PS00    Accessory D0B40KL



31 cm  
42 cm  
58 cm



Ref. D0B46100

Black  
Negro  
Noir  
Schwarz  
Nero  
Preto



Ref. D0B46100 + D1B46E01

Blue  
Azul  
Bleu  
Blau  
Blu  
Azul



Ref. D0B46100 + D1B46E05

Silver  
Plata  
Argent  
Silber  
Argento  
Prateado



Ref. D0B46100 + D1B46E07

Titanium  
Titano  
Titane  
Titan  
Titano  
Titânio



Ref. D0B46100 + D1B46E08

White  
Blanco  
Blanc  
Weiß  
Bianco  
Branco



Ref. D0B46100 + D1B46E09

Red  
Rojo  
Rouge  
Rot  
Rosso  
Vermelho



Ref. D0B46100 + D1B46E21

Black Metal  
Negro Metalizado  
Noir Métal  
Schwarz Metallic  
Nero Metallo  
Preto Metalizado



# TOPCASES



Ref. D1B40PA  
 Standard Bottom  
 Platina Estándar  
 Platine Standard  
 Standard-Adapterplatte  
 Piastra Standard  
 Platina Standard



Just Standard  
 Colours Available

**ACCESSORY:** Ref. X0IB00



Inner bag  
 Bolsa interna  
 Sacoche interne  
 Innentasche  
 Borsa interna  
 Bolsa interna



**ACCESSORY:** Ref. D0RI60



Backrest  
 Respaldo  
 Dossieret  
 Rückenpolster  
 Schienale  
 Encosto

**ACCESSORY:** Ref. D0B40KL



Light  
 Luz  
 Feux  
 Licht  
 Luce  
 Luz



Characteristics Page 12

Accessory X0IB00

Accessory D0RI60

Accessory D0B40KL





41cm  
31,4 cm  
56,4 cm



Ref. D0B45100

Black  
Negro  
Noir  
Schwarz  
Nero  
Preto



Ref. D0B45100 + D1B45E01

Blue  
Azul  
Bleu  
Blau  
Blu  
Azul



Ref. D0B45100 + D1B45E05

Silver  
Plata  
Argent  
Silber  
Argento  
Prateado



Ref. D0B45100 + D1B45E07

Titanium  
Titano  
Titane  
Titan  
Titano  
Titânio



Ref. D0B45100 + D1B45E08

White  
Blanco  
Blanc  
Weiß  
Bianco  
Branco



Ref. D0B45100 + D1B45E09

Red  
Rojo  
Rouge  
Rot  
Rosso  
Vermelho



Ref. D0B45100 + D1B45E21

Black Metal  
Negro Metalizado  
Noir Métal  
Schwarz Metallic  
Nero Metallo  
Preto Metalizado



# TOPCASES

Ref. D1B40PA



Standard Bottom  
Platina Estándar  
Platine Standard  
Standard-Adapterplatte  
Piastra Standard  
Platina Standard



**ACCESSORY:** Ref. D1RIES



Backrest  
Respaldo  
Dossieret  
Rückenpolster  
Schienale  
Encosto

**ACCESSORY:** Ref. X0IB00



Inner bag  
Bolsa interna  
Sacoche interne  
Innentasche  
Borsa interna  
Bolsa interna



**ACCESSORY:** Ref. D0B40KL



Light  
Luz  
Feux  
Licht  
Luce  
Luz



Characteristics Page 12

Accessory D1RIES

Accessory X0IB00

Accessory D0B40KL



40 cm  
28 cm  
55 cm



# TOPCASES



Ref. D1B40PA  
 Standard Bottom  
 Platina Estándar  
 Platine Standard  
 Standard-Adapterplatte  
 Piastra Standard  
 Platina Standard



Just Standard Colours Available

**ACCESSORY:** Ref. D0R160



Backrest  
 Respaldo  
 Dossieret  
 Rückenpolster  
 Schienale  
 Encosto

**ACCESSORY:** Ref. D0B40KL



Light  
 Luz  
 Feux  
 Licht  
 Luce  
 Luz



Characteristics Page 12

Accessory D0R160    Accessory D0B40KL



42,5 cm  
29,6 cm  
49,2 cm



Ref. D0B40100

Black  
Negro  
Noir  
Schwarz  
Nero  
Preto



Ref. D0B40100 + D1B40E01

Blue  
Azul  
Bleu  
Blau  
Blu  
Azul



Ref. D0B40100 + D1B40E05

Silver  
Plata  
Argent  
Silber  
Argento  
Prateado



Ref. D0B40100 + D1B40E07

Titanium  
Titânio  
Titane  
Titan  
Titanio  
Titânio



Ref. D0B40100 + D1B40E08

White  
Blanco  
Blanc  
Weiß  
Bianco  
Branco



Ref. D0B40100 + D1B40E09

Red  
Rojo  
Rouge  
Rot  
Rosso  
Vermelho



Ref. D0B40100 + D1B40E21

Black Metal  
Negro Metalizado  
Noir Métal  
Schwarz Metallic  
Nero Metallo  
Preto Metalizado



# TOPCASES



Ref. D1B40PA  
 Standard Bottom  
 Platina Estándar  
 Platine Standard  
 Standard-Adapterplatte  
 Piastra Standard  
 Platina Standard



Elastic Cord  
 Pulpo Elástico  
 Sandow  
 Gummiband  
 Elastico  
 Elástico



**ACCESSORY:** Ref. D0R160



Backrest  
 Respaldo  
 Dossieret  
 Rückenpolster  
 Schienale  
 Encosto

**ACCESSORY:** Ref. D0B40KL



Light  
 Luz  
 Feux  
 Licht  
 Luce  
 Luz



Characteristics Page 12

Accessory D0R160    Accessory D0B40KL







# SH40 CARGO

REF.D0B40199

42,5 cm  
32,5 cm  
49,2 cm



# TOPCASES



Characteristics Page 12

Accessory D0R13900 Accessory D0B40KL

4 kg

Icon: Two helmets

Icon: Downward arrow

Icon: Hexagonal color logo

Icon: Motorcycle seat

Icon: Headlight





# NEW SH39

The lightest in its range

43 cm  
32 cm  
51 cm



Ref. D0B39100

Black  
Negro  
Noir  
Schwarz  
Nero  
Preto



Ref. D0B39100+D1B39E08

White  
Blanco  
Blanc  
Weiß  
Bianco  
Branco



Ref. D0B39100+D1B39E15

New titanium  
New titanio  
New titane  
New titan  
New titanio  
New titânio



Ref. D0B39100+D1B39E06

Carbon  
Carbono  
Carbono  
Carbono  
Carbonio  
Carbono



Ref. D0B39100+D1B39E21

Black Metal  
Negro Metalizado  
Noir Métal  
Schwarz Metallic  
Nero Metallo  
Preto Metalizado



# TOPCASES



Characteristics Page 12

Accessory D0R160 Accessory D0B29KL



31 cm  
40 cm  
49 cm



Ref. DOB37100

Black  
Negro  
Noir  
Schwarz  
Nero  
Preto



Ref. DOB37100 + D1B37E01

Blue  
Azul  
Bleu  
Blau  
Blu  
Azul



Ref. DOB37100 + D1B37E05

Silver  
Plata  
Argent  
Silber  
Argento  
Prateado



Ref. DOB37100 + D1B37E07

Titanium  
Titano  
Titane  
Titan  
Titano  
Titânio



Ref. DOB37100 + D1B37E08

White  
Blanco  
Blanc  
Weiß  
Bianco  
Branco



Ref. DOB37100 + D1B37E09

Red  
Rojo  
Rouge  
Rot  
Rosso  
Vermelho



Ref. DOB37100 + D1B37E21

Black Metal  
Negro Metalizado  
Noir Métal  
Schwarz Metallic  
Nero Metallo  
Preto Metalizado





Characteristics Page 12

Accessory D0R140 Accessory D0B29KL



Ref. D0B3300

Black  
Negro  
Noir  
Schwarz  
Nero  
Preto



Ref. D0B3300  
+ D1B33E01

Blue  
Azul  
Bleu  
Blau  
Blu  
Azul



Ref. D0B3300  
+ D1B33E05

Silver  
Plata  
Argent  
Silber  
Argento  
Prateado



Ref. D0B3300  
+ D1B33E07

Titanium  
Titanio  
Titane  
Titan  
Titânio



Ref. D0B3300  
+ D1B33E08

White  
Blanco  
Blanc  
Weiß  
Bianco  
Branco



Ref. D0B3300  
+ D1B33E09

Red  
Rojo  
Rouge  
Rot  
Rosso  
Vermel



Ref. D0B3300  
+ D1B33E21

Black Metal  
Negro Metalizado  
Noir Métal  
Schwarz Metallic  
Nero Metallo  
Preto Metalizado



31 cm  
42 cm  
43 cm



Ref. D0B33100

Black  
Negro  
Noir  
Schwarz  
Nero  
Preto



Ref. D0B33100  
+ D1B33E01

Blue  
Azul  
Bleu  
Blau  
Blu  
Azul



Ref. D0B33100  
+ D1B33E05

Silver  
Plata  
Argent  
Silber  
Argento  
Prateado



Ref. D0B33100  
+ D1B33E07

Titanium  
Titanio  
Titane  
Titan  
Titânio



Ref. D0B33100  
+ D1B33E08

White  
Blanco  
Blanc  
Weiß  
Bianco  
Branco



Ref. D0B33100  
+ D1B33E09

Red  
Rojo  
Rouge  
Rot  
Rosso  
Vermelho



Ref. D0B33100  
+ D1B33E21

Black Metal  
Negro Metalizado  
Noir Métal  
Schwarz Metallic  
Nero Metallo  
Preto Metalizado



→ Just Standard Colours Available

Ref. D1B29PA

Standard Bottom  
Platina Estándar  
Platine Standard  
Standard-Adapterplatte  
Piastra Standard  
Platina Standard



**ACCESSORY:** Ref. D0R140

Backrest  
Respaldo  
Dossieret  
Rückenpolster  
Schienale  
Encosto



**ACCESSORY:** Ref. D0B29KL

Light  
Luz  
Feux  
Light  
Luce  
Luz



# TOPCASES



Ref. D1B29PA

Standard Bottom  
Platina Estándar  
Platine Standard  
Standard-Adapterplatte  
Plastra Standard  
Platina Standard



Just Standard Colours Available

**ACCESSORY:** Ref. D0R140



Backrest  
Respaldo  
Dossieret  
Rückenpolster  
Schienale  
Encosto

**ACCESSORY:** Ref. D0B29KL



Light  
Luz  
Feux  
Licht  
Luce  
Luz



Characteristics Page 12

Accessory D0R140    Accessory D0B29KL



38 cm  
30 cm  
40 cm



Ref. D0B29100

Black  
Negro  
Noir  
Schwarz  
Nero  
Preto



Ref. D0B29100 + D1B29E01

Blue  
Azul  
Bleu  
Blau  
Blu  
Azul



Ref. D0B29100 + D1B29E05

Silver  
Plata  
Argent  
Silber  
Argento  
Prateado



Ref. D0B29100 + D1B29E07

Titanium  
Titanio  
Titane  
Titan  
Titanio  
Titânio



Ref. D0B29100 + D1B29E08

White  
Blanco  
Blanc  
Weiß  
Bianco  
Branco



Ref. D0B29100 + D1B29E09

Red  
Rojo  
Rouge  
Rot  
Rosso  
Vermelho



Ref. D0B29100 + D1B29E21

Black Metal  
Negro Metalizado  
Noir Métal  
Schwarz Metallic  
Nero Metallo  
Preto Metalizado



# TOPCASES



Ref. D1B29PA

- Standard Bottom
- Platina Estándar
- Platine Standard
- Standard-Adapterplatte
- Piastra Standard
- Platina Standard



**ACCESSORY:** Ref. DOB29KL



- Light
- Luz
- Feux
- Licht
- Luce
- Luz



Characteristics Page 12

Accessory DOB29KL





282 cm  
40,5 cm  
40 cm





**SIDE**

**CASES**



43

# SIDECASES

Reflector  
Sidecase

# SH43 RED



Characteristics Page 12

Accessory X0IB00

kg 5



2 SIDE CASES



**FULL EQUIPMENT**

1 TOP CASE +  
2 SIDE CASES



**Greatest CAPACITY**

**ACCESSORY:** Ref. X0IB00



50 cm  
35 cm  
21 cm



Inner bag  
Bolsa interna  
Sacoche interne  
Innentasche  
Borsa interna  
Bolsa interna

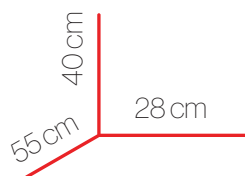

Ref. RED REFLECTOR  
DOB4310 + D1B43E00

Ref. WHITE REFLECTOR  
DOB43100 + D1B43E00

Black  
Negro  
Noir  
Schwarz  
Nero  
Preto



Ref. RED REFLECTOR  
DOB4310 + D1B43E01

Ref. WHITE REFLECTOR  
DOB43100 + D1B43E01

Blue  
Azul  
Bleu  
Blau  
Blu  
Azul



Ref. RED REFLECTOR  
DOB4310 + D1B43E05

Ref. WHITE REFLECTOR  
DOB43100 + D1B43E05

Silver  
Plata  
Argent  
Silber  
Argento  
Prateado



Ref. RED REFLECTOR  
DOB4310 + D1B43E07

Ref. WHITE REFLECTOR  
DOB43100 + D1B43E07

Titanium  
Titano  
Titane  
Titan  
Titano  
Titânio



Ref. RED REFLECTOR  
DOB4310 + D1B43E08

Ref. WHITE REFLECTOR  
DOB43100 + D1B43E08

White  
Blanco  
Blanc  
Weiß  
Bianco  
Branco



Ref. RED REFLECTOR  
DOB4310 + D1B43E17

Ref. WHITE REFLECTOR  
DOB43100 + D1B43E17

Dark Grey  
Gris Oscuro  
Gris Foncé  
Dunkelgrau  
Grigio Scuro  
Cinza Escuro



Ref. RED REFLECTOR  
DOB4310 + D1B43E09

Ref. WHITE REFLECTOR  
DOB43100 + D1B43E09

Red  
Rojo  
Rouge  
Rot  
Rosso  
Vermelho



Ref. RED REFLECTOR  
DOB4310 + D1B43E15

Ref. WHITE REFLECTOR  
DOB43100 + D1B43E15

New Titanium  
New Titano  
New Titane  
New Titan  
New Titano  
New Titânio



Ref. RED REFLECTOR  
DOB4310 + D1B43E21

Ref. WHITE REFLECTOR  
DOB43100 + D1B43E21

Black Metal  
Negro Metalizado  
Noir Métal  
Schwarz Metallic  
Nero Metallo  
Preto Metalizado



# SIDE CASES

Characteristics Page 12

Accessory X0IB00

kg 5



**ACCESSORY:** Ref. X0IB00



Inner bag  
Bolsa interna  
Sacoche interne  
Innentasche  
Borsa interna  
Bolsa interna

37L

85 cm  
50 cm  
21 cm



Sidecase **SH42**  
REF. DOBS00



—● Inner tray



# SIDE CASES



• Patent Pending

**ACCESSORY:** Ref. X0IB36



Inner bag  
Bolsa interna  
Sacoche interne  
Innentasche  
Borsa interna  
Bolsa interna



**ACCESSORY:** Ref. D1B36CAR



Red reflector  
Reflector rojo  
Réflecteur rouge  
Rot reflektor  
Ratarifrangente rosso  
Refletor vermelho

Characteristics Page 12

Accessory X0IB36





# NEW SH36

38 cm  
33 cm  
49 cm

The lightest in its range



Ref. DOB36100

Black  
Negro  
Noir  
Schwarz  
Nero  
Preto



Ref. DOB36100+D1B36E06

Carbon  
Carbono  
Carbono  
Carbono  
Carbono  
Carbono



Ref. DOB36100+D1B36E08

White  
Blanco  
Blanc  
Weiß  
Bianco  
Branco



Ref. DOB36100+D1B36E15

New titanium  
New titanio  
New titane  
New titan  
New titanio  
New titânio



Ref. DOB36100+D1B36E17

Dark grey-carbon  
Gris oscuro-carbono  
Gris foncé-carbono  
Dunkelgrau-carbono  
Grigio scuro-carbono  
Cinza escuro-carbono





# Fitting Kits



51

• SHAD offers a large range of backrests developed for the main scooters on the market. High-quality backrests with upholstery finishing, which improve the comfort of the rider.

• SHAD dispone de una amplia gama de modelos adaptables a los principales scooters del mercado. Respaldos de alta calidad con acabados en tapicería, que mejoran la comodidad del pasajero.

• SHAD dispose d'une haute gamme de modèles adaptables sur les principaux scooters du marché. Dossierets de haute qualité avec finissons en tapisserie, qui améliorent le confort du passager.

• SHAD bietet für viele Scootermodelle mit hohem Marktanteil eine breite Modellpalette von Backrests an. Der Komfort wird mit diesen gepolsterten Rückenlehnen erheblich verbessert.

• SHAD offre un' ampia gamma di modelli adattabili ai principali scooter del mercato. Offre inoltre schienalini di alta qualità con rifiniture in tappezzeria che migliorano la comodità del passeggero. Schienalini custom di alta qualità e rifiniture in tessuto che migliorano la comodità del passeggero.

• A SHAD possui uma ampla gama de modelos adaptáveis aos principais modelos de scooter do mercado. Encostos de alta qualidade com acabamentos em tapeçaria que melhoram o conforto do garupa.



MODEL	BACKREST REF.
<b>AEON</b>	
ELITE 125/350i (2013-14)	B0NZ33RN
URBAN 125/350i (2013-14)	B0NZ33RN
<b>APRILIA</b>	
SCARABEO 125/200 (08-12)	A0SC18RN
<b>BENELLO</b>	
ZENCERO 125/350 (12-14)	B0ZN33RN
<b>GILERA</b>	
NEXUS 125 (07-14)	G0NX18RN
NEXUS 250 / 500 (06 - 14 / NEXUS 300 (13-14)	G0NX18RN
FUOCO 500 (07-14)	G0FC58RN (08-13)
GP 800 (08-14)	G0GP88RN
<b>HONDA</b>	
SH125 / SH150 / Pasion / (05 - 08)	H0SH15RN
FORESIGHT-PANTHEON 125/150 (98 - 02)	*H0F28R
PCX 125 (10-15)	H0PC10RN
FORESIGHT 250 (98 - 08)	*H0F28R
FORZA 250 (05 - 07)	H0FR26RN
<b>KAWASAKI</b>	
J300 (13-14)	K0J334RN
<b>KYMCO</b>	
SUPER DINK/STREET-DOWNTOWN 125 / 300 (09-14)	K0SP19RN
XCITING 250/500 (05 - 11)	K0XC55RN
K-XCT 125/300i (2013)	K0XC32RN
XCITING 400 (2013-14)	K0XC42RN
XCITING 500 ABS (05-12) / 500iR (10-14)	K0XC55RN
MY ROAD 700i (2012-14)	K0MY72RN
<b>PEUGEOT</b>	
ELYSEO 50/100 (98 - 02)	P0E58R
ELYSTAR 50/125/150 (02 - 12)	P0E58R
ELYSEO 125/150 (98 - 04)	P0E58R
<b>PIAGGIO</b>	
BEVERLY TOURER 125/250/400 (08 - 14)	*V0TR18RN
BEVERLY 125ie / 300ie TOURER/tourer sport 330(13) (11-14)	*V0TR18RN
FLY 50/125/150 (05 - 12)	V0FL15RN
X7 125/250/300 (08-14)	VOX718RN
X7 125/250/300 EVO (10-14)	VOXV30RN
X8 125/250-500 7 / XEVO 125/250 (04 - 08) "Abatable"	VOX815RN
X9 125/180/250/500 (00 - 09)	VOX20R
X10 (12-14)	VOX112RN
X10 (12-14)	VOX112RN/7
BEVERLY CRUISER 500 (07-14)	*V0BV57RN
<b>QUADRO</b>	
3D 350 (2012-14)	B0ZN33RN
<b>SUZUKI</b>	
BURGMAN 125/150 (02 - 06)	S0BR12RN
BURGMAN 125/150 (02 - 06)	S0BR12R (02)
BURGMAN UH 125/ 200 125 R (07-13)	S0BR17RN
BURGMAN 125/200 (2014)	S0BR17RN
BURGMAN 400 X Tipe S (05 - 06)	S0BR45RN
BURGMAN 400 K7 (06)	S0BR46RN
BURGMAN 400 (07-09)	S0BR46RN
BURGMAN 400 Z (07) Enlever dossier original	S0BR46RN
BURGMAN 400 ABS (10-13)	S0BR46RN
<b>TGB</b>	
X MOTION 125-250i-300i/ X LARGE 125i (09-14)	TOXM19RN
<b>YAMAHA</b>	
NEO'S 50 / 100 (97 - 07)	*Y0N10R
MAJESTY 125 (98 - 00)	Y0M18R
MAJESTY 125/150/180 (01 - 06)	Y0M11R
MAJESTY 125 (07-10)	Y0M11R
X-MAX 125-250 (05 - 09)	Y0XM25RN
X-MAX 125-250 (10-13)	Y0XM20RN(10-13)
X-MAX 125-250 (10-13)	Y0XM20RN/15
X-MAX 125/250/400 i (2014)	Y0XM43RN
MAJESTY 400 (04 - 06)	Y0MJ44RN
MAJESTY YP400 (10-13)	Y0MJ44RN
X-MAX125- 400i (2014)	Y0XM43RN
X-MAX125- 400i (2014)	Y0XM43RN/15
T- MAX XP500 (01-07)	Y0T51RN
T-MAX XP500 /ABS (08-12)	Y0TM58RN

**NEW**

Discover the new range of

**SHAD**

*style*



BRAND	REFERENCE	COLOUR
<b>YAMAHA</b>		
X-MAX 125/250 (10-12)	Y0XM20RN/15	Black, with golden seams
X-MAX 400	Y0XM43RN/15	Black, with golden seams
<b>PIAGGIO</b>		
X-10 (12-13)	VOX112RN/7	Brown, with brown seams

# Sissybars & CHROMED RACKS

•High quality sissybars with upholstery finishing, which improve the comfort of the rider. The sissybar makes possible to place the chromed rack to fix a top case.

•Respaldos custom de alta calidad y acabados en tapicería, que mejoran la comodidad del pasajero. El sissybar permite acoplar el portapaquetes para colocar una maleta.

•Dossierets custom de haute gamme et finissons en tapisserie, qui améliorent le confort du passager. Le Sissybar permet adapter le porte- paquet pour mettre un top case.

•Gepolsterte Custom Rückenlehne in qualitativ hochwertiger Ausführung mit maximalem Komfort für den Sozius. Auf das Modell Sissybar kann eine Gepäckplatte für die Befestigung eines Top-case montiert werden.

•Schienalini custom di alta qualità e rifiniture in tappezzeria che migliorano la comodità del passeggero. Il sissybar permette di unire il portapacchi per collocare un bauletto.

•Encostos custom de alta qualidade com acabamentos em tapeçaria que melhoram o conforto do garupa. O sissybar permite fixar um bagageiro para instalar uma mala.

BRAND & MODEL	SISSYBAR REF.	1 TOP CASE (CHROMED RACK REF.)
<b>DAELIM</b>		
DAYSTAR 125 (00-14)	D0D10SN	NADTN + D0D10SN
<b>HONDA</b>		
REBEL 125/250 (96-13)	H0R16SN	NADTN+H0R16SN
SHADOW 125 (99-13)	H0S19SN	NADTN+H0S19SN
SHADOW 600 (95-04)	H0S65SN	NADTN+H0S65SN
<b>HYOSUNG</b>		
AQUILA 125 / GV 250 (06-13)	H0QL17SN	NADTN + H0QL17SN
<b>KAWASAKI</b>		
VULCAN 900/900 CLASSIC (07-13)	*K0VL97SN	NADTN + K0VL97SN
<b>KEEWAY</b>		
SUPERLIGHT 125 (11-14)	K0SP11SN	NADTN + K0SP11SN
<b>SUZUKI</b>		
INTRUDER 125 / 250 (99-09)	S0H9SN	NADTN + S0H9SN
INTRUDER 125 (11-12)	-----FITS DIRECTY-----	-----
MARAUDER 125 / 250 (98-13)	S0M18SN	NADTN + S0M18SN
<b>YAMAHA</b>		
XV125/250 VIRAGO (94-13)	Y0V25SN	NADTN + Y0V25SN
DRAGSTAR CLASSIC 125/250 (99-08)	Y0D19SN	NADTN + Y0D19SN
XV535 VIRAGO (95-04)	Y0V55SN	NADTN + Y0V55SN



## CHROMED RACKS

## SISSYBARS



# FITTING KITS

# New SPORT RACK



BRANDS, MODELS & YEARS	SPORT RACK REF.
<b>HONDA</b>	
CB 1000R (09-11)	HOCB11CL
<b>KAWASAKI</b>	
Z 750 (07-12)	KOZ778CL
Z 1000 (07-09)	KOZ778CL
<b>YAMAHA</b>	
FAZER FZ8 (10-12)	Y0FZ80CL



## IT'S FAST, IT'S USEFUL

Step 1



Step 2



Step 3



Real example



**No FITTING KITS required!**  
Valid for all SHAD Top Cases

# Attachment **SUPPORTS**

## TOP & SIDE MASTER



Top master  
Tubular

1 Top case



Side Master

2 Side Cases



Top master  
Tubular  
Side Master

1 Top case +  
Side Cases



- One of SHAD's most important innovations. The new 3P System side kit has been specifically created for this occasion, and while developing it, not only aesthetics were in mind. The key point to be considered was safety.

- Integrated design: The side mounting is better integrated with the bike.
- Lightness: reducing the overall weight thanks to the reduction of iron needed, improving security.
- Easy to assemble.
- Patent Pending

- Una de las innovaciones más importantes de SHAD. El nuevo sistema de fijación lateral 3P System ha sido creado por SHAD para esta ocasión. En su desarrollo no sólo se ha primado la estética, sino que se ha tenido muy en cuenta la seguridad.

- Diseño integrado: la fijación lateral queda mejor integrada en la moto.
- Ligereza: gracias a la reducción de material necesario, lo que mejora la seguridad.
- Fácil de montar.
- Pendiente de patente.

- Une des innovations les plus importantes de SHAD. Le nouveau système de fixation latérale 3P a été créé par SHAD pour cette occasion. Et en le développant, non seulement l'esthétique étaient à l'esprit. Le point clé a toujours été la sécurité.

- Design intégré: la fixation latérale est mieux intégré à la moto.
- Légèreté: la réduction du poids grâce à la réduction du fer nécessaire, améliorant la sécurité.
- Facile à assembler.
- Patente à confirmer.





BRAND & MODEL	TOPMASTER	SIDEMASTER	3P SYSTEM
<b>LAMBRETTA</b>			
LAMBRETTA 125 (12-14)	L0LM12ST		
<b>MALAGUTTI</b>			
MADISON 3 125 / 250 (07-09)	M0MD17ST		
MADISON 3 125ie / 250ie (11-14)	M0MD17ST		
MADISON 125-150-180-250-400 (99-06)	M0M19T		
SPIDERMAX GT 500 (07-14)	M0SP57ST		
<b>PEUGEOT</b>			
LUDDIX 50 (04-12 / LUDDIX ONE 50 (10)	P0LD54ST		
KISBEERS 50(2013-14 / KYSBEE 100 (2014)	P0KS53ST		
SPEEDFIGHT (97-03)	P0PF57T		
SV50-SV80-SV125 (95-03)	P0V55T		
VIVACITY 50 / 100 (99-07)	P0V59T		
ELYSEO 50/100 (98-02)	P0E18T		
ELYSTAR 50/125/150 (02-12)	P0LS52ST		
CITYSTAR 125/200i (2012-14 / CITYSTAR 50 (2013-14)	P0CT12ST		
ELYSEO 125/150 (98-04)	P0E58T		
SATELLIS 125/200/400/500 (10-14 monter fixation original	P0ST10ST		
TWEET 50/ 125 (10-14)	P0TW10ST		
SV250 (03-04)	H0F28T		
<b>PIAGGIO</b>			
ENERGY / EXTREME 50 (99-04)	V0E59T		
ENERGY NRG 50 (05-14)	V0NR55ST		
LX 50/125 (05-08)	V0LX55ST		
TYPHOON 50 (99-03)	V0T59T		
TYPHOON 50/125 (11-14)	V0TH11ST		
ZIP 50 (09-14)	V0ZP59ST		
CARNABY 125 (08-10) / CARNABY 200/250 (09-14)	V0CR18ST		
VESPA ET4 50/125/150 (97-03)	*V0V17T		
LIBERTY 50/125/200 (05-08)	V0LB15ST		
LIBERTY 50/125 (09-14)	V0LB19ST		
LIBERTY S 50/125/200 (07-09)	V0LB17ST		
SKYPPER 125/300 (03-04)	V0SK12ST		
BEVERLY TOURER 125/250/400 (08-14)	V0TR18ST		
BEVERLY 125ie / 300 ie TOURER/tourer sport.330(13) (11-14)	V0TR18ST		
FLY 50/125/150 (05-12)	V0FL15ST		
FLY 50/125/150 (2013-14)	V0FL13ST		
X7 125/250/300 (08-14)	V0X718ST		
X7 125/250/300 EVO (10-14)	V0X718ST		
X8 125/250-500 7 / XEVO 125/250 (04-08) "Abatable"	V0X814ST		
X9 125/180/250/500 (00-09)	V0X20T		
X10 (12-14)	V0X112ST		
BEVERLY 125/200/500 (02-08)	V0BV22ST		
MP3 125RL/300/400/500 LT-SPORT-HYBRID 125/300 LT (07-14)	V0MP10ST		
MP3 125/300 YOURBAN (11-14)	V0YR11ST		
MP3 YOURBAN LT300 ie (11-14)	V0YR11ST		
BEVERLY CRUISER 500 (07-14)	*V0BV57ST		
<b>QUADRO</b>			
3D 350 (2012-14)	Q03D32ST		
<b>SUZUKI</b>			
ADDRESS 50R (94-04)	S0A54T		
ADDRESS 125 (07-10)	S0DR18ST		
KATANA 50LC (97-04)	S0K57T		
EPICURO 125 / 150 (99-03)	*S0E19T		
TUXI25 (99-03)	*S0T19T		
TU125 Superclassic (99-02)	*S0T19T		
SIXTEEN 125 (08-10)	S0SX18ST		
SIXTEEN 150 (10-14)	S0SX18ST		
BURGMAN 125/150 (02-06)	S0BR12ST		
BURGMAN UH 125 / 200 125R (07-13)	S0BR17ST		
BURGMAN 125/200 (2014)	S0BR17ST		
INAZUMA 250 (2013-14)	S0NZ23ST		
BURGMAN 250 (98-00)	S0S28T		
BURGMAN 250/BUSINESS (01-09)	S0S21T		
BURGMAN 400 (98-00)	S0S28T		
BURGMAN 400 (01-06)	S0S21T		
BURGMAN 400 X Tipe S (05-06)	S0BR45ST		
BURGMAN 400 K7 (06)	S0BR46ST		
BURGMAN 400 (07-09)	S0BR46ST		
BURGMAN 400 Z (07) Enlever dossier original	S0BR46ST		
BURGMAN 400 ABS (10-13)	S0BR46ST		
INAZUMA GSX 400F (00)	S0I78T		
GS500 E (89-00)	S0G54T		
GS 500 / GS 500 F (01-11)	S0GS51ST	*S0GS51SF	
GSR-600 (05-11)	S0GS66ST	S0GS66SF	
GSX600F (98-04)	S0G78T		
BANDIT GSF600 N (94-99)	S0B64T		
BANDIT GSF600 (00-04)	S0BN60ST	*S0BN60SF	
BANDIT 650 N/S GSX650 (05-14)	S0BN69ST	S0BN65SF(05-06 & 2009)	
BANDIT 650 N/S GSX650 (05-14)	S0BN69ST	S0BN67SF (07-10)	
BANDIT GSX 650 F (08-14)	S0BN69ST	S0BN67SF	
BANDIT 650 S ABS (11-14)	S0BN69ST	S0BN61SF	SOBN61IF
BANDIT GSX650 F (11-14)	S0BN69ST	S0BN61SF	
BURGMAN 650 (02-14)	S0BR62ST		
BURGMAN 650 EXECUTIVE (04-14)	S0BR62ST (I)		
FREEWIND XF650 (97-03)	*S0F67T		
DR650RSE (91-96)	FITS DIRECTLY		
V-STROM DL 650 (04-11)	S0VS12ST	S0VS64SF	
V-STROM 650 ABS (12-14)	S0VS62ST	S0VS62SF	
SV650 (99-02)	S0SV69ST		
SV650 S (03-11)	S0SV13ST		
GSX 650 F (2011)	S0BN69ST	S0GS61SF	
GLADIUS 650 (09-14)	S0GL69ST		
GSR 750 (11-14)	S0GS71ST		
GSX750FS (91-98)	S0S74T		
GSX 600/750 F (03-07)	S0GS74ST	S0GS74SF + D1BNFL	
BANDIT 750 (96-97)	S0B64T		
GSX 750 F (98-02)	S0G78T		
INAZUMA GSX750 (98-03)	S0I78T		
V-STROM DL 1000 (02-13)	S0VS12ST	S0VS12SF	
V-STROM DL 1000 (2014)	S0VS14ST		SOVS14IF
SV1000 S (03-09)	S0SV13ST		
INAZUMA GSX1200 (99-03)	S0I78T		
BANDIT 1200 N/S (96-00)	S0B64T		
BANDIT 1200 / N/S (01-04)	S0BN60ST		
BANDIT GSF 1200 / S (05-14)	S0BN69ST		
BANDIT GSX1250 N/FA (11-14)	S0BN69ST		
BANDIT GSF 1250 / (07-09)	S0BN69ST		
GSX 1400 (01-07)	S0BN11ST	*S0BN11SF(01/04)	
GSX 1400 (01-07)	S0BN11ST	S0GS16SF (05/07)	

BRAND & MODEL	TOPMASTER	SIDEMASTER	3P SYSTEM
<b>SYM</b>			
FIDDLE II 50 / 125 (2011-14)	S0FD11ST		
ALLO 125 (11-14)	S0LL51ST		
CITY COM 125i / 300i (11-14)	S0CT31ST		
JOYRIDE 125/200 EVO (10-14)	S0JR11ST		
WOLF SB 125i / 250i (2012-13)	S0WL12ST		
GTS 125 / 250 (06-11)	S0GT25ST		
GTS 125 / 250 / 300 EVO - EVO Fi (10-14)	S0GT25ST		
JOYMAX GTS 125 / 125i / 250i / 300i / Evo (13-14)	S0JM13ST		
EVO VS 125 (08)	*S0VS18ST		
MAXSYM 400 (11-14)	S0MX41ST		
MAXSYM 600 (2014)	S0MX41ST		
<b>TGB</b>			
X MOTION 125-250i-300i / X LARGE 125i (09-14)	T0XM19ST		
BELLA VISTA 300 efi (2012-14)	T0BL32ST		
<b>TRIUMPH</b>			
STREET TRIPLE 675 (09-13)	T0ST69ST		
TIGER 800 / 800 XC (11-13)	T0TG81ST		
SPRINT GT 1050 (11-13)	T0SP10ST		
TIGER 1050 (09-13)	T0TG19ST		
TIGER SPORT 1050 (13-14)	T0TG13ST		
TIGER EXPLORER 1200 (2012-14)	FITS DIRECTLY	T0XP12SF	
TROPHY 1300 (2013-14)	T0TR13ST		
<b>YAMAHA</b>			
NEO S 50 / 100 (97-07)	Y0NI0T		
NEO S 50 / 125 / 4 TEMPI (08-14)	Y0NS58ST		
AEROX 50/100 (97-08)	Y0A57T		
AEROX 50 (13-14)	Y0RX53ST		
WHY 50 (08-13)	FITS DIRECTLY		
JOG II 50 (02-14)	Y0JG52ST		
BW 'S 125 (10-14)	Y0BW10ST		
CYGNUS X 125 (04-06)	Y0CY14ST		
CYGNUS X 125 (07-14)	Y0CY17ST		
X - CITY 250 (07-08)	Y0XC27ST		
X-CITY 50/125/250 (09-14)	Y0XC19ST		
SR125 (96-04)	Y0S16T		
TDR125 (97-05)	Y0T17T		
XT 125 R/X (05-10)	Y0XT15ST		
YBR125 (05-07)	Y0YB15ST		
YBR 125i / CLASSIC SP (10-14)	FITS DIRECTLY		
MAJESTY 125 (98-00)	Y0M18T		
MAJESTY 125/150/180 (01-06)	Y0M11T		
MAJESTY 125 (07-10)	Y0MJ17ST		
MAJESTY 250 (96-99)	Y0M26T		
MAJESTY 250 (00-09)	Y0M20T		
SR250 Esp. (91-95)	Y0S24T		
SR250 CLASSIC (96-03)	*Y0C27T		
X-MAX 125-250 (05-09)	Y0XM25ST		
X-MAX 125-250 (10-13)	Y0XM20ST		
X-MAX 125/250/400i (2014)	Y0XM43ST		
DELIGHT 125 (13-14)	Y0DL53ST		
X CENTER 125 (12-14)	Y0XN13ST		
YBR 250 (08-12)	Y0YB28ST		
VERSITY 300 (03-07)	Y0VR33ST		
MAJESTY 400 (04-06)	Y0MJ44ST		
MAJESTY YP400 (10-13)	Y0MJ44ST		
X-MAX125-400i (2014)	Y0XM43ST		
T-MAX XP500 (01-07)	Y0T51T		
T-MAX XP500 / ABS (08-12)	Y0TM59ST		
T-MAX 530 (2012-14)	Y0TM52ST		
DIVERSION XJ 600 SN (93-95)	Y0X64T		
DIVERSION XJ 600 S/S/N (96-05)	Y0XJ66ST	*Y0XJ66SF	
DIVERSION XJ 600 N/S/F ABS (09-14)	Y0XJ69ST	Y0XJ69SF	Y0XJ69IF
XT 600 E (91-94)	Y0X61T		
XT 600 E (95-04)	Y0X65T		
XT 660 X/T (04-14)	Y0XT64ST		
TENERE XT 660Z (08-14)	Y0XT68ST	Y0XT68SF	
FAZER 600 (98-00)	Y0F68T		
FAZER 600 (01-03)	Y0FZ61ST	Y0FZ61SF	
FAZER FZ6 N/S 600 (04-06)	Y0FZ64ST	Y0FZ64SF	
FAZER FZ6 N/S 600 (07-12)	Y0FZ64ST	Y0FZ67SF	
MT 07 (2014)	Y0MT74ST		Y0MT74IF
FAZER FZ8 800 (10-14)	Y0FZ80ST		
TDM 850 (91-95)	Y0T84T	Y0T84F + D1BNFL	
TDM 850 (96-01)	Y0T86T	Y0T84F + D1BNFL	
TDM 900 (02-13)	Y0TD92ST	*Y0TD92SF	
DIVERSION XJ 900 SN (94-03)	Y0XJ94ST	*Y0XJ94SF	
MT 09 (13-14)	Y0M93ST		Y0MT93IF
FAZER 1000 (01-05)	Y0FZ11ST	*Y0FZ11SF	
FAZER 1000 - FZ1 (06-14)	Y0FZ16ST		
BULLDOG 1100 (02-08)	Y0BL12ST		
XT 1200 Z SUPER TENERE 1200 (10-13)	Y0XT10ST		
FJR 1300 (01-05)	Y0FJ31ST	Y0FJ31SF	
FJR 1300 (06-14)	Y0FJ16ST		
XJR 1300 (98-03)	Y0XJ11ST	Y0XJ11SF	
XJR 1300 (04-06)	Y0XJ11ST	Y0XJ14SF	
XJR 1300 (07-14)	Y0XJ17ST	Y0XJ17SF	

Consulte la lista actualizada en nuestra web:  
 / Check the updated list at our website:  
 / Consultez la liste actualisée sur notre site:

[www.shad.es](http://www.shad.es)

**Best Materials**  
Resistant to



SKAY

A red line with an arrowhead pointing to the top layer of a seat's cross-section, which is a dark, textured material.

**BASF**  
The Chemical Company



**SHAD**  
*style*

**Comfort  
seats**

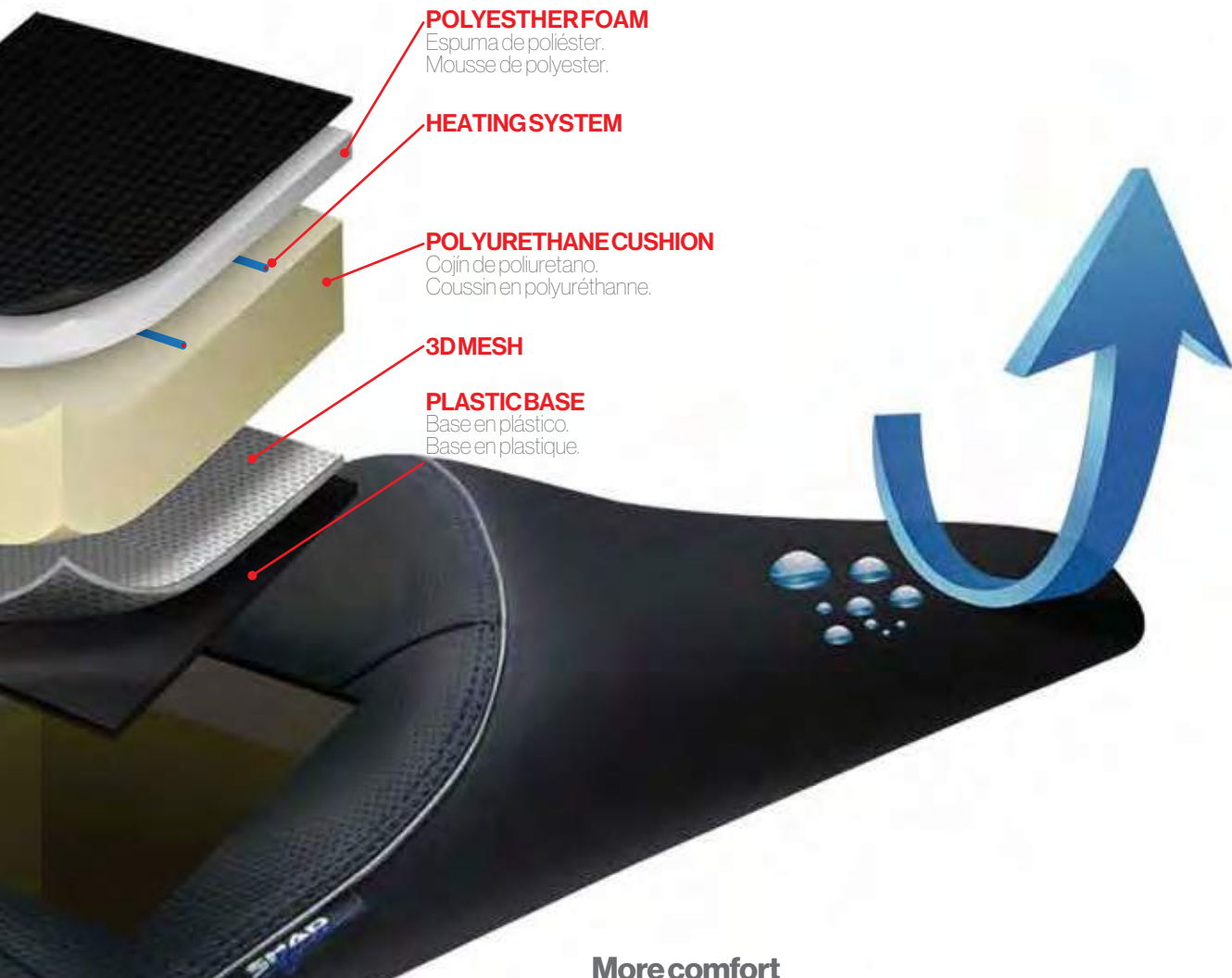

**POLYESTHERFOAM**

Espuma de poliéster.  
Mousse de polyester.

**HEATING SYSTEM**

**POLYURETHANE CUSHION**

Cojín de poliuretano.  
Coussin en polyuréthane.

**3DMESH**

**PLASTIC BASE**

Base en plástico.  
Base en plastique.



**More comfort**

Pressure redistribution by increasing contact surface.

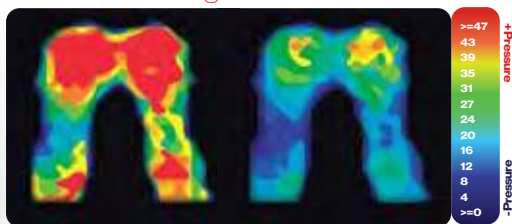

OTHER SEATS IN THE MARKET

COMFORT SEATS BY SHAD STYLE

**Better pressure distribution.**

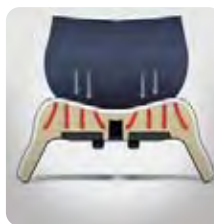

Model and year  
X MAX 125/250 (10-13)  
SKYCRUISER 125/250 (10-13)



REF.SHYOX2000

Colours. Black, with dark grey seams

REF.SHYOX2010

Colours. Black, with red seams

REF.SHYOX2006

Colours. Black-grey, with grey seams

Model and year  
T-MAX 500 (08-13)



REF.SHYOT5000

Colours. Black, with dark grey seams

REF.SHYOT5010

Colours. Black, with red seams

REF.SHYOT5006

Colours. Black-grey, with grey seams

REF.SHYOT5320

Colours. Black, with white seams

REF.SHYOT5329

Colours. Black-red, with grey seams

Model and year  
FAZER FZ6 600 (04-10)

# Yamaha

## FAZER FZ6

REF.SHY0F7000



REF.SHY0F7000

Colours. Black, with  
grey seams

Model and year  
FAZER FZ8 (13-14)

# Yamaha

## FAZER FZ 8

REF.SHY0F815C



REF.SHY0F810C

Colours. Black, with  
blue seams



REF.SHY0F811C

Colours. Black, with  
grey seams



REF.SHY0F812C

Colours. Black, with  
white seams

Model and year  
XJ6 (09-13)

REF.SHYOX6100



REF.SHYOX6100

Colours: Black, with dark grey seams

Model and year  
MT-09 (2013)

REF.SHYOM9300



REF. SHYOM9300

Colours: Black-grey, with grey seams

# Kawasaki

## Z750/1000

REF. SHK0Z1015C

Model and year  
Z750 (07-13)/Z1000 (07-09)



REF. SHK0Z1000C

Colours. Black, with dark grey seams



REF. SHK0Z1020C

Colours. Black, with red seams



REF. SHK0Z1007C

Colours. Black, with green seams



REF. SHK0Z1015C

Colours. Black with golden seams

# Kawasaki

## Z800

REF. SHK0Z8309C

Model and year  
Z800 (2013-14)



**NEW**



REF. SHK0Z8300C

Colours. Black, with dark grey seams



REF. SHK0Z8307C

Colours. Black-green, green seams



REF. SHK0Z8309C

Colours. Black-red, with red seams

Model and year  
ER-6 (12-13)

**ER6**

REF. SHK0E6300C



REF. SHK0E6300C

Colours.Black-grey, with  
grey seams

Model and year  
ER6 (09-11)

**ER6**

REF. SHK0E6000



REF. SHK0E6000

Colours.Black, with  
grey seams

REF. SHK0E6107

Colours.Black, with  
green seams



# Suzuki

## BANDIT

REF.SHS0B610C

Model and year  
SUZUKI BANDIT 650 / 1250 N  
(08-12)



REF.SHS0B610C

Colours.Black, with  
grey seams

# Suzuki

## GLADIUS

REF.SHS0G6020

Model and year  
GLADIUS (09-12)



REF.SHS0G6000

Colours.Black, with dark  
grey seams

REF.SHS0G6010

Colours.Black-grey, with  
red seams

REF.SHS0G6020

Colours.Black-white, with  
white seams

Model and year  
GSR750 (11-13)

**Suzuki**  
**GSR750**  
REF. SHS0G720C



REF. SHS0G720C

Colours.Black, with dark grey seams

REF. SHS0G721C

Colours.Black, with red seams

Model and year  
HONDA HORNET  
CB600F (11-12)

**Honda**  
**HORNET**  
REF. SHH0H6115



REF. SHH0H6100

Colours.Black, with grey seams

REF. SHH0H6115

Colours.Black, with golden seams

# Honda

## CBF

REF.SHH0C111C

Model and year  
HONDA CBF600 (09-12)  
CBF1000 (2012)



REF.SHH0C111C

Colours.Black, with  
grey seams

# Honda

## CBR600

REF.SHH0B6209

Model and year  
HONDA CBR600F (11-12)



REF.SHH0B6200

Colours.Black, with  
grey seams



REF.SHH0B6209

Colours.Black, with  
red seams



REF.SHH0B6201

Colours.Black, with  
blue seams

Model and year  
NC700X (12-13)  
NC750X (2014)

# Honda NC700X

REF. SHH0N710C



REF. SHH0N710C  
Colours. Black-grey,  
red seams



REF. SHH0N720C  
Colours. Black-grey,  
grey seams



REF. SHH0N710CN  
Colours. Black-grey,  
red seams, without logo



REF. SHH0N720CN  
Colours. Black-grey,  
grey seams, without logo

Model and year  
NC700S (12-13)  
NC750S (2014)

# Honda NC700S

REF. SHH0NS709C



**NEW**



REF. SHH0NS700C  
Colours. Black, grey seams

**NEW**



REF. SHH0NS709C  
Colours. Black, red seams

**NEW**



REF. SHH0NS700CN  
Colours. Black-grey, grey  
seams, without logo

**NEW**



REF. SHH0NS709CN  
Colours. Black-grey, red  
seams, without logo

# Honda

## INTEGRA

REF.SHH01720C

Model and year  
INTEGRA 700(2012)



REF.SHH01720C  
Colours.Black, white seams

# Piaggio

## MP3

REF.SHV0M2320

Model and year  
MP3 RL (07-12)  
MP3 RST 125-250-100 (09-12)  
MP3 LT 250-400 (09-13)  
MP3 500 SPORT/BUSINESS (11-13)



**NEW**



REF.SHV0M2329  
Colours.Black-grey,  
grey-red seams



REF.SHV0M2320  
Colours.Black-white,  
grey-blue seams



REF.SHV0M2110  
Colours.Black, red seams



REF.SHV0M2120  
Colours.Black, grey seams



REF.SHV0M2329H  
Colours. HEATING: Black-  
grey, grey-redseams





# SHAD zulupack®

100% Waterproof  
adventure bags

Moto  
Fixation  
4 STRAPS  
INCLUDED

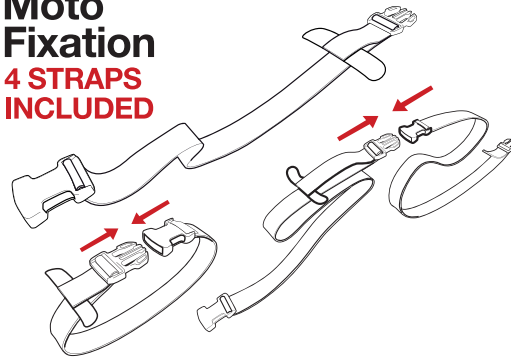

Velcro straps

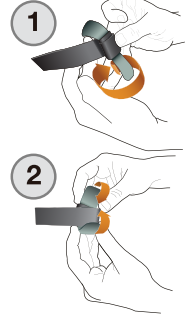

NEW  
PVC Double structure



Light  
Materials



Flexible



Abrasion  
Resistant



Tear  
Resistant



Seamless



High  
Frequency  
Welding  
Technology



EVA



Light  
Material



Padded

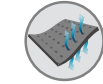

Breathable



Waterproof in only 3 steps



Versatile and functional  
Adventure-proof in any climate condition  
Easy to adapt to motorcycles and ATV

# 100% Waterproof Bags

Waterproof  
Small Bag

# SW05

REF. WOSB05

13 cm  
20 cm  
15 cm



Shock-proof inner removable compartment for cameras or electronic devices.

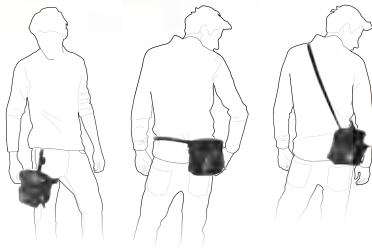

Characteristics Page 13



## Waterproof Rear Tube

# SW40

REF. WOSB40

62 cm  
20 cm

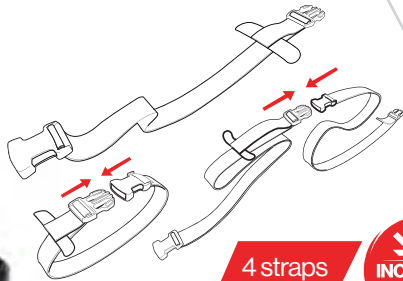

4 straps



Ideal for use on side cases or as a rear motorcycle bag.



Characteristics Page 13





# Waterproof Rear Backpack

# SW25

REF. WOSB25

46 cm  
22 cm  
13 cm

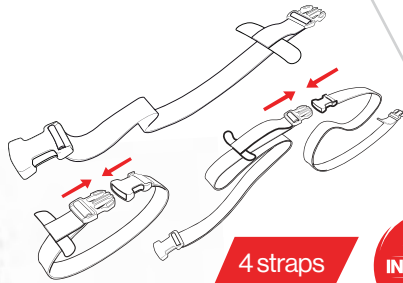

4 straps



Padded shoulder straps and back with EVA foam.  
Foamed back protector.



Characteristics Page 13



# Waterproof Rear Backpack

# SW35

REF. WOSB35

42 cm  
26 cm  
17 cm

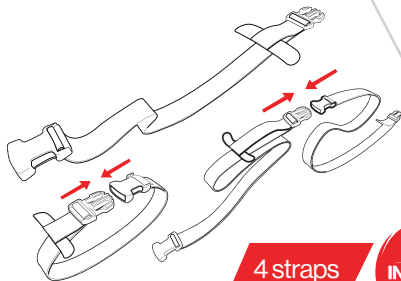

4 straps



Padded shoulder straps and back with EVA foam.  
Foamed back protector.



Characteristics Page 13



# 100% Waterproof Bags

## Waterproof Magnet Tankbag + Backpack

# SW22

REF. WOSB22M

17 cm  
42 cm  
26 cm



Helmet / accesories carrier



Inner bag included to guarantee 100% waterproofness.



From backpack to MAGNET base tank in few steps.



Characteristics Page 13

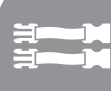

## Waterproof Laptop Bag

# SW18

REF. WOSB18

22 cm  
40 cm  
40 cm

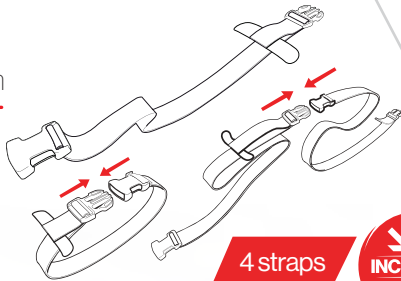

4 straps



Shock - proof inner compartment, foamed and removable, special for laptops or electronic devices.

Use it as a rear motorcycle bag.



Characteristics Page 13

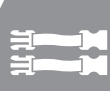

# Waterproof Rear Duffle Bag

# SW38

REF. WOSB38

55 cm  
Ø 30 cm

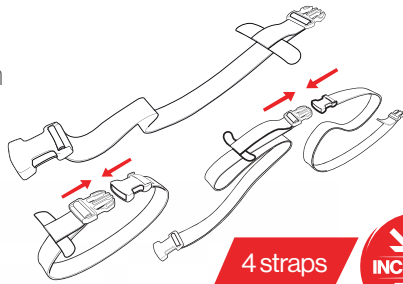

4 straps



Characteristics Page 13



# Waterproof Rear Bag

# SW28

REF. WOSB28

28 cm  
36 cm  
28 cm

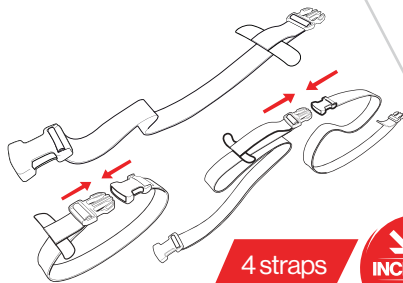

4 straps



Foam dividers

Removable inside foamed compartment for laptop or camera protection.



Tripod Holder Strap.



Characteristics Page 13



# 100% Waterproof Bags

## Waterproof Saddle Bags

# SW42

REF. WOSB42

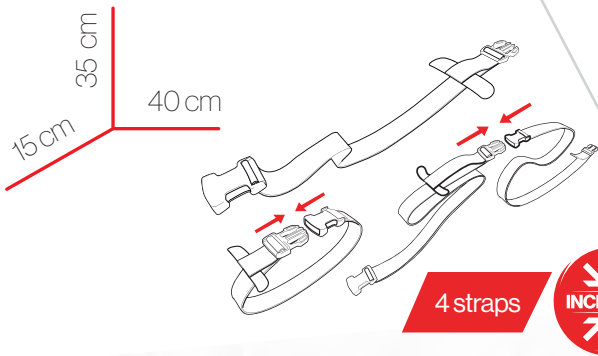

Make them rigid with the included plastic piece



Characteristics Page 13



## Waterproof Travel Bag

# SW55

REF. WOSB55

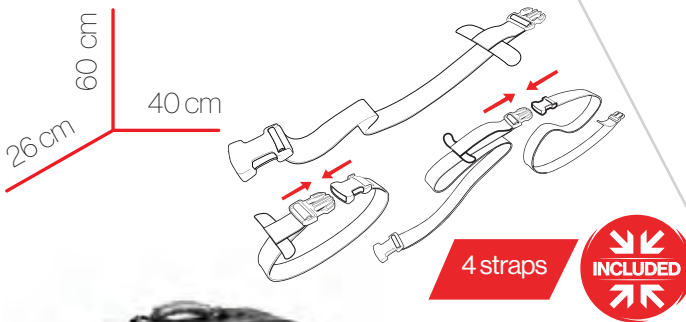

Foamed shoulder belt. Retractable shoulder strap. Comfort handles: 2 front + 2 side

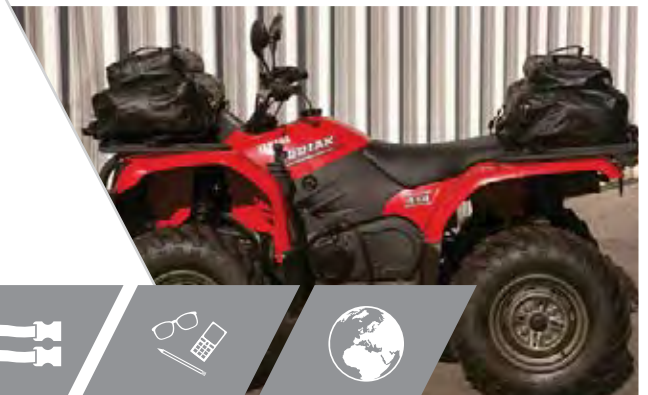

Characteristics Page 13



# Waterproof Big Travel Bag

# SW90

REF. WOSB90

35 cm  
70 cm  
35 cm

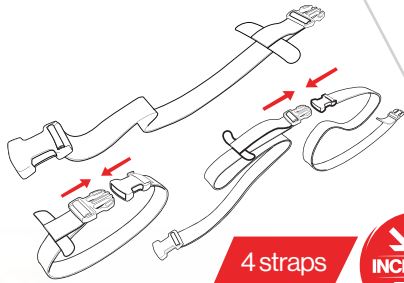

4 straps



Zipped pocket to store all the wet stuff



AIR



Waterproof valve to get the air out



Characteristics Page 13



# Waterproof Huge Travel Bag

# SW138

REF. WOSB138

35 cm  
40 cm  
85 cm

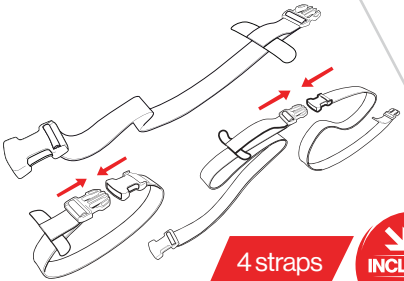

4 straps



Waterproof valve to get the air out



Characteristics Page 13







# Soft bags

79

# SOFT BAGS

**NEW** Gear Bag  
Special for Pilots

# SB 110

REF. X0SB110

42 cm  
45 cm  
82 cm

Big main compartment

Retractable  
Handle

Easy to carry TROLLEY

Helmets pocket  
in a velvet  
style fabric

Shoes pocket  
in PE



Bottom pocket in PE  
for riders leather suits

Padded body to protect the goods

Characteristics Page 13



Rear Bag

# SB 70

REF. X0SB70

Greatest Capacity

Nr. 1  
in MOTORRADFAHRER

31 cm  
30 cm  
53 cm



Velcro pockets

Characteristics Page 13





Saddle Bag

# SB50

REF.X0SB50

29 cm  
47 cm  
20 cm

2 Side Bags

Raincover



External pocket with zipper

Accessory Heat protector

REF.X1SB97

Characteristics Page 13



Sport Side Bag

# SB44

REF.X0SB44

29 cm  
47 cm  
20 cm

Main compartment

Water bottle pocket

Raincover



External pocket with zipper

2 Side Bags

Characteristics Page 13



# SOFT BAGS

Saddle Bag

# SB 60

REF. X0SB60

14 cm  
29 cm  
50 cm

2 Side Bags



External pocket with zipper

Accessory  
Heat protector

REF. X1SB97



Raincover



Characteristics Page 13



Trolley transport system

# Big Tank Bag **SB35**

REF. X0SB35

Super expandable



Touch screen



Net pocket



Convertible in Back Pack

**Base Tank**  
REF. X1SB90



Characteristics Page 13



# Tank Bag **SB25**

REF. X0SB25



Touch screen



External pocket with zipper

**Accessory Magnets**  
REF. X1SB11



**Accessory 2 extra suction cups**  
REF. X1SB10



**2 Systems INCLUDED**

- 3 fixation straps
- 2 suction cups + 1 strap



Characteristics Page 13



# SOFT BAGS

Enduro Bag

# SB23

REF. X0SB23

29 cm  
17 cm  
30 cm

GPS protector pocket

Internal pocket with zipper

Convertible in Back Pack

Base Tank

REF. X1SB90



Characteristics Page 13



Tank Bag

# SB22

REF. X0SB22

24 cm  
21 cm  
40 cm

Touch screen

Accessory Magnets

REF. X1SB11

Accessory 2 extra suction cups

REF. X1SB10

**2 Systems INCLUDED**

- 3 fixation straps
- 2 suction cups + 1 strap

Characteristics Page 13



optional

GPS Tank Bag

# SB15

REF. X0SB15

33 cm  
19 cm  
17 cm



External pocket with zipper

GPS Pocket



**Accessory Magnets**

REF. X1SB11



**Accessory 2 extra suction cups**

REF. X1SB10



**2 Systems INCLUDED**

- 3 fixation straps
- 2 suction cups + 1 strap

Characteristics Page 13



Back Pack

# SB90

REF. X0SB90

\*Available until stock lasts

44 cm  
30 cm  
12 cm

**Light weight**

External pockets with zipper



**Urban Style**



Characteristics Page 13



# SOFT BAGS

Back Pack

# SB85

REF. XOSB85

50 cm  
33 cm  
20 cm

Light weight

External net pocket

Inner compartment

Laptop protection

Characteristics Page 13



Back Pack

# SB80

REF. XOSB80

50 cm  
30 cm  
8 cm

Rigid Protection.  
Special for Electric devices.

Multiple compartments

Laptop protection

Characteristics Page 13



Ergonomic Shape



Tank Pouch Magnet  
Tank Pouch Suction

# SB 12

REF. X0SB12M  
REF. X0SB12S

30 cm  
6 cm  
17 cm

Mobile  
Protector

Multiple  
compartments



Characteristics Page 13



## Tank Pouch

# SB 11

REF. X0SB11

16 cm  
9 cm  
23 cm

Small and functional

Inner  
Pockets

Zipper compartments

Velcro compartments



Characteristics Page 13



# SOFT BAGS

Holster Bag

# SB05

REF. X0SB05

7 cm  
15 cm  
22 cm



External pocket with zipper

Characteristics Page 13



Multiple compartments



Belt strap  
Included

Holster Bag

# SB04

REF. X0SB04

2 cm  
12 cm  
24 cm



Net pocket

Internal compartments

Characteristics Page 13



Belt strap  
Included



Rider Pouch

# SB03

REF.X0SB03

5 cm  
14 cm  
22 cm

External pocket with zipper



Net compartments



Characteristics Page 13



Waist Bag

# SBT5

REF.X0SBT5

9 cm  
16 cm  
23 cm

Small and functional

Velcro compartments

External pockets with zipper



Zipper compartments



Characteristics Page 13



# SOFT BAGS

Toll Pass Pouch

# SBT4

REF. XOSBT4



Characteristics Page 13



Toll Pass/ Teletac

Tool Bag

# SBT2

REF. XOSBT2



Elastic holders



Net pocket with zipper

Characteristics Page 13



Tool Bag

# SBT1

REF. XOSBT1



Buckle strap



Tools pocket

Keep your tools organized

Scooter Bag

# SC30

REF. X0SC30

26 cm  
40 cm  
30 cm



Characteristics Page 13



Scooter Bag

# SC20

REF. X0SC20

28 cm  
32 cm  
30 cm

External pockets with zipper



Characteristics Page 13

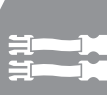

# GPS / SMARTPHONES BRACKETS

## NEW GPS holder Mirror Bracket



8,5 cm  
12,5 cm  
REF. X0SG50M  
3,5"

9 cm  
14 cm  
REF. X0SG40M  
4,3"



Quick Assembly

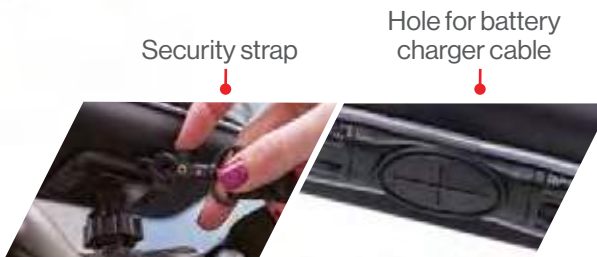

Characteristics Page 13



## NEW GPS holder Handlebar Bracket

# SG 50H-40H

REF. X0SG50H

REF. X0SG40H



8,5 cm  
12,5 cm  
3,5"

9 cm  
14 cm  
4,3"



Quick Assembly

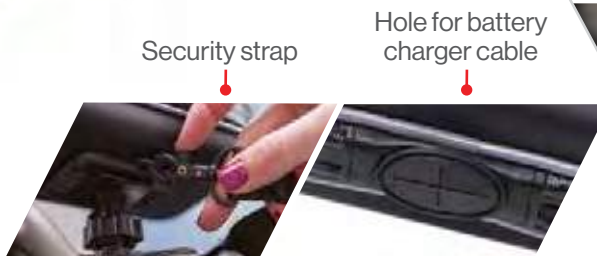

Characteristics Page 13



**NEW** Smartphone holder  
Mirror Bracket

**SG 60M-20M-10M**



16 cm	REF.X0SG60M	12 cm	REF.X0SG20M	14 cm	REF.X0SG10M
9 cm	▲5,5"▼	7 cm	▲3,8"▼	8 cm	▲4,3"▼



Characteristics Page 13



**NEW** Smartphone holder  
Handlebar Bracket

**SG 60H-20H-10H**



16 cm	REF.X0SG60H	12 cm	REF.X0SG20H	14 cm	REF.X0SG10H
9 cm	▲5,5"▼	7 cm	▲3,8"▼	8 cm	▲4,3"▼



Characteristics Page 13







# ATV cases

95

# ATV CASES

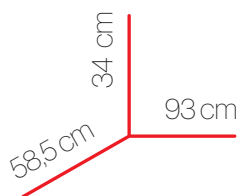

Safety lock & Reflector  
 Cierre de alta seguridad & Catadióptrico  
 Fermeture de sécurité & Réfléchissant  
 Sicherverschlussystem & Reflektor  
 Chiusura di alta securitá & Catarifrangente  
 Fachadura de alta segurança & Refletor



Fitting  
 Fijación  
 Fixation  
 Befestigung  
 Atacco  
 Fixação



Backrest  
 Respaldo  
 Dossieret  
 Rückenpolster  
 Schienale  
 Encosto



Characteristics Page 12

110  
 kg



x3





# ATV110

REF.D0Q100



Maximum load



# ATV CASES

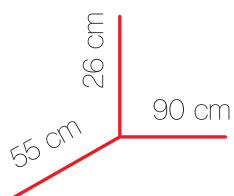

**INCLUDED**

Fitting  
Fijación  
Fixation  
Befestigung  
Atacco  
Fixação



**INCLUDED**

Backrest  
Respaldo  
Dossieret  
Rückenpolster  
Schienale  
Encosto



Reflector  
Catadióptrico  
Réflechissant  
Reflektor  
Catarifrangente  
Refletor

**INCLUDED**



High safety lock  
Cierre de alta seguridad  
Fermeture de sécurité  
Sicherverschlussystem  
Chiusura di alta securitá  
Fachadura de alta segurança

**INCLUDED**

Characteristics Page 13

kg 15



# ATV 80

REF. S0Q800



# ATV CASES

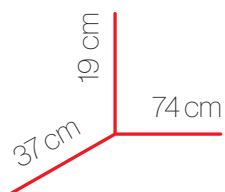

Locking  
Cierre  
Fermeture  
Verschluss  
Chiusura  
Fecho



Fitting  
Fijación  
Fixation  
Befestigung  
Atacco  
Fixação



Reinforced finishes  
Acabados reforzados  
Finitions renforcées  
Verstärkte ausführung  
Rinforzi nelle finiture  
Acabamentos  
Reforçados

Characteristics Page 12

kg 5



# ATV 40

REF.D0Q200



# ATV CASES

# ATV BAG100

REF.X0ATVS100

20 cm  
47 cm  
87 cm



Cool bag



Characteristics Page 13



# NEW ATV BAG55

REF.X0ATVS55

27 cm  
27 cm  
70 cm



Inner pocket



Reflector



Inner divider



Inner Compartment in PE

Characteristics Page 12



# SPARE PARTS

## SH50



Ref.D1B40BOR

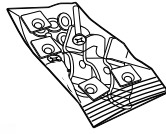

Ref.D1B48PAR

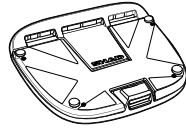

Ref.D1B1TIR

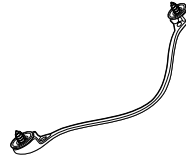

Ref.DORI70

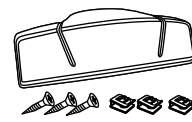

Ref.D1B50CGR

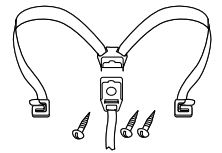

Ref.200583R

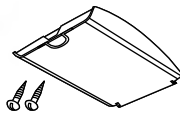

Ref.201722R

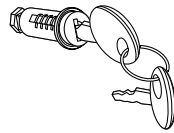

Ref.200799R



Ref.D1B50CAR

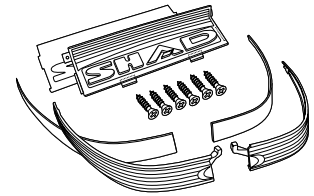

Ref.200784R

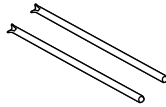

Ref.D1B50MAR

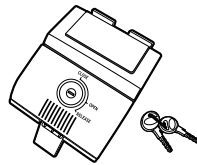

Ref.400316R



Ref.D1B50EMR

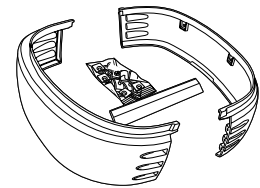

## SH49



Ref.D1B40BOR

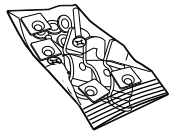

Ref.D1B48PAR

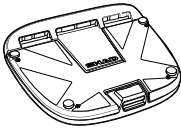

Ref.D1B1TIR

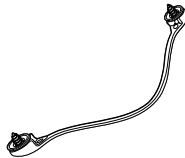

Ref.201722R

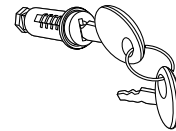

Ref.D1B50CGR

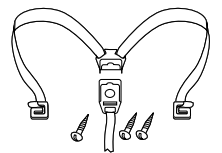

Ref.200784R

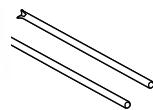

Ref.D1B49MAR



Ref.200799R



Ref.D1B49EMR

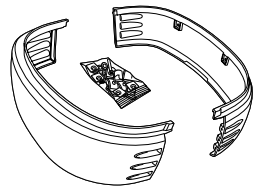

Ref.D1B49CAR

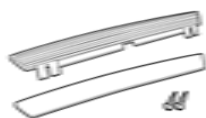

Ref.D1B49ETR

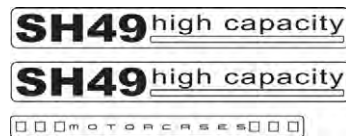

Ref.D1B491CLR





# SH48

New Titanium Dark Grey



Ref.D1B48PAR

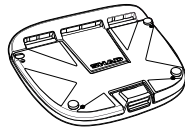

Ref.D1B40BOR

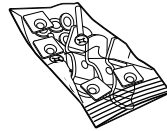

Ref.D1B1TIR

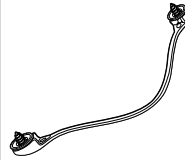

Ref.D1B48CGR

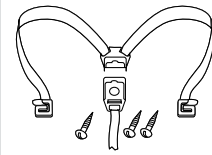

Ref.200784R

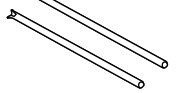

Ref.200799R



Ref.201896R

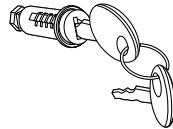

Ref.400316/1R



Ref.D1B48CAR

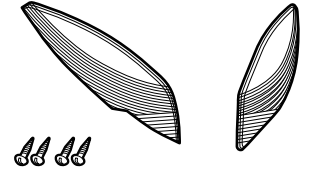

New Titanium



Ref.D1B482MAR



Ref.D1B482ETR



Dark Grey



Ref.D1B481MAR



Ref.D1B481ETR



Ref.D1B482EMR

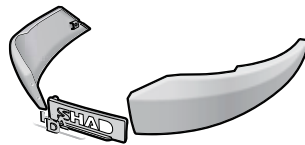

Ref.D1B481EMR

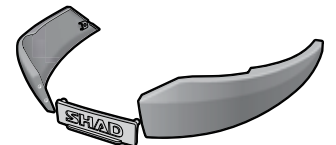

# SH46



Ref.201121R

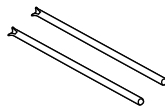

Ref.D1B40BOR

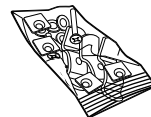

Ref.201722R

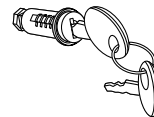

Ref.D1B461ETR

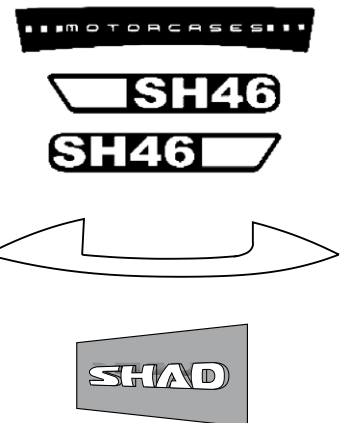

Ref.400253R

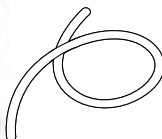

Ref.D1B40PAR



Ref.D1B2TIR

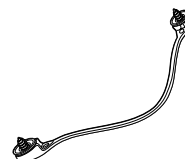

Ref.D1B461CAR

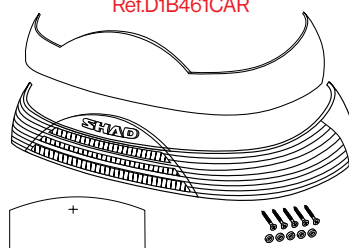

Ref.D1B4CGR

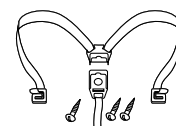



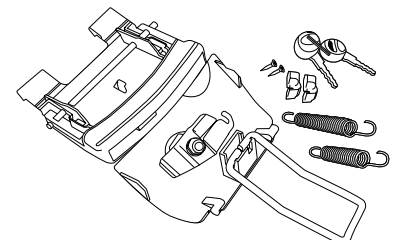





Ref.D1B46MAR

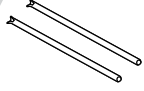

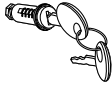
# SPARE PARTS

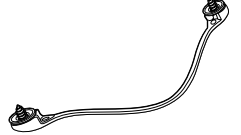
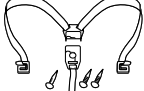

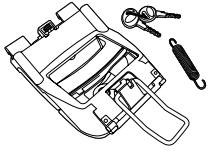

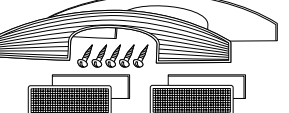



## SH45

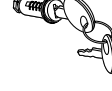

Ref.201121R 	Ref.D1B40BOR 	Ref.201722R 	Ref.D1B45ETR (RED) 	Ref.D1B451ETR (WHITE) 	Ref.D1B1TIR 
Ref.D1B45CGR 	Ref.400271R 	Ref.D1B45MAR 	Ref.D1B40PAR 	Ref.D1B45CAR (RED) / Ref.D1B451CAR (WHITE) 	



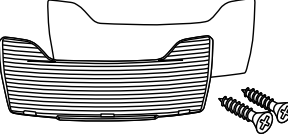
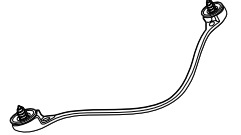

## SH40 Cargo



Ref.201121R 	Ref.D1B40BOR 	Ref.201722R 	Ref.D1B40ETR (RED) 	Ref.D1B401ETR (WHITE) 	Ref.D1B40PAR 	Ref.D1B45MAR 
Ref.D1B40PTR 	Ref.400271R 	Ref.D1B40CAR (RED) / Ref.D1B401CAR (WHITE) 	Ref.D1B1TIR 			

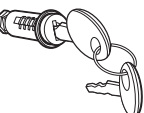
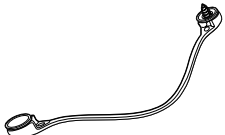
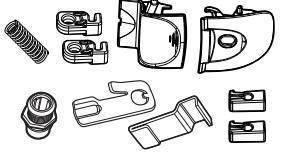
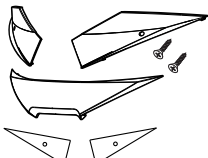
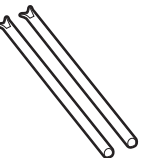

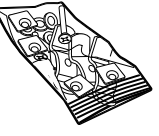

## SH39



Ref.D1B39ETR <b>SH39 SH39 SHAD</b>	Ref.201722R 	Ref.D1B1TIR 	Ref.D1B391MAR 			
Ref.D1B39CAR 	Ref.201121R 	Ref.D1B40PAR 	Ref.D1B40BOR 	Ref.200723R 		

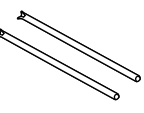

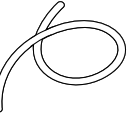

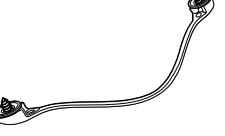
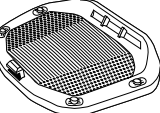
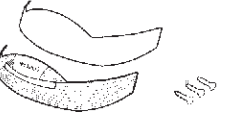
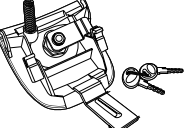

## SH37

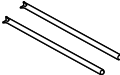

Ref.201121R 	Ref.D1B37BOR 	Ref.201722R 	Ref.400271R 	Ref.D1B371ETR 	Ref.D1B1TIR 
Ref.D1B37PAR 	Ref.D1B371CAPR 		Ref.D1B37MAR 		





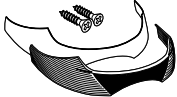
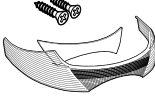
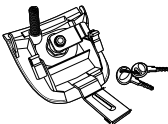



# SH33

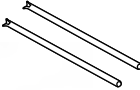

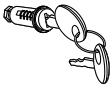
Ref.201121R 	Ref.D1BABOR 	Ref.201722R 	Ref.D1B33ETR (RED) 	Ref.D1B331ETR (WHITE) 	Ref.D1B1TIR 
Ref.D1B29PAR 	Ref.D1B33CAR 	Ref.D1B331CAR (WHITE) 	Ref.D1B33MAR 		



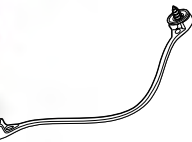
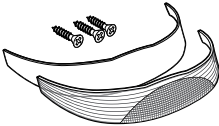

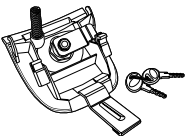
# SH29

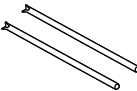

Ref.201121R 	Ref.D1BABOR 	Ref.201722R 	Ref.D1B29ETR (RED) 	Ref.D1B291ETR (WHITE) 	Ref.D1B29PAR 
Ref.D1B1TIR 	Ref.D1B29CAR (RED) 	Ref.D1B291CAR (WHITE) 	Ref.D1B29MAR 		

# SH26

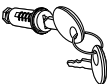
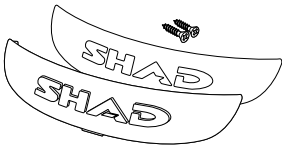

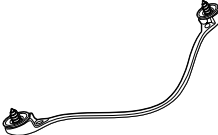
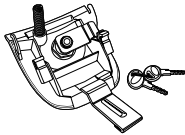
Ref.201121R 	Ref.D1BABOR 	Ref.201722R 	Ref.D1B26CAR (RED) 	Ref.D1B261CAR (WHITE) 
Ref.D1B29PAR 	Ref.D1B1TIR 	Ref.D1B29MAR 		

# SPARE PARTS

## SH43 Side Case



Ref.D1B43CAR  
(RED)  
Ref.D1B431CAR  
(WHITE)

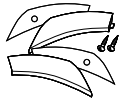

Ref.201121R

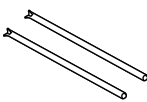

Ref.D1B43ETR  
(RED)



Ref.D1B431ETR  
(WHITE)



Ref.D1B4CGR

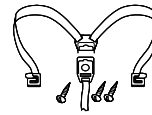

Ref.D1B43MAR

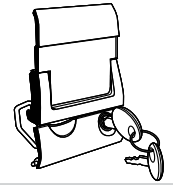

Ref.D1B4TIR



Ref.400269/1R



Ref.200062R

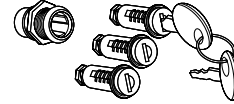

Ref.200035R



## SH42 Side Case



Ref.201121R

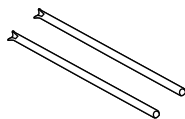

Ref.D1B40BOR

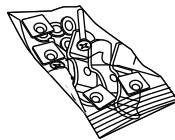

Ref.200137R

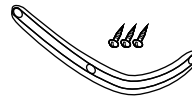

Ref.200062R

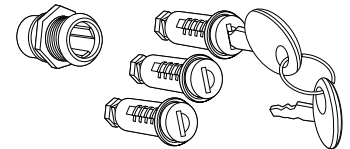

Ref.D1B40PAR



Ref.D1B3TIR

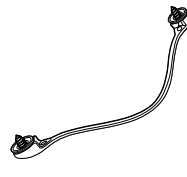

Ref.400253R

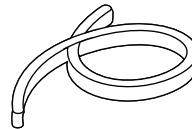

Ref.D1BNMAR

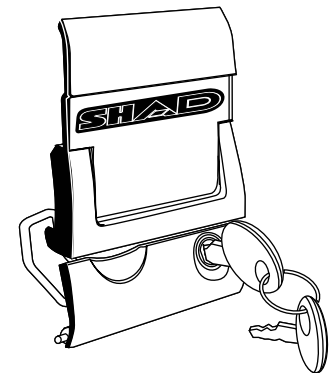

Ref.D1BNETR

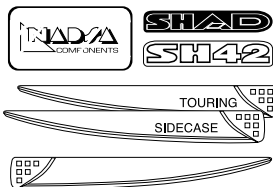

Ref.D1B4CGR

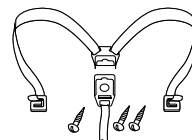

## SH36 Side Case



Ref.200784R



Ref.D1B36CGR

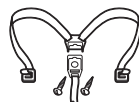

Ref.D1B361G0R



Ref.200062R



Ref.400269/1R



Ref.D1B361MAR

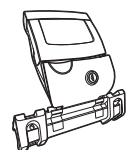

Ref.D1B5TIR



Ref.D1B36CAR (Red)



Ref.D1B361CAR (White)

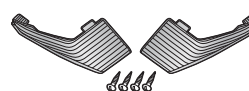

Ref.D1B3613PR



Ref.501424R

SHAD

# ATV 110



Ref.200537R

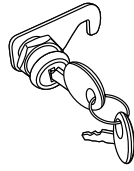

Ref.D1BQ8CAR

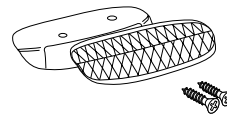

Ref.DORI50



Ref.D1Q11ETR



Ref.S1Q8B0R

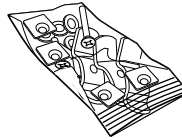

Ref.D1TV80R

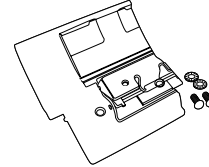

Ref.201528R

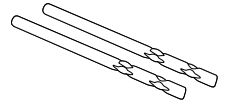

# ATV 80



Ref.200452R

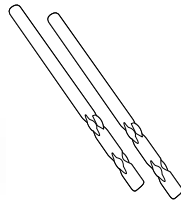

Ref.S1Q8B0R

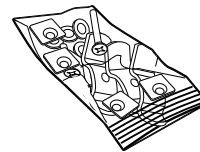

Ref.200451R

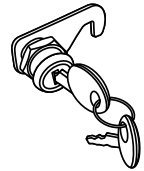

Ref.500545R



Ref.D1TV80R

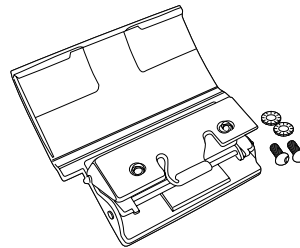

Ref.D1BQ8CAR

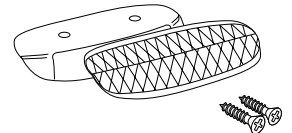

Ref.DORI50

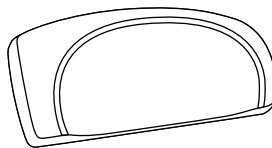

Ref.200035R



# ATV 40



Ref.201481R

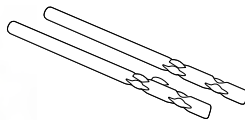

Ref.S1Q8B0R

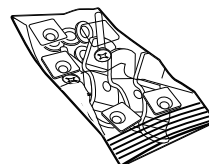

Ref.200537R

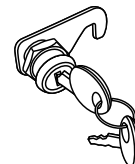

Ref.500545R



# DISPLAY

REF. 1D0EX03 + 2 D0EX02 + 1D0EX10

## 9 Top Cases



## Seat Display



REF. D0EX13

## 1 Top case + 2 Side cases



## SH36 display



REF. D0EX02

### 3 Top Cases



REF. D0EX10

### Big top cases SH50-SH49-SH48



### Shad corner



# SHAD

## Línea para **ESPAÑA**

Teléfono: +34 935 795 870

## Ligne pour la **FRANCE**

Téléphone: +34 935 795 868

## **SHAD**

Octave Lecante, 2-6  
Pol. Ind. Can Magarola  
08100 Mollet del Vallès · Barcelona · Spain  
Tel.: +34 935 795 860  
Fax: +34 935 796 945

## Shad **ASIA**

Room 11P14,16No.2299 YAN AN Road (West)  
Changning District · Shanghai · China  
Tel.: +86 21 62365730  
Fax: +86 21 62365730

NADSL reserves the right to amend its model's specifications without prior notice.

NADSL se reserva el derecho de modificar las especificaciones de sus modelos sin previo aviso.

NADSL se réserve le droit de modifier ses modèles sans préavis.

NADSL behält sich das Recht vor, die Merkmale seiner Modelle ohne Ankündigung zu ändern.

la NADSL si riserva il diritto di modificare i propri modelli e le loro applicazioni senza preavviso.

NADSL reserva-se o direito de modificar as especificações dos seus modelos sem prévio aviso.

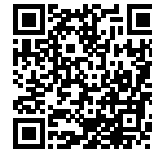

[www.shad.es](http://www.shad.es)

[info@shad.es](mailto:info@shad.es)

