

2017

motorcycle
& scooter

RMS
YOUR BEST PARTNER

The background of the entire page is a repeating pattern of various icons related to motorcycles and automotive maintenance. These icons include motorcycles, gears, wrenches, screwdrivers, batteries, pistons, and other mechanical components, all rendered in a light gray color.

RMS
YOUR BEST PARTNER



IL MIGLIOR PARTNER PER LE MIGLIORI PRESTAZIONI

RMS è un'azienda leader all'interno del panorama europeo per quanto riguarda la distribuzione di ricambi ed accessori per bici e scooter, che propone un'offerta completa rivolta a produttori e rivenditori di entrambi i settori.

Si avvale di partnership consolidate con i maggiori produttori mondiali, che garantiscono un ventaglio di prodotti all'avanguardia in un settore estremamente competitivo ed in continua evoluzione.

La soddisfazione del cliente rappresenta da sempre una delle principali priorità: nel perseguirla RMS utilizza sistemi logistici innovativi e tecnologie avanzate, affiancandole ai classici strumenti di divulgazione diretta, come i cataloghi in versione cartacea e digitale. Customer Satisfaction significa inoltre una presenza capillare sul territorio, grazie ad una rete di agenti in contatto diretto sia con il cliente che con la sede centrale, in grado per questo di rispondere prontamente a qualsiasi evenienza, di snellire le procedure e di completare in tempi brevi le pratiche di raccolta ed evasione degli ordini.

Tutti i clienti RMS hanno la possibilità di accedere ad un'area riservata su www.rms.it. Uno strumento completamente dedicato alle loro esigenze, tramite cui gestire e monitorare gli ordini, visualizzare le disponibilità, ricevere ed elaborare statistiche ed informazioni e raccogliere i relativi documenti in assoluta sicurezza.

3.000+
CLIENTI

LO SAPEVI CHE...

...la nostra area B2B è accessibile

24/7

- ▲ Home page con novità, promozioni e news;
- ▲ Ricerca prodotti facile e veloce.
Hai solo il riferimento del fornitore? Puoi utilizzare il codice originale per trovare il prodotto che ti serve;
- ▲ Disponibilità dei prodotti in tempo reale;
- ▲ Tracciabilità degli ordini;
- ▲ Fatture e packing-list scaricabili;
- ▲ Statistiche consultabili;
- ▲ Listini dedicati e cataloghi scaricabili;

QUESTO E MOLTO ALTRO!

KENDA



ROLF



DAYCO

UFI



BANDO



Koyo



NYPSO



NTN



24.000^{MQ}

▲ SUPERFICIE TOTALE

14.000^{MQ}

▲ DI CUI
INTERAMENTE COPERTI

500^{MQ}

▲ UFFICI

40 AGENTI

▲ SUL TERRITORIO
NAZIONALE
ED ESTERO

SISTEMA MODULA

▲ ARMADIO VERTICALE
IN GRADO DI GESTIRE 30 ORDINI
CONTEMPORANEAMENTE



OLTRE 400

▲ CONTAINER
MOVIMENTATI
ANNUALMENTE

18.000

▲ POSTI PALLETS

OLTRE
10.000

▲ REFERENZE A MAGAZZINO

MAGAZZINI
AUTOMATIZZATI
CON SISTEMA

RFID



A

Alberi Motore 20
 Alberi Ruota Posteriore 323
 Ammortizzatori FORSA 542
 Astucci a Rulli 102
 Attrezzi officina - BIKESERVICE 1006

B

Batterie - BS 851
 Batterie ELEKTRA 857
 Batterie Litio LI-ON 846
 Bobine - Centraline AT 926
 Bobine Accensione BERU 933
 Boccole Messa in Moto 307
 Bulloni 795

C

Calandre 819
 Calotte Sterzo 779
 Campana Frizione 246
 Candele CHAMPION 860
 Capicorda Morsetti 441
 Cappucci Candele 867
 Carica batterie - BS 855
 Carica batterie - Elektra 858
 Carrozzeria Particolari 810
 Catene Di Distribuzione KMC 47
 Catene Pompa Olio 56
 Catene Trasmissione KMC- AMC 330
 Cavalletti Centrali 514
 Cavalletti Lateralì 527
 Cavi - Contachilometri 407
 Cavi Freno 418
 Cavi Gas 422
 Cavi Moto 444
 Cavi Starter 432
 Cavi VESPA 436
 Centraline Elettroniche - CDI 920
 Cerchi 774
 Chiavi Candela 1015
 Cilindri 27
 Cilindri Freno 771
 Cilindri Racing 39
 Cilindri Serratura - RMS - ZADI 979
 Cinghie Ape - Ciclomotore 235
 Cinghie Fissaggio per Trasporto 1018
 Cinghie Miscelatore - Distribuzione 235
 Cinghie Trasmissione DAYCO - RMS 216
 Claxon 904
 Collettori Aspirazione - Scarico 117
 Comandi Gas - DOMINO 388
 Comandi Portaleva - DOMINO 385
 Condensatori 986
 Connettori Elettrici 983
 Contachilometri Vespa 808
 Contatti 987
 Contenitori Rulli Variatore 274
 Coperture - Camere KENDA 1022
 Coprimanubri 817
 Copriventola 326
 Crocere Cambio 320
 Cuffie Testa Cilindro 326
 Cuscinetti a Sfere 98

D-E

Dadi 790
 Devio Luci 899
 Dischi Freno 754
 Estrattori Volano 1014

F

Fanali anteriori 880
 Fanali posteriori 884
 Fasce Elastiche 43
 Filtri Aria - RMS - UFI 124
 Filtri Aria - Tabella Applicazioni 147
 Filtri Aria CHAMPION 161
 Filtri Aria Quad 146
 Filtri Aria Racing 122
 Filtri Carburante 202
 Filtri Olio CHAMPION 206
 Filtri Olio NYPSO 178
 Filtri Olio UFI 188
 Forcelle 775
 Freccie Moto Complete 869
 Frizioni multidisco 317

G

Gabbie a Rulli 102
 Fusibili 917
 Gabbiette Sterzo 789
 Ganasce Freno 615
 Giranti Frizione 236
 Giunti Catene - Vespa 331
 Guarnizioni 68

I-J

Impianti elettrici 982
 Ingranaggi Avviamento Kit 315
 Intermittenze Freccie 912
 Interruttore termico 915
 Interruttori elettrici Moto - DOMINO 392
 Interruttori Stop 910

K

Kit Conversione Luci a Led 894
 Kit Gommini Telaio Vespa 810
 Kit Pronto Soccorso 1017
 Kit Pulegge Motrici 273
 Kit Revisione Albero Motore 103
 Kit Revisione Pompa Acqua 88
 Kit Tagliando Scooter 302

L

Lampadine 888
 Lana di Roccia 214
 Lenti Freccie 875
 Leve Freno - Figurato 342
 Leve Freno - Tabella Applicazioni 361
 Lucchetti - Catene 1003

M

Manicotti Aspirazione 117
 Manopole - DOMINO 396
 Manopole RMS 402
 Marmitte 213
 Misurini Centilitrati 804
 Molle Messa in Moto 308
 Morsetti 441
 Motorini Avviamento 947

O-P-Q

Olio Motore - PETRONAS LINX 992
 Pacchi Lamellari 116
 Parafanghi 820
 Paraoli - Per Misura 114
 Paraoli Sets 107
 Paraoli Valvole 57
 Particolari gomma motore 324
 Pastiglie Freno Applicazioni RMS - SINTER 618

Pastiglie Freno Figurato RMS - SINTER 579
 Pattini Tendicatena Distribuzione 66
 Pedali 827
 Pedivelles Avviamento 309
 Pick Up 968
 Pignoni Messa in Moto 305
 Pistoni 43
 Pompe Benzina 805
 Pompe Freno 772
 Portapacchi Vespa 829
 Portatarga 829
 Preselettori Cambio 321
 Prigionieri 796
 Prodotti Chimici Moto PETRONAS 991
 Prodotti Chimici Officina AREXONS 994
 Profili Vespa 825
 Prolunghe Ammortizzatori Scooter 576
 Pulsanti Claxon 899
 Quadretti Avviamento - RMS - ZADI 970

R

Regolatori di Tensione 938
 Relè Avviamento 924
 Relè Freccie 912
 Relè Ventola 96
 Resistenze 914
 Resistenze Freccie 870
 Rinvii Contachilometri 443
 Riparazione Tubeless 1016
 Riparazione Tubeless AIRMAN 1019
 Rondelle 790
 Rubinetti - Pompe Benzina 801
 Rulli Puleggia Motrice 276
 Ruote Libere Avviamento 311

S

Semipulegge Condotte Fisse 268
 Semipulegge Condotte Scorrevoli 271
 Semipulegge Motrici Fisse 257
 Semipulegge Motrici Mobili 261
 Sensori 915
 Settori Messa in Moto 304
 Soffietti 117
 Sonde Lambda 916
 Specchi Retrovisori MOTO 487
 Specchi Retrovisori SCOOTER 454
 Statori 957
 Strisce Pedana Vespa 826
 Supporti elastici 324

T-V

Tamburi Freno 773
 Tappetini in Gomma Vespa 811
 Tappi Benzina, olio motore, olio freni 807
 Targhette 832
 Tasselli Traino 275
 Teli Copri Moto 1018
 Termostati 96
 Teste Motore 42
 Trasmissione Ape Giunti 322
 Trasmissioni APE - Cavi 446
 Trasmissioni Primarie 317
 Trasmissioni VESPA - Cavi 436
 Tubi Benzina - Olio 804
 Tubi comando cambio / gas Vespa 445
 Ventole Pulegge Motrici 275
 Vernice Spray WRAPPER 1000
 Viteria 790
 Volani 965



MOTORE

Alberi Motore	20
Boccole Messa in Moto	307
Catene Di Distribuzione KMC	47
Catene Pompa Olio	56
Cilindri	27
Cilindri Racing	39
Cinghie Ape - Ciclomotore	235
Cinghie Miscelatore - Distribuzione	235
Collettori Aspirazione - Scarico	117
Copriventola	326
Crocere Cambio	320
Cuffie Testa Cilindro	326
Fasce Elastiche	43
Filtri Aria - RMS - UFI	124
Filtri Aria - Tabella Applicazioni	147
Filtri Aria CHAMPION	161
Filtri Aria Quad	146
Filtri Aria Racing	122
Filtri Carburante	202
Filtri Olio CHAMPION	206
Filtri Olio NYPSO	178
Filtri Olio UFI	188
Guarnizioni	68
Ingranaggi Avviamento Kit	315
Kit Revisione Albero Motore	103
Kit Revisione Pompa Acqua	88
Lana di Roccia	214
Manicotti Aspirazione	117
Marmitte	213
Molle Messa in Moto	308
Pacchi Lamellari	116
Paraoli - Per Misura	114
Paraoli Sets	107
Paraoli Valvole	57
Particolari gomma motore	324
Pattini Tendicatena Distribuzione	66
Pedivelle Avviamento	309
Pignoni Messa in Moto	305
Pistoni	43
Ruote Libere Avviamento	311
Settori Messa in Moto	304
Soffietti	117
Supporti elastici	324
Teste Motore	42



TRASMISSIONE

Alberi Ruota Posteriore	323
Campane Frizione	246
Catene Trasmissione KMC- AMC	330
Cavi Moto	444
Cinghie Trasmissione DAYCO - RMS	216
Contentitori Rulli Variatore	274
Frizioni multidisco	317
Giranti Frizione	236
Giunti Catene	331
Kit Pulegge Motrici	273
Kit Tagliando Scooter	302
Preselettori Cambio	321
Rulli Puleggia Motrice	276
Semipulegge Condotte Fisse	268
Semipulegge Condotte Scorrevoli	271
Semipulegge Motrici Fisse	257
Semipulegge Motrici Mobili	261
Tasselli Traino	275
Trasmissione Ape Giunti	322
Trasmissioni Primarie	317
Ventole Pulegge Motrici	275



TELAIO

Ammortizzatori FORSA	542
Calandre	819
Calotte Sterzo	779
Capicorda Morsetti	441
Cavalletti Centrali	514
Cavalletti Lateralali	527
Cavi - Contachilometri	407
Cavi Freno	418
Cavi Gas	422
Cavi Starter	432
Cavi VESPA	436
Cerchi	774
Cilindri Freno	771
Comandi Gas - DOMINO	388
Comandi Portaleva - DOMINO	385
Contachilometri Vespa	808
Coperture - Camere KENDA	1022
Coprimanubri	817
Dischi Freno	754
Forcelle	775
Gabbiette Sterzo	789
Ganasce Freno	615
Kit Gommini Telaio Vespa	810
Leve Freno - Figurato	342
Leve Freno - Tabella Applicazioni	361
Manopole - DOMINO	396
Manopole RMS	402
Morsetti	441
Parafanghi	820
Pastiglie Freno Applicazioni RMS - SINTER	618
Pastiglie Freno Figurato RMS - SINTER	579
Pedali	827
Pompe Freno	772
Portapacchi Vespa	829
Portatarga	829
Profili Vespa	825
Prolunghe Ammortizzatori Scooter	576
Rinvii Contachilometri	443
Specchi Retrovisori MOTO	487
Specchi Retrovisori SCOOTER	454
Strisce Pedana Vespa	826
Tamburi Freno	773
Tappettini in Gomma Vespa	811
Trasmissioni APE - Cavi	446
Trasmissioni VESPA - Cavi	436
Tubi comando cambio / gas Vespa	445
Viteria	790



IMPIANTO ELETTRICO

Batterie - BS	851
Batterie ELEKTRA	857
Batterie Litio LI-ON	846
Bobine - Centraline AT	926
Bobine Accensione BERU	933
Candele CHAMPION	860
Cappucci Candele	867
Centraline Elettroniche - CDI	920
Claxon	904
Condensatori	986
Connettori Elettrici	983
Contatti	987
Devio Luci	899
Fanali anteriori	880
Fanali posteriori	884
Frecce Moto Complete	869
Fusibili	917
Impianti elettrici	982
Intermittenze Frecce	912
Interruttore termico	915

Interruttori elettrici Moto - DOMINO	392
Interruttori Stop	910
Kit Conversione Luci a Led	894
Lampadine	888
Motorini Avviamento	947
Pick Up	968
Pulsanti Claxon	899
Quadretti Avviamento - RMS - ZADI	970
Regolatori di Tensione	938
Relè Avviamento	924
Relè Frecce	912
Relè Ventola	96
Resistenze	914
Resistenze Frecce	870
Sensori	915
Sonde Lambda	916
Statori	957
Termostati	96
Volani	965



CARROZZERIA

Carrozzeria Particolari	810
Cilindri Serratura - RMS - ZADI	979
Lenti Frecce	875
Misurini Centilitrati	804
Pompe Benzina	805
Rubinetti - Pompe Benzina	801
Tappi Benzina, olio motore, olio freni	807
Targhette	832
Tubi Benzina - Olio	804

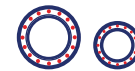

CUSCINETTI

Astucci a Rulli	102
Cuscinetti a Sfere	98
Gabbie a Rulli	102



ATTREZZATURA OFFICINA

Attrezzi officina - BIKESERVICE	1006
Carica batterie - BS	855
Carica batterie - Elektra	858
Chiavi Candela	1015
Cinghie Fissaggio per Trasporto	1018
Estrattori Volano	1014
Kit Pronto Soccorso	1017
Olio Motore - PETRONAS LINX	992
Prodotti Chimici Moto PETRONAS	991
Prodotti Chimici Officina AREXONS	994
Riparazione Tubeless	1016
Riparazione Tubeless AIRMAN	1019
Teli Copri Moto	1018
Vernice Spray WRAPPER	1000



MINUTERIA METALLICA

Bulloni	795
Dadi	790
Prigionieri	796
Rondelle	790



SICUREZZA

Lucchetti - Catene	1003
--------------------	------



A

Air Filters – Applications Table 147
 Air Filters - RMS - UFI 124
 Air Filters CHAMPION 161
 Air Filters Quad 146
 Air Filters Racing Type 122
 Ape Driveshaft Coupling 322

B

Ball Bearings 98
 Batteries - BS 851
 Batteries ELEKTRA 857
 Battery Chargers - BS 855
 Battery Chargers - ELEKTRA 858
 Belts Ape - Moped 235
 Belts DAYCO - RMS 216
 Belts Mixer - Distribution 235
 Blinker Lamps 869
 Blinkers Relays 912
 Body Parts 810
 Bolts 790
 Brake Cables 418
 Brake Cylinders 771
 Brake Discs 754
 Brake Drum 773
 Brake Master Cylinders 772
 Brake Pads Applications Table RMS - SINTER 618
 Brake Pads Drawings RMS - SINTER 579
 Brake Shoes 615
 Bush Starters 307

C

Cables Motorbike 444
 Cables VESPA 436
 Carriers Vespa 829
 CDI 920
 Central Stands 514
 Chains KMC- AMC 330
 Chemical products for Motorcycles PETRONAS 991
 Chemical products for Workshop AREXONS 994
 Choke Cables 432
 Clamps Terminals 441
 Clutch Assy 236
 Clutch Outers 246
 Coils 926
 Condensators 986
 Connecting Links (Chain) 331
 Crankshafts 20
 Crankshafts Revision Kits 103
 Cylinder Head Covers 326
 Cylinder Heads 42
 Cylinder Kits - Original Type 27
 Cylinder Kits - Racing Scooter 50 cc. 39
 Cylinder Locks – RMS – ZADI 979

D-E-F

Drawn Cups 102
 Electric Fuel Pumps 805
 Electrical Connectors 983
 Electrical Devices – DOMINO 392
 Engine rubber parts 324
 Fan Covers 326
 Fan Relay 915
 First Aid Kit 1017
 Fixed Drive Half Pulley 257
 Fixed Driven Half Pulley 268
 Floor Mats Vespa 811
 Flywheel Extractors 1014
 Flywheels 965
 Footrest Stripes Vespa 826
 Forks 775

Frame Rubbers Kit Vespa 810
 Fuel - Oil Hoses 804
 Fuel Filters 202
 Fuel Taps – Pumps 801
 Fuel, Oil and Brake Fluid Caps 807
 Fuses 917

G-H-I

Gasket Sets 68
 Gear Box Selectors 321
 Gear Selectors 320
 Grips – DOMINO 396
 Grips RMS 402
 Handlebar Covers 817
 Hardware 790
 Head Lights 880
 Horn Buttons 899
 Horns 904
 Ignition Coils BERU 933
 Inlet Pipes 117
 Intake bellows 117
 Intermittences 912

K-L-M-N

Key Sets Main Switches - RMS - ZADI 970
 Kick Starters 309
 Lamps 888
 Led Conversion Kit 894
 Lens 875
 Lever Supports – DOMINO 385
 Levers 342
 Levers – Applications Table 361
 Lights Switches 899
 Lithium Batteries LI-ON 846
 Locks 1003
 Motorcycle Covers 1018
 Movable Drive Half Pulley 261
 Movable Driven Half Pulley 271
 Mudguards 820
 Mufflers 213
 Multi-disc Clutches /Primary Drives 317
 Nameplates 832
 Nipple Screw Units 441
 Nuts 795

O

Oil - PETRONAS LINX 992
 Oil Dosage Beakers 804
 Oil Filters CHAMPION 206
 Oil Filters NYPSO 178
 Oil Filters UFI 188
 Oil Pump Chains 56
 Oil Seals - Search by Misuares 114
 Oil Seals Sets 107
 Oxygen Sensors 916

P-R

Pedals 827
 Pick Up 968
 Pinion Starters 305
 Piston Kits 43
 Piston Rings 43
 Plate Holders 829
 Platiners 987
 Profiles Vespa 825
 Pulley - Kits 273
 Pulley Fans 275
 Rear View Mirrors - MOTORBIKES 487
 Rear View Mirrors SCOOTER 454
 Rear Wheel Axles 323

Reed Valves 116
 Regulators 938
 Repair Kits for Tires 1016
 Resistors 914
 Resistors Blinkers 870
 Rock Wool Cartridge 214
 Roller Cages 102
 Roller Sets 276
 Roller Weight Housings 274
 Rubber Engine Mounts 324

S

Sensors 915
 Service Kits For Scooter 302
 Shock Absorbers Extensions 576
 Shock Absorbers FORSA 542
 Side Stands 527
 Sleeves 117
 Sliders 275
 Spark Plug CHAMPION 860
 Spark Plug Wrench 1015
 Spark Plugs Nypso 867
 Speedometer Cables 407
 Speedometer Pinions 443
 Speedometers Vespa 808
 Start Shafts 304
 Starter Gears Kits 315
 Starter Motors 947
 Starter Relay 924
 Starter Springs 308
 Starter Wheels 311
 Stators 957
 Steering Caps Sets 779
 Steering Covers 819
 Stop Switch 910
 Studs 796

T-U-V

Tail Lights 884
 Thermal Switches 96
 Thermostats 96
 Throttle Cables 422
 Throttles - DOMINO 388
 Tie Down 1018
 Timing Chain Guides Kit 66
 Timing Chains KMC 47
 Tires - Tubes KENDA 1022
 Tires Repair Kit AIRMAN 1019
 Transmission Cables – APE 446
 Transmission Cables - Scooters 317
 Transmission Cables – VESPA 436
 Upper Balls Cages 789
 Valve Seals 57
 Vespa Shift and Throttle Controls 445

W

Washers 790
 Water Pump Repair Kits 88
 Wheelrims 774
 Wiring Harness 982
 Workshop Tools-BIKESERVICE 1006
 WRAPPER Spray Paint 1000



ENGINE

Air Filters – Applications Table	147
Air Filters - RMS - UFI	124
Air Filters CHAMPION	161
Air Filters Quad	146
Air Filters Racing Type	122
Belts Ape - Moped	235
Belts Mixer - Distribution	235
Bush Starters	307
Crankshafts	20
Crankshafts Revision Kits	103
Cylinder Head Covers	326
Cylinder Heads	42
Cylinder Kits - Original Type	27
Cylinder Kits - Racing Scooter 50 cc.	39
Engine rubber parts	324
Fan Covers	326
Fuel Filters	202
Gasket Sets	68
Gear Selectors	320
Inlet Pipes	117
Intake bellows	117
Kick Starters	309
Mufflers	213
Oil Filters CHAMPION	206
Oil Filters NYPISO	178
Oil Filters UFI	188
Oil Pump Chains	56
Oil Seals - Search by Misuares	114
Oil Seals Sets	107
Pinion Starters	305
Piston Kits	43
Piston Rings	43
Reed Valves	116
Rock Wool Cartridge	214
Rubber Engine Mounts	324
Sleeves	117
Start Shafts	304
Starter Gears Kits	315
Starter Springs	308
Starter Wheels	311
Timing Chain Guides Kit	66
Timing Chains KMC	47
Valve Seals	57
Water Pump Repair Kits	88



TRANSMISSION

Ape Driveshaft Coupling	322
Belts DAYCO - RMS	216
Cables Motorbike	444
Chains KMC- AMC	330
Clutch Assy	236
Clutch Outers	246
Connecting Links (Chain)	331
Fixed Drive Half Pulley	257
Fixed Driven Half Pulley	268
Gear Box Selectors	321
Movable Drive Half Pulley	261
Movable Driven Half Pulley	271
Multi-disc Clutches /Primary Drives	317
Pulley - Kits	273
Pulley Fans	275
Rear Wheel Axles	323
Roller Sets	276
Roller Weight Housings	274
Service Kits For Scooter	302
Sliders	275
Transmission Cables - Scooters	317



CHASSIS

Brake Cables	418
Brake Cylinders	771
Brake Discs	754
Brake Drum	773
Brake Master Cylinders	772
Brake Pads Applications Table RMS - SINTER	618
Brake Pads Drawings RMS - SINTER	579
Brake Shoes	615
Cables VESPA	436
Carriers Vespa	829
Central Stands	514
Choke Cables	432
Clamps Terminals	441
Floor Mats Vespa	811
Footrest Stripes Vespa	826
Forks	775
Frame Rubbers Kit Vespa	810
Grips – DOMINO	396
Grips RMS	402
Handlebar Covers	817
Hardware	790
Lever Supports – DOMINO	385
Levers	342
Levers – Applications Table	361
Mudguards	820
Nipple Screw Units	441
Pedals	827
Plate Holders	829
Profiles Vespa	825
Rear View Mirrors - MOTORBIKES	487
Rear View Mirrors SCOOTER	454
Shock Absorbers Extentions	576
Shock Absorbers FORSA	542
Side Stands	527
Speedometer Cables	407
Speedometer Pinions	443
Speedometers Vespa	808
Steering Caps Sets	779
Steering Covers	819
Throttle Cables	422
Throttles - DOMINO	388
Tires - Tubes KENDA	1022
Transmission Cables – APE	446
Transmission Cables – VESPA	436
Upper Balls Cages	789
Vespa Shift and Throttle Controls	445
Wheelrims	774



ELECTRICAL SYSTEM

Batteries - BS	851
Batteries ELEKTRA	857
Blinker Lamps	869
Blinkers Relays	912
CDI	920
Coils	926
Condensators	986
Electrical Connectors	983
Electrical Devices – DOMINO	392
Fan Relay	915
Flywheels	965
Fuses	917
Head Lights	880
Horn Buttons	899
Horns	904
Ignition Coils BERU	933
Intermitences	912
Key Sets Main Switches - RMS - ZADI	970
Lamps	888
Led Conversion Kit	894

Lights Switches	899
Lithium Batteries LI-ON	846
Oxygen Sensors	916
Pick Up	968
Platiners	987
Regulators	938
Resistors	914
Resistors Blinkers	870
Sensors	915
Spark Plug CHAMPION	860
Spark Plugs Nypso	867
Starter Motors	947
Starter Relay	924
Stators	957
Stop Switch	910
Tail Lights	884
Thermal Switches	96
Thermostats	96
Wiring Harness	982



BODY WORK

Body Parts	810
Cylinder Locks – RMS – ZADI	979
Electric Fuel Pumps	805
Fuel - Oil Hoses	804
Fuel Taps – Pumps	801
Fuel, Oil and Brake Fluid Caps	807
Lens	875
Nameplates	832
Oil Dosage Beakers	804

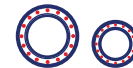

BEARINGS

Ball Bearings	98
Drawn Cups	102
Roller Cages	102



WORKSHOP TOOLS

Battery Chargers - BS	855
Battery Chargers - ELEKTRA	858
Chemical products for Motorcycles PETRONAS	991
Chemical products for Workshop AREXONS	994
First Aid Kit	1017
Flywheel Extractors	1014
Motorcycle Covers	1018
Oil - PETRONAS LINX	992
Repair Kits for Tires	1016
Spark Plug Wrench	1015
Tie Down	1018
Tires Repair Kit AIRMAN	1019
Workshop Tools-BIKESERVICE	1006
WRAPPER Spray Paint	1000



HARDWARE

Bolts	790
Nuts	795
Studs	796
Washers	790



SECURITY

Locks	1003
-------	------



A

Aceite motor – PETRONAS LINX 992
 Alfombrillas Vespa 811
 Amortiguadores FORSA 542
 Anagramas 832
 Aplicaciones Manetas de Freno 361
 Aplicaciones Pastillas de Freno RMS - SINTER 618
 Aros de Piston 43

B

Baterías – BS 851
 Baterías ELEKTRA 857
 Baterías Litio LI-ON 846
 Bobinas 926
 Bobinas de Encendido BERU 933
 Bombas de Gasolina 805
 Bombas Freno 772
 Bornes 441
 Boton Bocina 899
 Bujias CHAMPION 860

C

Caballetes Centrales 514
 Caballetes Laterales 527
 Cables Acelerador 422
 Cables Arranque 432
 Cables Cuentakm 407
 Cables Freno 418
 Cables Moto 444
 Cables Transmission Vespa 436
 Cables Vespa 436
 Cadenas Bomba Aceite 56
 Cadenas con Toricas 331
 Cadenas de Distribución KMC 47
 Cadenas Transmision KMC- AMC 330
 Caja de Laminas 117
 Caja del Eje de Arranque 307
 Caja del Eje Rueda Trasera 323
 Campana de Embrague 246
 Candados – Cadenas 1003
 Cargadores de Baterías - BS 855
 Cargadores de Baterías - ELEKTRA 858
 Casquete Direccion 779
 Centralinas Electronicas – CDI 920
 Cerraduras – RMS -ZADI 979
 Cerraduras de Contacto – RMS - ZADI 970
 Ciguenal 20
 Cilindros Frenos 771
 Claxons 904
 Cofia Cabeza Cilindro 326
 Cojinetes a Esferas 98
 Condensadores 986
 Conectores Eléctricos 983
 Correas Ape 235
 Correas Mezclador – Distribucion 235
 Correas para Transporte 1018
 Correas Transmision DAYCO - RMS 216
 Cruceta Cambio y Engranajes Cambio 320
 Cubierta Volante 326
 Cubiertas - Camaras KENDA 1022
 Cubre Direccion 819
 Cubre Manillares 817
 Cuentakilometros Vespa 808
 Culata 42
 Cuñas Remolques 275

D-E

Desviador Luces 899
 Detalles Chasis 810
 Discos Frenos 754
 Embragues Multidiscos 317

Engranajes Kit Arranque 315
 Esparragos 796
 Espejos Retrovisores MOTOCICLETA 487
 Espejos Retrovisores SCOOTER 454
 Estator 957
 Extractores Volantes 1014
 Estuche a Bobina/Rodillo 102

F

Filtros Aceite CHAMPION 206
 Filtros Aceite NYPSO 178
 Filtros Aceite UFI 188
 Filtros Aire - RMS - UFI 124
 Filtros Aire CHAMPION 161
 Filtros Aire Quad 146
 Filtros Aire Racing 122
 Filtros Gasolina 202
 Fundas Moto 1018
 Fusibles 917

G

Goma de Aspiracion 116
 Gomas de Cofano Vespa 825
 Gomas Varias - Piaggio 324
 Grifos y Bombas de Gasolina 801
 Grupo Termico 27
 Grupo Termico Racing 39
 Guaias de la Placa Portarodillos 274
 Guardabarros 820

H-I-J

Herramientas de Taller-BIKESERVICE 1006
 Horquillas 775
 Instalaciones Electricas 982
 Intermitentes Completos 869
 Interruptor Termico 915
 Interruptores Stop 910
 Jaula de Aguja 102
 Jogo de Rodillos 107

K

Kit de Juntas 68
 Kit de Primeros Auxilios 1017
 Kit de Reparacion Tubeless AIRMAN 1019
 Kit Estribos Vespa 826
 Kit Gomas Chasis Vespa 810
 Kit Guias Cadena de Distribucion 66
 Kit Polea Motriz 273
 Kit Repara-Pinchazos Tubeless 1016
 Kit Revision Bomba de Agua 88
 Kit Revision Eje Motor 103
 Kit Revision Scooter 302
 Kits de Conversion LED 894

L-M-P

Lamparas 888
 Lana Tubo de Escape 214
 Llantas 774
 Llaves Bujias 1015
 Llaves de Contacto 987
 Luz Delantera 880
 Luz Trasera 884
 Mando de Cambio y Gas 445
 Mandos Gas – DOMINO 388
 Manetas de Freno 342
 Medidor Centilitrato 804
 Mordaza 236
 Motor de Arranque 947
 Muelles de Arranque 308
 Partes de Transmission Ape 322

Pastillas de Freno RMS - SINTER 579
 Pedales de Arranque 827
 Pedales de Arranque 309
 Pick Up 968
 Piñon de Arranque 305
 Piñones Velocímetro 443
 Pinzas Frenos 615
 Pipas de Bujias 867
 Pistones 43
 Placa Portarodillos 275
 Portaequipajes Vespa 829
 Portamanetas – DOMINO 385
 Portamatricula 829
 Productos Químicos para Motocicleta 991
 PETRONAS
 Productos Químicos para Taller AREXONS 994
 Prolongadores de Amortiguador 576
 Puños – Domino 396
 Puños Electricos - Domino 392
 Puños RMS 402

R

Recolector Aspiracion-Escape 117
 Reguladores de Tension 938
 Reles Arranque 924
 Relés Intermitentes 912
 Reles Ventilador 96
 Resistencias 914
 Resistencias Intermitentes 870
 Retenes de la Valvula 57
 Retenes Ordenados por Medida 114
 Rodamientos 790
 Rodillos Variador 276
 Ruedas Libres de Arranque 311

S

Sector de Arranque 304
 Sectores Cambio 321
 Semi Poleas Conductas Corredizas 271
 Semi Poleas Conductas Fijas 268
 Semi Poleas Motrizes Corredizas 261
 Semi Poleas Motrizes Fijas 257
 Sensores 915
 Silenciadores 213
 Sondas Lambda 916
 Soportes Elasticos 324

T

Tabla de Aplicaciones de Filtros Aire 147
 Tambor de Freno 773
 Tapon Gasolina, Aceite Motor, Aceites 807
 Frenos
 Terminales Bornes 441
 Termostatos 96
 Toberas de Aspiracion 117
 Tornilleria 790
 Tornillos 790
 Transmisiones APE 446
 Transmisiones Primarias 317
 Tubo Gasolina-Aceite 804
 Tuercas 795
 Tuercas y Bulones 789
 Tulipas 875
 Tulipas Intermitencias 912

V-W

Volante Magnetico 965
 WRAPPER Pintura Spray 1000



MOTOR

Aros de Piston	43
Cadenas Bomba Aceite	56
Cadenas de Distribución KMC	47
Caja de Laminas	117
Caja del Eje de Arranque	307
Ciguenal	20
Cofia Cabeza Cilindro	326
Correas Ape	235
Correas Mezclador – Distribucion	235
Cruceta Cambio y Engranajes Cambio	320
Cubierta Volante	326
Culata	42
Engranajes Kit Arranque	315
Filtros Aceite CHAMPION	206
Filtros Aceite NYPPO	178
Filtros Aceite UFI	188
Filtros Aire - RMS - UFI	124
Filtros Aire CHAMPION	161
Filtros Aire Quad	146
Filtros Aire Racing	122
Filtros Gasolina	202
Goma de Aspiracion	116
Gomas Varias - Piaggio	324
Grupo Termico	27
Grupo Termico Racing	39
Jogo de Rodillos	107
Kit de Juntas	68
Kit Guías Cadena de Distribucion	66
Kit Revision Bomba de Agua	88
Kit Revision Eje Motor	103
Lana Tubo de Escape	214
Muelles de Arranque	308
Pedales de Arranque	309
Piñon de Arranque	305
Pistones	43
Recolector Aspiracion-Escape	117
Retenes de la Valvula	57
Retenes Ordenados por Medida	114
Ruedas Libres de Arranque	311
Sector de Arranque	304
Silenciadores	213
Soportes Elasticos	324
Tabla de Aplicaciones de Filtros Aire	147
Toberas de Aspiracion	117



TRANSMISION

Cables Moto	444
Cadenas con Toricas	331
Cadenas Transmision KMC- AMC	330
Caja del Eje Rueda Trasera	323
Campana de Embrague	246
Correas Transmision DAYCO - RMS	216
Cuñas Remolques	275
Embragues Multidiscos	317
Guaias de la Placa Portarodillos	274
Kit Polea Motriz	273
Kit Revision Scooter	302
Mordaza	236
Partes de Transmision Ape	322
Placa Portarodillos	275
Rodillos Variador	276
Sectores Cambio	321
Semi Poleas Conductas Corredizas	271
Semi Poleas Conductas Fijas	268
Semi Poleas Motrizes Corredizas	261
Semi Poleas Motrizes Fijas	257
Transmisiones Primarias	317



CHASIS

Alfombrillas Vespa	811
Amortiguadores FORSA	542
Aplicaciones Manetas de Freno	361
Aplicaciones Pastillas de Freno RMS - SINTER	618
Bombas Freno	772
Bornes	441
Caballetes Centrales	514
Caballetes Laterales	527
Cables Acelerador	422
Cables Arranque	432
Cables Cuentakm	407
Cables Freno	418
Cables Transmission Vespa	436
Cables Vespa	436
Casquete Direccion	779
Cilindros Frenos	771
Cubiertas - Camaras KENDA	1022
Cubre Direccion	819
Cubre Manillares	817
Cuentakilometros Vespa	808
Discos Frenos	754
Espejos Retrovisores MOTOCICLETA	487
Espejos Retrovisores SCOOTER	454
Gomas de Cofano Vespa	825
Guardabarros	820
Horquillas	775
Kit Estribos Vespa	826
Kit Gomas Chasis Vespa	810
Llantas	774
Mando de Cambio y Gas	445
Mandos Gas - DOMINO	388
Manetas de Freno	342
Pastillas de Freno RMS - SINTER	579
Pedales de Arranque	827
Piñones Velocímetro	443
Pinzas Frenos	615
Portaequipajes Vespa	829
Portamanetas - DOMINO	385
Portamaticula	829
Prolongadores de Amortiguador	576
Puños - Domino	396
Puños RMS	402
Tambor de Freno	773
Terminales Bornes	441
Tornilleria	790
Transmisiones APE	446
Tuercas y Bulones	789



INSTALACION ELECTRICA

Baterias - BS	851
Baterias ELEKTRA	857
Baterias Lito LI-ON	846
Bobinas	926
Bobinas de Encendido BERU	933
Boton Bocina	899
Bujias CHAMPION	860
Centralinas Electronicas - CDI	920
Cerraduras de Contacto - RMS - ZADI	970
Claxons	904
Condensadores	986
Conectores Eléctricos	983
Desviador Luces	899
Estator	957
Fusibles	917
Instalaciones Electricas	982
Intermitentes Completos	869
Interruptor Termico	915
Interruptores Stop	910

Kits de Conversion LED	894
Lamparas	888
Llaves de Contacto	987
Luz Delantera	880
Luz Trasera	884
Motor de Arranque	947
Pick Up	968
Pipas de Bujias	867
Puños Electricos - Domino	392
Reguladores de Tension	938
Reles Arranque	924
Relés Intermitentes	912
Reles Ventilador	96
Resistencias	914
Resistencias Intermitentes	870
Sensores	915
Sondas Lambda	916
Termostatos	96
Tulipas Intermitencias	912
Volante Magnetico	965



CARROCERIA

Anagramas	832
Bombas de Gasolina	805
Cerraduras - RMS - ZADI	979
Detalles Chasis	810
Grifos y Bombas de Gasolina	801
Medidor Centilitrato	804
Tapon Gasolina, Aceite Motor, Aceites Frenos	807
Tubo Gasolina-Aceite	804
Tulipas	875

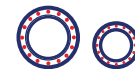

COJINETES

Cojinetes a Esferas	98
Estuche a Bobina/Rodillo	102
Jaula de Aguja	102



HERRAMIENTAS OFICINA

Aceite motor - PETRONAS LINX	992
Cargadores de Baterias - BS	855
Cargadores de Baterias - ELEKTRA	858
Correas para Transporte	1018
Estractores Volantes	1014
Fundas Moto	1018
Herramientas de Taller-BIKESERVICE	1006
Kit de Primeros Auxilios	1017
Kit de Reparacion Tubeless AIRMAN	1019
Kit Repara-Pinchazos Tubeless	1016
Llaves Bujias	1015
Productos Quimicos para Motocicleta	991
PETRONAS	
Productos Quimicos para Taller AREXONS	994
WRAPPER Pintura Spray	1000



TORNILLERIA

Esparragos	796
Rodamientos	790
Tornillos	790
Tuercas	795



SEGURIDAD

Candados - Cadenas	1003
--------------------	------



A

Aceite motor – PETRONAS LINX	992
Alfombrillas Vespa	811
Amortiguadores FORSA	542
Anagramas	832
Aplicaciones Manetas de Freno	361
Aplicaciones Pastillas de Freno RMS - SINTER	618
Aros de Piston	43

B

Baterías – BS	851
Baterías ELEKTRA	857
Baterías Litio LI-ON	846
Bobinas	926
Bobinas de Encendido BERU	933
Bombas de Gasolina	805
Bombas Freno	772
Bornes	441
Boton Bocina	899
Bujias CHAMPION	860

C

Caballetes Centrales	514
Caballetes Laterales	527
Cables Acelerador	422
Cables Arranque	432
Cables Cuentakm	407
Cables Freno	418
Cables Moto	444
Cables Transmission Vespa	436
Cables Vespa	436
Cadenas Bomba Aceite	56
Cadenas con Toricas	331
Cadenas de Distribución KMC	47
Cadenas Transmision KMC- AMC	330
Caja de Laminas	117
Caja del Eje de Arranque	307
Caja del Eje Rueda Trasera	323
Campana de Embrague	246
Candados – Cadenas	1003
Cargadores de Baterías - BS	855
Cargadores de Baterías - ELEKTRA	858
Casquete Direccion	779
Centralinas Electronicas – CDI	920
Cerraduras – RMS -ZADI	979
Cerraduras de Contacto – RMS - ZADI	970
Ciguenal	20
Cilindros Frenos	771
Claxons	904
Cofia Cabeza Cilindro	326
Cojinetes a Esferas	98
Condensadores	986
Conectores Eléctricos	983
Correas Ape	235
Correas Mezclador – Distribucion	235
Correas para Transporte	1018
Correas Transmision DAYCO - RMS	216
Cruceta Cambio y Engranajes Cambio	320
Cubierta Volante	326
Cubiertas - Camaras KENDA	1022
Cubre Direccion	819
Cubre Manillares	817
Cuentakilometros Vespa	808
Culata	42
Cuñas Remolques	275

D-E

Desviador Luces	899
Detalles Chasis	810
Discos Frenos	754
Embragues Multidiscos	317

Engranajes Kit Arranque	315
Esparragos	796
Espejos Retrovisores MOTOCICLETA	487
Espejos Retrovisores SCOOTER	454
Estator	957
Estractores Volantes	1014
Estuche a Bobina/Rodillo	102

F

Filtros Aceite CHAMPION	206
Filtros Aceite NYPSO	178
Filtros Aceite UFI	188
Filtros Aire - RMS - UFI	124
Filtros Aire CHAMPION	161
Filtros Aire Quad	146
Filtros Aire Racing	122
Filtros Gasolina	202
Fundas Moto	1018
Fusibles	917

G

Goma de Aspiracion	116
Gomas de Cofano Vespa	825
Gomas Varias - Piaggio	324
Grifos y Bombas de Gasolina	801
Grupo Termico	27
Grupo Termico Racing	39
Guaias de la Placa Portarodillos	274
Guardabarros	820

H-I-J

Herramientas de Taller-BIKESERVICE	1006
Horquillas	775
Instalaciones Electricas	982
Intermitentes Completos	869
Interruptor Termico	915
Interruptores Stop	910
Jaula de Aguja	102
Jogo de Rodillos	107

K

Kit de Juntas	68
Kit de Primeros Auxilios	1017
Kit de Reparacion Tubeless AIRMAN	1019
Kit Estribos Vespa	826
Kit Gomas Chasis Vespa	810
Kit Guias Cadena de Distribucion	66
Kit Polea Motriz	273
Kit Repara-Pinchazos Tubeless	1016
Kit Revision Bomba de Agua	88
Kit Revision Eje Motor	103
Kit Revision Scooter	302
Kits de Conversion LED	894

L-M-P

Lamparas	888
Lana Tubo de Escape	214
Llantas	774
Llaves Bujias	1015
Llaves de Contacto	987
Luz Delantera	880
Luz Trasera	884
Mando de Cambio y Gas	445
Mandos Gas – DOMINO	388
Manetas de Freno	342
Medidor Centilitrato	804
Mordaza	236
Motor de Arranque	947
Muelles de Arranque	308
Partes de Transmission Ape	322

Pastillas de Freno RMS - SINTER	579
Pedales de Arranque	827
Pedales de Arranque	309
Pick Up	968
Piñon de Arranque	305
Piñones Velocímetro	443
Pinzas Frenos	615
Pipas de Bujias	867
Pistones	43
Placa Portarodillos	275
Portaequipajes Vespa	829
Portamanetas – DOMINO	385
Portamatricula	829
Productos Quimicos para Motocicleta	991
PETRONAS	
Productos Quimicos para Taller AREXONS	994
Prolongadores de Amortiguador	576
Puños – Domino	396
Puños Electricos - Domino	392
Puños RMS	402

R

Recolector Aspiracion-Escape	117
Reguladores de Tension	938
Reles Arranque	924
Relés Intermitentes	912
Reles Ventilador	96
Resistencias	914
Resistencias Intermitentes	870
Retenes de la Valvula	57
Retenes Ordenados por Medida	114
Rodamientos	790
Rodillos Variador	276
Ruedas Libres de Arranque	311

S

Sector de Arranque	304
Sectores Cambio	321
Semi Poleas Conductas Corredizas	271
Semi Poleas Conductas Fijas	268
Semi Poleas Motrizes Corredizas	261
Semi Poleas Motrizes Fijas	257
Sensores	915
Silenciadores	213
Sondas Lambda	916
Soportes Elasticos	324

T

Tabla de Aplicaciones de Filtros Aire	147
Tambor de Freno	773
Tapon Gasolina, Aceite Motor, Aceites	807
Frenos	
Terminales Bornes	441
Termostatos	96
Toberas de Aspiracion	117
Tornilleria	790
Tornillos	790
Transmisiones APE	446
Transmisiones Primarias	317
Tubo Gasolina-Aceite	804
Tuercas	795
Tuercas y Bulones	789
Tulipas	875
Tulipas Intermitencias	912

V-W

Volante Magnetico	965
WRAPPER Pintura Spray	1000



MOTEUR

Axe de Kick	304
Boite de Demarrage	307
Caoutchouc d'Admission	117
Capot du Volant	326
Chaines de Distribution KMC	47
Clapets	116
Coiffe Culasse	326
Courroie Ape - Cyclomoteur	235
Courroie de Mélangeur et de Distribution	235
Croisillons	320
Culasse	42
Echappements	213
Engrenage Roue Démarrage	315
Ensembles de Pistons	43
Filtre à air - RMS - UFI	124
Filtre à Air - Tableau d'Applications	147
Filtre à air CHAMPION	161
Filtre à Air Quad	146
Filtre à Air Racing	122
Filtre à Huile CHAMPION	206
Filtre à Huile NYPSO	178
Filtre à Huile UFI	188
Filtre Essence	202
Joint d'Huile - tableau par dimension	114
Joints des Vannes	57
Kick Demarrage	309
Kit Cylindre - Racing scooter 50 cc.	39
Kit Cylindre - Type Original	27
Kit Guides Chaines de Distribution	66
Kit Joints	68
Kit Joints d'Huile	107
Kit Reparation Pompe à Eau	88
Kit Reparation Vilebrequins	103
Laine de Roche	214
Manchon Vanne	117
Noix de Kick	305
Pièces en Caoutchouc pour Moteur	324
Pipes d'Admission	117
Pistons	43
Pompe Huile Chaines	56
Ressort de Kick	308
Roue Libre Demarreur	311
Supports de Moteur en Caoutchouc	324
Vilebrequins	20



TRANSMISSION

Axe de Roue Arrière	323
Cables Moto	444
Chaines Joints	331
Cloche Embrayage	246
Courroies DAYCO - RMS	216
Embrayages	236
Embrayages Multi-Disque	317
Fan de Variateur	275
Flasque Variateur Fixe Arriere	268
Flasque Variateur Fixe Avant	257
Flasque Variateur Mobile Arriere	271
Flasque Variateur Mobile Avant	261
Galet Variateur	276
Guide Vario	274
Joint Transmission Ape	322
Kit Entretien	302
Kit variateur	273
Plateau Appui Galets	275
Secteurs Vitesse	321
Transmission Chaines KMC- AMC	330
Transmission Compteur Km.	317



CHASSIS

Ammortisseurs FORSA	542
Béquilles Centrales	527
Béquilles Latérales	514
Bornier	441
Cable Transmission Ape	446
Cable Transmission Vespa	436
Cable Vespa	436
Cables Compteur	407
Cables de Demarreur	432
Cables de Frein	418
Cables de Gaz	422
Caches Direction	819
Compteurs de vitesse Vespa	808
Cosses et Bornes	441
Couvres Guidon	817
Cylindre du Frein	771
Disques Frein	754
Durite Poignee/Gaz Vespa	445
Ecrou - Boulons	789
Fourches	775
Frein à Tambour	773
Garde-boues	820
Jantes	774
Jeu de Baguettes Vespa	826
Kit Caoutchouc Chassis Vespa	810
Leviers Freinage	342
Leviers Freinage - Tableau d'Applications	361
Machoirs de Freins	615
Pédales	827
Pignons Compteurs de Vitesse	443
Plaquettes de Freins-Applications RMS-SINTER	618
Plaquettes de Freins RMS - SINTER	579
Pneumatiques - KENDA	1022
Poignées de Gaz - DOMINO	388
Pompes Freins	772
Porte Plaque	829
Porte-bagages Vespa	829
Profilés Vespa	825
Rallonge Amortisseur	576
Retroviseurs MOTO	487
Retroviseurs SCOOTER	454
Revetements - DOMINO	396
Revetements RMS	402
Roulements de Direction	779
Support de Levier - DOMINO	385
Tapis de sol Vespa	811
Visserie	790



ÉLECTRICITÉ

Ampoule	888
Batteries - BS	851
Batteries ELEKTRA	857
Batteries Lithium LI-ON	846
Bobines d'Allumage BERU	933
Bobines HT	926
Bougies CHAMPION	860
Cablage	982
Capteur	968
Capteurs	915
Capuchon bougies	867
CDI	920
Clignotants	869
Commutateur Feu	899
Commutateur Stop	910
Condensateur	986
Connecteurs Electriques	983
Contacteur Thermique	915
Contacteurs - RMS - ZADI	970

Demarreur électrique	947
Dispositifs électriques - DOMINO	392
Fan de Relais	96
Feux Arrieres	884
Feux Intermittentes	912
Fusibles	917
Interrupteur Klaxon	899
Kit de Transformation LED	894
Klaxon	904
Optique	880
Régulateurs de Tension	938
Relais de Clignotants	912
Relais Demarrage	924
Résistances	914
Résistances Clignotants	870
Sondes Lambda	916
Stator	957
Thermostat	96
Vis platiné	987
Volant	965



CARROSSERIE

Bouchons Essence, Huile Moteur, Huile Freins	807
Cabochons de Clignotant	875
Doseur	804
Durite Essence - Huile	804
Insignes de Carrosserie	832
Kit de Serrure - RMS - ZADI	979
Pièces de Carrosserie	810
Pompe a Essence	805
Robinet - Pompe a Essence	801

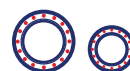

ROULEMENT

Cage à Aiguilles	102
Roulements à Billes	98
Roulements à Rouleaux	102



OUTILLAGE ATELIER

Chargeurs de Batteries - BS	855
Chargeurs de Batteries - ELEKTRA	858
Clé a Bougie	1015
Extracteur Volant Magnétique	1014
Housses Moto	1018
Huile Moteur - PETRONAS LINX	992
Kit de Premiers Secours	1017
Kit Reparation Tubeless	1016
Kit Reparation Tubeless AIRMAN	1019
Outillage-BIKESERVICE	1006
Peinture WRAPPER	1000
Produits Chimiques pour Atelier AREXONS	994
Produits Chimiques pour Moto PETRONAS	991
Sangles de Transport	1018



VISSERIE

Boulons	795
Ecrous	790
Goujons	796
Rondelles	790



ANTIVOLS

Chaines Antivol	1003
-----------------	------



RMS

YOUR BEST PARTNER

▶ NUOVI PRODOTTI

NEW PRODUCTS

▶ **FERODO**

▶ **JT**

▶ **YSS**
SUSPENSION

ECO-FRICTION®

GREENER & SAFER



FERODO ECOLOGICAL
TECHNOLOGY



Le pastiglie freno Ferodo ECO-FRICTION® non solo offrono le migliori prestazioni in frenata di **categoria**, ma sono anche **ecologiche**.

Ferodo ECO-FRICTION® brake pads not only deliver **best-in class** stopping performance, they are also **greener** for the environment.

WWW.FERODORACING.COM / WWW.RMS.IT

FERODO®

The Ferodo brand is a registered trademark of  **FEDERAL-MOGUL
MOTORPARTS**

MAXIMUM DURABILITY

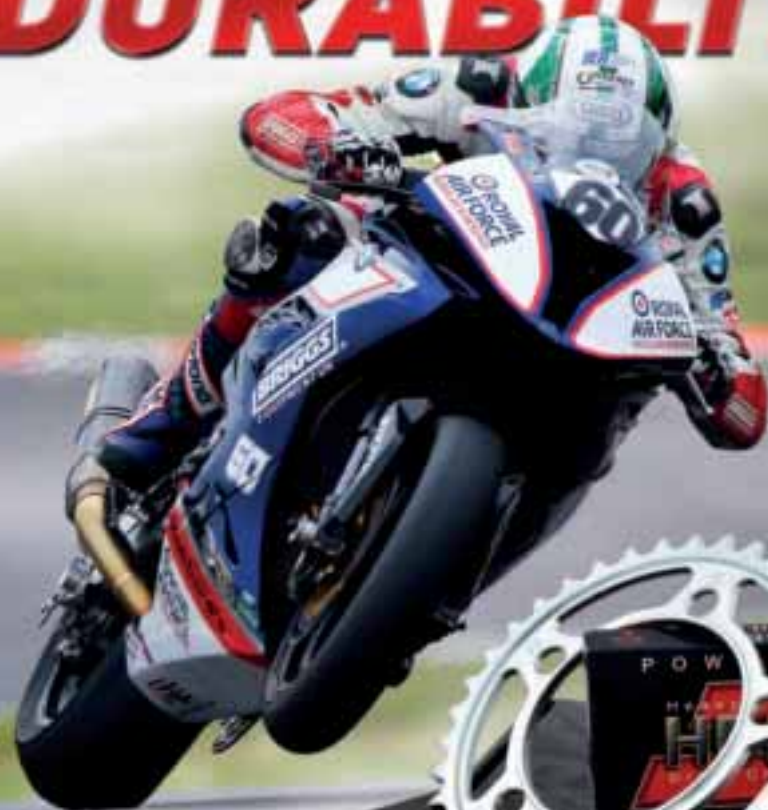

SCEGLI UN KIT DAVVERO UNICO!
CATENA + CORONA + PIGNONE

CHOOSE YOUR UNIQUE KIT!
CHAIN + FRONT AND REAR SPROCKETS

Scopri tutti i **PRODOTTI**
sul **CONFIGURATORE**
nell'area riservata del sito: www.rms.it

Check out all **PRODUCTS**
on our **CONFIGURATOR**
in the restricted area of the site: www.rms.it



YSS

SUSPENSION

WORLD CLASS SUSPENSION



Scopri tutti i **PRODOTTI**
sul **CONFIGURATORE**
nell'area riservata
del sito: www.rms.it

Check out all **PRODUCTS**
on our **CONFIGURATOR**
in the restricted area
of the site: www.rms.it

▶ ALBERI MOTORE
CRANKSHAFTS

▶ CILINDRI
CYLINDER KITS

▶ PISTONI
PISTON KITS

▶ **RMS**
YOUR BEST PARTNER

▶ **FEDERAL
MOGUL**

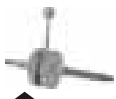

MINARELLI VERTICALE - VERTICAL

SPINOTTO Ø 10 MM. - PIN Ø 10 MM

APRILIA 50: Amico 94-98 • Amico Gl-Gle 93-95 • Amico Lx • Sport-Cat 92-93 • Sr 93

ITALJET 50: Pista 2 • Scoop 2-3 • Yankee 95-96

MBK 50: Cw Booster 90-94 • Cw Booster 01-02 • Cw Booster Naked 03 • Cw Booster Spirit 96-00 • Cw Booster Spirit Euro2 02-03 • Cw L Booster 01-03 • Cw L Booster Spirit 03 • Cw R Booster Road 94-95 • Cw Rs Booster Ng 95-99 • Cw Rs Booster Ng 01-02 • Cw Rs Booster Ng Euro1 99-00 • Cw Rsp Booster Rocket 97-98 • Cw Rsx Booster Track 96-98 • Ew Stunt 00-02

YAMAHA 50: Bw's Bump 97-98 • Bw's Naked 03 • Bw's Next Generation 97-02 • Bw's Next Generation Cat 99-00 • Bw's Original 97-02 • Bw's Original Euro2 03 • Bw's R 01 • Cw Bw's Original Euro2 02 • Cw L Bw's 03 • Cw Rs Spy 95-98 • Ew Slider 00-02

STANDARD

BILANCIATO • BIELLA LUCIDATA • GABBIA A RULLI HQ
BALANCED • POLISHED CON ROD • HQ CAGE

INSERTO IN NYLON
WITH LINER

10 001 0010



10 001 0011



*

10 003 0010



*

10 003 0011



MINARELLI ORIZZONTALE - HORIZONTAL

SPINOTTO Ø 10 MM. - PIN Ø 10 MM

APRILIA 50: Gulliver 95-98 • Gulliver Lc 96-98 • Rally 95-03 • Rally Liquid Cooled 96-99 • Scarabeo 93-05 • Sonic 98-07 • Sr 94-96 • Sr Liquid Cooled 94-96 • Sr Www 97-01

BENELLI 50: 491 Gt 98-99 • 491 St 99-01 • K2 98-01 • Naked • Pepe 99-01 • Pepe Lx 03-04

BETA 50: Ark Air 96-08 • Ark Lc 03 • Ark Lc Serie K 04-08 • Eikon 99-03 • Quadra Chrono 502 95-99 • Tempo 94-99

MALAGUTI 50: Centro Base 93-94 • Ciak 99-00 • Ciak Master 04 • Ciak Mono Euro2 03 • Ciak Mono Euro 2.2.3 03 • F10 Rst Euro1 01-02 • F10 Rst Euro2 02-03 • F10 Rst Euro 2.2.3 03-04 • F12 Aria Rst Euro1 06 • F12 Phantom Rst Euro1 01-02 • F12 Phantom Rst Euro 2.2.3 03-04 • F15 Fire Fox Air Cooled 06 • F15 Fire Fox Euro2 02-03-F15 Fire Fox Twin Disks & Special 98-99 • Yesterday-Yesterday Euro 97-00

MBK 50: Ya R Forte 94-96 • Ye Evolis 92-95 • Yh Flipper 98 • Yh Flipper 01-02 • Yh Flipper Catalitico 99-00 • Ym Fizz 94-95 • Yo Nitro 97-01 • Yo Nitro Euro2 03

YAMAHA 50: Aerox 97-98 • Aerox R 99-00 • Cs Jog R 02 • Yh Why 98 • Yh Why 01-02 • Yh Why Euro1 99-00 • Ym Breeze 94-95 • Ym Neo's Euro2 99

STANDARD

BILANCIATO • BIELLA LUCIDATA • GABBIA A RULLI HQ
BALANCED • POLISHED CON ROD • HQ CAGE

INSERTO IN NYLON
WITH LINER

10 001 0030



10 001 0031



*

10 003 0030



*

10 003 0031





MINARELLI AM6 - AM345

APRILIA - BETA - MALAGUTI - MBK
YAMAHA: MINARELLI AM345-AM6 50 cc.

STANDARD

10 001 0050



10 020 0830



10 015 0010

APRILIA-PIAGGIO-GILERA 2T 50 CC

APRILIA 50: Sr Street 03-08 • Sr R R Factory 04-09 • Sr R • Factory Ie e Carburatore 10
GILERA 50: Runner Purejet 02-10 • Runner Purejet St 08
PIAGGIO 50: Nrg Power Purejet 04-06-Nrg Purejet 02
 (R.O. 8269405)

STANDARD

10 001 0310



APRILIA-PIAGGIO-GILERA 4T 50 CC

SEDE CUSCINETTO LATO FRIZIONE Ø 25 MM.
BEARING SEAT CLUTCH SIDE Ø 25 MM
APRILIA 50: Scarabeo 4t 02-06
PIAGGIO 50: Liberty 4t 00-02-Vespa Et4 00-05 • Zip 4t 00-05
 (R.O. 969203)

STANDARD

10 001 0320



APRILIA - PIAGGIO - GILERA 2T 50 CC

APRILIA 50: Mojito 04-08 • Scarabeo Street 2T Restyling 06-09 • Scarabeo Street 05-06
DERBI 50: Atlantis 2t Eu2 07-09 • Atlantis Bullet 03-05 • Atlantis City 03-06 • Atlantis 02 • Gp1 01-03
GILERA 50: Dna 00-02 • Dna Gp Experience 03-04 • Easy Moving 95-96 • Ice 01-05 • Runner 97-00 • Runner Poggiali 02 • Stalker 97-04 • Stalker Naked 08 • Storm 94-95 • Typhoon 94-97 • Typhoon X 98-99 • Typhoon Xr 00
PIAGGIO 50: Diesis 01 • Fly 2t 05-07 • Free 92 • Free Delivery 00-01 • Free FL 95-02 • Liberty 97-05 • Liberty 2t Rst 04 • Liberty 2t Sport 07-08 • Liberty Ptt Eu2 04-05 • Nrg 94-96 • Nrg Extreme 99-00 • Nrg Mc3 01-04 • Nrg Power Dt 06 • Nrg Rst Mc2 96-98 • Ntt 95-96 • Quartz 92-96 • Sfera 91-93 • Sfera Maquillage 2 94 • Sfera Rst 95-97 • Typhoon 01-08 • Vespa Et2 97-05 • Vespa Lx 2t FL 09 • Vespa S 2t 07-08 • Zip 92-93 • Zip 00-04 • Zip 95-96 • Zip Bimodale 94-97 • Zip Fast Rider 93-94 • Zip Fast Rider Rst 96-97 • Zip Rst 96-99 • Zip Sp 96-00
 (R.O. 4316255)

STANDARD

BILANCIATO • BIELLA LUCIDATA • GABBIA A RULLI HQ
BALANCED • POLISHED CON ROD • HQ CAGE

INSERTO IN NYLON
WITH LINER

10 001 0200



* **10 003 0200**



* **10 003 0201**



10 020 0300 SKF (Nylon)
10 020 0310 SKF (Acciaio - Steel)
10 020 0312 NTN



10 015 0300



ALBERI MOTORE

CRANKSHAFTS

APRILIA - PIAGGIO 4T 50 CC

SEDE CUSCINETTO LATO FRIZIONE Ø 20 MM
BEARING SEAT CLUTCH SIDE Ø 20 MM

APRILIA 50: Scarabeo 4t 02-06 • Scarabeo 4t Restyling Eu 3 06-09 • Scarabeo 4t 4V Net 10 • Scarabeo Quattro 09 • Sport City 4t 08 (R.O. 969428)

DERBI 50: Atlantis 4t Eu2 07 • Atlantis 4t 04-06

PIAGGIO 50: Fly 4t 05-08 • Vespa Lx 4t 05-08 • Vespa S 4t 4v 08-09 • Zip 4t 00-08 • Liberty 4t 05-08 • Rst 04 • 4t Delivery 09 (R.O. 969428)

STANDARD

10 001 0350



APRILIA - DERBI 4T 100 CC

APRILIA 100: Scarabeo 4T Net 10 • 4T Restyling 06/09-4T 10

DERBI 100: Atlantis 4T 04-06 • Boulevard 4T 10
PIAGGIO 100: Fly 4T 06-07 • Zip 4T 06-10 (R.O. 9699585)

STANDARD

10 001 0420



HONDA 2T 50 CC

CUSCINETTO LATO FRIZIONE E VOLANO
Ø 25 MM
BEARING SEAT CLUTCH AND FLYWHEEL SIDE
Ø 25 MM

HONDA 50: Sh 96-Sky-X8R

STANDARD

10 001 0110



HONDA 2T 50 CC

CUSCINETTO LATO FRIZIONE E VOLANO
Ø 20 MM

BEARING SEAT CLUTCH AND FLYWHEEL SIDE
Ø 20 MM

HONDA 50: Sfx-Balj

STANDARD

10 001 0120



HONDA 4T 150 CC

HONDA 150: Sh

STANDARD

10 001 0150



KYMCO 2T 50 CC

KYMCO 50: B&W 02 • B&W Euro2 03 • Dink 98-02 • Dink Classic Euro2 03 • Heroism 95-97 • People 99-00 • People 04 • People Euro2 03-08 • People S 05-08 • Sniper 93 • Sniper Dd 94-96 • Super 9 00 • Super 9 Sport Euro2 03-04 • Top Boy 97-00 • Vitality 2t 04 • Yup 02 • Yup Euro2 03 (R.O. 00110201)

STANDARD

10 001 0340



10 020 0692



KYMCO 4T 50 CC

KYMCO 50: Agility 4T R10 06-08 • Agility R12 05 • Filly Lx 01-02 • Filly 98-00 • Super 8 07 (R.O. 00103629)

STANDARD

10 001 0450 

10 001 0470  



MALAGUTI 2T 50 CC

LUNGHEZZA PERNO LATO FRIZIONE 110 MM
CLUTCH SIDE LENGHT 110 MM
MALAGUTI 50: F12 Phantom Lc Euro1 99-00-F12 Phantom Lc Euro 2 02 • F12 Phantom Lc Restyling Euro1 01-02- F12 Phantom Lc Restyling Euro2-2.3 03-04 • (R.O. 77116200)

STANDARD

10 001 0330 



MALAGUTI 2T 50 CC

MALAGUTI 50: F12 R Phantom Ac 07-10 (R.O. 59012200)

STANDARD

10 001 0040 



PEUGEOT 2T 50 CC

PEUGEOT 50: Ludix

STANDARD

10 001 0400 



PEUGEOT 2T 50 CC

PEUGEOT 50: Buxy 94-97 • Elyseo 99 • Looxor 01-03 • Metal X 02 • Speedfight Acqua 92-98 • Speedfight Aria 97-98 • Speedfight Aria Catalitico 99 • Squab 95-97 • Trekker 98-00 • Vivacity 99 • Vivacity Catalitico 99-02 • Vivacity VsX-Xr 02-04 • X-Fight 00 • Xrace 03 • Zemith N 97-98 • Zenith L 94-96 • Zenith Ln-Ls 97-98

BILANCIATO • BIELLA LUCIDATA • GABBIA A RULLI HQ
BALANCED • POLISHED CON ROD • HQ CAGE

INSERTO IN NYLON
WITH LINER

* **10 003 0130** 

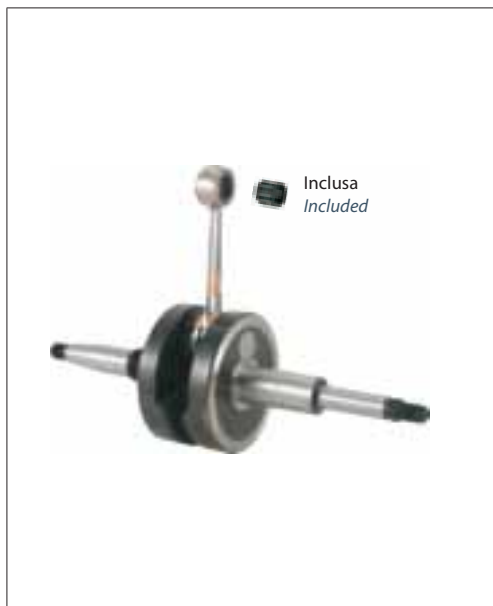

* **10 003 0131** 



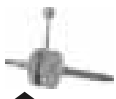

ALBERI MOTORE
CRANKSHAFTS

PIAGGIO VESPA 2T 125 CC

PIAGGIO 125: Vespa Primavera 125 67-83 • Vespa 125 Et3 67-83 • Vespa Pk 125 82-85 (R.O. 123296)

STANDARD

10 001 0250



BILANCIATO • BIELLA LUCIDATA • GABBIA A RULLI HQ
BALANCED • POLISHED CON ROD • HQ CAGE

* **10 003 0250**



Inclusa
Included



Inclusa
Included



10 020 0830

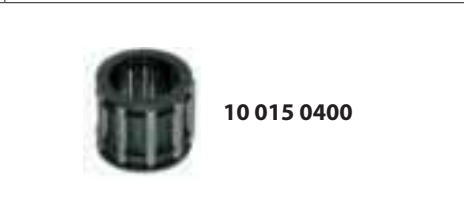

10 015 0400

PIAGGIO VESPA PK 2T 50 CC

CONO PICCOLO A DUE GABBIE
SMALL CONE FLYWHEEL SIDE
PIAGGIO 50: Vespa 50 67-82 • Vespa Pk 50 82-85 - (R.O. 123292)

STANDARD

10 001 0230



Inclusa
Included



10 020 0810

10 015 0250

PIAGGIO VESPA PK 2T 50 CC

CONO VOLANO GROSSO
BIG CONE FLYWHEEL SIDE
PIAGGIO 50: Vespa FL 90 • Vespa N 89-90 • Vespa Pk 50 82-84 • Vespa Pk XL 85-88 • Vespa Pk XI Rush 88-89 (R.O. 224587)

STANDARD

10 001 0240



Inclusa
Included



10 020 0820

10 015 0300

PIAGGIO VESPA PX 125-150 CC

PIAGGIO 125: Vespa Px 98-01 • Vespa Px 30 Anni 07-08 • Vespa Px Euro2 01-07 • Vespa Pxe 81-97
150: Vespa Px 98-01 • Vespa Pxe 81-97 (R.O. 133154)

STANDARD

10 001 0270



Inclusa
Included

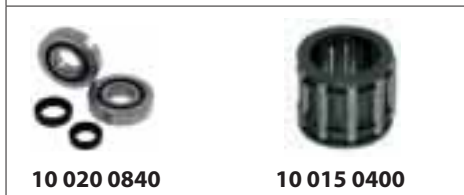

10 020 0840

10 015 0400

PIAGGIO VESPA PE 200 CC

PIAGGIO 200: Vespa PE • Cosa (R.O. 1331535)

STANDARD

10 001 0280



Inclusa
Included



10 020 0860

10 015 0450



PIAGGIO VESPA GL SPRINT 150 CC

PIAGGIO 150: Vespa GL Sprint
 (R.O. 131321)

STANDARD

10 001 0290 



10 020 0850



10 015 0400

PIAGGIO VESPA PK 50-125 CC

CONO GROSSO - BIG CONE
PIAGGIO: Vespa Pk 50 A 125 XL

BILANCIATO - BIELLA LUCIDATA
• GABBIA A RULLI HQ
BALANCED • POLISHED CON ROD • HQ CAGE

* **10 003 0310** 



10 020 0820



10 015 0400

PIAGGIO APE 50 CC

PIAGGIO 50: Ape Eu 2 03-10
 (R.O.8462675)

STANDARD

10 001 0410 



10 020 0770



10 015 0300

PIAGGIO SI - BRAVO 2T 50 CC

PIAGGIO 50: Bravo Erre 2 75-81 • Ciao 80-88 • Ciao Euro1 99-01 • Ciao Euro2 02-04 • Ciao Tre 71-99 • Grillo 89-93-Si 79-88 • Si FI2 91-97
 (R.O. 184154) Spinotto Ø 10 mm. - Pin Ø 10 mm
 (R.O. 113708) Spinotto Ø 12 mm. - Pin Ø 12 mm

STANDARD
 SPINOTTO Ø 10 MM. - PIN Ø 10 MM

10 001 0211 



10 020 0780

STANDARD
 SPINOTTO Ø 12 MM. - PIN Ø 12 MM

10 001 0221 



Ø 10 mm - 10 015 0050

YAMAHA 4T 50 CC

YAMAHA 50: Neo's 4T 09-12
 (R.O. 5STE14001100)

STANDARD

10 001 0060 





ALBERI MOTORE
CRANKSHAFTS

SUZUKI BURGMAN 250 CC

SUZUKI 250: Burgman 03-06 • Burgman 98-02

STANDARD

10 001 0370



10 020 0702

SUZUKI BURGMAN 150 CC

SUZUKI 150: Burgman 02-06

STANDARD

10 001 0390



10 020 0702



MOTORI PIAGGIO ARIA 50 CC - AIR COOLED PIAGGIO ENGINE 50 CC

Ø 40 MM - CANNA ESTERNA 53,5 MM - EXTERNAL HOLE 53,5 MM

PIAGGIO 50: Free 92-94 • Free FL 95-02 • Liberty 97-05 • Sfera 91-93 • Sfera Rst 95-97 • Zip 92-93 • Zip Fast Raider Rst 96-97

GILERA 50: Easy Moving 95-96 • Stalker 97-04 • Storm 94-95 • Typhoon 94-97

(R.O. 487820)

10 008 0010



10 008 0011



	RICAMBI - SPARE PARTS			RICAMBI - SPARE PARTS	
				10 009 0010 - 40 mm 10 009 0014 - 40,4 mm 10 009 0018 - 40,8 mm	
		10 010 0010 - 40 mm 10 010 0014 - 40,4 mm 10 010 0018 - 40,8 mm			10 010 0011 - 40 mm 10 010 0015 - 40,4 mm
		10 068 9040			10 068 9040

MOTORI PIAGGIO ARIA 50 CC - AIR COOLED PIAGGIO ENGINE 50 CC

Ø 40 MM - CANNA ESTERNA 52 MM - EXTERNAL HOLE 52 MM

APRILIA 50: Mojito 04-08 • Scarabeo 2T Eu2 Motore Piaggio 10 • Scarabeo 2T Net 09-10 • Scarabeo Street 2T Restyling 06-09 • Sport City One 2T 08-10 • Scarabeo Street 05-06

DERBI 50: Atlantis 2T Eu2 07-09 • Atlantis 2T 10 • Bullet City 03-06 • Atlantis Two Chic 05 • Boulevard 2T 09 • Sonar 2T 09

GILERA 50: Ice 01-05 • Stalker Naked 08 • Stalker Special edition 07-08 • Stalker 97-10 • Storm Eu 2 07 • Typhoon Xr 00

PIAGGIO 50: Diesis 01 • Fly 2T 05-10 • Liberty 2T Rst 04 • Liberty 2T Sport 06-08 • Liberty 2T 06-08 • Liberty Moc 2T Elle 09-11 • Liberty Ptt Eu2 04-05 • Nrg Power Dt Serie speciale 07-08 • Nrg Power Dt 06-08 • Typhoon 2T E2 10-11 • Typhoon 01-09 • Vespa Lx 2T FL 09-10 • Vespa Lx 2T Touring 10-11 • Vespa Lx 2T 05-08 • Vespa Lxv 2T Navy 08 • Vespa Lxv 2T 06-08 • Vespa S 2T & College 07-10 • Zip 2T 08-10 • Zip 00-04

(R.O. 831116)

10 008 0250



10 008 0251



	RICAMBI - SPARE PARTS			RICAMBI - SPARE PARTS	
				10 009 0010 - 40 mm 10 009 0014 - 40,4 mm 10 009 0018 - 40,8 mm	
		10 010 0010 - 40 mm 10 010 0014 - 40,4 mm 10 010 0018 - 40,8 mm			10 010 0011 - 40 mm 10 010 0015 - 40,4 mm
		10 068 9040			10 068 9040



CILINDRI
CYLINDER KITS







MOTORI PIAGGIO LIQUIDO 50 CC <2000 - LIQUID COOLED PIAGGIO ENGINE 50 CC < 2000

GILERA 50: Runner 97-00

PIAGGIO 50: Nrg Extreme 99-00 • Nrg Rst Mc2 96-98 • Zip Sp 96-00
(R.O. 480625)

10 008 0020

10 008 0021

	RICAMBI - SPARE PARTS			RICAMBI - SPARE PARTS	
		10 009 0010 - 40 mm 10 009 0014 - 40,4 mm 10 009 0018 - 40,8 mm			10 009 0011 - 40 mm 10 009 0015 - 40,4 mm
		10 010 0010 - 40 mm 10 010 0014 - 40,4 mm 10 010 0018 - 40,8 mm			10 010 0011 - 40 mm 10 010 0015 - 40,4 mm
		10 068 9050			10 068 9050

MOTORI PIAGGIO LIQUIDO 50 CC >2000 - LIQUID COOLED PIAGGIO ENGINE 50 CC > 2000

APRILIA 50: Sr Factory 04-09 • Sr Street 03-08











DERBI 50: Gp1 01-03 • Gp1 Eu2 05-06 • Gp1 Open Eu2 06-09 • Gp1 Race Eu2 05-07

GILERA 50: Dna 05-07 • Runner Purejet 02-07 • Runner Sp 05-07

PIAGGIO 50: Nrg Mc 01-04 • Nrg Purejet 02-08 • Zip St 01-04 • Zip Sp Eu2 06-09
(R.O. 830656/833596)

10 008 0090

10 008 0091

	RICAMBI - SPARE PARTS			RICAMBI - SPARE PARTS	
		10 009 0010 - 40 mm 10 009 0014 - 40,4 mm 10 009 0018 - 40,8 mm			10 009 0011 - 40 mm 10 009 0015 - 40,4 mm
		10 010 0010 - 40 mm 10 010 0014 - 40,4 mm 10 010 0018 - 40,8 mm			10 010 0011 - 40 mm 10 010 0015 - 40,4 mm
		10 068 9070			10 068 9070



MOTORI PIAGGIO 4T 50 CC - PIAGGIO ENGINE 4T 50 CC

Ø 39 MM - MOTORI 4T - 4T ENGINE

DERBI 50: Atlantis 4T Eu2 07 • Atlantis 4T 04-06 • Boulevard 4T Eu2 09
PIAGGIO 50 4T: Fly Motore Chn 06-07 • Fly 05-07 • Fly 08-10 • Liberty Delivery Tnt 09 • Liberty Ptt 09-10 • Liberty Rst 04 • Liberty Sport 06 • Liberty Sport 07-08 • Liberty 4T 00-02 • Liberty 4T 05-08 • Liberty Moc 4T & Elle 09-10 • Vespa Et4 00-05 • Vespa Lx 4T 05-08 • Zip 4T 00-05 • Zip 4T 06-10
(R.O. 969603)

10 008 0101 

MOTORI PIAGGIO 4T 125 CC - PIAGGIO ENGINE 4T 125 CC

Ø 57 MM - MOTORI 4T - 4T ENGINE

PIAGGIO 125: Hexagon Lx4 98-99 • Liberty 98-00 • Sfera 95-97 • Vespa Et4 96-98
(R.O. 485945)

10 008 0060 

RICAMBI - SPARE PARTS	
	 10 009 0101 - 39 mm 10 009 0104 - 39,4 mm 10 009 0108 - 39,8 mm
	 10 010 0101 - 39 mm 10 010 0104 - 39,4 mm 10 010 0108 - 39,8 mm
	 10 068 9101

RICAMBI - SPARE PARTS	
	 10 009 0060 - 57 mm
	-
	-

PIAGGIO 125 4T CC - PIAGGIO 4T 125 CC

Ø 57 MM - MOTORI 4T - 4T ENGINE - GHISA - CAST IRON

PIAGGIO 125: Fly Eu3 07 • Fly 05-07 • Liberty 4T 2V Eu3 09-12 • Liberty 4T 2V ie Ptt - Ita 12 • Liberty 4T Eu3 Delivery Single 07-12 • Liberty 4T Eu3 Delivery - Tnt 08-09 • Liberty 4T Eu3 07-08 • Liberty 4T Sport Eu3 06-08 • Liberty 4T 06-07 • Liberty Rst Ptt 05-11 • Liberty Rst 04-05 • Liberty Sport 06 • Liberty 01-02 • Skipper 4T 00-02 • Typhoon 4T 2V Eu3 10-11 • Vespa Et4 99-02 • Vespa Lx 4T Eu3 Touring 10-11 • Vespa Lx 4T FL 09 • Vespa Lx Eu3 ie 09-11 • Vespa Lx Eu3 06-08 • Vespa Lx 05-06 • Vespa Lxv 4T Eu3 06-09 • Vespa Lxv 4T Navy Eu3 07-08 • Vespa Lxv ie 4T 10-13 • Vespa S 4T Eu3 07-08 • Vespa S 4T le & College 09-11 • Zip 00-02
(R.O. 831975)

10 008 0531 

LML 150 CC 2T Ø 57,8 MM - LML 150 CC 2T Ø 57,8 MM

Ø 57,8 MM - FASCE 2 MM - PISTON RINGS 2 MM
LML 150: 2T

10 008 0630 



RICAMBI - SPARE PARTS	
	 10 009 0531 - 57 mm
	 10 010 0531 - 57 mm
	-

RICAMBI - SPARE PARTS	
	 10 009 0630 - 57,8 mm 10 009 0632 - 58 mm 10 009 0634 - 58,2 mm
	-
	10 068 4110



CILINDRI CYLINDER KITS

PIAGGIO APE CAR Ø 68 MM SPINOTTO 18 MM PIAGGIO APE CAR Ø 68 MM PIN 18 MM

Ø 68 MM - SPINOTTO Ø 18 MM - PISTON PIN Ø 18 MM

PIAGGIO 220: Ape Car P2-P3 78-85 • Ape Tm P602 82-83 • Ape Tm P703-P703V 84-05
(R.O. 828864)

10 008 0180



MOTORI PIAGGIO APE MP Ø 68 MM PIAGGIO ENGINE APE MP Ø 68 MM

Ø 68 MM - SPINOTTO Ø 18 MM - PISTON PIN Ø 18 MM

PIAGGIO 220: Ape Mp P501-P601 78-96
(R.O. 243117)

10 008 0190



PIAGGIO CIAO Ø 38,2 MM SPINOTTO 10 MM PIAGGIO CIAO Ø 38,2 MM PIN 10 MM

Ø 38,2 MM - SPINOTTO Ø 10 MM - PISTON PIN Ø 10 MM

PIAGGIO 50: Ciao
(R.O. 196121)

10 008 0310



PIAGGIO VESPA PX - PE 150 CC Ø 57,8 MM PIAGGIO VESPA PX - PE 150 CC Ø 57,8 MM

Ø 57,8 MM - FASCE 2,5 MM - PISTON RINGS 2,5 MM

PIAGGIO 150: Vespa Px • Vespa Pe • Cosa
(R.O. 244172)

10 008 0370



10 008 0670





PIAGGIO VESPA SPRINT 150 CC Ø 57 MM
PIAGGIO VESPA SPRINT 150 CC Ø 57 MM

Ø 57 MM - FASCE 2,5 MM - PISTON RINGS 2,5 MM
PIAGGIO 150: Vespa Sprint
(R.O. 90628)

10 008 0410

10 008 0660



PIAGGIO VESPA PK 125 Ø 55 MM
PIAGGIO VESPA PK 125 Ø 55 MM

Ø 55 MM
PIAGGIO 125: Vespa Pk 125
(R.O. 196771)

10 008 0420

	RICAMBI - SPARE PARTS	
		Per 10 008 0410 10 009 0414 - 57,4 mm 10 009 0416 - 57,6 mm 10 009 0418 - 57,8 mm
		Per 10 008 0660 10 009 0660 - 57 mm 10 009 0664 - 57,4 mm 10 009 0666 - 57,6 mm
		10 068 4080

	RICAMBI - SPARE PARTS	
		10 009 0424 - 55,4 mm 10 009 0426 - 55,6 mm
		-
		-

PIAGGIO VESPA PE 200 Ø 66,5 MM
PIAGGIO VESPA PE 200 Ø 66,5 MM

Ø 66,5 MM
PIAGGIO 200: Vespa Pe • Cosa • Rally VSX1T - VSR1T - VSE1T
(R.O. 414708)

10 008 0430

	RICAMBI - SPARE PARTS	
		-
		10 068 4100

PIAGGIO VESPA 50 Ø 38,4 MM
PIAGGIO VESPA 50 Ø 38,4 MM

Ø 38,4 MM - 3 TRAVASI - 3 INTAKE PORTS
PIAGGIO 50: Vespa • Ape

10 008 0521

	RICAMBI - SPARE PARTS	
		10 009 0528 - 38,8 mm 10 009 0529 - 39 mm
		10 010 0521 - 38,4 mm 10 010 0528 - 38,8 mm 10 010 0529 - 39 mm
	10 068 4040	



CILINDRI
CYLINDER KITS

PIAGGIO VESPA PX 125 CC Ø 52,5 MM
PIAGGIO VESPA PX 125 CC Ø 52,5 MM

Ø 52,5 MM - FASCE 2,5 MM - PISTON RINGS 2,5 MM
PIAGGIO 125: Vespa Px
(R.O. 840087)

PIAGGIO VESPA 125 PRIMAVERA Ø 55 MM
PIAGGIO VESPA 125 PRIMAVERA Ø 55 MM

Ø 55 MM
PIAGGIO: Vespa 125 Primavera VMA2T
(R.O. 151981)



10 008 0680



FEDERAL MOGUL



10 008 0650



RICAMBI - SPARE PARTS	
	 10 009 0680 - 52,5 mm 10 009 0684 - 52,9 mm 10 009 0686 - 53,1 mm
	 -
	 10 068 4110

RICAMBI - SPARE PARTS	
	 -
	 -
	 -



MOTORI MINARELLI ORIZZONTALE 50 CC - MINARELLI HORIZONTAL ENGINE 50 CC

APRILIA 50: Gulliver 95-98 • Rally 95-03 • Scarabeo 93-05 • Sonic 98-07 • Sr 94-96

BETA 50: Ark Air 96-07 • Quadra 502 95-99

MALAGUTI 50: Centro Base 93-94 • F10 Rst Eu1-Eu2 01-03 • F12 Aria Rst Eu2 06 - (R.O. 771625000)

MBK 50: Forte 94-96 • Flipper Cat 99-00 • Fizz 94-95 • Ovetto Eu1-Eu2 97-03

SYM 50: A30-Pure

YAMAHA 50: Breeze 94-95 • Cs Jog 02 • Neo'S 02-10 • Why Eu1 99-00

10 008 0030

10 008 0031

	RICAMBI - SPARE PARTS			RICAMBI - SPARE PARTS	
				10 009 0030 - 40 mm 10 009 0034 - 40,4 mm 10 009 0038 - 40,8 mm	
		10 010 0030 - 40 mm 10 010 0034 - 40,4 mm 10 010 0038 - 40,8 mm			10 010 0031 - 40 mm 10 010 0035 - 40,4 mm
		10 068 9010			10 068 9010

MOTORI MINARELLI VERTICALE 50 CC - MINARELLI VERTICAL ENGINE 50 CC

APRILIA 50: Amico 94-98 • Amico GL-GLE 93-95 • Amico Lx • Sport-Cat 92-93

MBK 50: Booster 90-94 • Booster Road 94-95

YAMAHA 50: Bw'S Bump 97-98 • Bw'S Ng 97-98 • Bw'S Original 97-98 • Spy 95-98

(R.O. 3VLE13110000)

10 008 0040

10 008 0041

	RICAMBI - SPARE PARTS			RICAMBI - SPARE PARTS	
				10 009 0030 - 40 mm 10 009 0034 - 40,4 mm 10 009 0038 - 40,8 mm	
		10 010 0030 - 40 mm 10 010 0034 - 40,4 mm 10 010 0038 - 40,8 mm			10 010 0031 - 40 mm 10 010 0035 - 40,4 mm
		10 068 9000			10 068 9000



CILINDRI
CYLINDER KITS

MOTORI MINARELLI 50 CC LIQUIDO - MINARELLI ENGINE 50 CC L. C.

BENELLI 50: 491 Gt 98-99 • 491 Sport 98-99 • K2 LC 99-01

BETA 50: Ark Lc 96-03 • Elkon 99-03

ITALJET 50: Dragster-Formula Lc 97

MALAGUTI 50: F12 Phantom Lc Twin Disks 94-98 • F15 Fire Fox 96-98

MBK 50: Nitro 97-04 • Nitro Eu2 03

(R.O. 77113200)

10 008 0050

10 008 0051

RICAMBI - SPARE PARTS		RICAMBI - SPARE PARTS	
	 10 009 0030 - 40 mm 10 009 0034 - 40,4 mm 10 009 0038 - 40,8 mm	 BLUE LINE	 10 009 0031 - 40 mm 10 009 0035 - 40,4 mm
	 10 010 0030 - 40 mm 10 010 0034 - 40,4 mm 10 010 0038 - 40,8 mm		 10 010 0031 - 40 mm 10 010 0035 - 40,4 mm
	 10 068 9020		 10 068 9020

MOTORI MINARELLI AM6 50 CC LIQUIDO
MINARELLI ENGINE AM6 50 CC L. C.

APRILIA-BETA-YAMAHA Motori Minarelli Am6.Am345-50

Imposte guarnizioni sulla testa cilindro

Gaskets caves on cylinder head

10 008 0111

RICAMBI - SPARE PARTS	
 BLUE LINE	 10 009 0111 - 40,3 mm
	 10 010 0111 - 40,3 mm
	 10 068 9670



MOTORI KYMCO 50 CC Ø 39 MM
KYMCO ENGINE 50 CC Ø 39 MM

Ø 39 MM

KYMCO 50: Agility 4T R10 06-08 • Agility 4T R12 07-08 • Agility 4T R16 08-09 • Agility R12 05 • Filly Lx 01-02 • Filly 98-00 • Super 8 4T 09 • Super 8 07
(R.O. 00103618)



10 008 0381 

MOTORI KYMCO 125 CC Ø 52,4 MM
KYMCO ENGINE 125 CC Ø 52,4 MM

Ø 52,4 MM

KYMCO 125: Agility 4T Eu 3 06-08 • Agility 4T 06 • Agility Carry 11 • Agility R16 08-12 • Agility Rs 09 • Like Lx 12 • Like 09 • People Eu 3 11 • Super 8 08-09
(R.O. 00123115)

10 008 0391 

	RICAMBI - SPARE PARTS	
		10 009 0381 - 39 mm
		-
	10 068 0381	

	RICAMBI - SPARE PARTS	
		10 009 0391 - 52,4 mm
		-
	10 068 0391	

MOTORI KYMCO 150 CC Ø 57,4 MM
KYMCO ENGINE 150 CC Ø 57,4 MM

Ø 57,4 MM

KYMCO 150: Agility R16 08-09
(R.O. 00112042)

10 008 0401 

MOTORI KYMCO 250 CC Ø 72,7 MM LIQUIDO
KYMCO ENGINE 250 CC Ø 72,7 MM L. C.

Ø 72,7 MM

KYMCO 250: B&W 00 • B&W Eu2 03 • Grand Dink 01-02 • Grand Dink Eu2 03-04 • Kxr 03-04 • Mxu 05 • People Lc 03-04 • Yup 03

10 008 0160 

	RICAMBI - SPARE PARTS	
		Per 10 008 0401 10 009 0401 - 57,4 mm
		-
	10 068 0401	

	RICAMBI - SPARE PARTS	
		10 009 0160 - 72,7 mm
		10 010 0160 - 72,7 mm
	10 068 9310	



CILINDRI CYLINDER KITS

MOTORI KYMCO 50 CC 2T ARIA KYMCO ENGINE 50 CC 2T AIR COOLED

Ø 39 MM

KYMCO 50: Agility 2T R16 10-12 • Agility Rs Naked 2T 10 • Dink Classic Eu2 03 • Dink Lc 98-02 • Like 2T 09 • People Eu2 03-11 • People S 05-08 • People 99-04 • Super 8 2T 09 • Top Boy 97-00 • Vitality 2T 04 • Yup Eu2 03 • Yup 02 (R.O. 00102511)

10 008 0461



Ø Canna esterna 51 mm
External hole 51 mm

10 008 0551



Ø Canna esterna 49 mm
External hole 49 mm



KEEWAY 50 CC 2T ARIA KEEWAY 50 CC 2T AIR COOLED

Ø 40 MM

KEEWAY 50: Atv Ec2 06 • F-Act Evo 09 • F-Act 07-08 • Flash07-08 • Focus 06 • Hurricane 06-07 • Matrix 06-08 • Ry6 10 • Ry8 Sport 07-10 • Ry808 (R.O. 204200041000)

10 008 0471



Scarico circolare
Round exhaust

10 008 0581



Scarico ovale
Oval exhaust



MOTORI PEUGEOT 50 CC 2T PEUGEOT ENGINE 50 CC 2T

Ø 40 MM

PEUGEOT 50: Buxy 94-97 • Elyseo 99 • Looxor 01-03 • Metal-X 02 • Speedake 95-97 • Speedfight 2 Aria 05-06 • Vivacity Vsx-Xr 02-04

10 008 0070

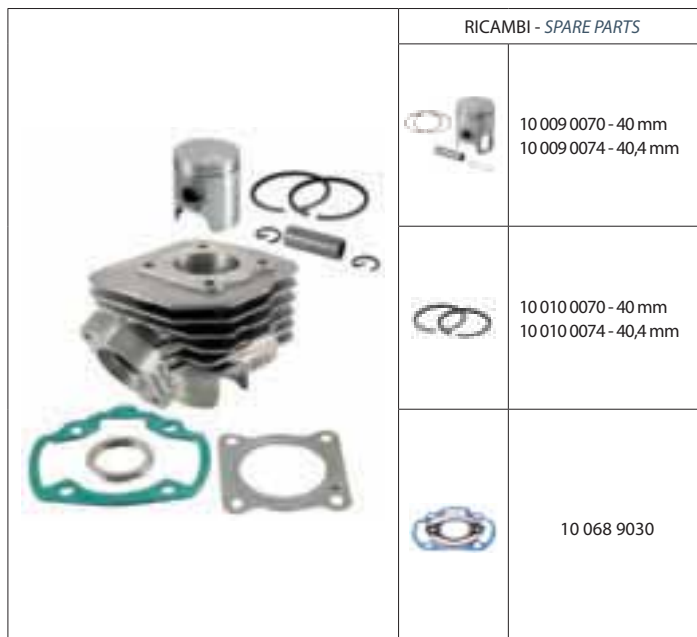

MOTORI PEUGEOT LIQUIDO 50 CC 2T PEUGEOT ENGINE 50 CC L. C.

Ø 40 MM

PEUGEOT 50: Speedfight Acqua 97-98 • X-Fight 00 (R.O. 753038)

10 008 0201





MOTORI YAMAHA 125 CC Ø 52 MM
YAMAHA ENGINE 125 CC Ø 52 MM

Ø 52 MM

YAMAHA 125: Vp X-City 08-10 • Yp R X-Max Abs 11 - Yp R X • Max 08-11 • Yzf - R 08-11

10 008 0341



MOTORI YAMAHA 125 CC Ø 53,7 MM
YAMAHA ENGINE 125 CC Ø 53,7 MM

Ø 53,7 MM

YAMAHA 125: Xn Teo's 00 • Xq Maxter 01-02 • Yp E Majesty 03-09 • Yp majesty 98-02

10 008 0350



	RICAMBI - SPARE PARTS	
		10 009 0341 - 52 mm
		-
		-

	RICAMBI - SPARE PARTS	
		-
		-
		10 068 9140

MOTORI YAMAHA 250 CC Ø 69 MM
YAMAHA ENGINE 250 CC Ø 69 MM

Ø 69 MM

APRILIA 250: Leonardo 99-01 • Leonardo St 01
BENELLI 250: Velvet 99-01 • Velvet Touring 02-03
MALAGUTI 250: Madison S 99-01
MBK 250: Yp Skyliner 00-03
YAMAHA 250: Majesty 96-03

10 008 0170



	RICAMBI - SPARE PARTS	
		-
		10 068 9160



CILINDRI
CYLINDER KITS

MOTORI HONDA 150 CC Ø 57,5 MM LIQUIDO
HONDA ENGINE 150 CC Ø 57,5 L. C.

Ø 57,5 MM

HONDA 150: Sh 150 01-08 • Nes 4T • Ps 4T • Pantheon 4T

KEEWAY 150: Outlook 07-08

10 008 0440



RICAMBI - SPARE PARTS	
	10 009 0440 - 57,5 mm
	10 010 0440 - 57,5 mm
	10 068 9090 10 068 0440

MOTORI HONDA 125 CC Ø 52,4 MM LIQUIDO
HONDA ENGINE 125 CC Ø 52,4 L. C.

Ø 52,4 MM

HONDA 125: Sh

10 008 0450



RICAMBI - SPARE PARTS	
	10 009 0450 - 52,4 mm
	10 010 0450 - 52,4 mm
	10 068 9080 10 068 0450

MOTORI HONDA 50 CC 2T ARIA
HONDA ENGINE 50 CC 2T AIR COOLED

Ø 39 MM

HONDA 50: Sfx V 95 • Sh 91-96 • Sj Bali 93 • Sky 97 • Sxr 95

10 008 0080



RICAMBI - SPARE PARTS	
	10 009 0080 - 39 mm 10 009 0084 - 39,4 mm 10 009 0088 - 39,8 mm
	10 010 0080 - 39 mm 10 010 0084 - 39,4 mm 10 010 0088 - 39,8 mm
	10 068 9060



MOTORI MINARELLI ORIZZONTALE
MINARELLI HORIZONTAL ENGINE

Ø 47 MM

APRILIA 50: Gulliver 95-98 • Rally 95-03 • Scarabeo 93-05
• Sonic 98-07 • Sr 94-96

MALAGUTI 50: Centro Base 93-94 • F10 Rst Eu1-Eu2 01-03
• F12 Aria Rst Eu2 06

MBK 50: Forte 94-96 • Flipper Cat 99-00 • Fizz 94-95 • Ovetto Eu1-Eu2 97-03

10 008 0490 

	RICAMBI - SPARE PARTS	
		10 009 0550 - 47 mm
		10 010 0550 - 47 mm
		10 068 9730

MOTORI MINARELLI VERTICALE
MINARELLI VERTICAL ENGINE

Ø 47 MM

APRILIA 50: Amico 94-98 • Amico GL-GLE 93-95 • Amico Lx
• Sport-Cat 92-93

MBK 50: Booster 90-94 • Booster Road 94-95

YAMAHA 50: Bw'S Bump 97-98 • Bw'S Ng 97-98 • Bw'S Original 97-98
• Spy 95-98

10 008 0500 

	RICAMBI - SPARE PARTS	
		10 009 0550 - 47 mm
		10 010 0550 - 47 mm
		10 068 9740

MOTORI MINARELLI LIQUIDO
MINARELLI ENGINE L. C.

Ø 47 MM

APRILIA 50: Sr Liquid Cooled 94-96 • Sr Stealth - Racing 97-99 •
Sonic Gp 98-08 • Rally Liquid Cooled 96-99 • Gulliver Lc 96-98

BENELLI 50: 491 Gt 98-99 • 491 Sport 98-99 • K2 Lc 99-01

BETA 50: Ark Lc 96-03 • Elkon 99-03

ITALJET 50: Dragster-Formula Lc 97

MALAGUTI 50: F12 Phantom Lc-Twin Disks 94-98

• F15 Fire Fox 96-98

MBK 50: Nitro 97-04 • Nitro Eu2 03

YAMAHA 50: Aerox 97-07 • Aerox Eu2 03





10 008 0510 

	RICAMBI - SPARE PARTS	
		10 009 0550 - 47 mm
		10 010 0550 - 47 mm
		10 068 9750

PIAGGIO CIAO Ø 43 MM SPINOTTO 10 MM
PIAGGIO CIAO Ø 43 MM PIN 10 MM

Ø 43 MM - SPINOTTO Ø 10 MM - PISTON PIN Ø 10 MM
PIAGGIO 50: Ciao

10 008 0690  

	RICAMBI - SPARE PARTS	
		-
		-
		-

MOTORI PIAGGIO ARIA
AIR COOLED PIAGGIO ENGINE

Ø 47 MM - CANNA ESTERNA 53,5 MM - EXTERNAL HOLE Ø 53,5 MM

DERBI - GILERA 50: Free 92-94 • Free FL 95-02 • Liberty 97-05
• Sfera 91-93 • Sfera Rst 95-97 • Zip 92-93 • Zip Fast Raider Rst 96-97
PIAGGIO 50: Free 92-94 • Free FL 95-02 • Liberty 97-05
• Sfera 91-93 • Sfera Rst 95-97 • Zip 92-93 • Zip Fast Raider Rst 96-97

10 008 0480



	RICAMBI - SPARE PARTS	
		10 009 0560 - 47 mm
		10 010 0560 - 47 mm
		10 068 9720

MOTORI PIAGGIO ARIA
AIR COOLED PIAGGIO ENGINE

Ø 47 MM - CANNA ESTERNA 52 MM - EXTERNAL HOLE Ø 52 MM

PIAGGIO 50: Diesis 01 • Fly 2T 05-10 • Liberty 2T Rst 04 • Liberty 2T Sport 06-08 • Liberty 2T 06-08 • Liberty Moc 2T Elle 09-11 • Liberty Ptt Eu2 04-05 • Nrg Power Dt Serie speciale 07-08 • Nrg Power Dt 06-08 • Typhoon 2T E2 10-11 • Typhoon 01-09 • Vespa Lx 2T FL 09-10 • Vespa Lx 2T Touring 10-11 • Vespa Lx 2T 05-08 • Vespa Lxv 2T Navy 08 • Vespa Lxv 2T 06-08 • Vespa S 2T & College 07-10 • Zip 2T 08-10 • Zip 00-04

10 008 0610



	RICAMBI - SPARE PARTS	
		10 009 0580 - 47 mm
		10 010 0550 - 47 mm
		10 068 9840

MOTORI PIAGGIO LIQUIDO <2000
PIAGGIO ENGINE L. C. <2000

Ø 47 MM

GILERA 50: Runner 97-00
PIAGGIO 50: Nrg Extreme 99-00 • Nrg Rst Mc2 96-98 • Zip Sp 96-00

10 008 0560



	RICAMBI - SPARE PARTS	
		10 009 0560 - 47 mm
		10 010 0550 - 47 mm
		10 068 9760

MOTORI PIAGGIO LIQUIDO >2000
PIAGGIO ENGINE L. C. >2000

Ø 47 MM

APRILIA 50: Sr Factory 04-09 • Sr Street 03-08
DERBI 50: Gp1 01-03 • Gp1 Eu2 05-06 • Gp1 Open Eu2 06-09 • Gp1 Race Eu2 05-07
GILERA 50: Dna 05-07 • Runner Purejet 02-07 • Runner Sp 05-07
PIAGGIO 50: Nrg Mc3 01-04 • Nrg Power Purejet 04-08
Nrg Purejet 02-04 • Zip Sp 01-04 • Zip Sp Eu2 06-09

10 008 0570



	RICAMBI - SPARE PARTS	
		10 009 0570 - 47 mm
		10 010 0570 - 47 mm
		10 068 9770



MOTORI PIAGGIO VESPA APE - PIAGGIO ENGINE VESPA APE

10 008 0281  Ø 47 mm - 3 Travasi - 3 intake ports

10 008 0271  Ø 50 mm - 3 Travasi - 3 intake ports

10 008 0141  Ø 55 mm - 6 Travasi - 6 intake ports

	RICAMBI - SPARE PARTS - Ø 47		RICAMBI - SPARE PARTS - Ø 50		RICAMBI - SPARE PARTS - Ø 55	
		10 009 0280 - 47 mm 10 009 0284 - 47,4 mm 10 009 0288 - 47,8 mm		10 009 0271 - 50 mm 10 009 0274 - 50,4 mm 10 009 0278 - 50,8 mm		10 009 0141 - 55 mm 10 009 0144 - 55,4 mm 10 009 0148 - 55,8 mm
	10 010 0280 - 47 mm 10 010 0284 - 47,4 mm 10 010 0288 - 47,8 mm		10 010 0271 - 50 mm 10 010 0274 - 50,4 mm 10 010 0278 - 50,8 mm		10 010 0141 - 55 mm 10 010 0144 - 55,4 mm 10 010 0148 - 55,8 mm	
	-		-		-	



**MOTORI KYMCO 4T
KYMCO ENGINE 4T**

Ø 47 MM - FORNITO SENZA TESTA CILINDRO - NO CYLINDER HEAD
KYMCO 50: Agility 4T R10 06-08 • Agility 4T R12 07-08 • Agility 4T R16 08-09 • Agility R12 05 • Filly Lx 01-02 • Filly 98-00 • Super 8 4T 09 • Super 8 07



**YAMAHA 150 CC Ø 60,5 MM
YAMAHA ENGINE 150 CC Ø 60,5 MM**

Ø 60.5 MM - FORNITO SENZA TESTA CILINDRO - NO CYLINDER HEAD
YAMAHA 125: Yp X-City 08-10 • Yp R X-Max Abs 11 • Yp R X • Max 08-11 • Yzf - R 08-11

10 008 0540 

	RICAMBI - SPARE PARTS	
		10 009 0540 - 47 mm
	10 010 0540 - 47 mm	
	-	

10 008 0621 

	RICAMBI - SPARE PARTS	
		-
	-	
	-	



TESTE MOTORE - TIPO ORIGINALE
CYLINDER HEAD - ORIGINAL TYPE

10 007 0021 

PER CILINDRO PIAGGIO RAFF. LIQUIDO MOD. <00
FOR CYLINDER PIAGGIO LIQUID COOLED <00
GILERA 50: Runner 97/98
PIAGGIO 50: Nrg • Nrg Rst Mc2 • Ntt • Quartz



10 007 0081 

PER CILINDRO PIAGGIO RAFF. LIQUIDO MOD. >00
FOR CYLINDER PIAGGIO LIQUID COOLED >00
APRILIA: Sr Fun master Street 03 • Sr R 04
GILERA: Dna • Gp Experience 03-06
Runner Poggiali • Sp-Sp Race 02-06
PIAGGIO: Nrg Mc3 01-04 • Purejet 02-04
Nrg Power DD 05-06 • Zip Sp 01-04
(R.O. 830656-833598)



10 007 0060 

PER CILINDRO PEUGEOT ARIA
FOR CYLINDER PEUGEOT AIR COOLED
50: Elyseo 99 • SV Geo 91-95 • Zenith L 94-96 •
Zenith N 97-98 • Zenith LN • LS 97-98 • Spee-
dake 95-97 • Speedfight 97-98 • Squab 95-97
• Trekker 98 • Buxy 94-97



10 007 0010 

PER CILINDRO PIAGGIO RAFF. ARIA
FOR CYLINDER PIAGGIO AIR COOLED
GILERA: Stalker 97-98 • Storm 94-95
Easy Moving 95-96 • Typhoon 94-97
PIAGGIO: Free 92-94 • Free FL 95-98
Sfera Rst 95-97 • Sfera Maquillage-Liberty
97-98 • Vespa Et2 97-98 • Zip & Zip Bimodale
94-97 • Zip Base 92-96 • Zip Fast Raider 93-97
• Zip Rst 96-98 - (R.O. 286534)



10 007 0020 

PER CILINDRO PIAGGIO RAFF. LIQUIDO MOD. <00
FOR CYLINDER PIAGGIO LIQUID COOLED <00
GILERA: Runner 97-98
PIAGGIO: Quartz 92-96 • Ntt 95-96 • Nrg 94-96
Nrg Rst Mc2 96-98 • ZIP SP 96-97
(R.O. 289513)



10 007 0030 

PER CILINDRI MINARELLI ORIZZONTALE
FOR CYLINDER MINARELLI HORIZONTAL
MINARELLI - MBK - YAMAHA
(R.O. 77701400)



10 007 0040 

PER CILINDRI MINARELLI VERTICALE
FOR CYLINDER MINARELLI VERTICAL
APRILIA - MBK - YAMAHA
(R.O. 3VLE 11110000)



10 007 0050 

PER CILINDRI MINARELLI LIQUIDO
FOR CYLINDER MINARELLI LIQUID COOLED
MINARELLI - MBK - YAMAHA
(R.O. 77701600)



10 007 0120 

















































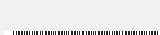
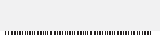

PER CILINDRI PIAGGIO CIAO Ø 38,2
FOR CYLINDER PIAGGIO CIAO Ø 38,2
(R.O. 124533)



PISTONI COMPLETI E FASCE PER CILINDRI RMS

PISTONS AND PISTON RINGS FOR RMS CYLINDERS

























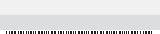
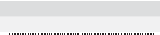

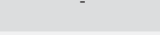

							
		PISTONI COMPLETI PER CILINDRI RMS <i>PISTONS FOR RMS CYLINDERS</i>			KIT FASCE ELASTICHE PER PISTONI RMS <i>PISTON RINGS FOR RMS PISTONS</i>		
APPLICAZIONI - APPLICATIONS	CC.	Ø PISTONE MM Ø PISTON MM	CODICE RMS RMS CODE	CODICE A BARRE BARCODE	Ø FASCE ELASTICHE MM Ø PISTON RINGS MM	CODICE RMS RMS CODE	CODICE A BARRE BARCODE
Aprilia - Beta - Malaguti - Mbk - Sym Minarelli Orizzontale - (Per For 10 008 0031)	50	40	10 009 0031		40 x 1,2	10 010 0031	
	50	40,4	10 009 0035		40,4 x 1,2	10 010 0035	
Minarelli - MBK - Yamaha (Raffr. Aria e Liquido) Minarelli - MBK - Yamaha (Liquid and air cooled)	50	40	10 009 0030		40 x 1,5	10 010 0030	
		40,4	10 009 0034		40,4 x 1,5	10 010 0034	
		40,8	10 009 0038		40,8 x 1,5	10 010 0038	
Minarelli - MBK - Yamaha (Verticale) Minarelli - MBK - Yamaha (Vertical)	50	40	-	-	40 x 1,2	10 010 0040	
		40,4	-	-	40,4 x 1,2	10 010 0044	
		40,8	-	-	40,8 x 1,2	10 010 0048	
Minarelli - AM6 - Aprilia - Beta HM - Peugeot - Yamaha	50	40,3	10 009 0111		40,3 x 1,2	10 010 0111	
Piaggio - Gilera - (Per For 10 008 0011)	50	40	10 009 0011		40 x 1,2	10 010 0011	
	50	40,4	10 009 0015		40,4 x 1,2	10 010 0015	
Piaggio - Gilera	50	40	10 009 0010		40 x 1,5	10 010 0010	
		40,4	10 009 0014		40,4 x 1,5	10 010 0014	
		40,8	10 009 0018		40,8 x 1,5	10 010 0018	
Piaggio Ciao spinotto Ø 10 mm - Pin Ø 10 mm	50	38,4	10 009 0314		38,4	10 010 0314	
		38,6	10 009 0316		38,6	10 010 0316	
		38,8	10 009 0318		38,8	10 010 0318	
Piaggio 4T	50	39	10 009 0101		39	10 010 0101	
		39,4	10 009 0104		39,4	10 010 0104	
		39,8	10 009 0108		39,8	10 010 0108	
Piaggio - Vespa	50	38,4	10 009 0521		38,4	10 010 0521	
		38,8	10 009 0528		38,8	10 010 0528	
		39	10 009 0529		39	10 010 0529	
Honda Sh	50	39	10 009 0080		39 x 1,5 39 x 1,2	10 010 0080	
		39,4	10 009 0084		39,4 x 1,5 39,4 x 1,2	10 010 0084	
		39,8	10 009 0088		39,8 x 1,5 39,8 x 1,2	10 010 0088	
Keeway	50	40	10 009 0471		40	10 010 0471	



PISTONI COMPLETI E FASCE PER CILINDRI RMS



























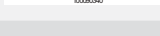



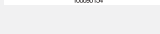
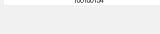



PISTONS AND PISTON RINGS FOR RMS CYLINDERS

							
		PISTONI COMPLETI PER CILINDRI RMS <i>PISTONS FOR RMS CYLINDERS</i>			KIT FASCE ELASTICHE PER PISTONI RMS <i>PISTON RINGS FOR RMS PISTONS</i>		
APPLICAZIONI - APPLICATIONS	CC.	Ø PISTONE MM Ø PISTON MM	CODICE RMS RMS CODE	CODICE A BARRE BARCODE	Ø FASCE ELASTICHE MM Ø PISTON RINGS MM	CODICE RMS RMS CODE	CODICE A BARRE BARCODE
Kymco 2T	50	39	10 009 0461		39	10 010 0461	
Kymco 50 4T - (Per For 10 008 0380)	50	39	10 009 0380		39	10 010 0380	
Kymco 50 4T - (Per For 10 008 0381)	50	39	10 009 0381		-	-	-
Peugeot (Raffr. Aria) Peugeot (Air cooled)	50	40	10 009 0070		40 x 1,5	10 010 0070	
		40,4	10 009 0074		40,4 x 1,5	10 010 0074	
Peugeot (Raffr. Acqua) Peugeot (Liquid cooled)	50	40	10 009 0201		40	10 010 0201	
Aprilia - Beta - Malaguti - MbK - Sym Minarelli Orizzontale - (Per For 10 008 0490)	75	47	10 009 0550		47 x 1,2	10 010 0550	
Aprilia - MbK - Yamaha Minarelli Verticale - (Per For 10 008 0500)	75	47	10 009 0550		47 x 1,2	10 010 0550	
Aprilia - Benelli - Beta - Italjet - Malaguti MbK - Yamaha Minarelli Lc - (Per For 10 008 0510)	75	47	10 009 0550		47 x 1,2	10 010 0550	
Minarelli - MBK - Yamaha (Per For 10 008 0210) (Per For 10 008 0220) (Per For 10 008 0230)	75	-	-	-	47,4 x 1,2	10 010 0214	
		-	-	-	47,8 x 1,2	10 010 0218	
Aprilia - Derbi - Gilera - Piaggio (Per For 10 008 0570)	75	47	10 009 0570		47 x 1,5	10 010 0570	
Derbi - Gilera - Piaggio (Per For 10 008 0480 - 10 008 0560)	75	47	10 009 0560		47 x 1,2	10 010 0550	
Gilera - Piaggio Lc (Per For 10 008 0560)	75	47	10 009 0560		47 x 1,2	10 010 0550	
Piaggio 2T (Per For 10 008 0610)	75	47	10 009 0580		47 x 1,2	10 010 0550	
Piaggio - Gilera (Per For 10 008 0240) (Per For 10 008 0320) (Per For 10 008 0330)	75	-	-	-	47,4 x 1,2	10 010 0214	
		-	-	-	47,8 x 1,2	10 010 0218	
Piaggio Vespa Ape	75	47	10 009 0280		47 x 1,5	10 010 0280	
		47,4	10 009 0284		47,4 x 1,5	10 010 0284	
		47,8	10 009 0288		47,8 x 1,5	10 010 0288	
Piaggio Vespa Ape	85	50	10 009 0271		50 x 1,5	10 010 0271	
		50,4	10 009 0274		50,4 x 1,5	10 010 0274	
		50,8	10 009 0278		50,8 x 1,5	10 010 0278	
Piaggio-Vespa-Ape	100	55	10 009 0141		55 x 1,5	10 010 0141	
		55,4	10 009 0144		55,4 x 1,5	10 010 0144	
		55,8	10 009 0148		55,8 x 1,5	10 010 0148	

PISTONI COMPLETI E FASCE PER CILINDRI RMS

PISTONS AND PISTON RINGS FOR RMS CYLINDERS



























		 PISTONI COMPLETI PER CILINDRI RMS <i>PISTONS FOR RMS CYLINDERS</i>			 KIT FASCE ELASTICHE PER PISTONI RMS <i>PISTON RINGS FOR RMS PISTONS</i>		
APPLICAZIONI - APPLICATIONS	CC.	Ø PISTONE MM Ø PISTON MM	CODICE RMS RMS CODE	CODICE A BARRE BARCODE	Ø FASCE ELASTICHE MM Ø PISTON RINGS MM	CODICE RMS RMS CODE	CODICE A BARRE BARCODE
Piaggio: Liberty-Sfera-Vespa ET4 4T- (Per For 10 008 0060)	125	57	10 009 0060		-	-	-
Piaggio: Liberty-Vespa Lx- (Per For 10 008 0531)	125	57	10 009 0531		57	10 010 0531	
Piaggio Vespa Pk 125	125	55,4	10 009 0424		-	-	-
		55,6	10 009 0426		-	-	-
Piaggio Vespa Px (Per For 10 008 0680) Fasce 2,5 mm - 2,5 mm Piston rings 	125	52,5	10 009 0680		-	-	-
		52,9	10 009 0684		-	-	-
		53,1	10 009 0686		-	-	-
Honda Sh 125 - (Per For 10 008 0450)	125	52,4	10 009 0450		52,4	10 010 0450	
Kymco 125 - (Per For 10 008 0390)	125	52,4	10 009 0390		52,4	10 010 0390	
Kymco 125 - (Per For 10 008 0391)	125	52,4	10 009 0391		-	-	-
Yamaha 125 - (Per For 10 008 0340)	125	52	10 009 0340		-	-	-
Yamaha 125 - (Per For 10 008 0341)	125	52	10 009 0341		-	-	-
Honda Sh 150 - (Per For 10 008 0150)	150	58	10 009 0150		-	-	-
		58,4	10 009 0154		58,4	10 010 0154	
		58,8	10 009 0158		58,8	10 010 0158	
Honda Sh 150 - (Per For 10 008 0440)	150	57,5	10 009 0440		57,5	10 010 0440	
Kymco 150 - (Per For 10 008 0401)	150	57,4	10 009 0401		-	-	-
LML 150 cc 2T (Per For 10 008 0630) Fasce 2 mm - 2 mm Piston rings 	150	57,8	10 009 0630		-	-	-
		58	10 009 0632		-	-	-
		58,2	10 009 0634		-	-	-
Piaggio Vespa Px - Sprint	150	57,4	10 009 0414		-	-	-
		57,6	10 009 0416		-	-	-
		57,8	10 009 0418		-	-	-
Piaggio Vespa Px - Pe (Per For 10 008 0670) Fasce 2,5 mm - 2,5 mm Piston rings 	150	57,8	10 009 0670		-	-	-
		58,4	10 009 0676		-	-	-
		58,6	10 009 0678		-	-	-



PISTONI COMPLETI E FASCE PER CILINDRI RMS

PISTONS AND PISTON RINGS FOR RMS CYLINDERS

							
		PISTONI COMPLETI PER CILINDRI RMS <i>PISTONS FOR RMS CYLINDERS</i>			KIT FASCE ELASTICHE PER PISTONI RMS <i>PISTON RINGS FOR RMS PISTONS</i>		
APPLICAZIONI - APPLICATIONS	CC.	Ø PISTONE MM Ø PISTON MM	CODICE RMS RMS CODE	CODICE A BARRE BARCODE	Ø FASCE ELASTICHE MM Ø PISTON RINGS MM	CODICE RMS RMS CODE	CODICE A BARRE BARCODE
Piaggio Vespa Sprint (Per For 10 008 0660) Fasce 2,5 mm - 2,5 mm Piston rings 	150	57	10 009 0660		-	-	-
		57,4	10 009 0664		-	-	-
		57,6	10 009 0666		-	-	-
Piaggio Ape - Spinotto Ø 18 mm - Pin Ø 18 mm	220	68	10 009 0180		68 x 2,5	10 010 0180	
		-	-	-	68,4 x 2,5	10 010 0184	
		68,6	10 009 0186		68,6 x 2,5	10 010 0186	
		68,8	10 009 0188		68,8 x 2,5	10 010 0188	
Piaggio Ape - Spinotto Ø 16 mm - Pin Ø 16 mm	220	68	10 009 0360		68 x 2,5	10 010 0180	
		68,4	10 009 0364		68,4 x 2,5	10 010 0184	
		68,6	10 009 0366		68,6 x 2,5	10 010 0186	
		68,8	10 009 0368		68,8 x 2,5	10 010 0188	
Kymco Dink 250	250	72,7	10 009 0160		72,7	10 010 0160	
Yamaha Majesty 250	250	69,5	10 009 0175		69,5	10 010 0175	



Le catene di distribuzione **KMC** sono prodotte in modo accurato grazie all'utilizzo di materiale di alta qualità, a metodi di stampaggio avanzati ed a speciali trattamenti termici delle piastre. Queste procedure ottimizzano l'area di contatto tra le piastre della catena e le ruote dentate, aumenta la resistenza a fatica della catena assicurando una diminuzione del rumore di funzionamento. Queste qualità rendono le catene di distribuzione **KMC** una buona alternativa al ricambio originale per qualità, durata e prezzo.

KMC timing chains are precisely fabricated with an high grade alloy material, with advanced stamping method and exclusive heat-treatment for link plates. It maximize contact area between links and sprocket for a better chain strength, impact resistance and low running noise. These properties make KMC timing chains a good option of OEM timing chains in terms of quality, like and price.

16 371 2010



16 371 9180

MODELLO - MODEL
2023LN

GIUNTO CATENA - CONNECTING LINK

KYMCO 50 • (R.O. 00103612) • SYM 50 • (R.O. 1C14401BE2A00) • YAMAHA 50 • (R.O. 5STE21900000)

16 371 2020



16 371 9180

MODELLO - MODEL
2023LN

GIUNTO CATENA - CONNECTING LINK

APRILIA 50-100 • PIAGGIO 50-100 • (R.O. 96933R)

16 371 2030



16 371 9180

MODELLO - MODEL
2023LN

GIUNTO CATENA - CONNECTING LINK

APRILIA 125 • HONDA 125-150 • (R.O. 14401-KCW-851) • KYMCO 125-150-200 • (R.O. 00123110 • 00114099)
PIAGGIO 125-150-200 • (R.O. 82643R) • SYM 125-150-200 • (R.O. 1C14401M92000)

16 371 2040



16 371 9180

MODELLO - MODEL
2023LN

GIUNTO CATENA - CONNECTING LINK

HONDA 110 • (R.O. 14401 • GFM-971) • SYM 125 • (R.O. 1C14401V02000)

16 371 2050 

MODELLO - MODEL
2023LN



16 371 9180 

GIUNTO CATENA - CONNECTING LINK

HONDA 125-150 • (R.O. 14401-KSS-931) • SYM 125-150 • (R.O. 1C14401F6A000)

16 371 2060 

MODELLO - MODEL
2034LW



16 371 9210 

GIUNTO CATENA - CONNECTING LINK

SUZUKI 125-150 • (R.O. 12760-055A0-000)

16 371 2070 

MODELLO - MODEL
2023LN



16 371 9180 

GIUNTO CATENA - CONNECTING LINK

APRILIA 125 • (R.O. 82644R) • GILERA 125-200 • (R.O. 82644R) • PIAGGIO 125-150-200 • (R.O. 82644R)
• MALAGUTI 125-150-200 • (R.O. 51700400) • YAMAHA 125-150 • (R.O. 94568A809600 • 1C14401A1A000)

16 371 2080 

MODELLO - MODEL
2023LN



16 371 9180 

GIUNTO CATENA - CONNECTING LINK

KYMCO 250 • (R.O. 00123910)

16 371 2090 

MODELLO - MODEL
2023LW



16 371 9190 

GIUNTO CATENA - CONNECTING LINK

SUZUKI 125-150-200 • (R.O. 12760-04B00-000)

16 371 2100 

MODELLO - MODEL
2034LN



16 371 9200 

GIUNTO CATENA - CONNECTING LINK

APRILIA 400-500 • (R.O. 827889) • GILERA 500 • (R.O. 827889) • PIAGGIO 400-500 • (R.O. 827889) • MALAGUTI 500 • (R.O. 41701000)

16 371 2110 

MODELLO - MODEL
2034LN



16 371 9200 

GIUNTO CATENA - CONNECTING LINK

YAMAHA 500 • (R.O. 945821813200)

16 371 2120 

MODELLO - MODEL
2034LN



16 371 9200 

GIUNTO CATENA - CONNECTING LINK

YAMAHA 400 • (R.O. 945821813600)

16 371 2130 

MODELLO - MODEL
2023LW



16 371 9210 

GIUNTO CATENA - CONNECTING LINK

KYMGCO 125-150-200 • (R.O. 00123912) • MBK 125-150 • (R.O. 945914809400) • YAMAHA 125-150-180 • (R.O. 945914809400)
MALAGUTI 125-150 • (R.O. 71700800)

16 371 2140 

MODELLO - MODEL
2023LW



16 371 9190 

GIUNTO CATENA - CONNECTING LINK

APRILIA 125.150 • (R.O. AP0297932)

16 371 2150 

MODELLO - MODEL
2034LW



16 371 9210 

GIUNTO CATENA - CONNECTING LINK

SUZUKI 250-400 • (R.O. 12760-19B71-000)

16 371 2160 

MODELLO - MODEL
2034LW



16 371 9210 

GIUNTO CATENA - CONNECTING LINK

SUZUKI 400-650 • (R.O. 12760-19F01-000)

16 371 2170 

MODELLO - MODEL
2034LN



16 371 9200 

GIUNTO CATENA - CONNECTING LINK

HONDA 400-600 • (R.O. 14401-MCT-003)

16 371 2180 

MODELLO - MODEL
2023LW



16 371 9190 

GIUNTO CATENA - CONNECTING LINK

APRILIA 250 • (R.O. AP8122434) • MALAGUTI 250 • (R.O. 91700100) • MBK 250-300 • (R.O. 945821710400)
• YAMAHA 250- 300 • (R.O. 945821710400)

16 371 2190 

MODELLO - MODEL
2023LN



16 371 9180 

GIUNTO CATENA - CONNECTING LINK

HONDA 300 • (R.O. 14401-KFB-751)

16 371 2200 

MODELLO - MODEL
2023LN



16 371 9180 

GIUNTO CATENA - CONNECTING LINK

APRILIA 125-300 • DERBI 125-250-300 Rambla • GILERA 250-300 • PIAGGIO 250-300 • (R.O. 82723R)

16 371 2210 

MODELLO - MODEL
2023LN



16 371 9180 

GIUNTO CATENA - CONNECTING LINK

PEUGEOT 50 • (R.O. 801526) • SYM 50 • (R.O. 1C14401A1A000)

16 371 2240 

MODELLO - MODEL
2023LN



16 371 9180 

GIUNTO CATENA - CONNECTING LINK

PIAGGIO 125 • (R.O. 436246)

16 371 2250 

MODELLO - MODEL
2023LN



16 371 9180 

GIUNTO CATENA - CONNECTING LINK

SYM 50-100 • (R.O. 1C14401A31000)

16 371 2260 

MODELLO - MODEL
2034LN



16 371 9200 

GIUNTO CATENA - CONNECTING LINK

SYM 250-300 • (R.O. 1C14401RFA000)

16 371 2270 

MODELLO - MODEL
2034LN



16 371 9200 

GIUNTO CATENA - CONNECTING LINK

KYMCO 200-300-400 • (R.O. 00114051) • SYM 400 • (R.O. 1C14401L4A000)

16 371 2280 

MODELLO - MODEL
2023LN



16 371 9180 

GIUNTO CATENA - CONNECTING LINK

PIAGGIO 350 • (R.O. 82992R)

16 371 2290 

MODELLO - MODEL
2034LN



16 371 9200 

GIUNTO CATENA - CONNECTING LINK

KYMCO 500 • (R.O. 00123058)

16 371 2310 

MODELLO - MODEL
2034LN



16 371 9200 

GIUNTO CATENA - CONNECTING LINK

YAMAHA 530 • (R.O. 945915313400)

CODICE RMS <i>RMS CODE</i>	MODELLO <i>MODEL</i>	CC.	ANNI <i>YEARS</i>	RIF. ORIGINALE <i>OEM NUMBER</i>	CODICE RMS <i>RMS CODE</i>	MODELLO <i>MODEL</i>	CC.	ANNI <i>YEARS</i>	RIF. ORIGINALE <i>OEM NUMBER</i>
APRILIA					16 371 2050	Innova 125	125	10-12	14401-KSS-931
16 371 2020	Scarabeo 4t	50	02-14	96933R	16 371 2030	Pantheon 125 Fes	125	03-05	14401-KRJ-901
16 371 2020	Sr Motard 4t 4v	50	14	96933R	16 371 2050	Pcx 125	125	10-15	14401-KSS-931
16 371 2020	Scarabeo 4t	100	01-14	96933R	16 371 2050	Pcx 125 Limited Edition	125	12	14401-KSS-931
16 371 2070	Atlantic	125	06-12	82644R	16 371 2030	Pes 125 Injection	125	06-09	14401-KRJ-901
16 371 2200	Atlantic	125	03-05	82723R	16 371 2030	Pes 125 Injection Sporty	125	08-09	14401-KRJ-901
16 371 2200	Atlantic Eu3	125	06-08	82723R	16 371 2030	Ps 125 Injection	125	10-12	14401-KRJ-901
16 371 2140	Leonardo, Leonardo St	125	95-04	AP0297932	16 371 2030	Ps 125 Injection 2Ed	125	10	14401-KRJ-901
16 371 2030	Mojito	125	03-08	82643R	16 371 2030	Ps 125 Injection Sporty	125	10	14401-KRJ-901
16 371 2140	Scarabeo 125	125	98-06	AP0297932	16 371 2030	Ps 125 Injection Sporty 2Ed	125	10	14401-KRJ-901
16 371 2070	Sport City 125	125	04-12	82644R	16 371 2030	S Wing 125	125	12	14401-KRJ-901
16 371 2200	Sport City 125 Eu3	125	06-08	82723R	16 371 2030	S Wing 125 Abs	125	12	14401-KRJ-901
16 371 2070	Sport City 125 Cube 4Valv	125	07-09	82644R	16 371 2030	S Wing 125 Fes	125	07-09	14401-KRJ-901
16 371 2200	Sport City Cube	125	-	827223R	16 371 2030	S Wing 125 Fes 2Ed	125	11	14401-KRJ-901
16 371 2030	Sport City 125 One	125	08-11	82643R	16 371 2030	S Wing 125 Fes Abs	125	07-11	14401-KRJ-901
16 371 2070	Sr Max	125	11-14	82644R	16 371 2030	S Wing 125 Fes Abs 2Ed	125	11	14401-KRJ-901
16 371 2030	Sr Motard	125	12-13	82643R	16 371 2030	S Wing 125 Fes Abs Top Box	125	07	14401-KRJ-901
16 371 2140	Leonardo, Scarabeo	150	99-03	AP0297932	16 371 2030	Sh 125	125	07-11	14401-KRJ-901
16 371 2180	Leonardo	250	99-01	AP8122434	16 371 2050	Sh 125	125	13-16	14401-KSS-931
16 371 2200	Atlantic Eu3	250	06-08	82723R	16 371 2030	Sh 125 2Ed	125	07	14401-KRJ-901
16 371 2200	Scarabeo Light	250	06-08	82723R	16 371 2050	Sh 125 Abs	125	13-16	14401-KSS-931
16 371 2200	Sport City Cube	250	08-10	82723R	16 371 2050	Sh 125 Abs Sporty	125	14	14401-KSS-931
16 371 2200	Sr Max	300	11-14	82723R	16 371 2050	Sh 125 Abs Sporty Top Case	125	14	14401-KSS-931
16 371 2200	Atlantic	300	10-11	82723R	16 371 2050	Sh 125 Abs Top Case	125	14	14401-KSS-931
16 371 2200	Scarabeo Light	300	09-10	82723R	16 371 2050	Sh 125 D	125	16	14401-KSS-931
16 371 2100	Atlantic	400	05-08	827889	16 371 2050	Sh 125 D Abs	125	16	14401-KSS-931
16 371 2100	Scarabeo, Scarabeo Light	400	06-08	827889	16 371 2030	Sh 125 D Rear Drum	125	09	14401-KRJ-901
16 371 2100	Atlantic	500	01-08	827889	16 371 2050	Sh 125 Ds	125	16	14401-KSS-931
16 371 2100	Scarabeo, Scarabeo Light	500	06-08	827889	16 371 2050	Sh 125 Ds Abs	125	16	14401-KSS-931
DERBI					16 371 2030	Sh 125 Injection	125	05	14401-KRJ-901
16 371 2200	Rambla	125	08-09	82723R	16 371 2030	Sh 125 Injection Top Box	125	05-06	14401-KRJ-901
16 371 2200	Rambla	250	08-09	82723R	16 371 2030	Sh 125 R 2Ed Rear Drum	125	08	14401-KRJ-901
16 371 2200	Gp1	250	06-08	82723R	16 371 2030	Sh 125 R Rear Drum	125	08	14401-KRJ-901
16 371 2200	Rambla	300	10-11	82723R	16 371 2030	Sh 125 R Rear Drum, Top Box	125	10	14401-KRJ-901
GILERA					16 371 2030	Sh 125 R White	125	12	14401-KRJ-901
16 371 2070	Dna	125	01	82644R	16 371 2030	Sh 125 Rear Disk	125	09	14401-KRJ-901
16 371 2070	Nexus Eu3	125	08-10	82644R	16 371 2030	Sh 125 Rear Disk, Top Box	125	10	14401-KRJ-901
16 371 2070	Runner 4T St Eu3	125	08-13	82644R	16 371 2050	Sh 125 S	125	16	14401-KSS-931
16 371 2070	Runner Vx	125	00-07	82644R	16 371 2050	Sh 125 S Abs	125	16	14401-KSS-931
16 371 2070	Runner Vxr	200	05-11	82644R	16 371 2030	Sh 125 S Top Case	125	07-08	14401-KRJ-901
16 371 2200	Nexus	250	06-07	82723R	16 371 2030	Sh 125 S Top Case 2Ed	125	07	14401-KRJ-901
16 371 2200	Nexus	300	08-11	82723R	16 371 2050	Sh 125 Sporty	125	14	14401-KSS-931
16 371 2100	Fuoco	500	07-14	827889	16 371 2030	Sh 125 Top Box	125	12	14401-KRJ-901
16 371 2100	Nexus	500	03-11	827889	16 371 2050	Sh Mode 125	125	14-16	14401-KSS-931
HONDA					16 371 2030	Arobase 150	150	05-06	14401-KRJ-901
16 371 2040	Dio Vision 110	110	11	14401-GFM-971	16 371 2030	Pantheon 150 Fes	150	03-05	14401-KRJ-901
16 371 2040	Lead 110	110	08-12	14401-GFM-971	16 371 2050	Pcx 150	150	12-16	14401-KSS-931
16 371 2040	Vision 110	110	13-16	14401-GFM-971	16 371 2030	Pes 150 Injection	150	06-09	14401-KRJ-901
16 371 2030	Arobase 125	125	05-06	14401-KRJ-901	16 371 2030	Pes 150 R Two Tones	150	08-09	14401-KRJ-901
16 371 2050	Forza 125	125	15	14401-KSS-931	16 371 2030	Ps 150 Injection	150	10	14401-KRJ-901
16 371 2050	Forza 125 Abs	125	15-16	14401-KSS-931	16 371 2030	S Wing 150 Fes	150	09	14401-KRJ-901

CODICE RMS <i>RMS CODE</i>	MODELLO <i>MODEL</i>	CC.	ANNI <i>YEARS</i>	RIF. ORIGINALE <i>OEM NUMBER</i>
16 371 2030	S Wing 150 Fes Abs	150	07-09	14401-KRJ-901
16 371 2030	Sh 150	150	05-12	14401-KRJ-901
16 371 2050	Sh 150	150	13-16	14401-KSS-931
16 371 2030	Sh 150 2Ed	150	06-10	14401-KRJ-901
16 371 2050	Sh 150 Abs	150	14-16	14401-KSS-931
16 371 2050	Sh 150 Abs Sporty	150	14	14401-KSS-931
16 371 2050	Sh 150 D	150	13-16	14401-KSS-931
16 371 2050	Sh 150 D Abs	150	16	14401-KSS-931
16 371 2050	Sh 150 Ds	150	16	14401-KSS-931
16 371 2050	Sh 150 Ds Abs	150	16	14401-KSS-931
16 371 2030	Sh 150 R	150	08-12	14401-KRJ-901
16 371 2030	Sh 150 R Top Box	150	10	14401-KRJ-901
16 371 2030	Sh 150 Rear Disk	150	09	14401-KRJ-901
16 371 2050	Sh 150 S	150	16	14401-KSS-931
16 371 2030	Sh 150 S	150	08-11	14401-KRJ-901
16 371 2050	Sh 150 S Abs	150	16	14401-KSS-931
16 371 2050	Sh 150 Sporty	150	14	14401-KSS-931
16 371 2030	Sh 150 Top Box 2Ed	150	05	14401-KRJ-901
16 371 2190	Crf 230	230	04-08	14401-KFB-751
16 371 2190	Crf 230 F	230	09	14401-KFB-751
16 371 2190	Forza 250 Abs	250	08	14401-KFB-751
16 371 2190	Reflex 250 Sport	250	08	14401-KFB-751
16 371 2190	Forza 300	300	13-16	14401-KFB-751
16 371 2190	Forza 300 Abs	300	13-16	14401-KFB-751
16 371 2190	Sh 300	300	07-14	14401-KFB-751
16 371 2190	Sh 300 3E	300	09	14401-KFB-751
16 371 2190	Sh 300 Abs	300	07-14	14401-KFB-751
16 371 2190	Sh 300 Abs 3Ed	300	09	14401-KFB-751
16 371 2190	Sh 300 Abs Black	300	13	14401-KFB-751
16 371 2190	Sh 300 Abs Black Special	300	14	14401-KFB-751
16 371 2190	Sh 300 Abs Sport	300	09	14401-KFB-751
16 371 2190	Sh 300 Abs Sport 3Ed	300	09	14401-KFB-751
16 371 2190	Sh 300 Abs Sporty	300	14	14401-KFB-751
16 371 2190	Sh 300 Abs Sporty	300	14	14401-KFB-751
16 371 2190	Sh 300 Abs Top Box	300	10-11	14401-KFB-751
16 371 2190	Sh 300 Black Special	300	14	14401-KFB-751
16 371 2190	Sh 300 i Abs	300	15	14401-KFB-751
16 371 2190	Sh 300 R	300	12-13	14401-KFB-751
16 371 2190	Sh 300 R Abs	300	12-13	14401-KFB-751
16 371 2190	Sh 300 R Abs White	300	13	14401-KFB-751
16 371 2190	Sh 300 Spc	300	08-10	14401-KFB-751
16 371 2190	Sh 300 Spc 2F	300	08-10	14401-KFB-751
16 371 2190	Sh 300 Spc 3Ed	300	09	14401-KFB-751
16 371 2190	Sh 300 Sporty	300	14	14401-KFB-751
16 371 2190	Sh 300 Sporty Abs	300	08-10	14401-KFB-751
16 371 2190	Sh 300 Sporty Abs Top Box	300	10	14401-KFB-751
16 371 2190	Sh 300 Top Box	300	10	14401-KFB-751
16 371 2170	Silver Wing 400	400	07-08	14401-MCT-003
16 371 2170	Silver Wing 400	400	06-09	14401-MCT-003
16 371 2170	Silver Wing 400 Abs	400	09	14401-MCT-003
16 371 2170	Silver Wing 600	600	07	14401-MCT-003

CODICE RMS <i>RMS CODE</i>	MODELLO <i>MODEL</i>	CC.	ANNI <i>YEARS</i>	RIF. ORIGINALE <i>OEM NUMBER</i>
16 371 2170	Silver Wing 600	600	01-02	14401-MCT-003
16 371 2170	Silver Wing 600	600	03-11	14401-MCT-003
16 371 2170	Silver Wing 600 Abs	600	07	14401-MCT-003
16 371 2170	Silver Wing 600 Abs	600	03-11	14401-MCT-003
16 371 2170	Ctx 1300 Abs	1300	14	14401-MCT-003
16 371 2170	Pan European 1300 Abs	1300	02-14	14401-MCT-003
16 371 2170	Pan European St 1300	1300	02-09	14401-MCT-003
KYMCO				
16 371 2010	Agility	50	98-00	103612
16 371 2010	Agility 4t Carry	50	11	103612
16 371 2010	Agility Plus 4t	50	14	103612
16 371 2010	Agility R10	50	01-04	103612
16 371 2010	Agility R12	50	05-08	103612
16 371 2010	Agility R16	50	08-12	103612
16 371 2010	Dink	50	06-08	103612
16 371 2010	Filly, Filly Lx	50	07	103612
16 371 2010	People S	50	07-08	103612
16 371 2010	Sento	50	07-08	103612
16 371 2010	Super 8	50	07-13	103612
16 371 2010	Vitality 4t	50	04	103612
16 371 2030	Agility	125	06	123110
16 371 2030	Agility Eu3	125	06-08	123110
16 371 2030	Agility R16	125	08-12	123110
16 371 2030	Dink Eu3	125	06-07	123110
16 371 2030	Dink Eu3	125	06-07	123110
16 371 2030	G-Dink Eu3	125	12-13	123110
16 371 2030	Gran Dink Eu2	125	02-04	123110
16 371 2030	Like	125	09-12	123110
16 371 2030	Movie	125	99-00	123110
16 371 2030	Movie Eu3	125	06-07	123110
16 371 2030	Movie XL	125	01	123110
16 371 2030	Movie XL Eu2	125	03-04	123110
16 371 2030	People Eu2	125	03	123110
16 371 2030	People S	125	05	123110
16 371 2030	People S	125	05-07	123110
16 371 2030	People Eu3	125	07-12	123110
16 371 2030	People S Dd Eu3	125	07-08	123110
16 371 2030	Super 8	125	08-09	123110
16 371 2030	Vivio	125	-	123110
16 371 2130	B&w	125	00-04	123912
16 371 2130	Dink	125	97-98	123912
16 371 2130	Dink Classic	125	02-03	123912
16 371 2130	Dink Lx	125	98-00	123912
16 371 2030	Downtown i	125	09	114099
16 371 2030	K-Xct i	125	12-14	114099
16 371 2030	People Gti	125	10	114099
16 371 2030	Agility R16	150	08-09	123110
16 371 2030	Gran Dink	150	01-02	123110
16 371 2030	Gran Dink Eu2	150	03-04	123110
16 371 2030	Movie Eu3	150	06-07	123110
16 371 2030	Movie XL, XL Eu2	150	01-04	123110

CODICE RMS <i>RMS CODE</i>	MODELLO <i>MODEL</i>	CC.	ANNI <i>YEARS</i>	RIF. ORIGINALE <i>OEM NUMBER</i>	CODICE RMS <i>RMS CODE</i>	MODELLO <i>MODEL</i>	CC.	ANNI <i>YEARS</i>	RIF. ORIGINALE <i>OEM NUMBER</i>
16 371 2030	People	150	99-00	123110	16 371 2210	Tweet Pmx	50	-	801526
16 371 2130	B&w	150	00-04	123912	16 371 2210	Tweet V	50	-	801526
16 371 2130	Dink	150	97-98	123912	16 371 2210	Tweet N	50	-	801526
16 371 2130	Dink Classic	150	02-03	123912	16 371 2210	Tweet X	50	-	801526
16 371 2130	Dink Lx	150	98-00	123912	16 371 2210	Tweet	50	-	801526
16 371 2030	Agility R16	200	10-12	123110	16 371 2210	Viva 3L 4T	50	-	801526
16 371 2030	Dink Eu3	200	06-07	123110	16 371 2030	Looxor	125	-	756294
16 371 2030	Like	200	09-12	123110	16 371 2070	Citystar	125	-	766961
16 371 2030	People S	200	05-07	123110	16 371 2070	Satelis	125	-	766961
16 371 2270	Downtown i	200	10	114051	16 371 2070	Geopolis	125	-	766961
16 371 2270	People Gti	200	10-14	114051	16 371 2050	Tweet	125	-	802130
16 371 2130	Dink Classic	200	04	123912	16 371 2030	Looxor	150	-	756294
16 371 2080	B&w, B&w Eu2	250	00-03	123910	16 371 2050	Tweet	150	-	802130
16 371 2080	Gran Dink	250	01-02	123910	16 371 2070	Citystar	200	-	766961
16 371 2080	Gran Dink Eu2	250	03-04	123910	16 371 2200	Geopolis	250	-	758715
16 371 2080	People Lc	250	03-04	123910	16 371 2200	Setelis	250	-	758715
16 371 2080	People Si	250	07	123910	16 371 2200	Geopolis	300	-	758715
16 371 2080	X Citing	250	05-07	123910	16 371 2200	Setelis	300	-	758715
16 371 2080	Yup	250	03	123910	16 371 2100	Geopolis	400	-	759717
16 371 2270	Downtown	300	09-11	114051	16 371 2100	Satelis	400	-	759717
16 371 2270	K Xct i	300	12-14	114051	16 371 2100	Geopolis	500	-	759717
16 371 2270	People Gti	300	10-14	114051	16 371 2100	Satelis	500	-	759717
16 371 2270	Downtown Abs E4	350	16	114051	PIAGGIO				
16 371 2270	Downtown i Abs	350	15	114051	16 371 2020	Fly 4t	50	05-14	96933R
16 371 2270	X Citing	400	13-15	114051	16 371 2020	Free 4t	50	02-03	96933R
16 371 2290	X Citing	500	05	123058	16 371 2020	Liberty 4t	50	00-16	96933R
16 371 2290	X Citing i	500	06-08	123058	16 371 2020	Vespa Et 4	50	00-05	96933R
16 371 2290	X Citing R	500	07-09	123058	16 371 2020	Vespa Lx	50	05-13	96933R
MALAGUTI					16 371 2020	Vespa Primavera 4t 4v	50	15-16	96933R
16 371 2070	Ciak	125	00-03	51700400	16 371 2020	Vespa Sprint 4t 4v	50	14-16	96933R
16 371 2070	Ciak Master	125	06	51700400	16 371 2020	Zip 4t	50	00-13	96933R
16 371 2130	Madison 125	125	99-05	71700800	16 371 2020	Fly 4t	100	06-08	96933R
16 371 2070	Ciak	150	03	51700400	16 371 2020	Zip 4t	100	06-10	96933R
16 371 2070	Ciak Master	150	04	51700400	16 371 2070	Beverly	125	01-15	82644R
16 371 2130	Madison 150	150	99-01	71700800	16 371 2070	Carnaby	125	07-10	82644R
16 371 2070	Ciak Master	200	06	51700400	16 371 2030	Fly	125	05-11	82643R
16 371 2180	Madison S 250	250	02-03	91700100	16 371 2070	Hexagon	125	-	82644R
16 371 2180	Password Eu3	250	07-08	91700100	16 371 2240	Hexagon Lx4	125	98-99	436246
16 371 2100	Spider Max Gt Eu3	500	04-08	41701000	16 371 2030	Liberty	125	01-15	82643R
MBK					16 371 2240	Liberty	125	98-00	436246
16 371 2130	Dodo 125, Dodo 150	125	00-02	945914809400	16 371 2070	Mp3	125	07-13	82644R
16 371 2130	Skyliner, Skyliner 150	125	00-02	945914809400	16 371 2030	Sfera	125	96	82643R
16 371 2130	Thunder 125 Thunder 150	125	01-02	945914809400	16 371 2240	Sfera	125	95-97	436246
16 371 2180	Skyliner 250	250	00-03	945821710400	16 371 2030	Skipper St	125	00-02	82643R
16 371 2180	Yc Kilibre	300	03	945821710400	16 371 2070	Super Hexagon	125	01-02	82644R
PEUGEOT					16 371 2030	Thyphoon 4t 2v	125	10-12	82643R
16 371 2210	Fight 3 4T Dse	50	-	801526	16 371 2070	Vespa 125 Gt-Gts-Gtv	125	03-08	82644R
16 371 2210	Fight 3 A 4T Dse	50	-	801526	16 371 2030	Vespa Et 4	125	99-02	82643R
16 371 2210	Fight 3 Ar 4T	50	-	801526	16 371 2240	Vespa Et4	125	96-98	436246
16 371 2210	Fight 3 R 4T	50	-	801526	16 371 2030	Vespa Lx -Lxv	125	05-12	82643R
16 371 2210	Tweet A Pmx	50	-	801526	16 371 2030	Vespa S 4t	125	07-11	82643R

CODICE RMS <i>RMS CODE</i>	MODELLO <i>MODEL</i>	CC.	ANNI <i>YEARS</i>	RIF. ORIGINALE <i>OEM NUMBER</i>	CODICE RMS <i>RMS CODE</i>	MODELLO <i>MODEL</i>	CC.	ANNI <i>YEARS</i>	RIF. ORIGINALE <i>OEM NUMBER</i>
16 371 2070	X Evo	125	07-16	82644R	16 371 2090	Ue 150 Epicuro	150	99-01	12760-04B00-000
16 371 2070	X7	125	06-10	82644R	16 371 2090	Uh 150 Burgman	150	99-06	12760-04B00-000
16 371 2070	X8	125	04-07	82644R	16 371 2060	Ux Sixteen	150	08-11	12760-055A0-000
16 371 2030	X8 Street Eu2	125	06-07	82643R	16 371 2090	An 200 Burgman	200	07-16	12760-04B00-000
16 371 2070	X9	125	01-07	82644R	16 371 2150	An 250 Burgman, ie	250	98-06	12760-19B71-000
16 371 2030	Zip	125	00-02	82643R	16 371 2160	An 400 Burgman	400	07-15	12760-19F01-000
16 371 2030	Fly	150	05-11	82643R	16 371 2150	An 400 Burgman ie	400	99-06	12760-19B71-000
16 371 2070	Hexagon	150	99	82644R	16 371 2160	An 650 Burgman	650	06-14	12760-19F01-000
16 371 2030	Liberty	150	08-13	82643R	SYM				
16 371 2030	Vespa Lx	150	06-12	82643R	16 371 2250	Cinderella	50	99-02	1C14401A31000
16 371 2030	Vespa S 4t	150	07-12	82643R	16 371 2010	Fiddle 2	50	08	1C14401BE2A00
16 371 2030	X8 Street Eu2	150	06-08	82643R	16 371 2210	Fiddle 2 S	50	09-13	1C14401A1A000
16 371 2070	X9 Amalfi	180	-	82644R	16 371 2210	Fiddle 3	50	14	1C14401A1A000
16 371 2070	Beverly	200	01-03	82644R	16 371 2210	Jet 4	50	09-10	1C14401A1A000
16 371 2070	Carnaby	200	07-08	82644R	16 371 2210	Mio	50	06-09	1C14401A1A000
16 371 2030	Liberty	200	06-08	82643R	16 371 2210	Symply 2	50	09-14	1C14401A1A000
16 371 2070	Vespa Gt	200	06-07	82644R	16 371 2210	Symphony S	50	10-14	1C14401A1A000
16 371 2070	X 8	200	05-07	82644R	16 371 2210	Symphony Sr	50	10-14	1C14401A1A000
16 371 2070	X 9	200	02-03	82644R	16 371 2210	Symphony St	50	15	1C14401A1A000
16 371 2200	X9 Evolution	250	04-06	82723R	16 371 2210	Symphony	50	09	1C14401A1A000
16 371 2200	X8 Eu3	250	05-08	82723R	16 371 2210	X Pro	50	13	1C14401A1A000
16 371 2200	X Evo	250	07-16	82723R	16 371 2250	Cinderella	100	99-01	1C14401A31000
16 371 2200	X7	250	08-10	82723R	16 371 2250	Mio Eu2	100	05-06	1C14401A31000
16 371 2200	Vespa Gts	250	05-16	82723R	16 371 2250	Mio Eu3	100	07-08	1C14401A31000
16 371 2200	Vespa Gtv	250	06-09	82723R	16 371 2050	Fiddle 2	125	10-13	1C14401F6A000
16 371 2200	Mp3	250	06-09	82723R	16 371 2050	Jet 4	125	09-10	1C14401F6A000
16 371 2200	Beverly	250	04-08	82723R	16 371 2050	Symphony S	125	09-14	1C14401F6A000
16 371 2200	Beverly Rst 4T 4V ie Eu3	250	10-15	82723R	16 371 2050	Sr	125	10-14	1C14401F6A000
16 371 2200	Mp3 Lt Business-Sport- Abs	300	14-15	82723R	16 371 2050	Symply 2	125	14-15	1C14401F6A000
16 371 2200	Mp3 Yourban Erl	300	14-15	82723R	16 371 2050	X Pro	125	13	1C14401F6A000
16 371 2200	Vespa Gtv	300	07-13	82723R	16 371 2040	Fiddle 2	125	08-09	1C14401V02000
16 371 2200	Vespa Gts	300	05-13	82723R	16 371 2040	New Duke	125	00-01	1C14401V02000
16 371 2200	Mp3	300	10-13	82723R	16 371 2040	Super Duke	125	99-02	1C14401V02000
16 371 2200	Carnaby	300	08-12	82723R	16 371 2040	Symply 2	125	09-10	1C14401V02000
16 371 2200	Beverly	300	08-13	82723R	16 371 2040	Symply	125	07-08	1C14401V02000
16 371 2200	Vespa Gts ie & Touring	300	12-16	82723R	16 371 2030	Attila	125	99-00	1C14401M92000
16 371 2200	Vespa Gts Super	300	08-15	82723R	16 371 2030	Fiddle 3	125	14-15	1C14401M92000
16 371 2280	Beverly 4T 4V ie	350	11-14	82992R	16 371 2030	Gts Joymax	125	06-07	1C14401M92000
16 371 2280	X10 4T 4V ie	350	12-15	82992R	16 371 2030	Hd Eu2/Eu3	125	03-08	1C14401M92000
16 371 2100	Beverly	400	06-10	827889	16 371 2030	Hd Evo	125	05-11	1C14401M92000
16 371 2100	Mp3	400	07-11	827889	16 371 2030	Hd2	125	11-14	1C14401M92000
16 371 2100	X8	400	06-08	827889	16 371 2030	Joyride	125	03-07	1C14401M92000
16 371 2100	Xevo	400	07-11	827889	16 371 2030	Joyride Evo	125	09-14	1C14401M92000
16 371 2100	Beverly	500	02-08	827889	16 371 2050	Fiddle 2	150	10-12	1C14401F6A000
16 371 2100	Mp3	500	11-15	827889	16 371 2050	Symphony S	150	09-14	1C14401F6A000
16 371 2100	X10	500	12-14	827889	16 371 2050	Symphony Sr	150	10-14	1C14401F6A000
16 371 2100	X9	500	01-07	827889	16 371 2030	Attila	150	03-04	1C14401M92000
SUZUKI					16 371 2030	Joyride	150	01-02	1C14401M92000
16 371 2090	Ue 125 Epicuro	125	99-01	12760-04B00-000	16 371 2030	Vs	150	06-08	1C14401M92000
16 371 2090	Uh 125 Burgman	125	02-16	12760-04B00-000	16 371 2030	Hd Eu2/Eu3	200	03-07	1C14401M92000
16 371 2060	Ux Sixteen	125	08-11	12760-055A0-000	16 371 2030	Hd Evo	200	05-12	1C14401M92000

CODICE RMS RMS CODE	MODELLO MODEL	CC.	ANNI YEARS	RIF. ORIGINALE OEM NUMBER	CODICE RMS RMS CODE	MODELLO MODEL	CC.	ANNI YEARS	RIF. ORIGINALE OEM NUMBER
16 371 2030	Hd2 l	200	11-14	1C14401M92000	16 371 2130	Yp 125 Majesty	125	98-09	945914809400
16 371 2030	Joyride	200	03-06	1C14401M92000	16 371 2070	Yp125R X-Max	125	15-16	94568A809600
16 371 2030	Joyride i	200	07-10	1C14401M92000	16 371 2070	Yp125R X-Max Abs	125	15-16	94568A809600
16 371 2030	Joyride Evo i	200	09-14	1C14401M92000	16 371 2130	Fly One 150	150	92	945914809400
16 371 2260	Yoymax Eu3 i	250	07-08	1C14401RFA000	16 371 2130	Xn 150 N Teo's	150	00-02	945914809400
16 371 2260	Citycom	300	08-15	1C14401RFA000	16 371 2130	Xq 150 N Maxster	150	00-03	945914809400
16 371 2260	Citycom E Efi	300	10-12	1C14401RFA000	16 371 2130	Yp 150 Majesty	150	00-03	945914809400
16 371 2260	Citycom S i Cbs	300	15	1C14401RFA000	16 371 2070	Hw Xenter	150	12-16	945687509600
16 371 2260	Joymax Evo	300	09	1C14401RFA000	16 371 2130	Yp 180 Majesty	180	03-06	945914809400
16 371 2260	Joymax Evo i	300	10	1C14401RFA000	16 371 2180	Vp X-City	250	07-15	945821710400
16 371 2260	Joymax i	300	12-14	1C14401RFA000	16 371 2180	Yp 250 R X-Max	250	05-16	945821710400
16 371 2270	Maxsym	400	11-12	1C14401L4A000	16 371 2180	Yp 250 RA X-Max Abs	250	11-16	945821710400
YAMAHA									
16 371 2010	Xf Giggle	50	08	5STE21900000	16 371 2180	Yp Majesty, Dx, Abs	250	96-04	945821710400
16 371 2010	Ns50F Aerox F	50	14-16	5STE21900000	16 371 2180	Xc Versity	300	03-06	945821710400
16 371 2010	Yn F Neo's 4	50	09-15	5STE21900000	16 371 2120	Yp 400 Majesty	400	04-11	945821813600
16 371 2070	X-City	125	07-13	94568A809600	16 371 2120	X Max 400	400	13-14	945821813600
16 371 2070	X-Max	125	07-13	94568A809600	16 371 2110	Yp 500 T-Max	500	01-11	945821813200
16 371 2070	Hw Xenter	125	12-16	94568A809600	16 371 2310	Yp T-Max	530	12-16	945915313400
16 371 2070	Xc R Majesty S	125	14	94568A809600	16 371 2310	Yp T-Max Abs	530	12-16	945915313400
16 371 2130	Xn 125 N Teo's	125	00-02	945914809400	16 371 2310	Yp T-Max Sp Abs	530	12-16	945915313400
16 371 2130	Xq 125 N Maxster	125	00-03	945914809400	16 371 2310	Yp T-Max Sp	530	12-16	945915313400

Codice Kmc Kmc Code	P	W	T1	T2	H	d	L	-	-
	Passo Pitch	Larghezza Interna Roller Link Width	Spessore maglia esterna Outer plate thickness	Spessore maglia interna Inner plate thickness	Altezza maglia interna Inner plate height	Diam. Perno Pin Diameter	Lunghezza Perno Over-All Width. Riv.	Carico Rottura Minimo Minimum Tensile Strength	Carico Rottura Medio Average Tensile Strength
UNITÀ DI MISURA UNIT OF MEASURE	mm.	mm.	mm.	mm.	mm.	mm.	mm.	kgf	kgf
2023LN	6,35	3,05	0,7	1,0	6,70	2,42	6,10	550	660
2034LN	6,35	5,10	0,7	1,0	6,70	2,42	8,25	800	1100
2023LW	6,35	3,05	0,7	1,0	6,72	2,72	6,10	520	620
2034LW	6,35	5,10	0,7	1,0	6,72	2,72	8,25	700	850

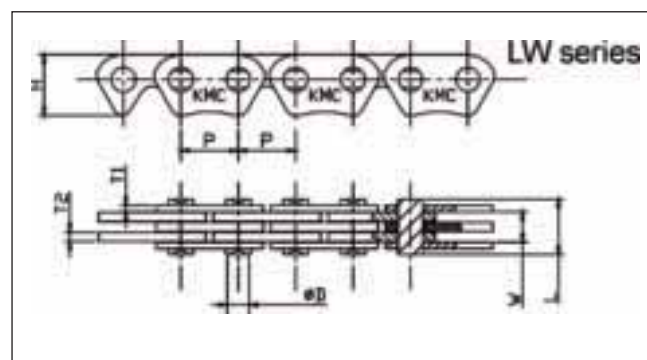
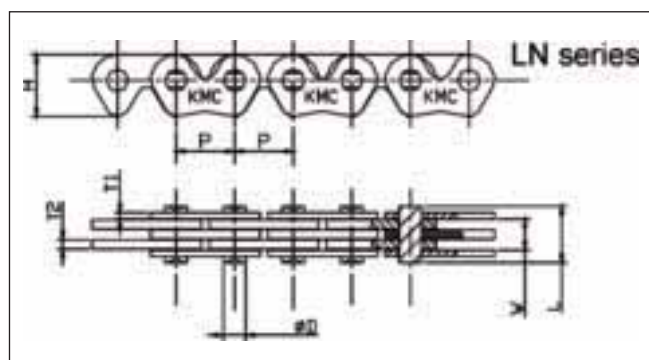

16 371 9180 

GIUNTO CATENA - CONNECTING LINK
2023 LN



16 371 9190 

GIUNTO CATENA - CONNECTING LINK
2023 LW



16 371 9200 

GIUNTO CATENA - CONNECTING LINK
2034 LN



16 371 9210 

GIUNTO CATENA - CONNECTING LINK
2034 LW



CATENE POMPA OLIO - OIL PUMP CHAINS

16 371 2220 

MODELLO - MODEL

25H



APRILIA 50: Scarabeo 4T Restyling 06-09 • Scarabeo Quattro 09 • Scarabeo 4T 4V 09-14 • Sport City One 4T 08-10 • Sr Motard 4T 4V 13-14
100: Scarabeo 4T 06-14

DERBI 50: Atlantis 4T 04-07 • Boulevard 4T 09 • **100:** Boulevard 4T 10-11

PIAGGIO 50: Fly 4T 05-14 • Liberty 4T 00-14 • Vespa Lx 4T 05-08 • Vespa Lx 4T 4V 09-14 • Vespa Primavera 4T 4V 13-14 • Vespa Sprint 4T 4V 14
 Zip 4T 00-13 • **100:** Fly 4T 06-08 • Free 02-03 • Zip 4T 06-10 • **125:** Hexagon Lx4 98-99 • Liberty 98-00 • Sfera 95-97 • Vespa Et4 96-98
 (R.O. 434447)

16 371 2230 

MODELLO - MODEL

25H



APRILIA 125: Atlantic Eu3 06-12 • Atlantic 03-05 • Mojito 03-08 • Scarabeo 03-06 • Sport City Cube 08-10 • Sport City Eu3 04-08 • Sport City One
 4T 08-11 • Sport City Street 12 • Sr Max 11-14 • Sr Motard 12-14 • **250:** Scarabeo Light 06-08 • Sport City Cube 08-12 • **300:** Atlantic 10-11 • Scarabeo
 Light 09-10 • Sport City Street 12 • Sr Max 11-14

DERBI 125: Boulevard 03-12 • Gp1 07-08 • Rambla 08-09 • Sonar 09-11 • Variant Sport 12 • **150:** Boulevard 10 • Sonar 09 • **200:** Boulevard Eu2
 05-06 • **250:** Gp1 06-08 • **300:** Rambla 10-11

GILERA 125: Dna 01 • Nexus 07-10 • Runner 4T 00-13 • **200:** Runner 4T 05-11 • **250:** Nexus 06-07 • **300:** Nexus 08-11

PIAGGIO 125: Beverly 01-13 • Fly 05-11 • Liberty 4T 01-12 • Mp3 06-12 • Skipper 4T 00-02 • Vespa Et4 99-02 • Vespa Gts 03-12 • Vespa Gtv 06-08
 • Vespa Lx 05-11 • Vespa S 4T 07-11 • X Evo 07-12 • X10 4T 4V 12-13 • X7 08-10 • X8 04-07 • X9 01-07 • Zip 00-02 • **150:** Fly 05-11 • Liberty 08-13 •
 Vespa Lx 05-12 • Vespa S 4T 08-12 • X8 06-08 • **180:** X9 00-03 • **200:** Carnaby 07-08 • Liberty 04-08 • Vespa Gts 06-07 • X8 05-07 • X9 02-03 • **250:**
 Beverly 04-09 • Carnaby 08 • Mp3 06-09 • Vespa Gts 05-14 • Vespa Gtv 06-09 • X Evo 07-13 • X7 08 • X8 05-08 • X9 04-08 • **300:** Beverly 09-14 •
 Carnaby Cruiser 09-12 • Mp3 10-14 • Vespa Gts 08-14 • Vespa Gtv 09-10 • X7 Evo 09-10
 (R.O. 82649R)



			10 066 9200		
			APRILIA-PIAGGIO: 843307 (Conf. 10 pezzi - 10 pcs/pack)		
10 066 9210		10 066 9220		10 066 9230	
APRILIA-DERBI-GILERA: 436438 PEUGEOT: 756140 - PIAGGIO: 436438 (Conf. 10 pezzi - 10 pcs/pack)		APRILIA: AP8122606 YAMAHA: 5H0121190000 (Conf. 10 pezzi - 10 pcs/pack)		APRILIA: AP0650120 (Conf. 10 pezzi - 10 pcs/pack)	
10 066 9240		10 066 9250		10 066 9260	
HONDA: 12209-GB4-681 KYMCO: 00122779 (Conf. 10 pezzi - 10 pcs/pack)		HONDA: 12209-MA6-003 - PEUGEOT: 766514 SUZUKI: 09289-04002-000-YAMAHA: 52SE21190000 (Conf. 10 pezzi - 10 pcs/pack)		PEUGEOT: 800984 (Conf. 10 pezzi - 10 pcs/pack)	
10 066 9270		10 066 9280		10 066 9290	
YAMAHA: 5STE21190000 (Conf. 10 pezzi - 10 pcs/pack)		SUZUKI: 09289-05011-000 (Conf. 10 pezzi - 10 pcs/pack)		SYM: 12209H6B900 (Conf. 10 pezzi - 10 pcs/pack)	
10 066 9300		10 066 9310		10 066 9320	
HONDA: 12208-ML0-721 - 12208-ML0-722 YAMAHA: 5YPE21190000 (Conf. 10 pezzi - 10 pcs/pack)		YAMAHA: 3P6121290000 (Conf. 10 pezzi - 10 pcs/pack)		YAMAHA: 4TV121190000 (Conf. 10 pezzi - 10 pcs/pack)	



PARAOLI VALVOLE VALVES OIL SEALS

MODELLO - MODEL	Cc	ANNI YEARS	CODICE RMS RMS CODE	RIF. ORIGINALE OEM NUMBER	MODELLO - MODEL	Cc	ANNI YEARS	CODICE RMS RMS CODE	RIF. ORIGINALE OEM NUMBER
APRILIA					Srv-Srv Abs Atc	850	12-14	10 066 9210	436438
Scarabeo 4T	50	02-06	10 066 9210	436438	Rsv4 R	1000	11-12	10 066 9210	436438
Scarabeo 4T 4V	50	10-12	10 066 9200	843307	Rsv4 R Abs	1000	13-14	10 066 9210	436438
Scarabeo 4T 4V	50	14	10 066 9200	843307	Rsv4 Factory-Sbk Racing	1000	09-10	10 066 9210	436438
Scarabeo 4T 4V Net	50	09-10	10 066 9200	843307	Rsv4 Factory Abs	1000	13-14	10 066 9210	436438
Scarabeo 4T Restyling Eu3	50	06-09	10 066 9210	436438	Rsv4 Factory Std-Se	1000	11-12	10 066 9210	436438
Scarabeo Quattro	50	09	10 066 9200	843307	Rsv4 R	1000	09-10	10 066 9210	436438
Sport City One 4T	50	08-10	10 066 9210	436438	Tuono V4 R Abs	1000	14	10 066 9210	436438
Sr Motard 4T 4V	50	13-14	10 066 9200	843307	Tuono V4 R Std	1000	11-13	10 066 9210	436438
Scarabeo 4T	100	01-05	10 066 9210	436438	DERBI				
Scarabeo 4T	100	10-12	10 066 9210	436438	Atlantis 4T Eu2	50	07	10 066 9210	436438
Scarabeo 4T	100	14	10 066 9210	436438	Atlantis 50- 100 4T	50	04-06	10 066 9210	436438
Scarabeo 4T Net	100	09	10 066 9210	436438	Boulevard 4T Eu2 25 Km/H	50	09	10 066 9210	436438
Scarabeo 4T Net Eu3	100	10	10 066 9210	436438	Boulevard 4T	100	10-11	10 066 9210	436438
Scarabeo 4T Restyling	100	06-09	10 066 9210	436438	Boulevard 125- 150	125	02-04	10 066 9210	436438
Atlantic	125	03-05	10 066 9210	436438	Boulevard 125- 150 Eu2	125	04-07	10 066 9210	436438
Atlantic Eu3	125	10-12	10 066 9210	436438	Boulevard 4T Eu3	125	08-12	10 066 9210	436438
Atlantic Eu3 125- 250	125	06-08	10 066 9210	436438	Gp1 Eu2	125	06	10 066 9210	436438
Leonardo	125	96-02	10 066 9230	AP0650120	Gp1 Low Seat Eu3	125	07-08	10 066 9210	436438
Leonardo St	125	01-04	10 066 9230	AP0650120	Rambla 125- 250	125	08-09	10 066 9210	436438
Mojito	125	03-08	10 066 9210	436438	Rambla 125- 250 E3 2Ver	125	08	10 066 9210	436438
Mojito Retrò-Custom	125	99-01	10 066 9210	436438	Sonar 4T	125	09-11	10 066 9210	436438
Scarabeo	125	03-06	10 066 9210	436438	Variant Sport 4T E3	125	12	10 066 9210	436438
Scarabeo Mot. Piaggio Eu3	125	06	10 066 9210	436438	Boulevard 4T E3	150	10	10 066 9210	436438
Scarabeo Motore Rotax	125	99-04	10 066 9230	AP0650120	Boulevard Eu2	200	05-06	10 066 9210	436438
Sport City	125	04-06	10 066 9210	436438	Gp1	250	06-07	10 066 9210	436438
Sport City Cube	125	08-10	10 066 9210	436438	Gp1 Low Seat Eu3	250	07-08	10 066 9210	436438
Sport City Eu3	125	06-08	10 066 9210	436438	Rambla	300	10-11	10 066 9210	436438
Sport City One 4T Eu3	125	08-11	10 066 9210	436438	GILERA				
Sport City Street	125	12	10 066 9210	436438	Dna 125- 180	125	01	10 066 9210	436438
Sr Max	125	11-14	10 066 9210	436438	Nexus Eu3	125	07-08	10 066 9210	436438
Sr Motard	125	12-14	10 066 9210	436438	Nexus Eu3 ie	125	08-10	10 066 9210	436438
Leonardo	250	99-04	10 066 9220	AP8122606	Runner 4T St Eu3	125	08-13	10 066 9210	436438
Leonardo St	250	01	10 066 9220	AP8122606	Runner Vx	125	05-06	10 066 9210	436438
Scarabeo Light	250	06-08	10 066 9210	436438	Runner Vx 4T Eu3	125	06-07	10 066 9210	436438
Sport City Cube	250	08-10	10 066 9210	436438	Runner Vx Race	125	06	10 066 9210	436438
Atlantic	300	10-11	10 066 9210	436438	Runner Vx Sc	125	06-07	10 066 9210	436438
Scarabeo Light	300	09-10	10 066 9210	436438	Runner Vx- Vxr 125- 180	125	00-01	10 066 9210	436438
Sport City Street	300	12	10 066 9210	436438	Runner Vx- Vxr 125- 200	125	02-04	10 066 9210	436438
Sr Max	300	11-14	10 066 9210	436438	Runner Vxr	200	05-06	10 066 9210	436438
Atlantic Sprint 400-500	400	05-08	10 066 9210	436438	Runner Vxr 4T St Eu3	200	08-11	10 066 9210	436438
Scarabeo Light 400-500	400	06-08	10 066 9210	436438	Runner Vxr Eu3	200	07	10 066 9210	436438
Atlantic	500	01-04	10 066 9210	436438	Runner Vxr Race	200	05-06	10 066 9210	436438
Scarabeo	500	03-06	10 066 9210	436438	Nexus Eu3	250	06-07	10 066 9210	436438
Pegaso (Fun)-Factory-Trail	660	05-09	10 066 9220	AP8122606	Nexus Sp Eu3	250	06-07	10 066 9210	436438
Dorsoduro	750	08-14	10 066 9210	436438	Oregon	250	06-10	10 066 9210	436438
Dorsoduro Factory	750	10-13	10 066 9210	436438	Nexus Eu3	300	08-11	10 066 9210	436438
Shiver	750	07-14	10 066 9210	436438	Fuoco 4T- 4V ie E3 Lt	500	13-14	10 066 9210	436438
Shiver Gt	750	09	10 066 9210	436438	Fuoco Eu3	500	07-13	10 066 9210	436438
Mana	850	07-11	10 066 9210	436438	Nexus	500	03-05	10 066 9210	436438
Mana Gt	850	09-13	10 066 9210	436438	Nexus Eu3	500	06-11	10 066 9210	436438



MODELLO - MODEL	Cc	ANNI YEARS	CODICE RMS RMS CODE	RIF. ORIGINALE OEM NUMBER	MODELLO - MODEL	Cc	ANNI YEARS	CODICE RMS RMS CODE	RIF. ORIGINALE OEM NUMBER
Nexus Sp Eu3	500	06-07	10 066 9210	436438	Integra 700	700	12-13	10 066 9250	12209-MA6-003
Gp	800	07-11	10 066 9210	436438	Nc 700 35Kw	700	12-13	10 066 9250	12209-MA6-003
Gp Centenario	800	09	10 066 9210	436438	Nc 700 Abs 35Kw	700	12-13	10 066 9250	12209-MA6-003
HONDA					Nc 700 Abs Dct 35Kw	700	12-13	10 066 9250	12209-MA6-003
Vision 110	110	12	10 066 9250	12209-MA6-003	Nc 700 X	700	12	10 066 9250	12209-MA6-003
@125	125	01-06	10 066 9250	12209-MA6-003	Nc 700 X 35Kw	700	12-13	10 066 9250	12209-MA6-003
Ch 125 Spacy	125	93-96	10 066 9250	12209-MA6-003	Nc 700 X Abs	700	12-13	10 066 9250	12209-MA6-003
Ch Spacy	125	84-86	10 066 9250	12209-MA6-003	Nc 700 X Abs 35Kw	700	12-13	10 066 9250	12209-MA6-003
Dylan 125	125	02-04	10 066 9250	12209-MA6-003	Nc 700 X Abs Dct	700	12-13	10 066 9250	12209-MA6-003
Dylan 125	125	02-04	10 066 9250	12209-MA6-003	Integra 750	750	16	10 066 9250	12209-MA6-003
Pantheon Fes	125	03-05	10 066 9250	12209-MA6-003	Integra 750	750	16	10 066 9250	12209-MA6-003
Pes 125 Injection	125	06-12	10 066 9250	12209-MA6-003	Nc 750 J Vultus	750	15	10 066 9250	12209-MA6-003
S Wing 125 Fes	125	07-10	10 066 9250	12209-MA6-003	Nc 750 S	750	14-16	10 066 9250	12209-MA6-003
S Wing 125 Fes Abs	125	07-12	10 066 9250	12209-MA6-003	Nc 750 S Abs	750	14-15	10 066 9250	12209-MA6-003
Sh 125	125	01-12	10 066 9250	12209-MA6-003	Nc 750 S Abs	750	14-16	10 066 9250	12209-MA6-003
@150	150	00-01	10 066 9250	12209-MA6-003	Nc 750 S Dct	750	14-16	10 066 9250	12209-MA6-003
Crf 150	150	07-09	10 066 9300	12208-ML0-721	Nc 750 X	750	14-16	10 066 9250	12209-MA6-003
Crf 150 Expert	150	07-13	10 066 9300	12208-ML0-721	Nc 750 X Abs	750	14-15	10 066 9250	12209-MA6-003
Crf 150 R	150	10-14	10 066 9300	12208-ML0-721	Nc 750 X Abs	750	14-16	10 066 9250	12209-MA6-003
Dylan 150	150	02-04	10 066 9250	12209-MA6-003	Nc 750 X Abs Dct	750	14-15	10 066 9250	12209-MA6-003
Pantheon 150 Fes	150	03-09	10 066 9250	12209-MA6-003	Nc 750 X Abs Dct	750	14-16	10 066 9250	12209-MA6-003
Pes 150 Injection	150	06-10	10 066 9250	12209-MA6-003	Rc45 Rvf 750	750	94-95	10 066 9300	12208-ML0-721
S Wing 150 Fes Abs	150	03-07	10 066 9250	12209-MA6-003	Shadow 750	750	93-99	10 066 9300	12208-ML0-721
Sh 150	150	01-12	10 066 9250	12209-MA6-003	Vfr 750	750	90-97	10 066 9300	12208-ML0-721
Cn	250	88-99	10 066 9250	12209-MA6-003	Crossrunner 800	800	11-15	10 066 9300	12208-ML0-721
Crf 250	250	10-11	10 066 9300	12208-ML0-721	Vfr 800	800	02-04	10 066 9300	12208-ML0-721
Crf 250 R	250	12-15	10 066 9300	12208-ML0-721	Vfr 800	800	98-01	10 066 9300	12208-ML0-721
Forza 300	300	13	10 066 9300	12208-ML0-721	Vfr 800 Abs	800	02-04	10 066 9300	12208-ML0-721
Forza 300	300	13	10 066 9300	12208-ML0-721	Vfr 800 F	800	14-15	10 066 9300	12208-ML0-721
Forza 300 Abs	300	13	10 066 9300	12208-ML0-721	Vfr 800 Vtec	800	05-09	10 066 9300	12208-ML0-721
Forza 300 Abs	300	13-15	10 066 9300	12208-ML0-721	Vfr 800 Vtec Abs	800	05-09	10 066 9300	12208-ML0-721
Sh 300	300	07-16	10 066 9300	12208-ML0-721	Crosstourer 1200	1200	12-16	10 066 9300	12208-ML0-721
Rvf 400	400	96	10 066 9300	12208-ML0-721	Crosstourer 1200	1200	15-16	10 066 9300	12208-ML0-721
Silver Wing 400	400	06-09	10 066 9300	12208-ML0-721	Vfr 1200	1200	10-13	10 066 9300	12208-ML0-721
Sw T 400 Abs	400	09	10 066 9300	12208-ML0-721	Vfr 1200	1200	15	10 066 9300	12208-ML0-721
Vfr 400	400	90-91	10 066 9300	12208-ML0-721	Vfr 1200 Dct	1200	12-15	10 066 9300	12208-ML0-721
CB 500	500	02-06	10 066 9300	12208-ML0-721	F6b 1800 Bagger	1800	13-15	10 066 9250	12209-MA6-003
CB 500	500	94-02	10 066 9300	12208-ML0-721	GL1800 Gold Wing	1800	01-16	10 066 9250	12209-MA6-003
Cbf 500	500	04-06	10 066 9300	12208-ML0-721	KYMCO				
Cbf 500 Abs	500	04-06	10 066 9300	12208-ML0-721	Agility 4T Carry	50	11	10 066 9240	00122779
Silver Wing 600	600	01-10	10 066 9300	12208-ML0-721	Agility 4T R10	50	06-08	10 066 9240	00122779
Silver Wing 600 Abs	600	03-07	10 066 9300	12208-ML0-721	Agility 4T R12	50	07-08	10 066 9240	00122779
Ctx 700 Abs	700	14	10 066 9250	12209-MA6-003	Agility 4T R16	50	08-09	10 066 9240	00122779
Ctx 700 Abs	700	14	10 066 9250	12209-MA6-003	Agility 4T R16	50	12	10 066 9240	00122779
Ctx 700 Dual Clutch	700	14	10 066 9250	12209-MA6-003	Agility R12	50	05	10 066 9240	00122779
Ctx 700 Dual Clutch	700	14	10 066 9250	12209-MA6-003	Agility Rs	50	09	10 066 9240	00122779
Ctx 700 N	700	14	10 066 9250	12209-MA6-003	Filly	50	98-00	10 066 9240	00122779
Ctx 700 N Abs	700	14	10 066 9250	12209-MA6-003	Filly Lx	50	01-02	10 066 9240	00122779
Ctx 700 N Abs	700	14	10 066 9250	12209-MA6-003	Like 4T	50	09	10 066 9240	00122779
Ctx 700 N Dual Clutch	700	14	10 066 9250	12209-MA6-003	Super 8	50	07	10 066 9240	00122779
Ctx 700 N Dual Clutch	700	14	10 066 9250	12209-MA6-003	Super 8 4T	50	09	10 066 9240	00122779



PARAOLI VALVOLE VALVES OIL SEALS

MODELLO - MODEL	Cc	ANNI YEARS	CODICE RMS RMS CODE	RIF. ORIGINALE OEM NUMBER	MODELLO - MODEL	Cc	ANNI YEARS	CODICE RMS RMS CODE	RIF. ORIGINALE OEM NUMBER
Super 8 4T	50	13	10 066 9240	00122779	Like Lx	200	12	10 066 9240	00122779
Vitality 4T	50	04	10 066 9240	00122779	People Gti	200	10	10 066 9240	00122779
Agility Rs	125	09	10 066 9240	00122779	People Gti	200	14	10 066 9240	00122779
Agility 4T	125	06	10 066 9240	00122779	People S	200	05	10 066 9240	00122779
Agility 4T Eu3	125	06-08	10 066 9240	00122779	People S I	200	07	10 066 9240	00122779
Agility Carry	125	11	10 066 9240	00122779	B&w	250	00	10 066 9240	00122779
Agility Plus	125	14	10 066 9240	00122779	B&w Eu2	250	03	10 066 9240	00122779
Agility R16	125	08-09	10 066 9240	00122779	Grand Dink	250	01-02	10 066 9240	00122779
Agility R16	125	12	10 066 9240	00122779	Grand Dink Eu2	250	03-04	10 066 9240	00122779
B&w 125-150	125	00	10 066 9240	00122779	Kxr	250	03-04	10 066 9240	00122779
B&w 125-150 Eu2	125	03-04	10 066 9240	00122779	People S	250	06	10 066 9240	00122779
Dink Eu3	125	06-07	10 066 9240	00122779	Venox Eu3	250	07	10 066 9240	00122779
Dink Eu3	125	06-07	10 066 9240	00122779	X Citing I	250	05-07	10 066 9240	00122779
Dink 125-150	125	97-98	10 066 9240	00122779	X Citing I	500	06-07	10 066 9240	00122779
Dink Classic 125-150	125	02	10 066 9240	00122779	PEUGEOT				
Dink Classic 125-150 Eu2	125	03	10 066 9240	00122779	Tweet	50	-	10 066 9260	800984
Dink Lx 125-150	125	98-00	10 066 9240	00122779	Tweet A Pmx	50	-	10 066 9260	800984
G-Dink	125	12	10 066 9240	00122779	Tweet N	50	-	10 066 9260	800984
Grand Dink 125-150	125	01-02	10 066 9240	00122779	Tweet Pmx	50	-	10 066 9260	800984
Grand Dink 125-150 Eu2	125	03-04	10 066 9240	00122779	Tweet V	50	-	10 066 9260	800984
Heroism	125	95-97	10 066 9240	00122779	Tweet X	50	-	10 066 9260	800984
K-Pipe	125	12-13	10 066 9240	00122779	City Star	125	-	10 066 9260	800984
Like	125	09	10 066 9240	00122779	Citystar 125 Lc	125	-	10 066 9250	766514
Like Lx	125	12	10 066 9240	00122779	Citystar 125 Lc Av	125	-	10 066 9250	766514
Movi E Euk3	125	06-07	10 066 9240	00122779	Citystar 125 Lc Mx	125	-	10 066 9250	766514
Movie	125	99-00	10 066 9240	00122779	Fight3 125	125	-	10 066 9260	800984
Movie 1Euk3	125	06-07	10 066 9240	00122779	Fight3 125 Ds	125	-	10 066 9260	800984
Movie XL 125-150	125	01	10 066 9240	00122779	Fight3 125	125	-	10 066 9260	800984
Movie XL 125-150 Eu2	125	03-04	10 066 9240	00122779	Geo 125	125	-	10 066 9250	766514
People 125-150	125	99-00	10 066 9240	00122779	Looxor	125	-	10 066 9210	756140
People 125-150 Eu2	125	03	10 066 9240	00122779	Lxr 125	125	-	10 066 9260	800984
People Eu3	125	07-08	10 066 9240	00122779	Sat 125	125	-	10 066 9250	766514
People Eu3	125	11	10 066 9240	00122779	Tweet 125	125	-	10 066 9260	800984
People One I	125	13	10 066 9240	00122779	Citystar 150	150	-	10 066 9260	800984
People S	125	05	10 066 9240	00122779	Looxor 150 F	150	-	10 066 9210	756140
People S Dd Eu3	125	07-08	10 066 9240	00122779	Tweet 150	150	-	10 066 9260	800984
Quannon	125	08	10 066 9240	00122779	Citystar 200 Lc	200	-	10 066 9250	766514
Quannon Naked	125	10	10 066 9240	00122779	Lxr 200	200	-	10 066 9260	800984
Super 8	125	08-09	10 066 9240	00122779	Geo 250	250	-	10 066 9210	756140
Vivio 125-150	125	00	10 066 9240	00122779	Sat 250	250	-	10 066 9210	756140
Agility R16	150	08-09	10 066 9240	00122779	Geo	300	-	10 066 9210	756140
Heroism	150	95-97	10 066 9240	00122779	Sat 2	300	-	10 066 9210	756140
Movi E Eu3	150	06-07	10 066 9240	00122779	Geo C	400	-	10 066 9210	756140
Movie Eu3	150	06-07	10 066 9240	00122779	Geo S	400	-	10 066 9210	756140
Agility I R16	200	10	10 066 9240	00122779	Geo Sc	400	-	10 066 9210	756140
Agility I Plus	200	14	10 066 9240	00122779	Geo X	400	-	10 066 9210	756140
Agility R16	200	12	10 066 9240	00122779	Geo Xn	400	-	10 066 9210	756140
Dink Eu3i	200	06-07	10 066 9240	00122779	Sat	400	-	10 066 9210	756140
Dink Classic	200	04	10 066 9240	00122779	Sat C	400	-	10 066 9210	756140
Downtown I	200	10	10 066 9240	00122779	Sat S	400	-	10 066 9210	756140
Like I	200	09	10 066 9240	00122779	Sat Sc	400	-	10 066 9210	756140



MODELLO - MODEL	Cc	ANNI YEARS	CODICE RMS RMS CODE	RIF. ORIGINALE OEM NUMBER
Sat X	400	-	10 066 9210	756140
Sat Xn	400	-	10 066 9210	756140
Geo	500	-	10 066 9210	756140
Sat	500	-	10 066 9210	756140
Sat C	500	-	10 066 9210	756140
Sat S	500	-	10 066 9210	756140
Sat Sc	500	-	10 066 9210	756140
Sat X	500	-	10 066 9210	756140
PIAGGIO				
Fly 4T	50	05-07	10 066 9210	436438
Fly 4T & 25-30 Km/H	50	08-11	10 066 9210	436438
Fly 4T 2V	50	13	10 066 9210	436438
Fly 4T 2V 25-30Km-H	50	12-14	10 066 9210	436438
Fly 4T 4V	50	12-13	10 066 9200	843307
Fly 4T Motore Chn	50	06-07	10 066 9210	436438
Liberty 4T	50	00-02	10 066 9210	436438
Liberty 4T	50	05-08	10 066 9210	436438
Liberty 4T Delivery - Single	50	10-12	10 066 9210	436438
Liberty 4T Delivery Tnt	50	09	10 066 9210	436438
Liberty 4T Ptt - Double	50	09-12	10 066 9210	436438
Liberty 4T Ptt (Deu)	50	07-12	10 066 9210	436438
Liberty 4T Rst	50	04	10 066 9210	436438
Liberty 4T Sport	50	06-08	10 066 9210	436438
Liberty lget 4T 3V ie	50	15-16	10 066 9200	843307
Liberty Moc 4T & Elle	50	09-13	10 066 9210	436438
Vespa Et4	50	00-05	10 066 9210	436438
Vespa Lx 4T	50	05-08	10 066 9210	436438
Vespa Lx 4T- 4V	50	09-13	10 066 9200	843307
Vespa Lx 4T- 4V Touring	50	10-13	10 066 9200	843307
Vespa Primavera 4T- 4V	50	13-16	10 066 9200	843307
Vespa S 4T- 4V & College	50	08-12	10 066 9200	843307
Vespa Sprint 4T 4V	50	14-16	10 066 9200	843307
Zip 4T	50	00-13	10 066 9210	436438
Fly 4T	100	06-08	10 066 9210	436438
Free	100	02-03	10 066 9210	436438
Zip 4T	100	06-10	10 066 9210	436438
Beverly	125	01-03	10 066 9210	436438
Beverly Eu3	125	07-08	10 066 9210	436438
Beverly Eu3 Mic	125	07	10 066 9210	436438
Beverly Eu3 Sport	125	07-08	10 066 9210	436438
Beverly Rst	125	04-07	10 066 9210	436438
Beverly Rst 4T 4V ie Eu3	125	10-13	10 066 9210	436438
Beverly Tourer Eu3	125	07-10	10 066 9210	436438
Carnaby	125	07-10	10 066 9210	436438
Fly	125	05-07	10 066 9210	436438
Fly 4T 3V ie E3 Dt	125	13-15	10 066 9200	843307
Fly 4T 3V ie Eu3 Lem	125	12-13	10 066 9200	843307
Fly 4T 3V ie E3 Dt	125	13	10 066 9210	436438
Fly 4T 3V ie Eu3 Lem	125	12-13	10 066 9210	436438
Fly Eu3	125	07-11	10 066 9210	436438
Hexagon Gtx	125	00	10 066 9210	436438

MODELLO - MODEL	Cc	ANNI YEARS	CODICE RMS RMS CODE	RIF. ORIGINALE OEM NUMBER
Hexagon Lx4	125	98-99	10 066 9210	436438
Liberty 4T 3V ie E3	125	13-14	10 066 9200	843307
Liberty	125	98-02	10 066 9210	436438
Liberty 4T	125	06-07	10 066 9210	436438
Liberty 4T 2V Eu3	125	09-12	10 066 9210	436438
Liberty 4T 2V ie Ptt - Ita	125	12	10 066 9210	436438
Liberty 4T 3V ie E3	125	13-14	10 066 9210	436438
Liberty 4T Eu3	125	07-08	10 066 9210	436438
Liberty 4T Eu3 Delivery-Single	125	07-12	10 066 9210	436438
Liberty 4T Eu3 Delivery - Tnt	125	08-09	10 066 9210	436438
Liberty 4T Sport Eu3	125	06-08	10 066 9210	436438
Liberty lget 4T 3V ie	125	15-16	10 066 9200	843307
Liberty Rst	125	04-05	10 066 9210	436438
Liberty Rst Ptt	125	05-11	10 066 9210	436438
Liberty Sport	125	06	10 066 9210	436438
Medley 4T ie Abs	125	16	10 066 9200	843307
Mp3	125	06-08	10 066 9210	436438
Mp3 lbrido	125	09-10	10 066 9210	436438
Mp3 ie	125	08-09	10 066 9210	436438
Mp3 ie Touring	125	11-12	10 066 9210	436438
Mp3 Yourban ERL	125	11-12	10 066 9210	436438
Sfera	125	95-97	10 066 9210	436438
Skipper 4T	125	00-02	10 066 9210	436438
Super Hexagon Gtx 12	125	01-02	10 066 9210	436438
Typhoon 4T 2V Eu3	125	10-11	10 066 9210	436438
Vespa 946 4T 3V Abs (Aspirazione - Intake)	125	13-15	10 066 9200	843307
Vespa 946 4T 3V Abs (Scarico - Exhaust)	125	13-14	10 066 9210	436438
Vespa Et4	125	96-02	10 066 9210	436438
Vespa Granturismo	125	03-07	10 066 9210	436438
Vespa Granturismo Eu3	125	06-07	10 066 9210	436438
Vespa Gts 4T ie Super	125	09-14	10 066 9210	436438
Vespa Gts Eu3	125	07-12	10 066 9210	436438
Vespa Gtv	125	06-08	10 066 9210	436438
Vespa Gtv 4T Navy Eu3	125	08	10 066 9210	436438
Vespa Lx 4T 3V ie - Touring	125	12-13	10 066 9200	843307
Vespa Lx Primavera 4T 3V ie	125	13-16	10 066 9200	843307
Vespa Primavera 4T 3V lget Abs	125	16	10 066 9200	843307
Vespa S 4T 3V ie	125	12	10 066 9200	843307
Vespa Sprint 4T 3V ie	125	14-15	10 066 9200	843307
Vespa Sprint lget 4T 3V Abs	125	16	10 066 9200	843307
Liberty 4T 3V Lem	150	13-14	10 066 9200	843307
Liberty lget 4T 3V ie	150	15-16	10 066 9200	843307
Medley 4T ie Abs	150	16	10 066 9200	843307
Vespa Lx 4T 3V ie-Touring	150	12-13	10 066 9200	843307
Vespa Primavera 4T- 3V	150	13-16	10 066 9200	843307
Vespa Primavera 4T 3V lget Abs	150	16	10 066 9200	843307



PARAOLI VALVOLE

VALVES OIL SEALS

MODELLO - MODEL	Cc	ANNI YEARS	CODICE RMS RMS CODE	RIF. ORIGINALE OEM NUMBER
SUZUKI				
An S-Y	125	95-00	10 066 9280	09289-05011-000
Dr Sm K9-L0	125	09-10	10 066 9280	09289-05011-000
Gz Marauder K3-K4	125	03-04	10 066 9280	09289-05011-000
Gz Marauder K8-L0	125	08-10	10 066 9280	09289-05011-000
Rv Van Van K3-K7	125	03-07	10 066 9280	09289-05011-000
Rv Van Van K8-L0	125	08-10	10 066 9280	09289-05011-000
Rv Van Van L3	125	13	10 066 9280	09289-05011-000
Uc Epicuro X-K1	125	99-01	10 066 9280	09289-05011-000
Uh Burgman K2-K6	125	02-06	10 066 9280	09289-05011-000
Uh Burgman K7-L0	125	07-10	10 066 9280	09289-05011-000
Uh Burgman L1	125	11-12	10 066 9280	09289-05011-000
Uh Burgman L3	125	13	10 066 9280	09289-05011-000
Ux Sixteen K8-L0	125	08-10	10 066 9280	09289-05011-000
Ux Sixteen L1	125	11	10 066 9280	09289-05011-000
VI Intruder K5-K7	125	05-07	10 066 9250	09289-04002-000
VI Intruder Y-K1	125	00-01	10 066 9250	09289-04002-000
An T-Y	150	96-00	10 066 9280	09289-05011-000
Uc Epicuro X-K1	150	99-01	10 066 9280	09289-05011-000
Uh Burgman K2-K6	150	02-06	10 066 9280	09289-05011-000
Ux Sixteen K8-L0	150	08-10	10 066 9280	09289-05011-000
Ux Sixteen L1	150	11	10 066 9280	09289-05011-000
Uh Burgman K7-L0	200	07-10	10 066 9280	09289-05011-000
Uh Burgman L1	200	11-12	10 066 9280	09289-05011-000
Uh Burgman L3	200	13	10 066 9280	09289-05011-000
An Burgman K3-K6	250	03-06	10 066 9280	09289-05011-000
An Burgman W-K2	250	98-02	10 066 9280	09289-05011-000
Rm-Z K7-K9	250	07-09	10 066 9250	09289-04002-000
Rm-Z L0	250	10	10 066 9250	09289-04002-000
Rm-Z L1	250	11	10 066 9250	09289-04002-000
Rm-Z L2	250	12	10 066 9250	09289-04002-000
Rm-Z L3	250	13	10 066 9250	09289-04002-000
Rm-Z L4	250	14	10 066 9250	09289-04002-000
VL Intruder K5-K7	250	05-07	10 066 9250	09289-04002-000
VL Intruder Y-K1	250	00-01	10 066 9250	09289-04002-000
Dr S L-R	350	90-94	10 066 9280	09289-05011-000
Dr Se R-W	350	94-98	10 066 9280	09289-05011-000
An Burgman K3-K6	400	03-06	10 066 9280	09289-05011-000
An Burgman K7-L0	400	07-10	10 066 9250	09289-04002-000
An Burgman L1	400	11	10 066 9250	09289-04002-000
An Burgman L2	400	12	10 066 9250	09289-04002-000
An Burgman L3	400	13	10 066 9250	09289-04002-000
An Burgman L4	400	14	10 066 9250	09289-04002-000
An Burgman X-K2	400	99-02	10 066 9280	09289-05011-000
Dr-Z E K5-K7	400	05-07	10 066 9280	09289-05011-000
Dr-Z S K5-K9	400	05-09	10 066 9280	09289-05011-000
Dr-Z S Y-K4	400	00-04	10 066 9280	09289-05011-000
Dr-Z Sm K5-K9	400	05-09	10 066 9280	09289-05011-000
Dr-Z Y-K3	400	00-03	10 066 9280	09289-05011-000
Gsf Bandit M-P	400	91-93	10 066 9250	09289-04002-000
Lt-A F Kingquad 4X4 K8-L0	400	08-10	10 066 9280	09289-05011-000
Lt-A F Kingquad 4X4 L1	400	11	10 066 9280	09289-05011-000

MODELLO - MODEL	Cc	ANNI YEARS	CODICE RMS RMS CODE	RIF. ORIGINALE OEM NUMBER
Lt-F Kingquad Fs 4X2 K8-L0	400	08-10	10 066 9280	09289-05011-000
Lt-F Kingquad Fs 4X4 K8-L0	400	08-10	10 066 9280	09289-05011-000
Lt-F Kingquad Fs 4X4 L1	400	11	10 066 9280	09289-05011-000
Lt-F Kingquad Fs 4X4 L2	400	12	10 066 9280	09289-05011-000
Lt-Z Quadrsport K4-K7	400	04-07	10 066 9280	09289-05011-000
Lt-Z Quadrsport K8	400	08	10 066 9280	09289-05011-000
Lt-Z Quadrsport K9-L0	400	09-10	10 066 9280	09289-05011-000
Lt-Z Quadrsport L1	400	11	10 066 9280	09289-05011-000
Lt-Z Quadrsport L2	400	12	10 066 9280	09289-05011-000
Lt-A X Kingquad 4X4 K7-L0	450	07-10	10 066 9280	09289-05011-000
Rm-Z K5-K6	450	05-06	10 066 9280	09289-05011-000
Lt-A Kingquad X L2	500	12	10 066 9280	09289-05011-000
Lt-A Kingquad Xp K9-L0	500	09-10	10 066 9280	09289-05011-000
Lt-A Kingquad Xp L1	500	11	10 066 9280	09289-05011-000
Lt-A Kingquad Xp L2	500	12	10 066 9280	09289-05011-000
Lt-A F Vinson K4-K7	500	04-07	10 066 9280	09289-05011-000
Gsf Bandit S-W	600	95-98	10 066 9280	09289-05011-000
Gsf Bandit Y-K4	600	00-04	10 066 9280	09289-05011-000
Gsx F J-S	600	88-95	10 066 9280	09289-05011-000
Gsx F K4-K6	600	04-06	10 066 9280	09289-05011-000
Gsx Fw-K3	600	98-03	10 066 9280	09289-05011-000
Gsx-R K4-K5	600	04-05	10 066 9250	09289-04002-000
Gsx-R K6-K7	600	06-07	10 066 9250	09289-04002-000
Gsx-R K8-L0	600	08-10	10 066 9250	09289-04002-000
Gsx-R L1	600	11	10 066 9250	09289-04002-000
Gsx-R L2	600	12	10 066 9250	09289-04002-000
Gsx-R L3	600	13	10 066 9250	09289-04002-000
Gsx-R L4	600	14	10 066 9250	09289-04002-000
Gsx-R V-Y	600	97-00	10 066 9250	09289-04002-000
Rf R P-T	600	93-96	10 066 9250	09289-04002-000
An Burgman K3-K5	650	03-05	10 066 9250	09289-04002-000
An Burgman K6-L0	650	06-10	10 066 9250	09289-04002-000
An Burgman L1	650	11	10 066 9250	09289-04002-000
An Burgman L2	650	12	10 066 9250	09289-04002-000
An Burgman L3	650	13	10 066 9250	09289-04002-000
DL V-Strom Abs L4	650	14	10 066 9250	09289-04002-000
DL V-Strom K4-K6	650	04-06	10 066 9250	09289-04002-000
DL V-Strom K7-L0	650	07-10	10 066 9250	09289-04002-000
DL V-Strom L1	650	11	10 066 9250	09289-04002-000
DL V-Strom L2	650	12	10 066 9250	09289-04002-000
Gsf Bandit K5-K6	650	05-06	10 066 9280	09289-05011-000
Gsf Bandit K7-K8	650	07-08	10 066 9250	09289-04002-000
Gsf Bandit K9-L0	650	09-10	10 066 9250	09289-04002-000
Gsf Bandit L1	650	11	10 066 9250	09289-04002-000
Gsf Bandit L2	650	12	10 066 9250	09289-04002-000
Gsx F K8-L0	650	08-10	10 066 9250	09289-04002-000
Gsx F L1	650	11	10 066 9250	09289-04002-000
Gsx F L2	650	12	10 066 9250	09289-04002-000
Sfv Gladius K9-L0	650	09-10	10 066 9250	09289-04002-000
Sfv Gladius L1	650	11	10 066 9250	09289-04002-000
Sfv Gladius L2	650	12	10 066 9250	09289-04002-000
Sfv Gladius L3	650	13	10 066 9250	09289-04002-000
Sfv Gladius L4	650	14	10 066 9250	09289-04002-000
Sv K3-K7	650	03-07	10 066 9250	09289-04002-000
Sv K8-L0	650	08-10	10 066 9250	09289-04002-000



MODELLO - MODEL	Cc	ANNI YEARS	CODICE RMS RMS CODE	RIF. ORIGINALE OEM NUMBER
Sv X-K2	650	99-02	10 066 9250	09289-04002-000
Gsx F K4-K6	750	04-06	10 066 9280	09289-05011-000
Gsx F K-T	750	89-96	10 066 9280	09289-05011-000
Gsx F W-K3	750	98-03	10 066 9280	09289-05011-000
Gsx W-K1	750	98-01	10 066 9280	09289-05011-000
Gsx-R F-H	750	85-87	10 066 9280	09289-05011-000
Gsx-R J-L	750	88-90	10 066 9280	09289-05011-000
Gsx-R K4-K5	750	04-05	10 066 9250	09289-04002-000
Gsx-R K6-K7	750	06-07	10 066 9250	09289-04002-000
Gsx-R K8-L0	750	08-10	10 066 9250	09289-04002-000
Gsx-R L1	750	11	10 066 9250	09289-04002-000
Gsx-R L2	750	12	10 066 9250	09289-04002-000
Gsx-R L3	750	13	10 066 9250	09289-04002-000
Gsx-R L4	750	14	10 066 9250	09289-04002-000
Gsx-R M	750	91-91	10 066 9280	09289-05011-000
Gsx-R Sp R	750	94-94	10 066 9250	09289-04002-000
Gsx-R T-X	750	96-99	10 066 9250	09289-04002-000
Gsx-R W N-S	750	92-95	10 066 9250	09289-04002-000
Rf R R-T	900	94-96	10 066 9250	09289-04002-000
Gsx-R K5-K6	1000	05-06	10 066 9250	09289-04002-000
Gsx-R K7-K8	1000	07-08	10 066 9250	09289-04002-000
Gsx-R K9-L0	1000	09-10	10 066 9250	09289-04002-000
Gsx-R L1	1000	11	10 066 9250	09289-04002-000
Gsx-R L2	1000	12	10 066 9250	09289-04002-000
Gsx-R L3	1000	13	10 066 9250	09289-04002-000
Gsx-R L4	1000	14	10 066 9250	09289-04002-000
Gsx-R ZL4	1000	14	10 066 9250	09289-04002-000
Gsx F J-P	1100	88-93	10 066 9280	09289-05011-000
Gsx-R G-J	1100	86-88	10 066 9280	09289-05011-000
Gsx-R K-L	1100	89-90	10 066 9280	09289-05011-000
Gsx-R M-N	1100	91-92	10 066 9280	09289-05011-000
Gsx-R W P-T	1100	93-96	10 066 9250	09289-04002-000
Gsf Bandit K1-K5	1200	01-05	10 066 9280	09289-05011-000
Gsf Bandit K6	1200	06	10 066 9280	09289-05011-000
Gsf Bandit T-Y	1200	96-00	10 066 9280	09289-05011-000
Gsx X-K1	1200	99-01	10 066 9280	09289-05011-000
Gsf Bandit K7-L0	1250	07-10	10 066 9250	09289-04002-000
Gsf Bandit L1	1250	11	10 066 9250	09289-04002-000
Gsf S Bandit L1	1250	11	10 066 9250	09289-04002-000
Gsf S Bandit L2	1250	12	10 066 9250	09289-04002-000
Gsx Fa L0	1250	10	10 066 9250	09289-04002-000
Gsx Fa L1	1250	11	10 066 9250	09289-04002-000
Gsx Fa L2	1250	12	10 066 9250	09289-04002-000
Gsx Bk B-King K8-L0	1300	08-10	10 066 9280	09289-05011-000
Gsz R Hayabusa K4-K7	1300	04-07	10 066 9280	09289-05011-000
Gsz R Hayabusa K8-L0	1300	08-10	10 066 9280	09289-05011-000
Gsz R Hayabusa L1	1300	11	10 066 9280	09289-05011-000
Gsz R Hayabusa L2	1300	12	10 066 9280	09289-05011-000
Gsz R Hayabusa X-K3	1300	99-03	10 066 9280	09289-05011-000
Gsz Ra Hayabusa L3	1300	13	10 066 9280	09289-05011-000
Gsz Ra Hayabusa L4	1300	14	10 066 9280	09289-05011-000

MODELLO - MODEL	Cc	ANNI YEARS	CODICE RMS RMS CODE	RIF. ORIGINALE OEM NUMBER
Gsx K2-K5	1400	02-05	10 066 9250	09289-04002-000
Gsx K6-K7	1400	06-07	10 066 9250	09289-04002-000
SYM				
Fiddle Li S	50	09-13	10 066 9290	12209H6B900
Jet4	50	09-10	10 066 9290	12209H6B900
Mio	50	06-07	10 066 9290	12209H6B900
Mio	50	09	10 066 9290	12209H6B900
Simply Li	50	14	10 066 9290	12209H6B900
Symphony	50	09	10 066 9290	12209H6B900
Symphony S	50	10-12	10 066 9290	12209H6B900
Symphony Sr	50	11-12	10 066 9290	12209H6B900
Symply Li	50	09	10 066 9290	12209H6B900
X Pro	50	13	10 066 9290	12209H6B900
Mio Eu2	100	05-06	10 066 9290	12209H6B900
Mio Eu3	100	07-08	10 066 9290	12209H6B900
Fiddle II	125	10-13	10 066 9290	12209H6B900
Fiddle III	125	14	10 066 9290	12209H6B900
Gts Joymax	125	06-07	10 066 9290	12209H6B900
Hd Eu2	125	03-04	10 066 9290	12209H6B900
Hd Eu3	125	07-08	10 066 9290	12209H6B900
Hd Evo	125	05-06	10 066 9290	12209H6B900
Hd Evo Eu3	125	07-08	10 066 9290	12209H6B900
Hd Evo Eu3	125	10-11	10 066 9290	12209H6B900
Hd Evo Tamburo Eu3	125	08-09	10 066 9290	12209H6B900
Hd2	125	11	10 066 9290	12209H6B900
Hd2	125	14	10 066 9290	12209H6B900
Jet V	125	11	10 066 9290	12209H6B900
Jet4	125	09-10	10 066 9290	12209H6B900
Joyride Eu2	125	03-04	10 066 9290	12209H6B900
Joyride Eu2	125	05-06	10 066 9290	12209H6B900
Joyride Evo	125	09-10	10 066 9290	12209H6B900
Joyride Eu3	125	07	10 066 9290	12209H6B900
Joyride Evo	125	10	10 066 9290	12209H6B900
Joyride Evo	125	13-14	10 066 9290	12209H6B900
Megalo	125	06-07	10 066 9290	12209H6B900
Megalo	125	06-07	10 066 9290	12209H6B900
Symphony	125	09	10 066 9290	12209H6B900
Symphony S	125	09-10	10 066 9290	12209H6B900
Symphony S	125	12-14	10 066 9290	12209H6B900
Symphony Sr	125	10	10 066 9290	12209H6B900
Symphony Sr	125	12	10 066 9290	12209H6B900
Symply II	125	14	10 066 9290	12209H6B900
Vs	125	06	10 066 9290	12209H6B900
Vs	125	06	10 066 9290	12209H6B900
Vs Eu3	125	07-08	10 066 9290	12209H6B900
Vs Eu3	125	07-08	10 066 9290	12209H6B900
X Pro	125	13	10 066 9290	12209H6B900
Fiddle II	150	10	10 066 9290	12209H6B900
Fiddle II	150	12	10 066 9290	12209H6B900
Joyride	150	01-02	10 066 9290	12209H6B900
Symphony S	150	09-10	10 066 9290	12209H6B900



PARAOLI VALVOLE VALVES OIL SEALS

MODELLO - MODEL	Cc	ANNI YEARS	CODICE RMS RMS CODE	RIF. ORIGINALE OEM NUMBER	MODELLO - MODEL	Cc	ANNI YEARS	CODICE RMS RMS CODE	RIF. ORIGINALE OEM NUMBER
Symphony S	150	12-14	10 066 9290	12209H6B900	Tw	125	03	10 066 9220	5H0121190000
Symphony Sr	150	10	10 066 9290	12209H6B900	Vp X- City	125	08-11	10 066 9300	5YPE21190000
Symphony Sr	150	12	10 066 9290	12209H6B900	Wr R	125	09-11	10 066 9300	5YPE21190000
Vs	150	06	10 066 9290	12209H6B900	Wr X	125	09-11	10 066 9300	5YPE21190000
Vs	150	06	10 066 9290	12209H6B900	Wr X	125	13	10 066 9300	5YPE21190000
Vs Eu3	150	07-08	10 066 9290	12209H6B900	Xc Cygnus R	125	99-99	10 066 9300	4TE121190000
Vs Eu3	150	07-08	10 066 9290	12209H6B900	Xc Cygnus R	125	00-03	10 066 9300	4TE121190000
Track Runner	180	06-07	10 066 9290	12209H6B900	Xc R Majesty S	125	14	10 066 9250	52SE21190000
Track Runner	180	06-07	10 066 9290	12209H6B900	Xn Teo' S	125	00	10 066 9300	4TE121190000
Hd Eu2	200	03-04	10 066 9290	12209H6B900	Xq Maxster	125	01-02	10 066 9300	4TE121190000
Hd Eu3 I	200	07	10 066 9290	12209H6B900	Yp Majesty	125	98-02	10 066 9300	4TE121190000
Hd Evo Eu2	200	05-06	10 066 9290	12209H6B900	Yp E Majesty	125	03-09	10 066 9300	4TE121190000
Hd Evo Eu3 I	200	07	10 066 9290	12209H6B900	Yp R X- Max	125	06-12	10 066 9300	5YPE21190000
Hd Evo I Eu3	200	10-12	10 066 9290	12209H6B900	Yp R X- Max	125	12-13	10 066 9300	5YPE21190000
Hd Evo I Tamburo Eu3	200	08-09	10 066 9290	12209H6B900	Yp R X- Max Abs	125	11	10 066 9300	5YPE21190000
Hd2 I	200	11	10 066 9290	12209H6B900	Yp Ra X- Max Abs	125	13	10 066 9300	5YPE21190000
Hd2 I	200	14	10 066 9290	12209H6B900	Yzf- R	125	08-13	10 066 9300	5YPE21190000
Joyride	200	03	10 066 9290	12209H6B900	Hw Xenter	150	12	10 066 9250	52SE21190000
Joyride Eu2	200	03-04	10 066 9290	12209H6B900	Xn Teo' S	150	01-02	10 066 9300	4TE121190000
Joyride Eu2	200	05-06	10 066 9290	12209H6B900	Xq Maxster	150	01-02	10 066 9300	4TE121190000
Joyride Evo I	200	09	10 066 9290	12209H6B900	Yp Majesty	150	00-02	10 066 9300	4TE121190000
Joyride Evo I	200	13	10 066 9290	12209H6B900	Yp E Majesty	180	03-06	10 066 9300	4TE121190000
Joyride I Eu3	200	07-09	10 066 9290	12209H6B900	Tw	200	94-94	10 066 9220	5H0121190000
Joyride I Evo	200	10	10 066 9290	12209H6B900	Vp X- City	250	07-13	10 066 9220	5H0121190000
Gts	250	07-08	10 066 9290	12209H6B900	Wr F	250	01-11	10 066 9320	4TV121190000
Gts	250	07-08	10 066 9290	12209H6B900	Wr R	250	08	10 066 9300	4TE121190000
Joymax	250	05-07	10 066 9290	12209H6B900	Wr R	250	13	10 066 9300	4TE121190000
Joymax Eu3 I	250	07-08	10 066 9290	12209H6B900	Wr X	250	08	10 066 9300	4TE121190000
Quad Lander	250	06-07	10 066 9290	12209H6B900	Xg Tricker	250	05	10 066 9220	5H0121190000
Sb Ni	250	12	10 066 9290	12209H6B900	Ybr	250	07-11	10 066 9220	5H0121190000
Citycom	300	08-09	10 066 9290	12209H6B900	Yp Majesty	250	96-98	10 066 9220	5H0121190000
Citycom Efi	300	10-11	10 066 9290	12209H6B900	Yp Majesty	250	00-03	10 066 9220	5H0121190000
Citycom I Cbs	300	12	10 066 9290	12209H6B900	Yp Majesty Abs	250	03	10 066 9220	5H0121190000
Joymax Evo	300	09	10 066 9290	12209H6B900	Yp Majesty Dx	250	98-99	10 066 9220	5H0121190000
Joymax Evo I	300	10	10 066 9290	12209H6B900	Yp R Black X- Max	250	09	10 066 9220	5H0121190000
Joymax I	300	12	10 066 9290	12209H6B900	Yp R X- Max	250	05-12	10 066 9220	5H0121190000
Joymax I	300	14	10 066 9290	12209H6B900	Yp R X- Max	250	12-14	10 066 9220	5H0121190000
Joymax I Abs	300	13-14	10 066 9290	12209H6B900	Yp R X- Max Sport	250	11-12	10 066 9220	5H0121190000
Quad Lander	300	08	10 066 9290	12209H6B900	Yp Ra X- Max Abs	250	12-14	10 066 9220	5H0121190000
Quad Lander S	300	07-08	10 066 9290	12209H6B900	Yz F	250	01-14	10 066 9300	4TE121190000
Maxsym I	400	11-12	10 066 9290	12209H6B900	Xc Versity	300	03-06	10 066 9220	5H0121190000
Maxsym I Abs	400	12	10 066 9290	12209H6B900	Yp Majesty	400	07-11	10 066 9310	3P6121290000
Quad Raider	600	08	10 066 9290	12209H6B900	Yp Majesty Abs	400	07-11	10 066 9310	3P6121290000
YAMAHA					Yp X- Max	400	13-14	10 066 9310	3P6121290000
Xf Gi Ggle	50	08	10 066 9270	5STE21190000	Yp Ra X- Max Abs	400	14	10 066 9310	3P6121290000
Yn F Neo' S 4	50	09-12	10 066 9270	5STE21190000	Xp T-Max	500	01-11	10 066 9320	4TV121190000
Yn F Neo' S 4	50	12-14	10 066 9270	5STE21190000	Xp T-Max Abs	500	05-11	10 066 9320	4TV121190000
Hw Xenter	125	12	10 066 9250	52SE21190000	Xp T-Max Abs Sv	500	11	10 066 9320	4TV121190000
Sr	125	99-00	10 066 9220	5H0121190000	Xp T-Max Black Max	500	06	10 066 9320	4TV121190000
Tw	125	99-01	10 066 9220	5H0121190000	XpT-MaxBlackMax-NightMax	500	07	10 066 9320	4TV121190000
					Xp T-Max Sv	500	11	10 066 9320	4TV121190000



MODELLO - MODEL	Cc	ANNI YEARS	CODICE RMS RMS CODE	RIF. ORIGINALE OEM NUMBER	MODELLO - MODEL	Cc	ANNI YEARS	CODICE RMS RMS CODE	RIF. ORIGINALE OEM NUMBER
Xp T-Max White Max	500	10	10 066 9320	4TV121190000	Yzf R1 (Scarico - Exhaust)	1000	11	10 066 9300	4TE121190000
Xp T-Max	530	12-14	10 066 9320	4TV121190000	Yzf R1 (Aspirazione - Intake)	1000	11	10 066 9310	3P6121290000
Xp T-Max Abs	530	12-14	10 066 9320	4TV121190000	Yzf R1 (Scarico - Exhaust)	1000	12	10 066 9300	4TE121190000
Fz6	600	04-07	10 066 9320	4TV121190000	Yzf R1 (Aspirazione - Intake)	1000	12	10 066 9310	3P6121290000
Fz6 Fazer	600	04-07	10 066 9320	4TV121190000	Yzf R1 (Scarico - Exhaust)	1000	13-14	10 066 9300	4TE121190000
Fz6 Fazer Abs	600	06-07	10 066 9320	4TV121190000	Yzf R1 (Aspirazione - Intake)	1000	13-14	10 066 9310	3P6121290000
Fz6 Fazer S2	600	07-08	10 066 9320	4TV121190000	Yzf-R1 Sp	1000	06	10 066 9320	4TV121190000
Fz6 Fazer S2 Abs	600	08	10 066 9320	4TV121190000	Fjr A Abs	1300	06-08	10 066 9310	3P6121290000
Fz6 Ns	600	05-06	10 066 9320	4TV121190000	Fjr A Abs	1300	10-11	10 066 9310	3P6121290000
Fz6 S2	600	07-08	10 066 9320	4TV121190000	Fjr A Abs	1300	13-14	10 066 9310	3P6121290000
Fzr R	600	94-95	10 066 9320	4TV121190000	Fjr Ae	1300	14	10 066 9310	3P6121290000
Fzs Fazer	600	98-99	10 066 9320	4TV121190000	Fjr As	1300	06-08	10 066 9310	3P6121290000
Fzs Fazer	600	02-03	10 066 9320	4TV121190000	Xvs Cu Custom	1300	14	10 066 9220	5H0121190000
Fzs Fazer (Fzs S)	600	00-01	10 066 9320	4TV121190000	V- Max	1700	09-12	10 066 9310	3P6121290000
Xj6-F Diversion	600	10-11	10 066 9320	4TV121190000					
Xj6-Fa Diversion Abs	600	11	10 066 9320	4TV121190000					
Xj6-N	600	09-11	10 066 9320	4TV121190000					
Xj6-N	600	13	10 066 9320	4TV121190000					
Xj6-N Sp	600	13	10 066 9320	4TV121190000					
Xj6-Na Abs	600	13	10 066 9320	4TV121190000					
Xj6-S Diversion	600	09-11	10 066 9320	4TV121190000					
Xj6-S Diversion	600	13	10 066 9320	4TV121190000					
Yzf R Thunder Cat	600	96-99	10 066 9320	4TV121190000					
Yzf R Thunder Cat	600	00-02	10 066 9320	4TV121190000					
Yzf R46	600	05	10 066 9320	4TV121190000					
Yzf R6	600	99-05	10 066 9320	4TV121190000					
Mt- 03	660	06-11	10 066 9220	5H0121190000					
Szr	660	95-97	10 066 9220	5H0121190000					
Xt R	660	04-11	10 066 9220	5H0121190000					
Xt R	660	14	10 066 9220	5H0121190000					
Xt X	660	04-11	10 066 9220	5H0121190000					
Xt X	660	14	10 066 9220	5H0121190000					
Xt Z Tenere	660	91-96	10 066 9220	5H0121190000					
Xt Z Tenere	660	08-13	10 066 9220	5H0121190000					
Mt- 07	700	14	10 066 9300	4TE121190000					
Mt- 09	850	14	10 066 9300	4TE121190000					
Xv	950	14	10 066 9220	5H0121190000					
Xv Abs	950	14	10 066 9220	5H0121190000					
Xv R Abs	950	14	10 066 9220	5H0121190000					
Fz1	1000	06-09	10 066 9320	4TV121190000					
Fz1 Fazer	1000	06-12	10 066 9320	4TV121190000					
Fz1 Fazer Abs	1000	11-12	10 066 9320	4TV121190000					
Fz1-N	1000	11	10 066 9320	4TV121190000					
Fz1-Na	1000	10-11	10 066 9320	4TV121190000					
Fzs Fazer	1000	01-05	10 066 9320	4TV121190000					
Yzf R1	1000	98-06	10 066 9320	4TV121190000					
Yzf R1	1000	07-08	10 066 9310	3P6121290000					
Yzf R1 (Scarico-Exhaust)	1000	09	10 066 9300	4TE121190000					
Yzf R1 (Aspirazione - Intake)	1000	09	10 066 9310	3P6121290000					
Yzf R1 (Scarico - Exhaust)	1000	10	10 066 9300	4TE121190000					
Yzf R1 (Aspirazione - Intake)	1000	10	10 066 9310	3P6121290000					



PATTINI CATENA DISTRIBUZIONE
TIMING CHAIN GUIDES

16 371 4010



KIT PATTINI CATENA DISTRIBUZIONE
TIMING CHAIN GUIDES KIT

KYMCO 125: B&w Eu2 03-04 • B&w 00 • Dink Eu3 06-07 • Dink 97-98 • Dink Classic Eu2 03 • Dink Classic 02 • Dink Lx 98-00 • Gran Dink Eu2 03-04 • Gran Dink 01-02 • **200:** Dink Classic 04 • Dink Eu3 I 06-07 • (R.O. 00123913-00123914)



16 371 4020



KIT PATTINI CATENA DISTRIBUZIONE
TIMING CHAIN GUIDES KIT

KYMCO 125: Downtown I 09 • K-Xct I 12-14 • People Gti 10-14 • (R.O. 00114104-00114105)



16 371 4030



KIT PATTINI CATENA DISTRIBUZIONE
TIMING CHAIN GUIDES KIT

KYMCO 200: Downtown I 10 • People Gti 10-14 • **300:** Downtown I 09 • Downtown Abs I 11 • Downtown Abs 10 • Downtown I 11 • K-Xct I Abs 14 • K-Xct I 12 • People Gti Abs 12-14 • People Gti 10-14 • **350:** Downtown I Abs 15 • **400:** X Citing I Abs 14-15 • X Citing I 13-15 (R.O. 00114090-00114091)



16 371 4040



KIT PATTINI CATENA DISTRIBUZIONE
TIMING CHAIN GUIDES KIT

KYMCO 50: Agility 4T Carry 11 • Agility 4T R10 06-08 • Agility R12 07-08 • Agility R16 08-12 • Agility Plus 4T 14 • Agility R12 05 • Agility Rs 09 • Dink 4T 07 • Filly Lx 01-02 • Filly 98-00 • Like 4T 01-02 • People S 4T 06-08 • Sento 08 • Super 8 4T 09-13 • Super 8 07 • Vitality 4T 04 (R.O. 00103613-00103614)



16 371 4050



KIT PATTINI CATENA DISTRIBUZIONE
TIMING CHAIN GUIDES KIT

KYMCO 250: B&w Eu2 03 • B&w 00 • Grand Dink Eu2 03-04 • Grand Dink 01-02 • Kxr 03-04 • Mxu 05 • People Lc 03-04 • People S I 07 • People S 06 • X Citing I 06-07 • X Citing 05 • Yup 03 (R.O. 00123911-00123917)



16 371 4060



KIT PATTINI CATENA DISTRIBUZIONE
TIMING CHAIN GUIDES KIT

KYMCO 125: Agility 4T Eu3 06-08 • Agility 4T 06 • Agility Carry 11 • Agility Plus 14 • Agility R16 08-12 • Agility bRs 09 • Like Lx 12 • Like 09 • Movie Eu3 06-07 • Movie XL Eu2 03-04 • Movie XL 01 • Movie 99-00 • People Eu2 03 • People 99-00 • People Eu3 07-11 • People One I Dd 15 • People One I 13 • People S Dd Eu3 07-08 • People S 05 • Super 8 08-09 • Vivio 00 • **200:** Agility R16 08-09 • Movie Eu3 06-07 • **200:** Agility I R16 10 • Agility I Plus 14 • Agility R16 12 • Like I 09 • Like Lx 12 • People S I 07 • People S 05 - (R.O. 00123111-00123112)



16 371 4070



KIT PATTINI CATENA DISTRIBUZIONE
TIMING CHAIN GUIDES KIT

KYMCO 500: X Citing R 09 • X Citing I R 07-08 • X Citing I 06-08 • X Citing 05 (R.O. 00123060-00122047)



16 371 4080



KIT PATTINI CATENA DISTRIBUZIONE
TIMING CHAIN GUIDES KIT

KYMCO 300: G-Dink 12 • Maxxer 05-06 • Mxu R 10 • Mxu 05-06 • People S I 08 • X Citing I R 08-09 • X Citing I 08 (R.O. 00123095-00123096)



▶ GUARNIZIONI

GASKET SETS



SERIE GUARNIZIONI MOTORE
ENGINE GASKET SETS

APRILIA

10 068 0010

50: Amico 90-96



10 068 0040

50: Ditech
(Iniezione e carburatore - *Injection and carburator*)



10 068 1200

50: Mojito Custom 2T Motore Piaggio 04-10



10 068 0050

50: Rs moto



10 068 0070

50: SR • Scarabeo • Rally • Gulliver



10 068 4200

50: Scarabeo 4T 4V 10-14 • Scarabeo Quattro 09 •
Scarabeo 4T 4V Net 09-10 • Sr Motard 4T 4V 13-14



10 068 4260

50: Scarabeo 4T 02-06 • 100: Scarabeo 4T 01-05



10 068 9180

50: Scarabeo • Ditech 01-03

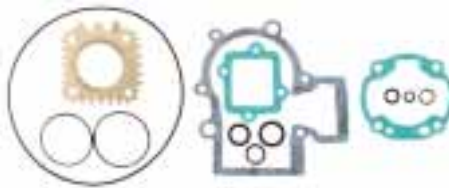

10 068 4230

125: Atlantic 03-05 • Scarabeo 03-06



10 068 9190

125: Leonardo 96-01



10 068 4240

125: Mojito 03-07



10 068 4210

125: Mojito 08 • Sport City One 4T Eu3 08-11 • Sr
Motard 12-14

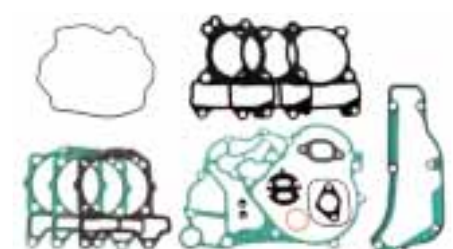

10 068 9210

125: Scarabeo Gt 99-02



10 068 9200

150: Leonardo 96-01



10 068 9220

10 068 9221

150: Scarabeo 99-02





APRILIA

10 068 9550 

250: Atlantic Eu3 06-08
• Scarabeo Light 06-08



10 068 9160 

250: Leonardo 99-01



10 068 4220 



250: Sport City Cube 08-12
300: Atlantic 10-11 • Scarabeo Light 09-10 •
Sport City Street 11-14

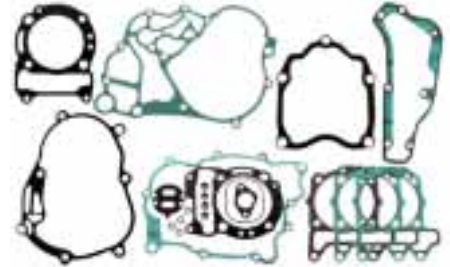

10 068 9410 

500: Atlantic 02-04 • Scarabeo 03-04



ATALA

10 068 0830 

50: Hacker



BENELLI

10 068 9160 

250: Velvet



BETA

10 068 9290 

125: Eikon 99-02



10 068 9300 

150: Eikon 99-02



DERBI

10 068 4260 



50-100: Atlantis 4T 04-06



10 068 4240 



125-150: Boulevard 02-04



10 068 4210 



125: Boulevard 03-07 • Boulevard 4T Eu3 08-12
• Sonar 4T 09-11 • Variant Sport 4T Eu3 12
150: Boulevard 03-07 • Boulevard 4T Eu3 10
• Sonar 4T 09
200: Boulevard Eu2 05-06

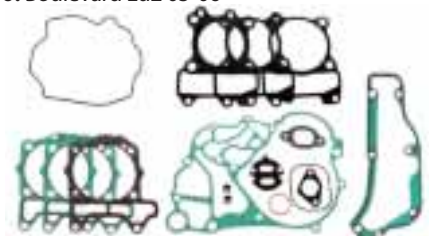



SERIE GUARNIZIONI MOTORE
ENGINE GASKET SETS

DERBI

10 068 4230 



125: Gp1 06-08

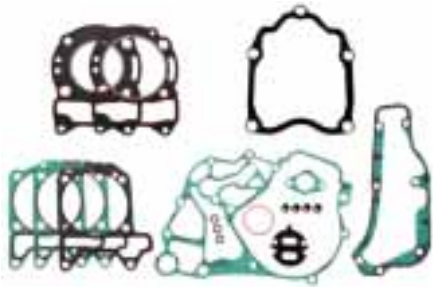

10 068 4220 



250: Gp1 06-08
300: Rambla 10-11

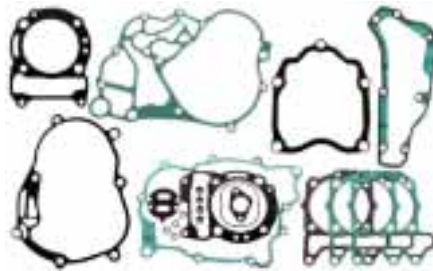

F. MORINI

10 068 0830 

50: AHL 94-95
(Raffreddato aria - *Air cooled*)



10 068 9370 

50: H2
(Carter Lungo - *Long Crankcase*)



GILERA

10 068 1200 

50: Typhoon • Storm • Easy moving



10 068 9400 

125: Dna 01 • Runner Vx • Race • Sc 00-07



10 068 9380 

180: Runner Sp Fxr 97-02



10 068 9381 



10 068 9390 

180: Dna 01 • Runner Vxr 00-01



HONDA

10 068 3500 

50: Vision 1° serie 85-87

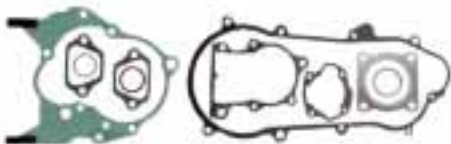

10 068 9830 

125: Pcx 10-15



10 068 9080 

125: Sh • Chiocciola • Dylan 00-01





HONDA

10 068 9230 

125: Pantheon 98-02



10 068 9241 

150: Pantheon 98-01



10 068 9090 

150: Sh



10 068 9251 

250: Fes • Foresight 98-99



10 068 9260 

250: Jazz 01



10 068 9560 

10 068 9561 



300: Sh 300



ITALJET

10 068 0830 

50: Formula



10 068 9380 

10 068 9381 



180: Dragster 99-00

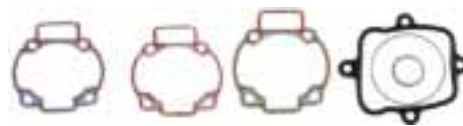

KYMCO

10 068 4270 

50: Agility 4T Carry 11 • Agility 4T R10 06-08 •
Agility 4T R16 08-12 • Agility Plus 4T 14 • Agility
R12 05 • Agility Rs 09 • Dink 4T 07 • Filly 98-00 •
Filly Rx 01-02 • Like 4T 09 • People S 4T 06-08 •
Sento 08 • Super 8 07-13 • Vitality 4T 04

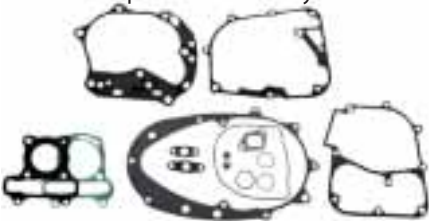

10 068 9680 

50: Agility R16 08-12



10 068 9270 

50: Dink
(Raffreddato aria - *Air cooled*)

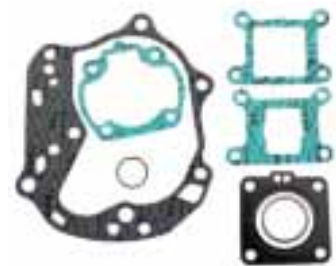

10 068 9280 

50: Dink LC
(Raffreddato liquido - *Liquid cooled*)



10 068 9690 

125: Agility R16 08-12



10 068 9350 

125: B&W 00 • Dink Lx 98-00 • Dink Classic
02-03

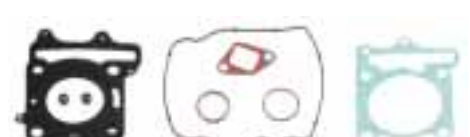



SERIE GUARNIZIONI MOTORE
ENGINE GASKET SETS

KYMCO

10 068 9290 

125: Dink 97-98



10 068 9330 

125: People 99-00



10 068 9700 

150: Agility R16 08-11



10 068 9360 

150: B&W 00 • Dink Classic 02-03 • Dink Lx 98-00

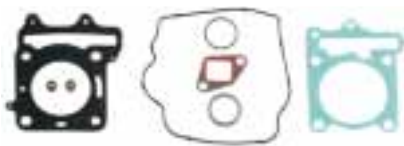

10 068 9300 

150: Dink 97-98



10 068 9340 

150: People 99-00



10 068 9710 

200: Agility R16 10-12



10 068 4290 

200: Downtown I 10 • People Gti 10-14
300: Downtown I 09-11 • K-Xct i 12-14 • People Gti 10-14

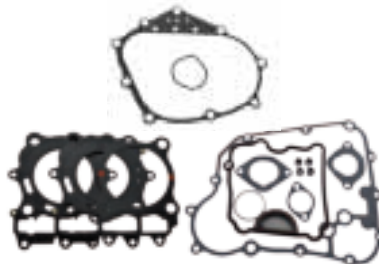

10 068 4280 

250: B&W 00-03 • Gran Dink 01-04 • People Lc 03-04 • People S 06-07 • X Citing 05-07 • Yup 03
300: People S 08 • X Citing 08 • X Citing I R 08-09



10 068 9310 

250: Grand Dink



MALAGUTI

10 068 2500 

50: F 10 Yesterday 92-95
(Raffreddato aria - Air cooled)



10 068 0070 

50: F12 • F15 • Centro



10 068 9320 

100: Ciak • F12 Phantom





MALAGUTI

10 068 9330

125: Ciak 00-01



10 068 9350

125: F18 Warrior 00-01



10 068 9140

125: Madison 99



10 068 9340

150: Ciak 00-01



10 068 9360

150: F18 Warrior 00-01



10 068 9160

250: Madison 99-01



MBK

10 068 0010

50: Booster 90-95



10 068 3000

50: CT S Sorriso 90-93



10 068 2500

50: Evolis 93-96



10 068 0070

50: Nitro • Ovetto



10 068 9140

125: Doodo 00-01 • Thunder • Skyliner 00-02



10 068 9160

250: Skyliner 00-01



MINARELLI

10 068 0080

50: Am6 II Serie - New Model





SERIE GUARNIZIONI MOTORE
ENGINE GASKET SETS

PEUGEOT

10 068 3520

50: Buxy • Speedake • Squab 94-95



10 068 3500

50: ST • STL • STL2 Rapido • Rapido 3 85-93

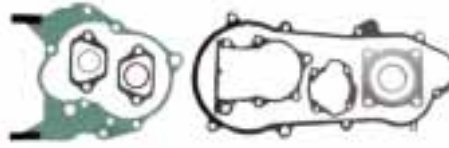

10 068 9420

100: Trekker • Sv • Elyseo



PIAGGIO

10 068 6500

50: Ape TM 50 P
(Confezione 5 pezzi - 5 pcs pack)

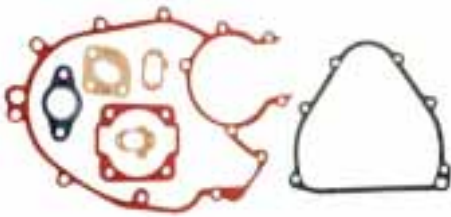

10 068 4000

50: Ciao • Si • Bravo • Grillo • Boxer 70-93
(Confezione 5 pezzi - 5 pcs pack)



10 068 1200

50: Diesis 01 • Free Delivery 00-01 • Free FL 95-02 • Free 92-94 • Nrg extreme 99-00 • Nrg Mc3 01-04 • Nrg power Dt 06-11 • Sfera Maquillage 2 94 • Sfera Rst 95-97 • Sfera 91-93 • Typhoon 01-08 • Vespa Et2 97-05 • Vespa Lx 2T 09-13 • Zip Fast Raider Rst 96-97 • Zip Fast Raider 93-94 • Zip Rst 96-99 • Zip 92-04
80: Skr City



10 068 9101 **NEW**

50: Fly 4T 2V 25-30 Km/h 12 • Fly 4T 05-07 • Liberty 4T Delivery • Single 10-12 • Liberty 4T Delivery Tnt 09 • Liberty 4T Ptt (Deu) 07-12 • Liberty 4T Ptt • Double 09-12 • Liberty 4T Rst 04 • Liberty 4T Sport 07-08 • Liberty 4T 00-08 • Liberty Moc 4T & Elle 09-13 • Vespa Et4 00-05 • Vespa Lx 4T 05-08 • Zip 4T 00-13



10 068 4200 **NEW**

50: Fly 4T 4V 12-13 • Vespa Lx 4T 4V 09-13 • Vespa Primavera 4T 4V 13-15 • Vespa S 4T 4V 08-12 • Vespa Sprint 4T 4V 14



10 068 4260 **NEW**

50: Liberty 4T 00-02 • Liberty 4T Rst 04 • Vespa Et4 00-05 • Zip 4T 00-05
100: Free 00-02

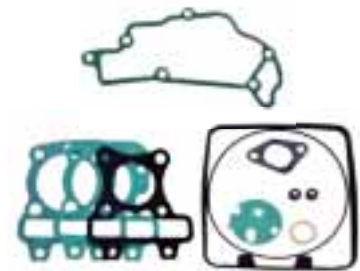

10 068 4020

50: NRG • NTT 95-96



10 068 4010

50: Quartz 92-93



10 068 4050

50: Vespa PK XL Rush
(Confezione 10 pezzi - 10 pcs pack)
(R.O. 154616)





PIAGGIO

10 068 4040 

50-90-125: Vespa Primavera ET3-125 modello 66-84
(Confezione 10 pezzi - 10 pcs pack)
(R.O. 091925)



10 068 4230  

125: Beverly Rst 04-07 • Vespa Gran Turismo 03-07 • Vespa Gtv 06-08 • X8 04-06 • X8 Premium Eu2 06 • X9 Evolution 03-06
200: Vespa Gran Turismo 06-07 • X8 05-07 • X9 02-03 • X9 Evolution 03



10 068 4240  

125: Beverly 01-05 • Fly Eu3 07 • Liberty 01-05 • Skipper 4T 00-02 • Super Hexagon Gtx 12 01-02 • Vespa Et4 99-02 • Vespa Gran Turismo 03-05 • X8 04-06 • X9 Evolution 03 • X9 01-02 • Zip 00-02 • X9 Amalfi 00-03
200: Liberty Rst 04 • X9 Evolution 03 • X9 02-03 • Carnaby 07-08 • Vespa Gran Turismo 06-07 • X8 05-07



10 068 9490 

125-200: Beverly 01-02



10 068 4110 

125-150: Cosa CL-CLX 88-91 • Cosa 2 91-97 • Vespa Pxe Arcob. 81-97 • Vespa PX 98-01
(Confezione 5 pezzi - 5 pcs pack)
(Con Miscelatore - With mixer)
(R.O. 154546)



10 068 4210  

125: Fly 05-07 • Fly Eu3 07-11 • Liberty 4T 01-11 • Liberty 4T Eu3 06-15 • Liberty 4T 2V 09-12 • Skipper 4T 00-02 • Typhoon 4T 2V Eu3 10-11 • Vespa Et4 99-02 • Vespa Lx 05-11 • Vespa Lxv 06-13 • Vespa S 07-11 • X8 Street Eu2 06-07 • Zip 00-02
150: Fly 05-08 • Liberty 4T Eu3 08-13 • Vespa Lx 09-12 • Vespa S 4T 09-12 • X8 Street Eu2 06-08
200: Liberty 4T 06-08 • Liberty Rst 04 • Liberty Sport 06 • Liberty 06

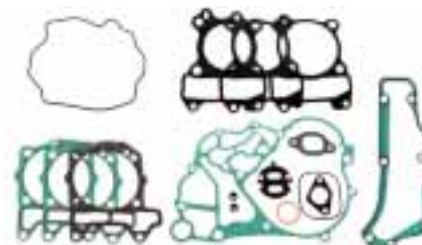

10 068 4250  

125: Fly 4T 3V le 12-15 • Liberty 4T 3V le 13-14 • Vespa 946 4T 3V 13-14 • Vespa Lx 4T 4V 12-13 • Vespa Lx Primavera 4T 3V 13-14 • Vespa S 4T 3V 12 • Vespa Sprint 4T 3V 14-15
150: Liberty 4T 3V 13-14 • Vespa Gts Super le 4T 3V 14-15 • Vespa Lt 4T 3V 14 • Vespa Lx 4T 3V le 12-13 • Vespa Primavera 4T 3V 13-14 • Vespa Sprint 4T 3V le 15

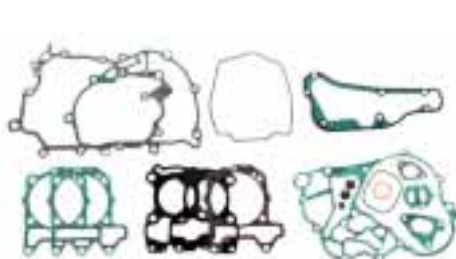

10 068 9780 

125: Hexagon Lx4 98-99 • Liberty 98-00 • Sfera 95-97 • Vespa Et4 96-98



10 068 4030 

10 068 4031  

125-150: Hexagon 94-96

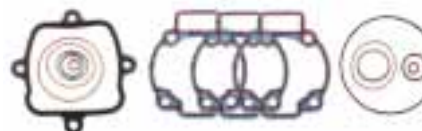



PIAGGIO

10 068 9110 

125-150: Liberty



10 068 9400 

125: Super Hexagon Gtx 00-02 • X9 01-02



10 068 4070 

125: Vespa T5 85-89
(Confezione 5 pezzi - 5 pcs pack)
(R.O. 154699)



10 068 4090 

125-150: Vespa PX • Vespa PXE Arcobaleno
Sprint 3° serie 78-93
(Confezione 10 pezzi - 10 pcs pack)
(R.O. 154563)

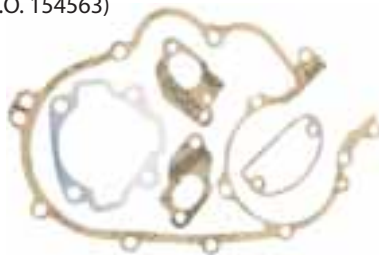

10 068 4130 

125-150: Vespa 1961
(R.O. 86684)



10 068 4140 

125-150: Vespa VNB1T-VNB2T
(R.O. 86686)



10 068 4160 

125: Vespa Granturismo VNL2T



10 068 4180 

125-150: Vespa Super VBC1T
(R.O. 91991)



10 068 4080 

150: Vespa GL Sprint
(Confezione 5 pezzi - 5 pcs pack)
(R.O. 091730)



10 068 4170 

150: Vespa Sprint VLB-VLA



10 068 4190 

150: Vespa Super GTR



10 068 4150 

160: Vespa GS VSB1T





PIAGGIO

10 068 9380 

10 068 9381 

180: Hexagon Lxt 97-99



10 068 9390 

180: Super Hexagon Gtx 00-02 • X9 Amalfi 00-03



10 068 4120 

200: Cosa 88-91 • Cosa 2 91-97 • Vespa Pxe Arcobaleno 81-97 • Vespa Px 98-01 (Con Miscelatore - With mixer)



10 068 4100 

200: Vespa PE • Vespa PX Arcobaleno Rally 84-93 (Confezione 5 pezzi - 5 pcs pack) (R.O. 154547)



10 068 6530 

220: Ape MP P501 - P601 (Confezione 5 pezzi - 5 pcs pack)



10 068 6540 

220: Ape TM 602 - TM 703 (Confezione 5 pezzi - 5 pcs pack)

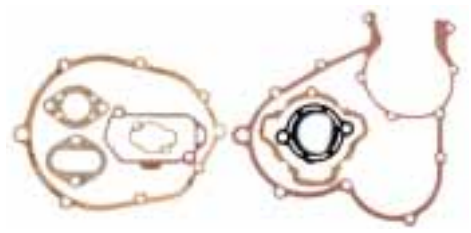

10 068 4220 

250: Beverly 04-09 • Carnaby 08 • Mp3 06-09 • Vespa Gts 05-14 • Vespa Gtv 07-09 • X Evo 07-13 • X7 Eu3 08 • X8 Eu3 05-08 • X9 Evolution 04-06
300: Beverly Rst 10-15 • Beverly Tourer Eu3 09-10 • Carnaby Cruiser 09-12 • Mp3 10-14 • Mp3 You-rban 11-15 • Vespa Gts 08-15 • Vespa Gtv 10-13 • X7 Evo Eu3 09-10

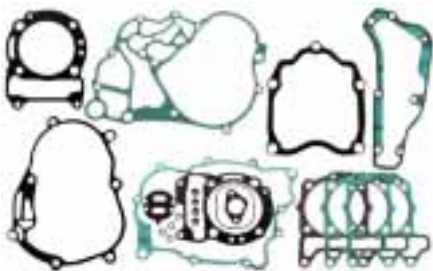

10 068 9550 

250: Beverly Cruiser 07-09 • Beverly Ie Eu3 06-08 • Beverly 06-07 • Beverly Rst 04-05 • Beverly Sport 06-08 • Beverly Tourer Eu3 08-09 • Carnaby 08 • Mp3 Lt 08-09 • Mp3 Mic 08-09 • Mp3 06-08 • Vespa Gt 60 Eu3 06-07 • Vespa Gts 05-13 • Vespa Gtv 4T Navy Eu3 07 • Vespa Gtv 06-09 • Vespa Gts Abs 05-12 • X Evo 07-13 • X7 Eu3 08 • X8 Eu3 05-08 • X9 Evolution 04-08



10 068 6520 

420: Ape MP



10 068 9410 

500: X9 01-02



10 068 9500 

500: Beverly 02-03





SERIE GUARNIZIONI MOTORE
ENGINE GASKET SETS

SUZUKI

10 068 0830



50: Motore F. Morini



10 068 0060



50: Katana 50 LC • Zillion

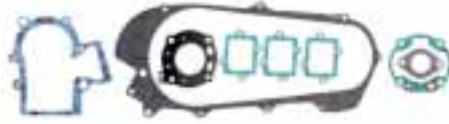

10 068 9510



125: Burgman 02-03



10 068 9120



250: Burgman 98-02



10 068 9440



150: Burgman



10 068 9450



250: Burgman 03-06

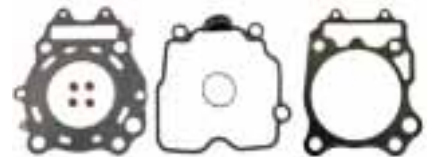

10 068 9130



400: Burgman 99-02



10 068 9460



400: Burgman 03-06



YAMAHA

10 068 0010



50: BW'S 90-93



10 068 3000



50: CT



10 068 2500



50: CY (3YE1) Jog 90-99



10 068 0070



50: Motore Ma-My 50
Raffreddato aria e liquido (Cilindro orizzontale)
Air and liquid cooled (Horizontal cylinder)



10 068 9820



50: Neo'S 4T 08-15



10 068 9470



100: BW'S • Aerox • Neo's • Booster • Nitro • Ovetto

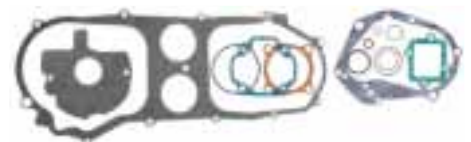



YAMAHA

10 068 9810 

125: X-Max 06-13

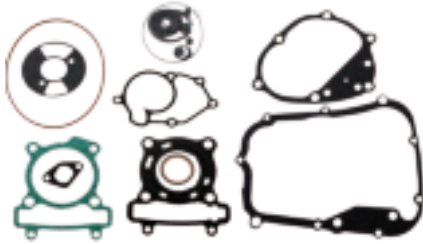

10 068 9140 

125: Teo's • Maxter 01 • Majesty 98-01



10 068 9150 

10 068 9151  

150: Majesty



10 068 9530 

10 068 9531  

180: Majesty 03-05



10 068 9160 

250: Majesty 96-01 • X City 07-08 • X Max 05-09 • Majesty 96-03 • Dx 98-00 • Abs 03



10 068 9540 

250: X City 09>



10 068 9800 

300: Versity 03-06



10 068 9790 

400: Majesty 04-06

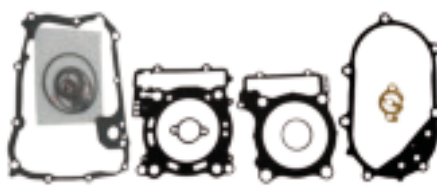

10 068 9520 

500: T-Max 01-11

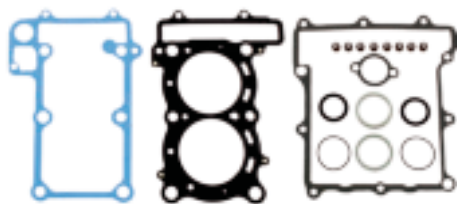

10 068 4300  

530: Xp T-Max Abs 12-15 • Xp T-Max Sp Abs 15 • Xp T-Max Sp 15 • Xp T-Max 12-15
(R.O. 59C114000000)

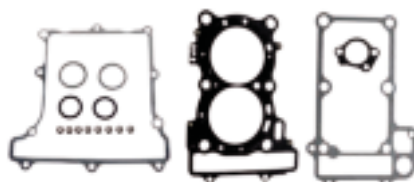



GUARNIZIONI VARIE
VARIOUS GASKETS

KIT GUARNIZIONI CILINDRO - CYLINDER GASKET KIT

10 068 0381



KYMC0 50: 4T
Per cilindro 10 008 0381
For cylinder 10 008 0381



10 068 0391



KYMC0 125: 4T
Raffreddamento aria - *Air cooled*
Per cilindro 10 008 0391
For cylinder 10 008 0391



10 068 0401



KYMC0 150: 4T
Raffreddamento aria - *Air cooled*
Per cilindro 10 008 0401
For cylinder 10 008 0401



10 068 0440



HONDA 150: Sh
Per Cilindro 10 008 0440
For Cylinder 10 008 0440



10 068 0450



HONDA 125: Sh
Per Cilindro 10 008 0450
For Cylinder 10 008 0450



10 068 9000



**APRILIA - MINARELLI - MBK
YAMAHA SCOOTER**
Motori cilindro verticale raffr. aria
Vertical cylinder air cooled
(Conf. 5 pz. - Pack 5 pcs)



10 068 9010



**APRILIA - MINARELLI - MBK
YAMAHA SCOOTER**
Motori cilindro orizzontale raffr. aria
Horizontal cylinder air cooled
(Conf. 5 pz. - Pack 5 pcs)



10 068 9020



APRILIA - MINARELLI - MBK -YAMAHA
Motori raffreddati a liquido
Liquid cooled cylinder
(Conf. 5 pz. - Pack 5 pcs)



10 068 9030



PEUGEOT SCOOTER:
Motori raffr. ad aria - *Air cooled*
(Conf. 5 pz. - Pack 5 pcs)



10 068 9040



PIAGGIO - GILERA SCOOTER
Motori raffr. ad aria - *Air cooled*
(Conf. 5 pz. - Pack 5 pcs)



10 068 9050



GILERA: Runner 97-00
PIAGGIO: Nrg Extreme 99-00
Ntt 95-96 • Nrg 94-96
Nrg Rst Mc2 96-98 • Zip Sp 96-00
Motori raffr. a liquido - *Liquid cooled cylinder*
(Conf. 5 pz. - Pack 5 pcs)

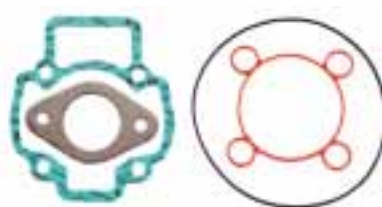

10 068 9060



HONDA SCOOTER
Sh 96> • Sfx • Sky • Balj
Motori raffr. ad aria - *Air cooled*
(Conf. 5 pz. - Pack 5 pcs)





KIT GUARNIZIONI CILINDRO - CYLINDER GASKET KIT

10 068 9070 

GILERA LC: Runner Poggiali • Runner FL 02
PIAGGIO LC: Nrg Mc3 01-02 • Zip Sp 01-02
Motori raffr. a liquido - *Liquid cooled*
(Conf. 5 pz. - *Pack 5 pcs*)

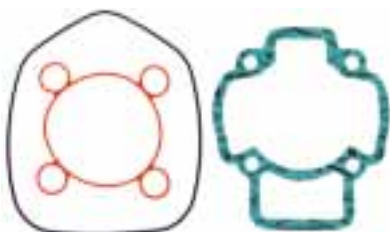

10 068 9170 

APRILIA: Sr Di Tech 00 00-03



10 068 9480 

GILERA : Runner Purejet 02-04
PIAGGIO: Nrg Purejet 02-04



10 068 9630 

MINARELLI: Am6 II Serie - *New Model*



10 068 9670 

MINARELLI: Motore AM6 50 cc.

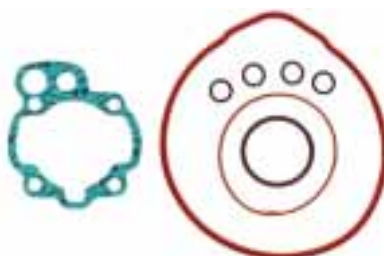

KIT GUARNIZIONI CILINDRO RACING Ø 47 - CYLINDER GASKET KIT RACING Ø 47

10 068 9600 

Serie guarnizioni Piaggio aria Ø 47
Gasket set Ø 47 for Piaggio air cooled
GILERA 50: Easy Moving 95-96 • Stalker 97-04
Storm 94-95 • Typhoon 94-97
PIAGGIO 50: Free 92-94 • Free FL 95-02
Liberty 97-05 • Sfera 91-93 • Sfera Rst 95-97
Zip 92-93 • Zip Fast Raider Rst 96-97
Per cilindro 10 008 0240
For cylinder 10 008 0240



10 068 9610 

Serie guarnizioni Piaggio liquido modelli fino
al 2000 Ø 47 mm
Gasket set Piaggio liquid cooled Ø 47 < 2000
Per cilindro 10 008 0320
For cylinder 10 008 0320



10 068 9620 

Serie guarnizioni Piaggio liquido modelli dal
2001 Ø 47 mm
Gasket set Piaggio liquid cooled Ø 47 > 2000
Per cilindro 10 008 0330
For cylinder 10 008 0330



10 068 9720 

Serie guarnizioni per cilindro Piaggio raffr. aria
Ø 47 mm
Gasket sets for Piaggio air cooled Ø 47 mm
Per cilindro 10 008 0480
For cylinder 10 008 0480



10 068 9730 

Serie guarnizioni Minarelli Oriz. Ø 47 mm
Gasket sets for Minarelli Horizontal Ø 47 mm
Per cilindro 10 008 0490
For cylinder 10 008 0490



10 068 9740 

Serie guarnizioni per cilindro Minarelli Vert. Ø 47 mm
Gasket sets for Minarelli vertical Ø 47 mm
Per cilindro 10 008 0500
For cylinder 10 008 0500





GUARNIZIONI VARIE VARIOUS GASKETS

KIT GUARNIZIONI CILINDRO RACING Ø 47 - CYLINDER GASKET KIT RACING Ø 47

10 068 9750 

Serie guarnizioni per cilindro Minarelli liquido Ø 47 mm
Gasket sets for Minarelli liquid cooled Ø 47 mm
Per cilindro 10 008 0510
For cylinder 10 008 0510



10 068 9760 

Serie guarnizioni Piaggio liquido modelli fino al 2000 Ø 47 mm
Gasket set Piaggio liquid cooled Ø 47 < 2000
Per cilindro 10 008 0560
For cylinder 10 008 0560

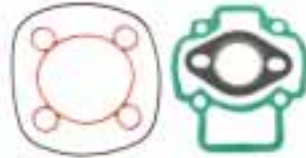

10 068 9770 

Serie guarnizioni Piaggio liquido modelli dal 2001 Ø 47 mm
Gasket set Piaggio liquid cooled Ø 47 > 2000
Per cilindro 10 008 0570
For cylinder 10 008 0570



10 068 9840  

Serie Guarnizioni Cilindro
Cylinder Gasket Set
Per cilindro 10 008 0610
For cylinder 10 008 0610



GUARNIZIONI BASE CILINDRO - BUTTON CYLINDER GASKET

10 070 2010 

APRILIA: 50 Amico
MBK: Booster 90-95
(Conf. 25 pz. - Pack 25 pcs)



10 070 2020 

MOTORI MINARELLI: CY, MY 50
Raffr. aria - Air cooled
APRILIA: Sr • Scarabeo • Rally • Gulliver
MBK: 50 Evolis • (Conf. 25 pz. - Pack 25 pcs)



10 070 2030 

MOTORI MINARELLI: MA 50
Raffr. acqua - Liquid cooled
APRILIA: Sr 50 LC • **MALAGUTI:** Phantom 50 LC
(Conf. 25 pz. - Pack 25 pcs)



10 070 2300 

GILERA: 50 Typhoon • Storm
PIAGGIO: Sfera • Zip • Free 91-96
(Conf. 25 pz. - Pack 25 pcs)



10 070 3030 

PIAGGIO: Vespa 50-90-125 • Primavera ET3
Ape 50 • TM 50 • P 50
(Conf. 25 pz. - Pack 25 pcs)



10 070 3050 

PIAGGIO: Quartz 50 • Nrg 50 95-96
Spessore 0,5 mm - Thickness 0,5 mm
(Conf. 10 pz. - Pack 10 pcs)





GUARNIZIONI BASE CILINDRO - BUTTON CYLINDER GASKET

10 070 4010 

PIAGGIO: Vespa Px 200 • Pxe 200
• Cosa 200 Vsr1t
(R.O. 191695)
(Conf. 25 pz. - Pack 25 pcs)



10 070 3080 

PIAGGIO: Ape MP Car • MPV • TM 602 • 703
(Conf. 50 pz. - Pack 50 pcs)



10 070 3090 

PIAGGIO: Vespa Pk 125 XL Vmx6t
(R.O.826911)
(Conf. 25 pz. - Pack 25 pcs)



10 070 4000 

PIAGGIO: Vespa Px125-150- Vnx-Vlx
Vespa Pxe 125-150- Vnx2-Vlx2
Cosa 125-150 Vlr1T
(Conf. 25 pz. - Pack 25 pcs)



GUARNIZIONE SCARICO - EXHAUST GASKET

10 070 4500 

APRILIA: 50 Amico • SR • Scarabeo • Rally
• Gulliver
MBK: Booster • Evolis 50 90-95
(Conf. 25 pz. - Pack 25 pcs)



10 070 4510 

APRILIA: SR • Scarabeo (a Flangia - Flange).
(Conf. 50 pz. - Pack 50 pcs)



10 070 4520 

APRILIA: SR 50 LC
MOTORI FRANCO M.: AH 50 L
ITALJET: Formula
MALAGUTI: Crosser • Phantom 50 LC Raffr.
Acqua - Liquid cooled
SUZUKI: 50 94-95
(Conf. 50 pz. - Pack 50 pcs)



10 070 5010 

KYMCO: Djy 50
PEUGEOT: Buxy • Speedake • Squab • SV 50
Geo • Zenith
HONDA: 50 • Pk Wallaroo • GP • SP • HSS
• Dio • SK • SA • SJ 50 Bali 94-95
(Conf. 25 pz. - Pack 25 pcs)



10 070 5100 

PIAGGIO: Vespa 50 • PK 50 XL • Rush
Ø 6
(Conf. 50 pz. - Pack 50 pcs)



10 070 5111 

PIAGGIO: Vespa 50-125 • Primavera ET3
PK 50 • Ape 50 • TM • P 50
Ø 8
(Conf. 25 pz. - Pack 25 pcs)





GUARNIZIONI VARIE
VARIOUS GASKETS

GUARNIZIONE SCARICO - EXHAUST GASKET

10 070 5120



PIAGGIO: Vespa Pk 125 XL
(Conf. 25 pz. - Pack 25 pcs)



10 070 5130



PIAGGIO: Sfera • Free • Zip • Fast Rider 91-93
(Conf. 50 pz. - Pack 50 pcs)



10 070 5140



PIAGGIO: Nrg • Ntt • Quartz
GILERA: Typhoon 91-93
(Conf. 50 pz. - Pack 50 pcs)



10 070 5150



PIAGGIO: Zip • Quartz
GILERA: Typhoon • Storm 91-93
(Conf. 25 pz. - Pack 25 pcs)



10 070 5320



PIAGGIO: Ape Car • TM.
(Conf. 25 pz. - Pack 25 pcs)



GUARNIZIONE ASPIRAZIONE - INDUCTION GASKET

10 070 3520



APRILIA: Sr • Scarabeo • Rally • Gulliver • Sr 50 Lc
MALAGUTI: Phantom 50 Lc • F 10
YAMAHA: Cy • My • Ma
MBK: 50 Evolis 93-95
(Conf. 25 pz. - Pack 25 pcs)



10 070 3930



PIAGGIO: Ape 50 • Tm 50 P 50
(Conf. 25 pz. - Pack 25 pcs)



10 070 3950



PIAGGIO: Vespa 50-90-125
(R.O. 078543)
(Conf. 25 pz. - Pack 25 pcs)



10 070 3960



PIAGGIO: Vespa Pk 50
(R.O. 196431)
(Conf. 25 pz. - Pack 25 pcs)





GUARNIZIONI VARIE - VARIOUS GASKET

10 070 1010 

GUARNIZIONE TESTA MOTORE
CYLINDER HEAD GASKET
APRILIA: Amico - **MBK:** Booster
YAMAHA: Ct • Cr 50 Z 90-95
(Conf. 25 pz. - Pack 25 pcs)



10 070 1020 

GUARNIZIONE TESTA MOTORE
CYLINDER HEAD GASKET
MOTORI MINARELLI: Cy • My 50 93-95
Raffr. aria • *Air cooled*
APRILIA: SR • Scarabeo • Rally • Gulliver
YAMAHA: CY • MY 50 • CH 50 Beluga
MBK: 50 Evolis -
(Conf. 10 pz. - Pack 10 pcs)



10 070 3970 

GUARNIZIONE FILTRO
GASKET FILTER
PIAGGIO: Vespa 50-90
V5A1-V5B1-V5B2-V5SA1-V9A1
(R.O. 79900)
(Conf. 25 pz. - Pack 25 pcs)



10 070 3980 

GUARNIZIONE PRESELETTORE CAMBIO
GASKET GEAR SELECTOR
PIAGGIO: Vespa Px 125-150-200 • Pxe 125-150-
200 T5 150 GL • Sprint • Super • Rally
VNX - VLX - VBX - VNX5T - VNX2 - VLX2 - VSX1 -
VLA - VLB - VBC
(Conf. 25 pz. - Pack 25 pcs)
(R.O. 47162)



10 070 5160 

GUARNIZIONE SILENZIATORE
SILENCER GASKET
PIAGGIO: Motori 4T - *Four Stroke Engine*
125-180-200-250-300
(R.O. 8263885)



10 070 5610 

GUARNIZIONE COPERCHIO CARTER FRIZIONE
CLUTCH COVER GASKET
APRILIA: SR • Scarabeo • Rally • Gulliver • Sr 50 Lc
MALAGUTI: F 12 • Phantom Lc Raffr. acqua
Motori Minarelli: My 50 Raffr. aria
• Ma Raffr. Acqua 93-95
(Conf. 10 pz. - Pack 10 pcs)



10 070 6200 

GUARNIZIONE COPERCHIO CARTER FRIZIONE
CLUTCH COVER GASKET
PIAGGIO: Vespa 50-90-125 • Primavera Et3 Pk
50 • 125 • Ape 50 • Tm 50 • P 50
(Conf. 50 pz. - Pack 50 pcs)



10 070 6500 

GUARNIZIONE COPERCHIO CARTER
TRASMISSIONE
TRANSMISSION COVER
APRILIA: Amico • Sr • Scarabeo • Rally
Gulliver • SR 50 Lc
MALAGUTI: F 10 • F 12 • Phantom Raffr. aria e
acqua - *Air and water cooled*
MBK: Booster • M. minarelli, Ma
YAMAHA: CY 50 • MY 50 90-95
(Conf. 10 pz. - Pack 10 pcs)



10 070 7120 

GUARNIZIONE COPERCHIO CARTER
TRASMISSIONE
TRANSMISSION COVER
PIAGGIO: Vespa 50-90-125
• Primavera Et3 Pk 50-125
Flangia portaganasce posteriori
Rear brake shoes flange
(Conf. 25 pz. - Pack 25 pcs)





GUARNIZIONI VARIE
VARIOUS GASKETS

GUARNIZIONI VARIE - VARIOUS GASKET

10 070 8000



GUARNIZIONE RONDELLE FIBRA
WASHER FIBRE

Rondella Ø 8 x 12 x 1 - Washer Ø 8 x 12 x 1
(Conf. 50 pz. - Pack 50 pcs)



10 070 9040



GUARNIZIONE BASE CARBURATORE
GASKET CARBURETOR

(Conf. 25 pz. - Pack 25 pcs)
(R.O.131079)



10 070 9050



GUARNIZIONE BASE CARBURATORE
GASKET CARBURETOR

(Conf. 25 pz. - Pack 25 pcs)
(R.O. 131115)



12 183 0650



GUARNIZIONE SERBATOIO GOMMA
RUBBER TANK GASKET

PIAGGIO 125-150-200: Vespa Px
VNX-VLX-VSX
(R.O. 159804)



12 183 0660



GUARNIZIONE SERBATOIO SUGHERO
CORK TANK GASKET

PIAGGIO 125: Vespa 125 anni 48-52
(R.O. 003979)



12 183 0670



GUARNIZIONE SERBATOIO SUGHERO
CORK TANK GASKET

PIAGGIO 125: Vespa 125 anni 53-54
(R.O. 016704)



12 183 0680



GUARNIZIONE SERBATOIO SUGHERO
CORK TANK GASKET

PIAGGIO 125-150: Vespa anni 55-57
(R.O. 028231)



12 183 0690



GUARNIZIONE TAPPO BENZINA SUGHERO
CORK GASKET FUEL CAP

PIAGGIO 50-90-125: Vespa Primavera -Et3
V5A1-V5B1-V5B2-V5SA1-V9A1-VMA2-VMB1-
VNA-VNB
(Conf. 5 pz. - Pack 5 pcs)



12 183 0700



GUARNIZIONE TAPPO BENZINA SUGHERO
CORK GASKET FUEL CAP

PIAGGIO 125-150-200: Vespa Px V5A1-V5B1-
V5B2-V5SA1-V9A1-VMA2-VMB1-VNA-VNB
(Conf. 5 pz. - Pack 5 pcs)



12 183 0710



GUARNIZIONE RUBINETTO BENZINA
SUGHERO

CORK (PACK 5 PCS) GASKET FUEL COCK
PIAGGIO 50-90-125: Vespa Primavera -Et3
V5A1-V5B1-V5B2-V5SA1-V9A1-VMA2-VMB1-
VNA-VNB
(Conf. 5 pz. - Pack 5 pcs)



12 183 0720



GUARNIZIONE RUBINETTO BENZINA
SUGHERO

CORK (PACK 5 PCS) GASKET FUEL COCK
PIAGGIO 125-150-200: Vespa Px VNX-VLX-VSX
(Conf. 5 pz. - Pack 5 pcs)





O-RING

10 070 6210 

GUARNIZIONE COPERCHIO FRIZIONE
CLUTCH COVER GASKET

Vespa 150 GL • Sprint • Vespa Px 125-150
(Conf. 5 pz. - Pack 5 pcs)
(R.O. 017881)



10 070 6220 

O RING LEVETTA CAMBIO 6,75X2
O RING LEVER CHANGE

PIAGGIO 50-90-125: Vespa primavera - Et3
V5A1-V5B1-V5B2-V9A1-VMA2-VMB1
(Conf. 50 pz. - Pack 50 pcs)
(R.O. 006706)



10 070 6230 

O RING LEVETTA CAMBIO 8,73X1,78
O RING LEVER CHANGE

PIAGGIO: Vespa Pk-Px
V5X1T-V5X2T-V5X3T-VN1XT-VLX1T
(Conf. 50 pz. - Pack 50 pcs)
(R.O. 006708)



10 070 6240 

O RING PER CAMMA FRENO 11,11X1,78
O RING REAR CAM

PIAGGIO 125-150-200: Vespa Px
VN1XT-VLX1T-VSX1T
(Conf. 50 pz. - Pack 50 pcs)
(R.O. 006714)



10 070 6250 

O RING PER SETTORE M. MOTO 15,88X2,62
O RING KICK STARTER SECTOR

PIAGGIO 125-150-200: Vespa Px
VN1XT-VLX1T-VSX1T
(Conf. 50 pz. - Pack 50 pcs)
(R.O. 006721)



10 070 6260 

O RING PER PERNO RUOTA 23,4X3,53
O RING HUB

PIAGGIO 125-150-200: Vespa Px
VN1XT-VLX1T-VSX1T
(Conf. 50 pz. - Pack 50 pcs)
(R.O. 006731)



10 070 6270 

O RING KARTER
O RING CRANKCASE

PIAGGIO 50-90-125: Vespa Primavera -Et3
V5A1-V5B1-V5B2-V9A1-VMA2-VMB1
(Conf. 50 pz. - Pack 50 pcs)
(R.O. 006716)



10 070 6280 

O RING PERNO SOSPENSIONE
O RING FRONT WHEEL PIN

PIAGGIO 125-150-200: Vespa Px
VN1XT-VLX1T-VSX1T
(Conf. 50 pz. - Pack 50 pcs)
(R.O. 177408)



10 070 6290 

O RING MOZZO POSTERIORE
O RING REAR HUB

PIAGGIO 125-150-200: Vespa Px
VN1XT-VLX1T-VSX1T
(Conf. 50 pz. - Pack 50 pcs)
(R.O. 78163)



10 070 6300 

O RING MOZZO POSTERIORE
O RING REAR HUB

Vespa old models
(Conf. 50 pz. - Pack 50 pcs)
(R.O. 79164)



10 070 6310 

O RING TAMBURO POSTERIORE
REAR DRUM O RING KIT

PIAGGIO 125-150-200: Vespa Px-Pxe Arcobaleno-VNX-VLX-VSX-VNX2-VLX2-VSX2
(R.O. 139433)



10 070 9030 

KIT O RING (Pack 7 Pcs)
PIAGGIO: Vespa Px -Sprint

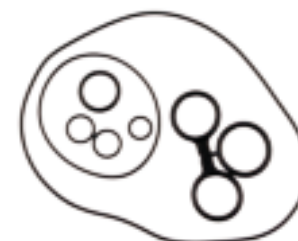

10 070 9000 

KIT O RING 382 PZ. 32 MISURE NBR
KIT O RING 382 PCS. 32 SIZES NBR



10 070 9010 

GUARNIZIONE O-RING COPERCHIO VALVOLE
VALVE COVER O-RING

KYMCO 50: Agility 4T • Dink 4T • Filly Lx • Like 4T • People S 4T • Super 8 4T • Vitality 4T
(R.O. 00102064)
(Conf. 10 pz. - Pack 10 pcs)



10 070 9020 

GUARNIZIONE O-RING COPERCHIO VALVOLE
VALVE COVER O-RING

KYMCO 125-150-200: Agility R16 4T
(R.O. 00122754)
(Conf. 5 pz. - Pack 5 pcs)





KIT REVISIONE POMPA ACQUA
WATER PUMP REPAIR KITS

APRILIA

10 011 0010

Motori Minarelli 50 cc
Con paraolio doppia tenuta
With special watertight seal



10 011 0200

Motori Minarelli 50 cc
Con paraolio doppia tenuta
e completo di disco traino
With special watertight seal including water pump plate



10 011 0080

Motori Minarelli 50 cc Am6 • Am345



10 011 0160

50: Sr Ditech Eu2 02-03 • Sr H2O Ditech e
Carburatore 00-03 • Sr R Factory Motore Aprilia 05



10 011 0230

125: Atlantic Eu3 06-08 • Scarabeo Eu3 06-07 •
Sport City Eu3 06-08
200: Scarabeo Eu3 06-07 • Sport City Eu3 06-08



10 011 0170

125: Leonardo 96-01 • Scarabeo Motore Rotax 99-03
150: Leonardo 96-01 • Scarabeo Motore Rotax 99-03
200: Scarabeo Motore Rotax 99-03



10 011 0300

250: Leonardo 99-01 • Leonardo St 01





BETA

10 011 0080

Motori Minarelli 50 cc Am6 • Am345



DERBI

10 011 0320

50: Senda R Drd Pro Eu2 05-09 • Senda R Drd Racing Eu2 05-08 • Senda Rx-Race Eu2 07-09 • Senda Rx-Trem Eu2 08 • Senda Sm Drd Pro Eu2 05-08 • Senda Sm X Trem Eu2 08 • Senda Sm X-Race Eu2 07-09



10 011 0240

50: Atlantis Lc 99-01 • Predator Lc 98-01



10 011 0250

50: Gpr Nude 04-05 • Gpr Racing 04-05 • Senda R 99-01 • Senda R Drd Racing 04-05 • Senda R Racer 03 • Senda Sm 00-01 • Senda Sm X-Race 04-05



GILERA

10 011 0230

125: Nexus Eu3 07-08 • Runner Vx 4T Eu3 07



10 011 0070

125: Dna 01 • Runner Vx Vxr 00-01
180: Dna 01-Runner Vx • Vxr 00-04





KIT REVISIONE POMPA ACQUA
WATER PUMP REPAIR KITS

GILERA

10 011 0020 

50: Dna 00-02 • Runner 97-00 • Runner Purejet 02-07 • Runner Sp 02-07

10 011 0030 

125-180: Runner Fx-Fxr 97-02



10 011 0210 

250: Nexus Eu3 06-07 • Oregon 06-08
300: Nexus Eu3 08-09



HONDA

10 011 0180 

125-150: Pantheon 2T 98-02



10 011 0190 

125-150: Chiocciola 00-06 • Sh 125 01-08



10 011 0510 

125-150: Pcx



10 011 0310 

250: Foresight 98





HONDA

10 011 0520 

300: Sh 07-14



KYMCO

10 011 0480 

50: B&W Eu2 03 • B&W 02 • Dink Lc 98-02 •
Super 9 00-04



10 011 0470 

125-150: B&W Eu2 03-04 • B&W 00 • Dink 97-
98 • Dink Classic 02-03 • Dink Lx 98-00 • Gran
Dink 01-02
200: Dink Classic 04



10 011 0490 

200: Dntown i 10 • People Gti 10
300: Dntown Abs 10-11 9 Dntown i 11 •
K-Xct i 12-14 • People Gti 10-12



10 011 0460 

250: B&W 00 • B&W Eu2 03 • Gran
Dink 01-02 • Gran Dink Eu2 03-04
• People Lc 03-04 • People S 06 •
People S i 07 • X-Citing 05 9 X-Citing
06-07 • Yup 03
300: People S i 08 • X-Citing i 08 •
X-Citing i R 08-09



10 011 0550 

400: X Citing i 13 • X Citing i Abs 14



10 011 0500 

700: Myroad i 11





KIT REVISIONE POMPA ACQUA
WATER PUMP REPAIR KITS

MBK

10 011 0430 

50: Nitro 97-02 • Nitro Eu2 03



10 011 0010 

Motori Minarelli 50 cc
 Con paraolio doppia tenuta
 With special watertight seal



10 011 0200 

Motori Minarelli 50 cc
 Con paraolio doppia tenuta
 e completo di disco traino
 With special watertight seal including water
 pump plate



10 011 0090 

125: Skyliner 98-03
 150: Skyliner 00-02
 180: Skyliner 03



PEUGEOT

10 011 0080 

Motori Minarelli 50 cc Am6 • Am345



10 011 0530 

50: Speedfight • X Fight • X Race • XTeam 2
 (R.O. 734428-743278)



10 011 0560 

50: Neo's 4T





PIAGGIO

10 011 0020 

PIAGGIO 50: Nrg 94-96 • Nrg Purejet 02-04
 • Quartz 92-96 • Zip Sp 96-00



10 011 0230 

125: Beverly Rst 06-07 • Vespa Granturismo
 06-07 • X8 05-06 • X9 Evolution 05-06
200: Vespa GT 06-07 • X8 05-07

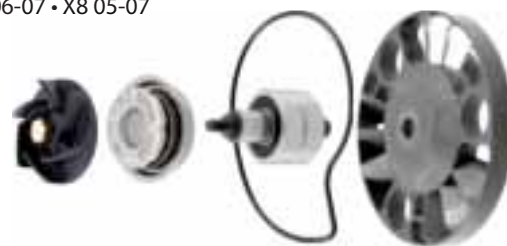

10 011 0070 

125: Beverly 01-03 • Beverly Rst 04-05
 • Hexagon Gtx 00 • Vespa Gt 03-05 • X9
 01-02 • X9 Evolution 03
180: Hexagon Gtx 00
200: Beverly 01-03
 • Vespa Granturismo
 03-05



10 011 0030 

125: Hexagon 94-97 • Hexagon Lx-Lxt 98-99
150: Hexagon 94-97
180: Hexagon Lx-Lxt 98-99



10 011 0220 

250: Beverly Rst 04-05



10 011 0210 

250: Beverly 06-07 • Beverly Tourer Eu3 08-09 • Carna-
 by 08 • Mp3 06-08 • Vespa Gtv 4T Eu3 08 • X7 Eu3 08 •
 X8 Eu3 05-08 • X9 Evolution 04
300: Beverly ie Tourer 09 • Carnaby Cruiser 09 • Mp3 ie
 Mic 10 • Vespa Gts Super 08 • X7 Evo ie Eu3 09



10 011 0440 

250: Carnaby 08 • Mp3 06-09 • Vespa Gt 60 06-
 07 • Vespa Gts 05-13 • Vespa Gtv 06-09 • X7 Eu3
300: Beverly Rst 4T 4V ie 10-14 • Beverly Tourer
 Eu3 09-10 • Carnaby Cruiser 09-12 • Mp3 10-13
 • Mp3 Yourban 11-12 • Vespa Gts 08-13 • Vespa
 Gtv 10-13 • X7 Evo ie Eu3 09-10



10 011 0450 

400: Beverly 06-10 • Mp3 07-11 • X Evo 07-11 •
 X8 Eu3 06-08
500: Beverly 07-12 • Mp3 11-14 • X10 4T 4V ie
 12-14 • X9 01-02 • X9 Evolution 03-07





KIT REVISIONE POMPA ACQUA
WATER PUMP REPAIR KITS

SUZUKI

10 011 0150

50: Katana I Serie 97-00

10 011 0260

125: Epicuro 99-01
 150: Burgman 02-06 • Epicuro 99-01
 250: Burgman 98-02 • Burgman 03-06
 400: Burgman 03-06 • Burgman 99-02



10 011 0410

SUZUKI 400: Burgman 07-08



YAMAHA

10 011 0010

Motori Minarelli 50 cc
 Con paraolio doppia tenuta
With special watertight seal

10 011 0200

Motori Minarelli 50 cc
 Con paraolio doppia tenuta
 e completo di disco traino
With special watertight seal including water pump plate



10 011 0430

50: Aerox 97-10 • Aerox Eu2 03

10 011 0080

Motori Minarelli 50 cc Am6 • Am345





YAMAHA

10 011 0090 

125: Majesty 98-09
150: Majesty 00-02
180: Majesty 03-06



10 011 0350 

125: X City • X Max



10 011 0540 

125: Xenter 12-14 • Xcr 12 Majesty S
150: Xenter 12-14



10 011 0270 

250: Majesty 00-03



10 011 0280 

400: Majesty 04-08 • Majesty Abs 07-08



10 011 0290 

500: T-Max 04-11

10 011 0420 

530: T-Max 12-13





VARI
VARIOUS

10 012 0010 

TERMOSTATO - THERMOSTAT

KYMCO 50: B&W/Eu2 02-03 • Dink Lc 98-02 • Super 9/Sport Eu2 00-04

125: Dink Eu3 06-07 • Downtawn/i 09 • People Gti 10

125-150: B&W/Eu2 00-04 • Dink 07-98 • Dink Classic Eu2 02-03 • Dink Lx 98-00 • Grand Dink Eu2 01-04

200: Dink classic Eu3 i 04-07 • Downtown 10 • People Gti 10

250: B&W Eu2 00-03 • Grand Dink Eu2 01-04 • Kxr 03-04 • Mxu 05 • X Citing 05 • Yup 03

300: Downtown/i Abs 09-10 • Maxxer 05-06 • Mxu 05-06 • Mxur 10 • People S i 08 • Gti 10 • X Citing i/i R 08-09

Di primo equipaggiamento - *OEM Quality*
(R.O. 00129962)



10 012 0040 

TERMOSTATO - THERMOSTAT

KYMCO 300: Downtown Abs i 11

• Downtown i 11 • People Gti 11
(R.O. 00119113-19300-LFA7-E00)



24 640 0032 

RELÈ VENTOLA - COOLING FAN RELAY

KYMCO 125: Downtown i 09 • K-Xct i 12

200: Downtown i 10

300: Downtown i 09 • Downtown Abs i 11 •

Downtown Abs 10 • Downtown i 11 • K-Xct i 12

(R.O. 0139005-39100-LEA7-E00)



24 640 0042 

RELÈ VENTOLA - COOLING FAN RELAY

KYMCO 125: G-Dink 12 • People Gti 10

200: People Gti 10

300: G-Dink 12 • People Gti 10-11 • People Abs 12

700: Myroad i 11

(R.O. 0139021-39100-KKE5-E01)



10 011 0050 

POMPA OLIO-OIL PUMP

MISCELATORE SCOOTER

MINARELLI • MBK • YAMAHA 50cc



14 274 0080 

VENTOLA VOLANO MODIFICATA

MODIFIED FLYWHEEL FAN

Migliora il raffreddamento

Improve engine cooling

MINARELLI • YAMAHA • MBK 50cc

Cilindro verticale - *Vertical cylinder*



10 011 0040 

KIT DISCO TRAINO GIRANTE POMPA

WATER PUMP PLATE

MOTORI MINARELLI: YAMAHA • APRILIA

• **MALAGUTI • MBK 50cc**



▶ CUSCINETTI
BEARINGS

▶ KIT REVISIONE
ALBERI MOTORE
CRANKSHAFT SERVICING KIT

▶ SERIE PARAOLIO
MOTORE
OIL SEAL KIT



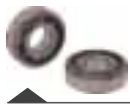

CUSCINETTI RADIALI A SFERE

BALL BEARINGS

DATI TECNICI SUI CUSCINETTI - BALL BEARINGS SPECIFICATIONS

BB1 =Cuscinetti a sfere esecuzione speciale - *Deepgroove ball bearings with special execution*
 TN9 =Gabbia stampata di Poliammide 6,6 rinforzata con fibre di vetro - *Nylon cage reinforced with fiberglass*
 TOLLERANZA INTERNA =C1: Tolleranza inferiore a C2 - *Clearance inferior than C2*
 CLEARANCE = C2: Tolleranza inferiore al normale - *Clearance inferior than standard*-C3: Tolleranza maggiore del normale - *Clearance superior than standard*
 C4: Tolleranza maggiore di C3 - *Clearance superior than C3* - C5: Tolleranza maggiore di C4 - *Clearance superior than C4*



MARCA TRADE	MISURE SIZE	CODICE RMS RMS CODE	APPLICAZIONE APPLICATION	MODELLO - TRADE MARK	CODICE ORIGINALE ORIGINAL CODE
	● 10 - 30 - 9 (6200 C3)	10 020 0200	Albero primario <i>Driven pulley shaft</i>	MOTORI MINARELLI - MBK - YAMAHA: Scooter 50 PIAGGIO: Vespa 50-125 - PK XL - Rush - N - FL - FL2 HP - PK 50-125 - APE 50P - FL-FL2-FL3-Rst mix	007035
	● 12 - 32 - 10 (6201 C3)	10 020 0020	Albero primario <i>Driven pulley shaft</i>	HONDA: Sh 50 - 100 90> NH-Sfx-Sky-X8R - Vision-Shadow - Balj 50/100	96100-62013-00
	● 12 - 37 - 12 (6301)	10 020 0230	Albero primario <i>Driven pulley shaft</i>	PIAGGIO: Vespa 50-125 - Pk 50-125 - Pk XL-Ape 50P - FL - FL2 - FL3 Europa-Rst mix	002800
	● 12 - 40 - 12	10 020 0500	Ingranaggio multiplo <i>Gearbox bearing</i>	HONDA: Sky - Balj 100 - CH 125 Spacy - Cn 250	91003-K54-003 (R.O. 090024)
	● 15 - 35 - 11 (6202 C3)	10 020 0240	Asse ruota post. <i>Rear wheel axle</i>	PIAGGIO 125: Vespa Gts - Ts - 150: Vespa Sprint - Veloce - Super - Px VNL2T-VLN3-VLB-VLB1T-VBC1T-VNX1T-VLX1T	097718
	● 15 - 42 - 13	10 020 0640	Asse ruota post. <i>Rear wheel axle</i>	HONDA: Sfx - Sky - Vision 50 - Phanteon 125/150	96100-62023-00
	■ 17 - 40 - 12 (6203 TN9-C5H)	10 020 0080	Albero motore <i>Crankshaft</i>	PIAGGIO 50: Ciao - Bravo - Boxer - Si	102258
	● 17 - 40 - 12 (6203)	10 020 0250	Asse ruota post. <i>Rear wheel axle</i>	PIAGGIO 50-125: <i>Old Model</i>	030209
	● 17 - 40 - 12 (6203 C3)	10 020 0450	Albero primario <i>Driven pulley shaft</i>	PIAGGIO - GILERA: Runner - Stalker 50 - Liberty 50 - Nrg Extreme - Et2 - Et2 liniezione - Velofax	002802
	● 17 - 47 - 14 (6303)	10 020 0090	Ruota anteriore <i>Front Wheel</i>	PIAGGIO: Vespa 50-90-125 Primavera	002802
	● 17 - 47 - 14 (6303 C3)	10 020 0430	Albero primario <i>Driven pulley shaft</i>	Motori Scooter 50: MINARELLI - MBK - YAMAHA - HONDA: Sh 100 99/00	002802
	● 20 - 42 - 9 (BB1-3573)	10 020 0650	Ruota anteriore <i>Front Wheel</i>	PIAGGIO: Vespa 50-90-125 Primavera	008019
	● 20 - 42 - 12 (6004)	10 020 0270	Carter <i>Crank-case</i>	KYMCO: 50 2T	008019
	● 20 - 47 - 14 (6204 C5)	10 020 0110	Albero motore <i>Crankshaft</i>	PIAGGIO: Vespa 50-125 - Pk 50 XL - Rush - N - FL 50-125 - FL2 HP50 PK 50-125 - PK Automatica - Ape P50 - FL - FL2 - FL3 - Rst mix	227687
	● 20 - 47 - 14 (6204 C3)	10 020 0390	Tamburo freno ant. <i>Front brake drum</i>	PIAGGIO: Ape TM P703-P703 V Diesel/miscela-Car-Max Diesel-TM P602	227687
	● 20 - 47 - 14 (6204 C3)	10 020 0390	Albero motore <i>Crankshaft</i>	PIAGGIO: 50-90-125 Primavera	227687
	■ 17 - 47 - 14 (6303TN9C3)	10 020 0550	Albero motore <i>Crankshaft</i>	MINARELLI 50: AM345-AM6	-
	● 20 - 42 - 9 (BB1-3573)	10 020 0650	Albero motore lato volano <i>Crankshaft flywheel side</i>	PIAGGIO 50-125: <i>Old Model</i>	012501
	● 20 - 42 - 12 (6004)	10 020 0270	Albero motore lato volano <i>Crankshaft flywheel side</i>	HONDA: Sfx - Balj 50/100 - Shadow 50/90 - CH 125 Spacy	9009-GEO-003
	● 20 - 47 - 14 (6204 C5)	10 020 0110	Albero motore lato volano <i>Crankshaft flywheel side</i>	PIAGGIO: Vespa 50-125 - Pk 50-125 - PK XL - Rush - N - FL - FL2 50 Ape P50 - FL - FL2 - FL3 Europa - Rst mix 50	090131
	● 20 - 47 - 14 (6204 C3)	10 020 0390	Albero motore lato volano <i>Crankshaft flywheel side</i>	PIAGGIO: 50-90-125 Primavera	090131

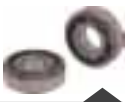

DATI TECNICI SUI CUSCINETTI - BALL BEARINGS SPECIFICATIONS

BB1 =Cuscinetti a sfere esecuzione speciale - *Deepgroove ball bearings with special execution*
 TN9 =Gabbia stampata di Poliammide 6,6 rinforzata con fibre di vetro - *Nylon cage reinforced with fiberglass*
 TOLLERANZA INTERNA =C1: Tolleranza inferiore a C2 - *Clearance inferior than C2*
 CLEARANCE = C2: Tolleranza inferiore al normale - *Clearance inferior than standard-C3: Tolleranza maggiore del normale - Clearance superior than standard*
 C4: Tolleranza maggiore di C3 - *Clearance superior than C3 - C5: Tolleranza maggiore di C4 - Clearance superior than C4*



MARCA TRADE	MISURE SIZE	CODICE RMS RMS CODE	APPLICAZIONE APPLICATION	MODELLO - TRADE MARK	CODICE ORIGINALE ORIGINAL CODE
	● 20 - 47 - 14 (6204)	10 020 0590	Campana frizione <i>Clutch bell</i>	PIAGGIO: Vespa 50-125 - Pk 50-125 - PK XL - Rush - N - FL - FL2 50 Ape P50 - FL - FL2 - FL3 Europa - Rst mix 50	090131
	● 20 - 47 - 14 83299-9RTCS31	10 020 0330	Albero motore <i>Crankshaft</i>	Motori Scooter 50: MINARELLI - MBK - YAMAHA	-
	■ 20 - 47 - 14 (6204TN9- C4HLHT23)	10 020 0120	Albero motore <i>Crankshaft</i>	Motori Scooter 50: MINARELLI - MBK - YAMAHA FRANCO MORINI: LATO VOLANO Scooter 50-100-AH Aria-AH L Aria/ Acqua	-
	● 20 - 47 - 14 6204 C4	10 020 0482	Alb. Mot. Lato volano <i>For Crankshaft flywh. Magn.</i>	MOTORI MINARELLI - YAMAHA: Scooter 50	-
	● 20 - 47 - 14 6204 C4	10 020 0630	Albero motore-Crankshaft	PEUGEOT 50: Speed Fight 2 aria-Lc 307 Wrc Silver 05/06-Trk 2 Wrc 04/06 CPI-GENERIC	-
	● 20 - 52 - 12 (BB1-3055B)	10 020 0140	Albero motore <i>Crankshaft</i>	PIAGGIO / GILERA: Scooter 50 PEUGEOT (Scooter 50): Buxy - Zenith - Speedake - SV Geo - Squab- Eliseo-SpeedFight-Trekker-Vivacity PIAGGIO: Vespa 125	(R.O. 431125) (R.O. 722483)
		10 020 0142			(R.O. 610198M)
	■ 20 - 52 - 12 (BB1B-447205A)	10 020 0290	Alb. Mot. Lato volano <i>For Crankshaft flywh. magn.</i>	KYMC0 (Scooter 50): Heroism - Sniper - Sniper DD - People - Top boy	-
	● 22 - 50 - 14 (62/22)	10 020 0420	Mozzo ruota posteriore <i>Rear wheel hub</i>	PIAGGIO: Ape TM P703V-FL2 - TM P703/P703V Diesel - TMP 602-MP P501/P601-Car P2/P3 - Car Max Diesel-Poker Benzina Diesel	(R.O.243303)
	● 25 - 47 - 8 (16005)	10 020 0520	Ingranaggio Frizione <i>Clutch gear</i>	PIAGGIO: Ape 50 - Vespa 50-125-Pic 50-125-Pk XL 50-125	(R.O.007130)
	■ 25 - 52 - 13 (BB1-3056 C)	10 020 0280	Albero motore <i>Crankshaft</i>	FRANCO MORINI: LATO FRIZIONE Scooter 50-100 - AH Aria - AH L aria - Acqua	-
	■ 25 - 52 - 13 (BB1-3056 C)	10 020 0282	Albero motore <i>Crankshaft</i>	FRANCO MORINI: LATO FRIZIONE Scooter 50-100 - AH Aria - AH L aria - Acqua	-
	■ 25 - 52 - 15 (6205-ETN9/C4)	10 020 0540	Albero motore <i>Crankshaft</i>	APPLICAZIONI VARIE - VARIOUS APPLICATIONS	-
	● 25 - 56 - 12 (BB1-3096)	10 020 0150	Albero motore <i>Crankshaft</i>	HONDA: Sh 50-100 (96<) - Sky 50 97< - Balj 100 96 - X8R PEUGEOT: Speedfight 97-98-Trekker 98-SVL 98-Vivacity 99-Eliseo 99-100 cc PIAGGIO: Liberty-Vespa 50 4T 00-02-Zip 00-04	(R.O.91005-KEE-730) (R.O.736052)
			Albero mot. lato pul. motrice <i>For Crankshaft driving pulley side</i>	KYMC0: Sniper 93-96-Heroism 95-97-Top Boy 97-98-People 99-50 cc	(R.O.00109229)
	● 25 - 62 - 12 (BB1-0855)	10 020 0160	Alb. Mot. lato frizione <i>For Crankshaft clutch side</i>	PIAGGIO: Cosa 1/2-Vespa PX-PXE Arcobaleno 125-150/200-PX T5 125	(R.O. 097804)
	25 - 62 - 12	10 020 0163	Alb. Mot. lato frizione <i>For Crankshaft clutch side</i>	PIAGGIO: Cosa 1/2 - Vespa PX - PXE Arcobaleno 125-150-200 - PX T5 125 - Vespa GL-Sprint-Super-Gtr 150	(R.O. 097804)
	● 25 - 62 - 17 (6305-C5)	10 020 0170	Alb. Mot. lato frizione <i>For Crankshaft clutch side</i>	PIAGGIO: Ape Car P2/P3 - MP P501/P601 2ª Serie - TM P602 - P703-P703 V	(R.O. 169809)
	● 25 - 68 - 12 CX (SCO5B31CS37)	10 020 0182	Albero motore <i>Crankshaft</i>	PIAGGIO-GILERA: Typhoon 125-Runner FX/FXR 125/180-Liberty 125 - Sfera 125-Vespa ET4 125-Hexagon LX4 125-150-LX/LXT 125/180-Skipper 125-150-LX 125/150	(R.O.483970)
	● 35 - 72 - 17 (6207C3)	10 020 0662	Albero motore <i>Crankshaft</i>	HONDA: Sh 125/150 SUZUKI 125-150: Epicuro 99-01-Burgman 02-08-Sixteen 08 200: Burgman 07-08 - 250: Burgman 98-06 - 400: Burgman N 99-08	-
	● 35 - 72 - 15	10 020 0672	Albero motore <i>Crankshaft</i>	HONDA: Sh 125-150	-

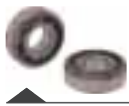

CUSCINETTI RADIALI A SFERE COPERTI DA DUE LATI 2RS1

DOUBLE RUBBER SEALS BALL BEARINGS 2RS1

CUSCINETTI RADIALI A SFERE COPERTI DA DUE LATI 2Z - DOUBLE SHIELD SEALS BALL BEARINGS 2Z

DATI TECNICI SUI CUSCINETTI - BALL BEARINGS SPECIFICATIONS

2Z = Schermo in lamiera non strisciante ad entrambi i lati del cuscinetto - *Not creeping plated shield on both the sides of the bearing*
 C1: Tolleranza inferiore a C2 - *Clearance inferior than C2* - C2: Tolleranza inferiore al normale - *Clearance inferior than standard*
 C3: Tolleranza maggiore del normale - *Clearance superior than standard* - C4: Tolleranza maggiore di C3 - *Clearance superior than C3*
 C5: Tolleranza maggiore di C4 - *Clearance superior than C4*



	12 - 32 - 10 (6201-2Z)	10 020 0350	Varie <i>Various</i>	-	-
	28 - 8 - 9 (638 ZZ ISB)	10 020 0803	Carter Motore <i>Crankcase</i>	Piaggio 50-100: Fly • Liberty • Nrg • Vespa Lx • Vespa S • Zip 2T/4T	82521R

DATI TECNICI SUI CUSCINETTI - BALL BEARINGS SPECIFICATIONS

2RS1 = Guarnizione strisciante di gomma sintetica, rinforzata da una rosetta di lamiera sui due lati del cuscinetto - *Double rubber seals ball bearings*
 TOLLERANZA INTERNA - *CLEARANCE*
 C1: Tolleranza inferiore a C2 - *Clearance inferior than C2* - C2: Tolleranza inferiore al normale - *Clearance inferior than standard*
 C3: Tolleranza maggiore del normale - *Clearance superior than standard* - C4: Tolleranza maggiore di C3 - *Clearance superior than C3*
 C5: Tolleranza maggiore di C4 - *Clearance superior than C4*



MARCA TRADE	MISURE SIZE	CODICE RMS RMS CODE	APPLICAZIONE APPLICATION	MODELLO - TRADE MARK	CODICE ORIGINALE ORIGINAL CODE
	● 8 - 22 - 7 (608-2RSH C3LNT23)	10 020 0190	Pompa acqua <i>Water pump</i>	Motori Scooter 50: MINARELLI - MBK - YAMAHA-PIAGGIO : Scooters 50-125-150-180	(R.O.842797)
	● 10 - 35 - 11 (6300-2RS1)	10 020 0220	Asse ruota anteriore <i>Front wheel axle</i>	MBK : Booster 50 (90-94) - Road - Ng (95-99) - Spirit 50 (96-99) - Track - Rocket - Ovetto - Nitro 50 (97-99) - Evolis (92-96) - Fizz - Forte YAMAHA : Axis 50 (95-96)-Aerox - Breeze - Spy - Neo'S - Bw'S Bump - Original - NG	-
	● 12 - 24 - 6 (61901-2RS1-3HT)	10 020 0010	Puleggia condotta <i>Driven pulley</i>	Motori Scooter 50: MINARELLI - MBK - YAMAHA - PIAGGIO - GILERA	(R.O. 289953)
	● 12 - 32 - 10 (6201-2RSH)	10 020 0360	Ruota anteriore <i>Front Wheel</i>	MBK : 125-150 YAMAHA : 50-80-125-150 PIAGGIO : Vespa Px 125-150-200	(R.O. 007135)
	● 12 - 32 - 10 (6201-LL5/SKU)	10 020 0362	Ruota anteriore <i>Front Wheel</i>	MBK : 125-150 YAMAHA : 50-80-125-150 PIAGGIO : Vespa Px 125-150-200	(R.O. 007135)
	● 15 - 32 - 9 (6002-2RSH)	10 020 0040	Puleggia condotta <i>Driven pulley</i>	PIAGGIO - GILERA : Sfera Base 50 (91) - Zip Base 50 (92) - Skr city 80 - Sfera 125 (95) - Liberty 125 - Hexagon Lx4 125 - Et4 125	(R.O.285007)
	● 15 - 32 - 9 (6002-LLU)	10 020 0042	Puleggia condotta <i>Driven pulley</i>	PIAGGIO - GILERA : Sfera Base 50 (91) - Zip Base 50 (92) - Skr city 80 - Sfera 125 (95) - Liberty 125 - Hexagon Lx4 125 - Et4 125	-
	● 15 - 35 - 11 (6202-2RSH)	10 020 0370	Tamburo anteriore <i>Front Drum</i>	PIAGGIO : Vespa Px 125-150-200 - Arcobaleno	(R.O. 177610)
	● 15 - 42 - 13 (6302-2RS1)	10 020 0440	Ruota posteriore <i>Rear wheel</i>	PIAGGIO : Vespa Px 125-150-200 - Arcobaleno	(R.O. 235834)
	● 17 - 30 - 7 (61903-2RS1)	10 020 0060	Puleggia condotta <i>Driven pulley</i>	PIAGGIO - GILERA : Typhoon 125 - Runner FX - Fxr 125-180 - Skipper 125-150 - Lx 125-150 - Hexagon 125-150 - Lx/Lxt 125/180	(R.O. 431069)
	● 17 - 35 - 10 (6003-2RSH)	10 020 0070	Puleggia condotta <i>Driven pulley</i>	PIAGGIO - GILERA : Typhoon 125 - Runner Lx - Lxt 125-180 - Skipper 125-150 - Lx 125-150 - Hexagon 125-150 - Lx/Lxt 125/180	(R.O. 431068)
	● 17 - 40 - 12 (6203-2RS1)	10 020 0380	Supporto motore <i>Engine Mounting</i>	Motori Scooter 50: MINARELLI - MBK - YAMAHA	-
	● 17 - 47 - 14 (BB1-0683-2RS1)	10 020 0100	Albero primario <i>Driven pulley shaft</i>	PIAGGIO - GILERA : Typhoon 125 - Runner Fx - Fxr 125-180 - Sfera 125 - Liberty 125 - Et4 125 - Skipper 125-150 - Lx 125-150 - Hexagon Lx4 125-150 - Lx - Lxt 125-180	(R.O. 432305)
	● 20 - 42 - 12 (6004-2RSH/C3)	10 020 0530	Varie <i>Various</i>	-	-
	● 20 - 47 - 14 (BB1-0843)	10 020 0130	Albero ruota posteriore <i>Rear wheel axle</i>	PIAGGIO - GILERA : Scooter 50-80 - Typhoon 125 - Runner Fx/Fxr 125-180 - Hexagon Lx4 125 - Liberty 125 - Et4 - Sfera 125 - Hexagon 125-150 - Lx/Lxt 125-180 - Skipper 125-150 - Lx 125-150 PIAGGIO : Vespa 50-125-Pk XL-Rush-N-FL 50-125-Px-Ts-Pxe 125-150-200-Arc-Cosa 1-2 PIAGGIO : Ape P50 - FL - FL2 - FL3 Europa - Rst mix	(R.O. 434735) (R.O. 434735) (R.O. 434735)
	● 25 - 47 - 12 2RSH	10 020 0800	Ruota anteriore/posteriore <i>Front/rear Wheel</i>	Moto Fuoristrada <i>Off Road Motorbikes</i>	-
	● 20 - 47 - 14 (6204-2RSH)	10 020 0600	Ruota posteriore <i>Rear Wheel</i>	PIAGGIO : Ape 50 P-Tmp FL-FL2-FL3 Europa-Rst Mix-Scooter 50-100: Hexagon 125-150-180 - Liberty-Sfera 125-Skipper 125-150-Vespa Et4-FL-Pk XL 125-Vespa Px-Cosa 125-150-200	(R.O. 43473T)

- Gabbia acciaio - *Steel cage*
- Gabbia nylon - *Nylon cage*

CUSCINETTI RADIALI A SFERE COPERTI DA DUE LATI 2RS1

DOUBLE RUBBER SEALS BALL BEARINGS 2RS1



CUSCINETTI RADIALI A SFERE COPERTI DA UN LATO RS1

SINGLE RUBBER SEALS BALL BEARINGS RS1

DATI TECNICI SUI CUSCINETTI - BALL BEARINGS SPECIFICATIONS



RS1 = Guarnizione strisciante di gomma sintetica, rinforzata da una rosetta di lamiera ad un lato del cuscinetto - *Single rubber seals ball bearings*

	● 10 - 30 - 9 (6200-RS1)	10 020 0210	Asse ruota anteriore <i>Front wheel axle</i>	MALAGUTI: F10 92-99 - Yesterday 97-99	
	● 12 - 32 - 10 (6201-RS1)	10 020 0030	Asse ruota anteriore <i>Front wheel axle</i>	HONDA: SH 50 (96>) - Sky - Vision - Pk 50 Wallaro MALAGUTI: F12 50-100 (94-99)-Crosser - F15 (96-99) - Centro (94-99) - Ciak MBK: Flipper 50 (98-99) - Flame 125 (98-99) - Vertex 150 - Skyliner 125 YAMAHA: Why 50 (98-99)-Majesty 125 (98-99)-Cygnus 125 (95-98)-Flyone 150 (90-98)-Beluga 125 (90-95)	(R.O.96140-62000-10)
	● 15 - 35 - 11 (6202-RSH)	10 020 0050	Tamburo freno ant. e mozzo ant. <i>Front brake drum and front hub</i>	PIAGGIO: Sfera Rst 50 - Sfera 125 - Quartz 50 - Zip SP 50 - Skipper 125-150 - Hexagon Lx4 125 - Lx/Lxt 125-180-250 - Hexagon 125-150 - Et2/Et4 125-150 - Vespa Pk 50-125 - Pk XL Rush - N - FL - FL2 - Px T5 125-150-200 e Arcobaleno - Cosa ½	(R.O.177610)
	● 17 - 40 - 12 (6203-RS1)	10 020 0260	Albero ruota posteriore <i>Rear wheel axle</i>	Motori Scooter 50: MINARELLI - MBK - YAMAHA	

CUSCINETTO A RULLI - ROLLER BEARINGS



	● 25 - 38 - 15	10 019 0010	Albero motore - <i>Crank shaft</i>	PIAGGIO: Cosa 1-Cosa 2-FL 125 (89) - Vespa PX -PXE ARC. 125/150/200	(R.O. 133068)
--	-----------------------	--------------------	------------------------------------	---	---------------



ASTUCCI A RULLI - GABBIE A RULLI

DRAWN CUPS - ROLLER CAGES

ASTUCCI A RULLI APERTI DA UN LATO - DRAWN CUPS ONE SIDE OPEN

2RS1 = Guarnizione strisciante di gomma sintetica, rinforzata da una rosetta di lamiera sui due lati del cuscinetto - Double rubber seals ball bearings

TOLLERANZA INTERNA - CLEARANCE

C1: Tolleranza inferiore a C2 - Clearance inferior than C2 - C2: Tolleranza inferiore al normale - Clearance inferior than standard

C3: Tolleranza maggiore del normale - Clearance superior than standard - 4: Tolleranza maggiore di C3 - Clearance superior than C3

C5: Tolleranza maggiore di C4 - Clearance superior than C4

CODICE RMS RMS CODE	MODELLO - TRADE MARK	CODICE ORIGINALE ORIGINAL CODE
10 015 1000	Misura: Ø 12x18x12 Carter motore • <i>Crank case</i> : Vespa N Asse ruota post. • <i>Wheel axle</i> : Sfera Quartz • Free • Zip Fast Rider • Typhoon • Storm • Sfera Maquillage Mozzo ruota post. • <i>Wheel axle</i> : Bravo 3 • Superbravo 3	(R.O. 224309)
10 015 1190	Misura: Ø 16x14,3 Perno sospensione • <i>Suspension pin</i> : Vespa Px 125-150 • P 200e Vnx-Vlx-Vbx • Vespa Pk 125 XL Vmx6t	(R.O. 137146)
10 015 1200	Misura: Ø 12x12 Perno sospensione • <i>Suspension pin</i> : Vespa Px 125	(R.O. 174099)
ASTUCCI A RULLI APERTI DA AMBO I LATI - DRAWN CUPS TWO SIDES OPEN		
10 015 1100	Misura: Ø 12x18x12 Albero trasmissione mozzo posteriore • <i>Rear wheel axle</i> : Easy Moving • Free • Free FL • Nrg • Nrg Rst • Ntt • Quartz 50 • Sfera Rst 50	(R.O. 130491)
10 015 1110	Misura: Ø 18x24x16 Perno molleggio • <i>Pin Suspension arm</i> : Vespa 50 - 90 - 125	(R.O. 090457)
10 015 1120	Misura: Ø 22x28x12 Mozzo anteriore • <i>Front brake drum</i> : Vespa 50 - FL • Hp • Sfera 50 • Sfera Maquillage • Quartz • Zip Sp • Vespa Et4 • Skipper • Hexagon	(R.O. 177436)
10 015 1130	Misura: Ø 20x26x16 Mozzo anteriore • <i>Front brake drum</i> : Vespa 50 - FL • Hp • Vespa N • Vespa Px • Cosa • Cosa 1-2 • Sfera 50 • Maquillage • Quartz • Zip Sp Vespa Et4 • Skipper • Hexagon	(R.O. 177442)
10 015 1140	Misura: Ø 16x22x22 Campana frizione • <i>Pulley</i> : Ciao Sc • R • Px • P • Si • Boxer • Bravo	(R.O. 120668)
10 015 1150	Misura: Ø 28,5x35x12 Albero secondario • <i>Driven shaft</i> : Vespa Px 125 E • Px 150 E • Px 200 E • T5 • Ape Mp • Ape P601 prima serie	(R.O. 106956)
10 015 1170	Misura: Ø 25x33x18 Puleggia fissa frizione posteriore • <i>Driven pulley</i> : Piaggio 400: Beverly Eu 3 06-07 • Mp3 07 • X Evo 07-08 • X8 Eu 3 06-08 500 : Beverly 02-06 • Eu 3 06-08 • Cruiser 07 • X9 01-02 • Evolution 03-07 • Evolution Abs 06-07	(R.O. 829808)
10 015 1180	Misura: Ø 12x20x12 Vespa 150 GL • Sprint • Super Vla • Vlb • Vbc	(R.O. 152387)
10 015 1210	Misura: Ø 16x12 Vespa 50-90-125 Primavera Et3 • Pk • Pk XL • FL • Rush • N	(R.O. 137731)
10 015 1230	Misura: HK Ø 20x12 Mozz ruota post. • <i>Rear wheel axle</i> : Boss • Bravo • Ciao • Grillo • Si • Superbravo	(R.O. 131509)
10 015 1240	Misura: BK Ø 15x12 Mozz ruota post. • <i>Rear wheel axle</i> : Boss • Bravo • Ciao • Grillo • Si • Superbravo	(R.O. 103689)
10 015 1250	Misura: HK Ø 13x12 Mozz ruota post. • <i>Rear wheel axle</i> : Boss • Bravo • Ciao • Grillo • Si • Superbravo	(R.O. 103614)
10 015 1260	Misura: BK0912 Mozz ruota post. • <i>Rear wheel axle</i> : Boss • Bravo • Ciao • Grillo • Si • Superbravo	(R.O. 103613)
10 015 1270	Misura: HK Ø 17x12 Mozz ruota post. • <i>Rear wheel axle</i> : Bravo • Ciao • Grillo • Si	(R.O. 103696)
10 015 1280	Misura: HK Ø 14x12 Mozz ruota post. • <i>Rear wheel axle</i> : Boss • Grillo • Si Albero secondari: Vespa FL2 Aut. • Vespa Pk Aut. • Vesp Pk XL Plurimatic Dispositivo anti rollio Mp3 Ibrido 125 • Mp3 Mic 250 • Mp3 300	(R.O. 122671)
10 015 1290	Misura: HK Ø 16x16 Mozz ruota post. • <i>Rear wheel axle</i> : Vespa Px • Pe	(R.O. 174710)
GABBIE A RULLI - ROLLER CAGES		
10 015 0010	"DURKOP" per spinotto • <i>for piston pin Ø 10x14x13</i> adatt. a: APRILIA : Amico - Sr • Scarabeo • HONDA : Vision • MALAGUTI : F10 • 12 Centro • MBK : Booster • Active Sorriso • Evolis • Fizz PEUGEOT : Rapido • Metropolis • SUZUKI : Cs • Cp 50 • YAMAHA : Ct 50 • Jog • Breeze	
10 015 0050	"DURKOP" per spinotto • <i>for piston pin Ø 10x13x14,5</i> Ciao • Si	(R.O. 500521)
10 015 0150	"DURKOP" per spinotto • <i>for piston pin Ø 12x15x15</i> Fantic • Minarelli • Benelli	
10 015 0250	"DURKOP" per spinotto • <i>for piston pin Ø 12x17x15 Vespa</i>	
10 015 0300	"DURKOP" per spinotto • <i>for piston pin Ø 12x17x13</i> Vespa PK 50/XL - Sfera	(R.O. 500501)
10 015 0400	"DURKOP" per spinotto • <i>for piston pin Ø 15x19x20</i> Vespa ET3/PX/PK - Sachs	(R.O. 500541)
10 015 0450	"DURKOP" per spinotto • <i>for piston pin Ø 16x20x20</i> FBM 125 - Ape	(R.O. 500511)
10 015 0500	"DURKOP" per spinotto • <i>for piston pin Ø 18x23x20</i> Ape MP / TM / Car	(R.O. 500531)
GABBIA A RULLI INGRANAGGIO AVVIAMENTO - ROLLER CAGE STARTER GEAR		
10 015 0600	MALAGUTI - MBK - YAMAHA 50	

KIT REVISIONE ALBERO MOTORE 50-125-150-200-250 CC
CRANKSHAFT SERVICING KIT 50-125-150-200-250 CC

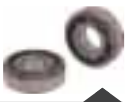

10 020 0770 

PIAGGIO: Ape 50

1	Cuscinetto - <i>Bearing</i> SKF	17-47-14		
1	Cuscinetto - <i>Bearing</i> SKF	20-47-14		
1	Paraolio - <i>Oil seal</i>		22,7-47-7/7,5	
1	Paraolio - <i>Oil seal</i>		20-32-7	

10 020 0760 

PIAGGIO: Vespa Et3 • Primavera 125

1	Cuscinetto - <i>Bearing</i> SKF	17-47-14		
1	Cuscinetto - <i>Bearing</i> SKF	20-47-14		
1	Paraolio - <i>Oil seal</i>		22,7-47-7/7,5	
1	Paraolio - <i>Oil seal</i>		19-32-7	

10 020 0780 

PIAGGIO: Ciclomotore

2	Cuscinetti - <i>Bearings</i> SKF	15-35-11		
1	Paraolio - <i>Oil seal</i>		15-24-5	

10 020 0682 

PIAGGIO SCOOTER 125: Vespa Et4

2	Cuscinetti - <i>Bearings</i> NTN		20-68-12	
	Gabbia acciaio - <i>Steel cage</i>			
1	Paraolio - <i>Oil seal</i>		18-28-7	
1	Paraolio - <i>Oil seal</i>		22-32-7	

10 020 0743 

PIAGGIO: Vespa GL • Sprint-Super • Gtr 150

2	Cuscinetti - <i>Bearings</i>		25-62-12	
1	Paraolio - <i>Oil seal</i>		20-40/60-6	
1	Paraolio - <i>Oil seal</i>		20-62-6,5	

10 020 0692 

HONDA 125-150: Sh

2	Cuscinetti - <i>Bearings</i> NTN		35-72-17	
	Gabbia acciaio - <i>Steel cage</i>			
2	Cuscinetti - <i>Bearings</i> NTN		35-72-15	
	Gabbia acciaio - <i>Steel cage</i>			
1	Paraolio - <i>Oil seal</i>		20.8-53-6.9	

10 020 0702 

SUZUKI 125-150: Epicuro 99-01 • Burgman 02-08 • Sixteen 08
200: Burgman 07-08 • **250:** Burgman 98-06 • **400:** Burgman 99-08

2	Cuscinetti - <i>Bearings</i> NTN		35-72-17	
	Gabbia acciaio - <i>Steel cage</i>			
1	Paraolio - <i>Oil seal</i>		34-52-5.8	

10 020 0712 

GILERA 125-180: Runner 2T 97-02 • **125:** Typhoon X • Xr 95-00
PIAGGIO 125-150: Hexagon 94-97 • **125-180:** Hexagon Lx • Lxt 98-99
125-150: Skipper 94-97 • Lx 98-99

2	Cuscinetti - <i>Bearings</i> NTN			
	Gabbia acciaio - <i>Steel cage</i>		25-68-12	
2	Paraolio - <i>Oil seal</i>		24-35-7	



KIT REVISIONE ALBERO MOTORE 50-125-150-200-250 CC
CRANKSHAFT SERVICING KIT 50-125-150-200-250 CC

10 020 0300

GILERA PIAGGIO SCOOTER 50

2	Cuscinetti - Bearings SKF			
	gabbia in Nylon Polyamid cage	20-52-12		
1	Paraolio - Oil seal		18-28-7	
1	Paraolio - Oil seal		19-30-7	

10 020 0310

GILERA PIAGGIO SCOOTER 50

2	Cuscinetti - Bearings SKF	20-52-12		
	Gabbia in Acciaio - Steel cage			
1	Paraolio - Oil seal		18-28-7	
1	Paraolio - Oil seal		19-30-7	

10 020 0312

GILERA PIAGGIO SCOOTER 50

2	Cuscinetti - Bearings NTN			
	Gabbia acciaio - Steel cage	20-52-12		
1	Paraolio - Oil seal		18-28-7	
1	Paraolio - Oil seal		19-30-7	

10 020 0492

MINARELLI-MBK-YAMAHA 50

2	Cuscinetti - Bearings NTN	20-47-14		
	Gabbia acciaio - Steel cage			
1	Paraolio - Oil seal		20-30/33,5-5,3-6	
1	Paraolio - Oil seal		20-42/43-8/9	

10 020 0320

MINARELLI - YAMAHA 50

2	Cuscinetti - Bearings SKF	20-47-14		
	Gabbia in Nylon - Polyamid cage			
1	Paraolio - Oil seal		20-30/33,5-5,3-6	
1	Paraolio - Oil seal		20-42/43-8-9	

10 020 0340

MINARELLI-MBK-YAMAHA 50

2	Cuscinetti - Bearings KOYO	20-47-14		
	Gabbia acciaio - Steel cage			
1	Paraolio - Oil seal		20-30/33,5-5,3/6	
1	Paraolio - Oil seal		20-42/43-8/9	

10 020 0560

MOTORI MINARELLI 50: Am 345-Am6

2	Cuscinetti - Bearings SKF 6303 TN9C3	17-47-14		
1	Paraolio - Oil seal		17-35-8	
1	Paraolio - Oil seal		24-35-7	

10 020 0400

MOTORI - F. MORINI - APRILIA - ITALJET - MALAGUTI - SUZUKI

1	Cuscinetto - Bearing SKF 6204TN9 - C4HLHT23	20-47-14		
	Gabbia in Nylon - Polyamid cage			
1	Cuscinetto - Bearing SKF BB1-3056C	25-52-13		
	Gabbia in Acciaio - Steel cage			
1	Paraolio - Oil seals		17-27-6	
1	Paraolio - Oil seals		25-37-6	
1	Paraolio - Oil seals		24-43-6	

KIT REVISIONE ALBERO MOTORE 50-125-150-200-250 CC

CRANKSHAFT SERVICING KIT 50-125-150-200-250 CC



10 020 0610

PEUGEOT 50: Buxy 94-97 • Elyseo 99 • Looxor 01-03 • Metal X 02 • Speedake 95-97 • Speed Fight acqua/aria 97-98 • Aria Kat 99 • Squab 95-97 • Sv Geo 91-95 • Trekker 98-00 • Vivacity 99 • Kat 99-02 • Vsx-Xr02-04 • X Fight 00 • X Race 03 • Zenith L 94-96 • Ln-Ls-N 97-98

2	Cuscinetti - <i>Bearings</i> SKF	20-52-12	
1	Paraolio - <i>Oil seals</i>	15,6-25,6-7	
1	Paraolio - <i>Oil seals</i>	20-30-7	

10 020 0620

PEUGEOT 50: Speed Fight 2 aria • 2LC307WRC • Silver 05-06 • TRK2WRC 04-06

1	Cuscinetto - <i>Bearing</i> SKF	20-47-14	
	6204 C4 MT Gabbia acciaio <i>Steel cage</i>		
1	Cuscinetto - <i>Bearing</i> SKF	20-52-12	
	BB1 3055B Gabbia acciaio <i>Steel cage</i>		
1	Paraolio - <i>Oil seals</i>	15,6-25,6-7	
1	Paraolio - <i>Oil seals</i>	20-30-7	

10 020 0750

PIAGGIO 50-90: Vespa V5Al-V5A2T-V5BIT-V5B3T-V9Al

1	Cuscinetto - <i>Bearing</i> SKF	17-47-14	
1	Cuscinetto - <i>Bearing</i> SKF	20-47-14	
1	Paraolio - <i>Oil seals</i>	22,7-47-7/7.5	
1	Paraolio - <i>Oil seals</i>	19-32-7	

10 020 0730

PIAGGIO: Vespa Px-Pe 125-150-200

1	Cuscinetto - <i>Bearing</i> SKF	25-62-12	
	Gabbia acciaio - <i>Steel cage</i>		
1	Cuscinetto - <i>Bearing</i>	25-38-15	
1	Paraolio - <i>Oil seals</i>	24-35-6	
1	Paraolio - <i>Oil seals</i>	31-62-4.3/5.8	

10 020 0740

PIAGGIO: Vespa Px-Pe 125-150-200

1	Cuscinetto - <i>Bearing</i>	25-62-12	
	Gabbia acciaio - <i>Steel cage</i>		
1	Cuscinetto - <i>Bearing</i>	25-38-15	
1	Paraolio - <i>Oil seals</i>	24-35-6	
1	Paraolio - <i>Oil seals</i>	31-62-4.3/5.8	

10 020 0790

PIAGGIO 50: Vespa Pk XL V5X3

1	Cuscinetto - <i>Bearing</i> SKF	17-47-14	
1	Cuscinetto - <i>Bearing</i> SKF	20-47-14	
1	Paraolio - <i>Oil seals</i>	22,7-47-7/7.5	
1	Paraolio - <i>Oil seals</i>	20-47-14	

10 020 0810

PIAGGIO 50: Vespa

1	Cuscinetto - <i>Bearing</i>	20-47-14	
1	Cuscinetto - <i>Bearing</i>	17-47-14	
1	Paraolio - <i>Oil seals</i>	22,7-47-7/7,5	
1	Paraolio - <i>Oil seals</i>	19-32-7	
1	Paraolio - <i>Oil seals</i>	27-37-7	
1	Anello - <i>O Ring</i>	15,88-2,62	
1	Anello - <i>O Ring</i>	6,75-2	
2	Anello - <i>O Ring</i>		
1	Anello - <i>O Ring</i>	8,73-1,78	

10 020 0820

PIAGGIO 50-125: Vespa Pk

1	Cuscinetto - <i>Bearing</i>	20-47-14	
1	Cuscinetto - <i>Bearing</i>	17-47-14	
1	Paraolio - <i>Oil Seal</i>	22,7-47-7/7,5	
1	Paraolio - <i>Oil Seal</i>	20-32-7	
1	Paraolio - <i>Oil Seal</i>	27-37-7	
1	Anello - <i>O Ring</i>	15,88-2,62	
1	Anello - <i>O Ring</i>	6,75-2	
2	Anello - <i>O Ring</i>		
1	Anello - <i>O Ring</i>	8,73-1,78	

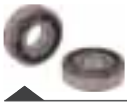

KIT REVISIONE ALBERO MOTORE 50-125-150-200-250 CC
CRANKSHAFT SERVICING KIT 50-125-150-200-250 CC

10 020 0830 

PIAGGIO 125: Vespa Primavera Et3

1	Cuscinetto - <i>Bearing</i>	20-47-14
1	Cuscinetto - <i>Bearing</i>	17-47-14
1	Paraolio - <i>Oil seal</i>	22,7-47-7/7,5
1	Paraolio - <i>Oil seal</i>	19-32-7
1	Paraolio - <i>Oil seal</i>	30-47-6
1	Anello - <i>O Ring</i>	15,88-2,62
1	Anello - <i>O Ring</i>	6,75-2
2	Anello - <i>O Ring</i>	
1	Anello - <i>O Ring</i>	8,73-1,78



10 020 0840 

PIAGGIO 125-150-200: Vespa Px

1	Cuscinetto - <i>Bearing</i>	25-38-15
1	Cuscinetto - <i>Bearing</i>	25-62-12
1	Paraolio - <i>Oil seal</i>	24-35-6
1	Paraolio - <i>Oil seal</i>	31-62-4,3/5,8
1	Paraolio - <i>Oil seal</i>	27-47-6
1	Anello - <i>O Ring</i>	15,88-2,62
1	Anello - <i>O Ring</i>	6,75-2
1	Anello - <i>O Ring</i>	11,11-1,78
1	Anello - <i>O Ring</i>	123-2,1



10 020 0850 

PIAGGIO: Vespa Sprint GL

2	Cuscinetti - <i>Bearings</i>	25-62-12
1	Paraolio - <i>Oil seal</i>	20-62-6,5
1	Paraolio - <i>Oil seal</i>	20-40/60-6
1	Paraolio - <i>Oil seal</i>	27-37-7
1	Anello - <i>O Ring</i>	15,88-2,62
1	Anello - <i>O Ring</i>	6,75-2
1	Anello - <i>O Ring</i>	11,11-1,78
1	Anello - <i>O Ring</i>	123-2,1



10 020 0860 

PIAGGIO: Vespa Pxe Arcobaleno

1	Cuscinetto - <i>Bearing</i>	25-38-15
1	Cuscinetto - <i>Bearing</i>	25-62-12
1	Paraolio - <i>Oil seal</i>	31-62-4,3/5,8
1	Paraolio - <i>Oil seal</i>	24-35-6
1	Paraolio - <i>Oil seal</i>	30-47-6
1	Anello - <i>O Ring</i>	15,88-2,62
1	Anello - <i>O Ring</i>	6,75-2
1	Anello - <i>O Ring</i>	11,11-1,78
1	Anello - <i>O Ring</i>	123-2,1





APRILIA

10 064 1010

APPLICAZIONI - APPLICATIONS	COMPOSIZIONE - COMPOSITION	MISURE - MEASURES	Q.tà	CODICE - RMS CODE
50: Amico SR 94 Motori Minarelli MY Raffreddati ad aria Motori Minarelli MA Raffreddati a liquido <i>Minarelli engine MY aircooled</i> <i>Minarelli engine MA liquid cooled</i> (Confezione 5 pz - Packaging 5 pcs)	Albero motore lato volano - <i>Flywheel side</i>	20x30/33.5x5.3/6	1	10 066 1900
	Statore volano - <i>Flywheel</i>	19x26x5	1	
	Albero motore lato frizione - <i>Clutch side</i>	20x42/43x8/9	1	10 066 2300
	Albero primario - <i>Drive shaft</i>	17x28x5.5	1	10 066 0870
	Puleggia frizione posteriore mobile - <i>Rear Pulley</i>	33x39x4	2	
	Albero trasmissione ruota posteriore <i>Rear wheel shaft</i>	22x32x6	1	
	O-Ring motorino avviamento - <i>Starter Motor</i>	21.95x1.78	1	
	O-Ring puleggia frizione posteriore mobile- <i>Rear Pulley</i>	37.82x1.78	2	
	O-Ring tappo olio motore - <i>Oil tank</i>	13.8x2.4	1	
	Ruota anteriore - <i>Front wheel</i>	40x52x6	1	
Ruota anteriore - <i>Front wheel</i>	20x35x7/11	1		

10 064 1070

APPLICAZIONI - APPLICATIONS	COMPOSIZIONE - COMPOSITION	MISURE - MEASURES	Q.tà	CODICE - RMS CODE
50: Amico SR 94 Motori Minarelli MY Raffreddati ad aria Motori Minarelli MA Raffreddati a liquido <i>Minarelli engine MY aircooled</i> <i>Minarelli engine MA liquid cooled</i> (Confezione 10 pz - Packaging 10 pcs)	Albero motore lato volano - <i>Flywheel side</i>	20x30/33.5x5.3/6	1	10 066 1900
	Albero motore lato frizione - <i>Clutch side</i>	20x42/43x8/9	1	10 066 2300
	Albero primario - <i>Drive shaft</i>	17x28x5.5	1	10 066 0870
	Albero ruota posteriore - <i>Rear Wheel Shaft</i>	22x32x6	1	

ATALA

10 064 1020

APPLICAZIONI - APPLICATIONS	COMPOSIZIONE - COMPOSITION	MISURE - MEASURES	Q.tà	CODICE - RMS CODE
50: Hacker Motore F. Morini - AH L raffr. Aria (Confezione 10 pz - Packaging 10 pcs)	Albero motore lato volano - <i>Flywheel side</i>	16.5x27x6	1	10 066 0780
	Albero motore lato frizione - <i>Clutch side</i>	25x37x6	1	10 066 3600
	Ingranaggio pompa - <i>Pump gear</i>	24x43x6	1	
	Albero primario - <i>Drive shaft</i>	15.9x27x5	1	
	Albero ruota posteriore - <i>Rear Wheel Shaft</i>	27x40x6	1	

GILERA

10 064 0020

APPLICAZIONI - APPLICATIONS	COMPOSIZIONE - COMPOSITION	MISURE - MEASURES	Q.tà	CODICE - RMS CODE
50: Stalker - Runner (Confezione 5 pz - Packaging 5 pcs)	Albero motore lato volano - <i>Flywheel side</i>	18x28x7	1	10 066 1400
	Albero motore lato frizione - <i>Clutch side</i>	19x30x7	1	10 066 1600
	Puleggia frizione posteriore mobile - <i>Rear Pulley</i>	34x39x3	2	
	Albero primario - <i>Drive shaft</i>	17x28x5	1	
	Albero ruota posteriore - <i>Rear Wheel Shaft</i>	30x47x6	1	10 066 5500
	O-Ring puleggia frizione posteriore mobile - <i>Rear Pulley</i>	39,5x2	2	
	O-Ring frizione anteriore - <i>Front rear pulley</i>	88,62x1,78	1	
	O-Ring tappo olio - <i>O-Ring Oil</i>	11x1,9	1	



SERIE PARAOLIO MOTORE - RICERCA PER MARCA
OIL SEAL KIT - ALPHABETICAL ORDER

HONDA

10 064 1300 

APPLICAZIONI - APPLICATIONS	COMPOSIZIONE - COMPOSITION	MISURE - MEASURES	Q.tà	CODICE - RMS CODE
50: Sky - Sh 96 - X8r (Confezione 10 pz - Packaging 10 pcs)	Albero motore lato volano - <i>Flywheel side</i>	15x30x7	1	
	Albero motore lato frizione - <i>Clutch side</i>	20x31x7	1	10 066 1950
	Albero primario - <i>Drive shaft</i>	17x30x6	1	
	Albero ruota posteriore - <i>Rear Wheel Shaft</i>	26x42x7	1	
	Puleggia frizione posteriore mobile - <i>Rear Pulley</i>	34x39x3	2	
	O-Ring puleggia frizione posteriore - <i>Rear Pulley</i>	36x1,5	1	
	O-Ring puleggia frizione posteriore mobile - <i>Rear Pulley</i>	39,8x2,2	1	
	O-Ring pompa olio - <i>Oil Pump</i>	18,3x2,3	1	
	O-Ring collettore aspirazione - <i>Inlet Pipes</i>	20,6x1,9	1	

ITALJET

10 064 1020 

APPLICAZIONI - APPLICATIONS	COMPOSIZIONE - COMPOSITION	MISURE - MEASURES	Q.tà	CODICE - RMS CODE
50: Formula (Confezione 10 pz - Packaging 10 pcs)	Albero motore lato volano - <i>Flywheel side</i>	16,5x27x6	1	10 066 0780
	Albero motore lato frizione - <i>Clutch side</i>	25x37x6	1	10 066 3600
	Ingranaggio pompa - <i>Pump gear</i>	24x43x6	1	
	Albero primario - <i>Drive shaft</i>	15,9x27x5	1	
	Albero trasmissione ruota posteriore <i>Rear wheel shaft</i>	27x40x6	1	

MALAGUTI

10 064 1010 

APPLICAZIONI - APPLICATIONS	COMPOSIZIONE - COMPOSITION	MISURE - MEASURES	Q.tà	CODICE - RMS CODE
50: F10 - F12 Phantom Centro SL Raffr. Aria - F12 - F15 Raffr. Acqua (Confezione 5 pz - Packaging 5 pcs)	Albero motore lato volano - <i>Flywheel side</i>	20x30/33,5x5,3/6	1	10 066 1900
	Statore volano - <i>Flywheel</i>	19x26x5	1	
	Albero motore lato frizione - <i>Clutch side</i>	20x42/43x8/9	1	10 066 2300
	Albero primario - <i>Drive shaft</i>	17x28x5,5	1	10 066 0870
	Puleggia frizione posteriore mobile - <i>Rear Pulley</i>	33x39x4	2	
	Albero trasmissione ruota posteriore <i>Rear wheel shaft</i>	22x32x6	1	
	O-Ring motorino avviamento - <i>Starter Motor</i>	21,95x1,78	1	
	O-Ring puleggia frizione posteriore mobile - <i>Rear Pulley</i>	37,82x1,78	2	
	O-Ring tappo olio motore - <i>Oil tank</i>	13,8x2,4	1	
	Ruota anteriore - <i>Front wheel</i>	40x52x6	1	
	Ruota anteriore - <i>Front wheel</i>	20x35x7/11	1	

10 064 1020 

APPLICAZIONI - APPLICATIONS	COMPOSIZIONE - COMPOSITION	MISURE - MEASURES	Q.tà	CODICE - RMS CODE
50: Crossover (Confezione 10 pz - Packaging 10 pcs)	Albero motore lato volano - <i>Flywheel side</i>	17x27x6	1	10 066 0780
	Albero motore lato frizione - <i>Clutch side</i>	25x37x6	1	10 066 3600
	Ingranaggio pompa - <i>Pump gear</i>	24x43x6	1	
	Albero primario - <i>Drive shaft</i>	17x27x5	1	
	Albero trasmissione ruota posteriore <i>Rear wheel shaft</i>	27x40x6	1	



MALAGUTI

10 064 1070 

APPLICAZIONI - APPLICATIONS	COMPOSIZIONE - COMPOSITION	MISURE - MEASURES	Q.tà	CODICE - RMS CODE
50: F10 - F12 Phantom Centro SL raffr. Aria-F12 - F15 Raffr. acqua (Confezione 10 pz - Packaging 10 pcs)	Albero motore lato volano - <i>Flywheel side</i>	20x30/33.5x5.3/6	1	10 066 1900
	Albero motore lato frizione - <i>Clutch side</i>	20x42/43x8/9	1	10 066 2300
	Albero primario - <i>Drive shaft</i>	17x28x5.5	1	10 066 0870
	Albero ruota posteriore - <i>Rear Wheel Shaft</i>	22x32x6	1	

MBK

10 064 1010 

APPLICAZIONI - APPLICATIONS	COMPOSIZIONE - COMPOSITION	MISURE - MEASURES	Q.tà	CODICE - RMS CODE
50: Booster (Confezione 5 pz - Packaging 5 pcs)	Albero ero motore lato volano - <i>Flywheel side</i>	20x30/33.5x5.3/6	1	10 066 1900
	Statore volano - <i>Flywheel</i>	19x26x5	1	
	Albero motore lato frizione - <i>Clutch side</i>	20x42/43x8/9	1	10 066 2300
	Albero primario - <i>Drive shaft</i>	17x28x5.5	1	10 066 0870
	Puleggia frizione posteriore mobile - <i>Rear Pulley</i>	33x39x4	2	
	Albero trasmissione ruota posteriore <i>Rear wheel shaft</i>	22x32x6	1	
	O-Ring motorino avviamento - <i>Starter Motor</i>	21.95x1.78	1	
	O-Ring puleggia frizione posteriore mobile - <i>Rear Pulley</i>	37.82x1.78	2	
	O-Ring tappo olio motore - <i>Oil tank</i>	13.8x2.4	1	
	Ruota anteriore - <i>Front wheel</i>	40x52x6	1	
Ruota anteriore - <i>Front wheel</i>	20x35x7/11	1		

10 064 1070 

APPLICAZIONI - APPLICATIONS	COMPOSIZIONE - COMPOSITION	MISURE - MEASURES	Q.tà	CODICE - RMS CODE
50: Booster (Confezione 10 pz - Packaging 10 pcs)	Albero motore lato volano - <i>Flywheel side</i>	20x30/33.5x5.3/6	1	10 066 1900
	Albero motore lato frizione - <i>Clutch side</i>	20x42/43x8/9	1	10 066 2300
	Albero primario - <i>Drive shaft</i>	17x28x5.5	1	10 066 0870
	Albero ruota posteriore - <i>Rear Wheel Shaft</i>	22x32x6	1	

PEUGEOT

10 064 1130 

APPLICAZIONI - APPLICATIONS	COMPOSIZIONE - COMPOSITION	MISURE - MEASURES	Q.tà	CODICE - RMS CODE
50: SV Zenith Buxy Speedake (Confezione 10 pz - Packaging 10 pcs)	Albero motore lato volano - <i>Flywheel side</i>	15.6x25.6x7	1	10 066 0600
	Albero motore lato frizione - <i>Clutch side</i>	20x30x7	1	10 066 1850
	Albero primario - <i>Drive shaft</i>	17x30x6	1	
	Puleggia frizione posteriore mobile - <i>Rear Pulley</i>	34x39x3	2	
	Albero ruota posteriore - <i>Rear Wheel Shaft</i>	26x42x7	1	
	O-Ring frizione - <i>Clutch</i>	78x1.5	1	
	O-Ring puleggia frizione mobile - <i>Pulley</i>	39.5x2	1	
O-Ring puleggia frizione mobile - <i>Pulley</i>	40x1.5	1		



SERIE PARAOLIO MOTORE - RICERCA PER MARCA
OIL SEAL KIT - ALPHABETICAL ORDER

PIAGGIO

10 064 0010

APPLICAZIONI - APPLICATIONS	COMPOSIZIONE - COMPOSITION	MISURE - MEASURES	Q.tà	CODICE - RMS CODE
50: Vespa ET2 (Confezione 5 pz - Packaging 5 pcs)	Albero motore lato volano - <i>Flywheel side</i>	18x28x7	1	10 066 1400
	Albero motore lato frizione - <i>Clutch side</i>	19x30x7	1	10 066 1600
	Puleggia frizione posteriore mobile - <i>Rear Pulley</i>	34x39x3	2	
	Albero primario - <i>Drive shaft</i>	22x40x7	1	
	Albero ruota posteriore - <i>Rear Wheel Shaft</i>	30x47x6	1	10 066 5500
	O-Ring puleggia frizione posteriore mobile - <i>Rear Pulley</i>	39,5x2	2	
	O-Ring frizione anteriore - <i>Front Pulley</i>	77,5x1,5	1	

10 064 0050

APPLICAZIONI - APPLICATIONS	COMPOSIZIONE - COMPOSITION	MISURE - MEASURES	Q.tà	CODICE - RMS CODE
50: Sfera '91-Zip '92 Raffr. Aria (Confezione 10 pz - Packaging 10 pcs)	Albero motore lato volano - <i>Flywheel side</i>	18x28x7	1	10 066 1400
	Albero motore lato frizione - <i>Clutch side</i>	19x30x6	1	10 066 1600
	Puleggia frizione posteriore mobile - <i>Rear Pulley</i>	40x47x4	2	10 066 8500
	Albero primario - <i>Drive shaft</i>	22x40x7	1	
	Albero ruota posteriore - <i>Rear Wheel Shaft</i>	30x47x6	1	10 066 5500

10 064 0060

APPLICAZIONI - APPLICATIONS	COMPOSIZIONE - COMPOSITION	MISURE - MEASURES	Q.tà	CODICE - RMS CODE
50: Zip '93-95-Free '92-Quartz '92-Sfera-Nrg - Ntt (Confezione 5 pz - Packaging 5 pcs)	Albero motore lato volano - <i>Flywheel side</i>	18x28x7	1	10 066 1400
	Albero motore lato frizione - <i>Clutch side</i>	19x30x7	1	10 066 1600
	Puleggia frizione posteriore mobile - <i>Rear Pulley</i>	34x39x3	2	
	Albero primario - <i>Drive shaft</i>	22x40x7	1	
	Albero ruota posteriore - <i>Rear Wheel Shaft</i>	30x47x6	1	10 066 5500
	Albero pompa acqua - <i>Water Pump shaft</i>	8x16x10/11	1	10 066 0050
	O-Ring puleggia frizione posteriore mobile <i>Rear Pulley</i>		2	
	O-Ring frizione anteriore - <i>Front Pulley</i>		1	

10 064 0080

APPLICAZIONI - APPLICATIONS	COMPOSIZIONE - COMPOSITION	MISURE - MEASURES	Q.tà	CODICE - RMS CODE
50: Liberty (Confezione 1 pz - Packaging 1 pc)	Albero motore lato volano - <i>Flywheel side</i>	18x28x7	1	10 066 1400
	Albero motore lato frizione - <i>Clutch side</i>	19x30x7	1	10 066 1600
	Puleggia frizione posteriore mobile - <i>Rear Pulley</i>	34x39x3	2	
	Albero primario - <i>Drive shaft</i>	17x28x6	1	
	Albero ruota posteriore - <i>Rear Wheel Shaft</i>	30x47x6	1	10 066 5500
	O-Ring puleggia frizione posteriore mobile - <i>Rear Pulley</i>	39,5x2	2	
	O-Ring frizione anteriore - <i>Front Pulley</i>	88,62x1,78	1	
	O-Ring tappo olio motore - <i>Oil Tank</i>	11x1,9	1	



PIAGGIO

10 064 0100

APPLICAZIONI - APPLICATIONS	COMPOSIZIONE - COMPOSITION	MISURE - MEASURES	Q.tà	CODICE - RMS CODE
125: Vespa ET4 (Confezione 1 pz - Packaging 1 pc)	Albero motore lato volano - <i>Flywheel side</i>	18x28x7	1	10 066 1400
	Albero motore lato frizione - <i>Clutch side</i>	22x32x7	1	10 066 2430
	Albero primario - <i>Drive shaft</i>	22.7x47.05x7.5/7	1	
	Albero ruota posteriore - <i>Rear Wheel Shaft</i>	30x47x6	1	10 066 5500
	O-Ring filtro olio - <i>Oil Filter</i>		1	
	O-Ring raccordo filtro olio - <i>Oil Filter Connection</i>		1	
	O-Ring coperchio pompa olio - <i>Oil Pump Cover</i>		1	
	O-Ring puleggia frizione posteriore Fissa - <i>Rear Pulley</i>		1	
	O-Ring filtro olio - <i>Oil Filter</i>		2	
	O-Ring frizione anteriore - <i>Front Pulley</i>		1	
	O-Ring tappo introduzione olio - <i>Oil tank</i>		1	

10 064 0110

APPLICAZIONI - APPLICATIONS	COMPOSIZIONE - COMPOSITION	MISURE - MEASURES	Q.tà	CODICE - RMS CODE
50-90-125: Vespa Primavera 50-125: Et3-Pk (Confezione 10 pz - Packaging 10 pcs)	Albero motore lato volano - <i>Flywheel side</i>	19x32x7	1	10 066 1700
	Albero motore lato frizione - <i>Clutch side</i>	22.7x47x7/7.5	1	10 066 2700
	Albero ruota posteriore - <i>Rear Wheel Shaft</i>	27x37x7	1	10 066 4500
	Anelli O-Ring		6	

10 064 0130

APPLICAZIONI - APPLICATIONS	COMPOSIZIONE - COMPOSITION	MISURE - MEASURES	Q.tà	CODICE - RMS CODE
50: Vespa Pk XL-FL2 (Confezione 10 pz - Packaging 10 pcs)	Albero motore lato volano - <i>Flywheel side</i>	20x32x7	1	10 066 2000
	Albero motore lato frizione - <i>Clutch side</i>	22.7x47x7/7.5	1	10 066 2700
	Albero ruota posteriore - <i>Rear Wheel Shaft</i>	27x37x7	1	10 066 4500
	Anelli O-Ring		6	

10 064 0140

APPLICAZIONI - APPLICATIONS	COMPOSIZIONE - COMPOSITION	MISURE - MEASURES	Q.tà	CODICE - RMS CODE
150: Vespa GL - Sprint (Confezione 1 pz - Packaging 1 pcs)	Albero motore lato frizione - <i>Clutch side</i>	20x40/60x56	1	
	Albero motore lato volano - <i>Flywheel side</i>	20x62x6,5	1	10 066 2360
	Albero ruota posteriore - <i>Rear Wheel Shaft</i>	27x37x7	1	10 066 4500

10 064 0160

APPLICAZIONI - APPLICATIONS	COMPOSIZIONE - COMPOSITION	MISURE - MEASURES	Q.tà	CODICE - RMS CODE
125-150: Vespa Px TS 200: Pe (Confezione 10 pz - Packaging 10 pcs)	Albero motore lato volano - <i>Flywheel side</i>	24x35x6	1	10 066 3000
	Albero motore lato frizione - <i>Clutch side</i>	31x62x4.3/5.8	1	10 066 6060
	Albero ruota posteriore - <i>Rear Wheel Shaft</i>	27x47x6	1	10 066 4800



SERIE PARAOLIO MOTORE - RICERCA PER MARCA
OIL SEAL KIT - ALPHABETICAL ORDER

PIAGGIO

10 064 0180

APPLICAZIONI - APPLICATIONS	COMPOSIZIONE - COMPOSITION	MISURE - MEASURES	Q.tà	CODICE - RMS CODE
125: Vespa T5 Cosa (Confezione 1 pz - Packaging 1 pcs)	Albero motore lato volano - <i>Flywheel side</i>	24x35x6	1	10 066 3000
	Albero motore lato frizione - <i>Clutch side</i>	31x62x4.3/5.8	1	10 066 6000
	Albero ruota posteriore - <i>Rear Wheel Shaft</i>	27x42x10	1	10 066 4700

10 064 0170

APPLICAZIONI - APPLICATIONS	COMPOSIZIONE - COMPOSITION	MISURE - MEASURES	Q.tà	CODICE - RMS CODE
125-150-200: Vespa-Px-Pe Arcobaleno (Confezione 10 pz - Packaging 10 pcs)	Albero motore lato volano - <i>Flywheel side</i>	24x35x6	1	10 066 3000
	Albero motore lato frizione - <i>Clutch side</i>	31x62x4.3/5.8	1	10 066 6000
	Albero ruota posteriore - <i>Rear Wheel Shaft</i>	30x47x6	1	10 066 5500

10 064 0200

APPLICAZIONI - APPLICATIONS	COMPOSIZIONE - COMPOSITION	MISURE - MEASURES	Q.tà	CODICE - RMS CODE
125-150: Hexagon (Confezione 1 pz - Packaging 1 pcs)	Albero motore - <i>Crankshaft</i>	24x35x7	2	10 066 3050
	Albero primario - <i>Drive shaft</i>	22.7x47x7/7.5	1	10 066 2700
	Albero ruota posteriore - <i>Rear Wheel Shaft</i>	30x47x6	1	10 066 5500
	Albero pompa acqua - <i>Water Pump Shaft</i>	8x16x10/11	1	10 066 0050
	O-Ring puleggia frizione - <i>Pulley</i>	21,9x2.62	1	
	O-Ring candela - <i>Spark plug</i>	13x1,8	1	
	Anelli O-Ring	23,47x2,62	1	

10 064 0240

APPLICAZIONI - APPLICATIONS	COMPOSIZIONE - COMPOSITION	MISURE - MEASURES	Q.tà	CODICE - RMS CODE
125-150-200: Vespa Px (Confezione 10 pz - Packaging 10 pcs)	Albero motore lato volano - <i>Flywheel side</i>	24x35x6	1	10 066 3000
	Albero motore lato frizione struttura Metallo <i>Clutch side metal frame</i>	31x62x4,3/5/8	1	10 066 6010
	Albero ruota posteriore - <i>Rear Wheel Shaft</i>	27x47x6	1	10 066 4800

10 064 0250

APPLICAZIONI - APPLICATIONS	COMPOSIZIONE - COMPOSITION	MISURE - MEASURES	Q.tà	CODICE - RMS CODE
125-150-200: Vespa Px Arcobaleno (Confezione 10 pz - Packaging 10 pcs)	Albero motore lato volano - <i>Flywheel side</i>	24x35x6	1	10 066 3000
	Albero motore lato frizione struttura Metallo <i>Clutch side metal frame</i>	31x62x4,3/5/8	1	10 066 6010
	Albero ruota posteriore - <i>Rear Wheel Shaft</i>	30x47x6	1	10 066 5500

10 064 0260

Blue

APPLICAZIONI - APPLICATIONS	COMPOSIZIONE - COMPOSITION	MISURE - MEASURES	Q.tà	CODICE - RMS CODE
125-150-200: Vespa Px (Confezione 10 pz - Packaging 10 pcs)	Albero motore lato volano - <i>Flywheel side</i>	24x35x6	1	
	Albero motore lato frizione struttura Metallo <i>Clutch side metal frame</i>	31x62x4,3/5/8	1	
	Albero ruota posteriore - <i>Rear Wheel Shaft</i>	27x47x6	1	



PIAGGIO

10 064 0270 

Blue

APPLICAZIONI - APPLICATIONS	COMPOSIZIONE - COMPOSITION	MISURE - MEASURES	Q.tà	CODICE - RMS CODE
125-150-200: Vespa Px Arcobaleno (Confezione 10 pz - Packaging 10 pcs)	Albero motore lato volano - <i>Flywheel side</i>	24x35x6	1	
	Albero motore lato frizione struttura Metallo <i>Clutch side metal frame</i>	31x62x4,3/5/8	1	
	Albero ruota posteriore - <i>Rear Wheel Shaft</i>	30x47x6	1	

YAMAHA

10 064 1080 

APPLICAZIONI - APPLICATIONS	COMPOSIZIONE - COMPOSITION	MISURE - MEASURES	Q.tà	CODICE - RMS CODE
MOTORI MINARELLI: Scooter 50 (Confezione 10 pz - Packaging 10 pcs)	Paraolio doppia tenuta - <i>Oil Seal special watertight</i>	10-18-5/8	1	
	Anello O-Ring	53,7x1,78	1	

10 064 1060 

APPLICAZIONI - APPLICATIONS	COMPOSIZIONE - COMPOSITION	MISURE - MEASURES	Q.tà	CODICE - RMS CODE
MOTORI MINARELLI: Scooter 50 (Confezione 10 pz - Packaging 10 pcs)	Paraolio - <i>Oil Seal</i>	10-18-4	1	10 066 0200
	Anello O-Ring	53,7x1,78	1	



PARAOLIO - RICERCA PER MISURA

OIL SEALS - SEARCH BY SIZE

MISURE SIZE	CODICE CODE	BARCODE	DESCRIZIONE DESCRIPTION	APPLICAZIONI APPLICATIONS	RIF. ORIGINALE OEM NUMBER
8-16-10/11	10 066 0050		Pompa Acqua - <i>Water Pump</i>	Aprilia-Piaggio-Gilera 50 cc	4352035
10-18-4	10 066 0200		Pompa Acqua - <i>Water Pump</i>	Motori Minarelli - Aprilia - Malaguti	-
15-24-5	10 066 0400		Albero Motore - <i>Crankshaft</i>	Piaggio: Ciao - Si - Bravo - Boss	480464
15.6-25.6-7	10 066 0600		Albero Motore - <i>Crankshaft</i>	Peugeot Kymco 50 cc	711824 0109018
17-27-6	10 066 0780		Albero Motore Lato Volano - <i>Flywheel Side</i>	Motori F. Morini Malaguti 50 cc	60118400
17-28-5.5	10 066 0870		Puleggia Fissa - Albero Primario <i>Fixed Pulley - Drive Shaft</i>	Mbk-Yamaha-Malaguti	931021734200 75311700
17-35-8	10 066 1080		Applicazioni Varie - <i>Various</i>	Applicazioni Varie	-
17-35-8	10 066 1090		Albero Motore Lato Volano - <i>Flywheel Side</i>	Fbm	-
18-28-7/7.5	10 066 1400		Albero Motore Lato Volano - <i>Flywheel Side</i>	Aprilia-Piaggio-Gilera 50 cc	482315
18-28-7/7.5	10 066 1420 Viton		Albero Motore Lato Volano - <i>Flywheel Side</i>	Aprilia-Piaggio-Gilera 50 cc	482315
19-30-7	10 066 1600		Albero Motore Lato Frizione - <i>Clutch Side</i>	Aprilia-Piaggio-Gilera 50 cc	482314
19-30-7	10 066 1610 Viton		Albero Motore Lato Frizione - <i>Clutch Side</i>	Aprilia-Piaggio-Gilera 50 cc	482314
19-32-7	10 066 1700		Albero Motore Lato Volano - <i>Flywheel Side</i>	Piaggio Vespa	430390 - 155579
19-32-7	10 066 1710 Blue		Albero Motore Lato Volano - <i>Flywheel Side</i>	Piaggio Vespa	430390 - 155579
19 - 32 - 7	10 066 1712 ROLF		Albero Motore Lato Volano - <i>Flywheel Side</i>	Piaggio Vespa 50-90 Primavera Et3 V5a1-V5b1-V5b2-V5sa1-V9a1-Vma2-Vmb1	155579
20 - 30 - 7	10 066 1850		Albero Motore Lato Frizione - <i>Clutch Side</i>	Peugeot	706450
20 - 30 - 7	10 066 1860 Viton		Albero Motore Lato Volano - <i>Flywheel Side</i>	Piaggio 125 4T: Fly - Liberty - Vespa 150 4T: Liberty-Vespa	82898R
20 -30/33.5-5.3/6	10 066 1900		Albero Motore Lato Volano - <i>Flywheel Side</i>	Motori Minarelli Aprilia-Mbk -Yamaha	AP8206212 931012013800
20-31-7	10 066 1950 Viton		Albero Motore Lato Frizione - <i>Clutch Side</i>	Kymco 50 2T	00109139
20 -32 -7	10 066 2000		Albero Motore Lato Volano - <i>Flywheel Side</i>	Piaggio Ape-Vespa 50	289306
20 - 32 - 7	10 066 2202 ROLF		Albero Motore Lato Volano - <i>Flywheel Side</i>	Piaggio Vespa 50 Pk XL-N-FL Vn5x3T-V5x5-V5N1	289306
20 - 32 - 7	10 066 2010 Viton		Albero Trasmissione - <i>Drive shaft</i>	Piaggio 125 4T: Beverly-Carnaby-Fly-Liberty-Mp3-Typhoon-Vespa	82878R
20 - 40 6	10 066 2370 ROLF		Albero Motore Lato Volano - <i>Flywheel Side</i>	Piaggio Vespa 150 GL-Sprint-Super VLA-VLB-VBC Rally	084644
20 - 40 6	10 066 2102 ROLF		Albero Motore Lato Volano - <i>Flywheel Side</i>	Piaggio Vespa 150 GL-Sprint-Super VLA-VLB-VBC	025180
20-42/43-8/9	10 066 2300		Albero Motore Lato Frizione - <i>Clutch Side</i>	Mot: Minarelli- Aprilia Mbk Yamaha	AP8206213 931022037100
20-62-6,5	10 066 2360		Albero Motore Lato Frizione - <i>Clutch Side</i>	Vespa Sprint - GL 150	048290
20.8-53-6/9	10 066 2380		Albero Motore - <i>Crankshaft</i>	Honda Sh 125-150	-
22-32-7	10 066 2430		Semiassa - <i>Half Shaft</i>	Piaggio Ape Mp-Car	431044
22 - 34 - 6	10 066 2490		Albero Ruota Posteriore - <i>Rear Wheel Shaft</i>	Kymco 250 People Lc 03-04 • People S 06 • X Citing 05-07 • 300: X Citing 08-09	00125780
22-35-6	10 066 2550		Ruota Posteriore - <i>Rear Wheel</i>	Piaggio Ciao I Serie	58752

PARAOLIO - RICERCA PER MISURA
OIL SEALS - SEARCH BY SIZE



MISURE SIZE	CODICE CODE	BARCODE	DESCRIZIONE DESCRIPTION	APPLICAZIONI APPLICATIONS	RIF. ORIGINALE OEM NUMBER
22-45-7	10 066 2650		Applicazioni Varie - <i>Various</i>	Applicazioni Varie	-
22.7-47-7/7.5	10 066 2700		Albero Motore Lato Frizione - <i>Clutch Side</i>	Piaggio Vespa 50-125 Primavera	289305
22.7-47-7/7.5	10 066 2710 Blue		Albero Motore Lato Frizione - <i>Clutch Side</i>	Piaggio Vespa 50-125 Primavera	289305
22,7 - 47-7/7,5	10 066 2702 ROLF		Albero Motore Lato Frizione - <i>Clutch Side</i>	Piaggio Vespa 50-90 Primavera Et3 V5a1-V5b1-V5b2-V5sa1-V9a1-Vma2-Vmb1	008731
24-35-6	10 066 3000		Albero Motore Lato Volano - <i>Flywheel Side</i>	Piaggio Vespa Pk 125 XL-Px	431121
24 - 35 - 6	10 066 3002 ROLF		Albero Motore Lato Volano - <i>Flywheel Side</i>	Piaggio Vespa Px 125-150-200 Super 150 Vbc 1T	158962
24-35-7	10 066 3050		Albero Motore - <i>Crankshaft</i>	Gilera - Piaggio Hexagon Skipper 125	4345826
24.9-45-5.5/6.5	10 066 3400		Albero Motore Lato Volano Esterno <i>Flywheel External</i>	Piaggio Ape Mp-P601 I Serie	078002
24.9-45-5.5/6.5	10 066 3450		Albero Motore Lato Volano Esterno <i>Flywheel External</i>	Piaggio Ape Mp-P601 I Serie	078002
25-37-6	10 066 3600		Albero Motore Lato Frizione - <i>Clutch Side</i>	F.Morini Malaguti	60118500
25 - 40 - 8	10 066 4000		Albero Motore Lato Frizione - <i>Clutch Side</i>	Kymco 125 -150 B&w Eu2 • Dink Classic Dink • 500 Xciting I/R 05-09	00121912
27-37-7	10 066 4500		Albero Ruota Posteriore - <i>Rear Wheel Shaft</i>	Piaggio Vespa 50-Et3-Pk-Gl-Sprint	046699
27-42-10	10 066 4700		Ruota Posteriore - <i>Rear Wheel</i>	Piaggio Ape 50	118058
27 - 42 - 10	10 066 4702 ROLF		Ruota Posteriore - <i>Rear Wheel</i>	Piaggio Vespa Px 125-150-200 Cosa 125-T5 125 Vnx5t	118058
27 - 42 - 7	10 066 4550		Ruota Posteriore - <i>Rear Wheel</i>	Kymco 50 Agility 4T R10/R12/R16 Agility 2T R16 • 125 Agility Rs • Agility R16 250-300 People S X Citing	00108209
27-47-6	10 066 4800		Ruota Posteriore - <i>Rear Wheel</i>	Piaggio Vespa Px	130536
27 - 47 - 6	10 066 4802 ROLF		Ruota Posteriore - <i>Rear Wheel</i>	Piaggio Vespa Px 125-150-200 1 Serie-Vespa GL 150 Sprint-Rally	130536
30-47-6	10 066 5500		Albero Ruota Posteriore - <i>Rear Wheel Shaft</i>	Piaggio Vespa Px-Sfera-Zip- Et4 Gilera Runner – Stalker – Typhoon	478498 – 008714
30 - 62 - 6,5	10 066 2362 ROLF		Albero Motore Lato Frizione - <i>Clutch Side</i>	Piaggio 150 GL-Sprint-Super VLA-VLB-VBC	049290
31-62-4.3/5.8	10 066 6000		Albero Motore Lato Frizione - <i>Clutch Side</i>	Piaggio Vespa Arcobaleno – Px	431122 – 131102
31-62-4.3/5.8	10 066 6010		Albero Motore Lato Frizione Struttura metallo - <i>Clutch Side Metal frame</i>	Piaggio Vespa Arcobaleno – Px	242550
31-62-4.3/5.8	10 066 6002 ROLF		Albero Motore Lato Frizione - <i>Clutch Side</i>	Piaggio Vespa Px 125-150-200 1 Serie Vnx-VLX-Vbx-Vespa 150 GL-Sprint-Super VLA-VLB-Vbc	131102
40-47-4	10 066 8500		Puleggia Frizione posteriore mobile - <i>Pulley</i>	Piaggio : Sfera-Zip	478269



PACCHI LAMELLARI

REED VALVES

10 056 0010



APRILIA: Amico 50 cilindro verticale
Amico 50 engines with vertical cylinder
MBK: Booster Road • NG • Spirit • Track
 Rocket • Booster 90-00
YAMAHA: 50 Spy • Bw's Bump original
 • NG Kat 95-00
 (R.O. 3VLE361000)



10 056 0020



Per Motori Minarelli orizzontale
For Minarelli Engine horizontal
APRILIA: Scooter 50 (R.O. 8206557)
MALAGUTI: Centro SL • Base • F10 Jet Line
 Yesterday • F12 Phantom Aria LC • F15 Firefox
 (R.O. 76004600)
MBK: New Sorriso
 Flipper • Ovetto • Nitro • Evolis • Fizz • Forte
 (R.O. 4CUE36100000)
YAMAHA 50: Aerox R • Why • Breeze
 Axis • Neo's 94-01
 (R.O. 4CUE36100000)



10 056 0100



GILERA 50: Runner doppio disco
Twin Discs • Dna • Ice • Typhoon 01
PIAGGIO: Nrg • Rst-Mc2 • Vespa Et2
 • Diesis • Zip Sp
 (R.O. 486353)



10 056 0110



GILERA 50: Easy Moving • Stalker • Storm
 • Typhoon 50 - X - Xr
PIAGGIO 50: Free • Free FL • Free Delivery • Nrg
 • Mc3 Extreme • Liberty • Quartz • NTT • Sfera
 Maquillage 2 Et2 • Zip • Zip Fd • Zip Fast Rider • Zip
 Fast Rider Rst • Zip Rst - SP 01 • Skr Ct 80
 (R.O. 435867)



10 056 0130



PEUGEOT 50: Ludix



10 056 0140



PIAGGIO 50: Fly 2T 06-10 • Liberty 2T 06-08
 • Nrg Power Dt 06-11 • Nrg Power Purejet 06-
 11 • Typhoon 2T Eu2 10-11 • Typhoon 05-09
 • Vespa Lx 2T - Touring 05-11 • Vespa Lxv 2T
 06-08 • Zip 2T 08-10
 (R.O. 82774R)





12 062 0070 

PIAGGIO 150: Vespa GL • Px
125: Vespa Px
(R.O. 179803-227205)



12 062 0080 

PIAGGIO 125-150-200: Vespa Px 1° Serie
Vnx-Vlx-Vbx
(R.O. 181476)



10 062 0030 

PIAGGIO: Ape Car Mp
(R.O. 133404)



10 062 0060 

PIAGGIO 50-125: Vespa 5Et3
(R.O. 71813)



10 062 0050 

PIAGGIO 50: Vespa Pk Pk XL • Rush N • FL
(R.O.178694)



12 062 0090 

PIAGGIO 150: Vespa Sprint • GL
180: Vespa Rally
(R.O. 093766)



10 062 0041 

GILERA 50: Ice 01 • Easy Moving 95-96 •
Runner 97-00 • Stalker 97-01 • Storm 94-95
Typhoon 94-97 • X 98-99 • Xr 00
125: Typhoon 95-98 • X-Xr 99-00
125-180: Runner Fx • Fxr 97-02 (Mikuni)
PIAGGIO 50: Diesis 01 • Free 92-94 • FL 95-00
• Delivery 00-01 • Ntt 95-96 • Nrg 94-96
• Rst Mc2 96-98 • Extreme 99-00 • Nrg Mc3 01-02
• Sfera base 91-93 • Maquillage 2 94 • Rst 95-97
• Typhoon 01 • Vespa Et2 97-01 • Zip base 92-96
• Rst 96-99 • Fast Rider Rst 96-97 • Zip fast Rider
93-94 • Sp 96-00
80: Skr city 99
125-150: Hexagon 94-97 • Skipper 94-97 • Lx 98-99
(R.O. 436096)



12 062 0100 

PIAGGIO 160-180: Vespa Gs
(R.O.077628)





COLLETTORI ASPIRAZIONE

INLET PIPES

10 052 0010 

APRILIA 50: Amico
MBK 50: Booster 90-01 • Road • Spirit • NG
• Rocket Track
YAMAHA 50: Spy • Bw's Bump original
• NG • Kat • Slider 95-01
(R.O. 3VLE35550000)



10 052 0020 

APRILIA: Scooter 50 motori con cilindro orizzontale - *Engine with horizontal cylinder*
(R.O. 8206466)
MALAGUTI: Centro • SL Base • F10 Jet Line
• F12 Phantom LC Aria • F15 Firefox • Yesterday
(R.O. 76004500)
MBK: Ovetto • Evolis • Fizz • Forte • Nitro
Flipper • Kat 94-01
YAMAHA 50: Aerox • R • Why Kat • Breeze
Axis • Neo's 94-01
(R.O. 4CUE35550000)



10 052 0030 

GILERA 125: Runner Fx-Fxr 97-02
Typhoon 95-98 • X - XR 99-00
180: Runner Fx - Fxr 97-02
PIAGGIO 125: Hexagon 94-97
Hexagon Lx - Lxt 98-99 • Skipper 94-97
• Lx 98-99
150: Hexagon 94-97 • Skipper 94-97 • LX 98-99
(R.O. 430206)



10 052 0040 

PIAGGIO 125: Liberty 98-00 • Vespa Et4 96-99
• Sfera 95-97
(R.O. 480799)



10 052 0050 

PIAGGIO 125-150: Liberty 00-02
• Skipper 4T 00-02 • Vespa ET4 99-02
• Zip 125 00-02
(R.O. 485587)



10 052 0100 

GILERA 50: Easy Moving • Runner • Ice • Stalker
• Storm • Typhoon • X • Xr • Dna
PIAGGIO 50: Free • Delivery • Nrg Rst • Mc2
Mc3 • Extreme • Diesis-Liberty
NTT • Sfera Rst 50 • Sfera Maquillage 2
• Et2 • Zip • Zip 95 • Zip Fast Rider
Zip Sp • Zip Rst
Zip Fast Rider Rst
Zip FD (disc brake)
80: Skr City
(R.O. 436095)



10 052 0260 

PEUGEOT 50: Ludix



10 052 0340 

MOTORI MINARELLI AM6
MINARELLI ENGINE AM6
YAMAHA 50: Dt R - Dt X 06-08 • Tzr 03-08 • Tzr
Rr 05 • Dt R - Dt Rsm 03-05
(R.O. 4YVE35653000)



10 052 0240 

SUPPORTO ELASTICO CARBURATORE
INLET HOLDER CARBURETOR
PIAGGIO: Ape - Car P2-P3 - Mp • P 501 • P 601 •
TM • P602 • P703 • P703V • FL2
(R.O. 566859)



10 052 0390 

KYMCO 50: Agility 4T R16 08-12 • Super 8 07-13
(R.O. 00117075)



10 052 0350 

KYMCO 50: Dink 4T 07
(R.O. 00102054)



10 052 0360 

KYMCO 50: Agility 4T R10 06-08
(R.O. 00102048)



10 052 0370

KYMCO 125: Agility 4T 06 • Movie 03-07
Agility R16 08-12 • Agility 4T 06-08 • Agility Carry
11 • Agility Rs 09 • Like 09 • Like Lx 12
150: Movie 03-07 • Agility R16 08-09
(R.O. 00122198-00117091-00122116)

10 052 0400

KYMCO 300: Downtown I 09 • Downtown Abs
10 • People Gti 10
(R.O. 00117182 - 1711A-LEA7-E00)

10 052 0410

KYMCO 400: X-Citing I 13-15 • X-Citing I Abs 14-15
(R.O. 00117491 - 1711A-LKF5-E00)

10 052 0420

KYMCO 125: Downtown I 09 • K-Xct I 12-14
• People Gti 10
(R.O. 0117198 - 1711A-LFA7-E00)

10 052 0430

KYMCO 300: Downtown Abs I 11 • Downtown I
11 • K-Xct I Abs 14 • K-Xct I 12 • People Gti Abs 12-
14 • People Gti 11-14 • Downtown I Abs 15
(R.O. 00117345 - 1711ALEA7E05)





COLLETTORI ASPIRAZIONE - SCARICO

INLET - EXHAUST PIPES

10 052 0130



PIAGGIO: Vespa 125 Primavera
per carburatore 19/19 • 19/19 carburator
(R.O.112869)



10 052 0150



PIAGGIO: Vespa 50
per carburatore 16/10 • 16/10 carburator
(R.O. 079802)



10 052 0160



PIAGGIO: Vespa 90
per carburatore 16/16 • 16/16 carburator
(R.O. 078542)



10 052 0170



PIAGGIO: Vespa 50 Pk XL
per carburatore 16/10 • 16/10 carburator
(R.O. 480831)



10 052 0200



PIAGGIO: Vespa 125 Pk XL
FL-3 fori per carburatore 19/19
3 holes carburator 19/19
(R.O. 224755)



10 052 0220



PIAGGIO 50: Ape FL-FL2 89-95 • Ape FL3 Euro-
pa 96-99 • Ape Mix 2T 98-08 • Ape P 80-85 • Ape
Rst Mix 99-03 • Ape Tm P 85-89 • Ape 09-16
(R.O. 266889)



COLLETTORI SCARICO IN ALLUMINIO PRESSOFUSO EXHAUST ALLOY CAST PIPES

10 052 0230



PIAGGIO 50: Ape
(R.O. 127183)



10 054 0010



PIAGGIO 50-90: Vespa
125: Vespa Primavera Et3
(R.O. 247033)



10 054 0020



PIAGGIO 125: Vespa Pk
(R.O. 222208)



▶ FILTRI ARIA

AIR FILTERS





FILTRI ARIA RACING
RACING AIR FILTERS

10 060 1000

Ø 32
Per carburatore - *For carburator*
PHBG

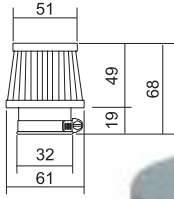

10 060 1010

Ø 35
Per carburatore - *For carburator*
PHVA-PHBN-PHBD-PHBE

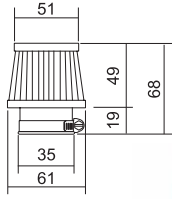

10 060 1020

Ø 38
Per carburatore - *For carburator*
PHBL

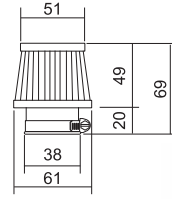

10 060 1030

Ø 35
Per carburatore - *For carburator*
PHBG-PHVA-PHBN-PHBD-PHBE

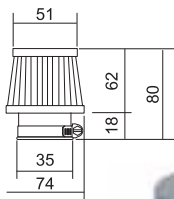

10 060 1040

Ø 38
Per carburatore - *For carburator*
PHBL

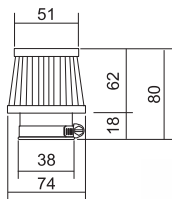

10 060 1050

Ø 32
Per carburatore - *For carburator*
PHBG

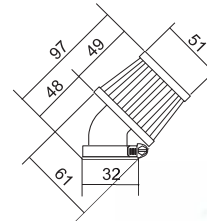

10 060 1060

Ø 35
Per carburatore - *For carburator*
PHBL

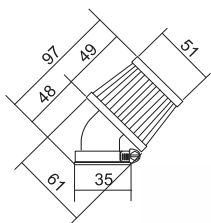

10 060 1070

Ø 35

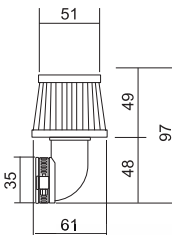

10 060 1120

Ø 35

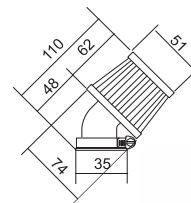



10 060 1080

Ø 32

Con cuffia protezione in plastica
 anti acqua-fango-polvere
Dust water mud protection cover

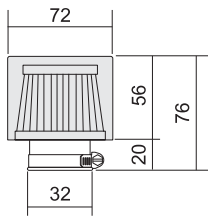

10 060 1090

Ø 35

Con cuffia protezione in plastica
 anti acqua-fango-polvere
Dust water mud protection cover

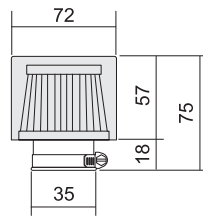

10 060 1100

Ø 38

Con cuffia protezione in plastica
 anti acqua-fango-polvere
Dust water mud protection cover

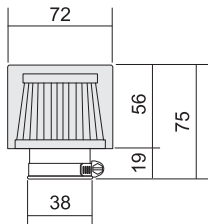

10 060 1110

Ø 35

Con cuffia protezione in plastica
 anti acqua-fango-polvere
Dust water mud protection cover

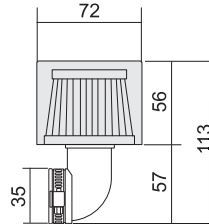



FILTRI ARIA
AIR FILTERS

APRILIA

10 060 0010 

50: Amico GL • GLe 96-98 • Amico Lx • Sport-Cat 92-93 • Sr 93
(R.O. AP8201378)



10 060 0020 

50: Scarabeo 93-05
(R.O. AP8201583)



10 060 0030 

50: Area 51 98-00 • Gulliver Lc 96-98 • Rally-Lc 95-03 • Sonic-Gp 98-08 • Sr • Sr Lc 94-96 • Sr Stealth Racing 97-99 • Sr Www 97-01
(R.O. AP8201683)



10 060 0040 

125-150: Leonardo 96-01 • Leonardo St 01-04
(R.O. AP8102582)



10 060 0120 

125-150: Sr 99-01
(R.O. AP8102943)



10 060 0650 

125: Scarabeo 03-06 • Scarabeo Eu3 06-07 • Scarabeo Mot Rotax 99-03
150: Scarabeo Mot Rotax 99-03
200: Scarabeo 03 • Scarabeo Eu3 06-07
250: Scarabeo 04-06
(R.O. AP8102832)



10 060 0660 

250: Leonardo 99-04 • Leonardo St 01
300: Leonardo 02-04
(R.O. AP8102860)



10 060 0860 

125: Mojito Retro' • Custom 99-01
(R.O. AP8102965)



10 060 0950 

50: Mojito Custom 99-03 • Mojito Retro 99-03
(R.O. AP8202138)



10 060 0990 

125: Atlantic 03-05 • Atlantic Eu3 06-08 • Sport City 04-06 • Sport City Cube 08
Sport City Eu3 06-08
200: Atlantic 03-05 • Sport City 04-06 • Sport City Cube 08 • Sport City Eu3 06-08 • Atlantic 03-05
250: Atlantic Eu3 06-08 • Scarabeo Light 06-08 • Sport City Eu3 06-08 • Sport City Cube 06-08
300: Scarabeo Light 09 • Sport City Cube 08
400: Atlantic Sprint 05-08 • Scarabeo Light 06-08
500: Atlantic Sprint 05-08
Scarabeo Light 06-08
(R.O. 829258)



10 060 1150 

500: Atlantic 01-04 • Scarabeo 03-06
(R.O. AP8104242)





APRILIA

10 060 1180 

FILTRO ARIA SECONDARIO
SECONDARY AIR FILTER

50: Scarabeo 4T 4V Net 09-12 • Scarabeo 4T Restyling Eu3 06-09 • Scarabeo Quattro 09
100: Scarabeo 4T Net Eu3 10 • Scarabeo 4T Net 10 • Scarabeo 4T Restyling 06-09 • Scarabeo 4T 10-12 (R.O. AP8570092-832972)



10 060 1300 

50: Sr Ditech Eu2 02-03 • Sr H2O Ditech E Carb 00-03 • Sr R R Factory 04-09 • Sr Street 03-08 (R.O. AP8202302)



10 060 1310 

50: Sr R Factory Motore Aprilia 05 • Sr R R Factory 04-09 (R.O. AP8202443)



10 060 2090 

50: Scarabeo Ditech 01-04 (R.O. AP8202262)



10 060 2100 

FILTRO ARIA ASPIRAZIONE - INDUCTION

50: Scarabeo 4T 02-06 • Scarabeo 4T Rst Eu3 06-09 • Scarabeo Quattro 09
100: Scarabeo 4T 01-04 • Scarabeo 4T Rst 06-09 (R.O. AP8202249)



10 060 2230 

650: Pegaso 3 97-00 • Pegaso Le 01-04 (R.O. AP8102715)



10 060 2470 

125-200: Scarabeo Light 07-09 (R.O. JC13721X92000)



10 060 2560 

FILTRO ARIA CINGHIA - BELT

125-200 : Scarabeo Mot. Piaggio 04/07 • Atlantic 03-10 • Sport City 04-08 • Sport City One 08-10 • Sport City Cube 08-10
250: Scarabeo Lite 06-10 • Atlantic 03-10 • Sport City 04-08 • Sport City Cube 08-10
300: Scarabeo Lite 06-10 • Atlantic 06-10 (R.O. 842093)



ATALA

10 060 0050 

50: At 10 • Byte • Hacker • Skeggia



10 060 0680 

50: Lepton





FILTRI ARIA
AIR FILTERS

BENELLI - BETA

10 060 0060



50: 491 Gt 98-99 • 491 Rr 98-01 • 491 Sp 99
• 491 Sport 98-99 • 491 St • K2 98-01
• K2 Liquid Cooled 99-01 • Naked 02
100: K2 99-01
(R.O. R72340011A0)
BETA 50: Ark Air 96-08 • Ark Lc 96-03 • Ark
Lc Serie K 04-08 • Elkon 99-03
(R.O. 3KJ144510000)



10 060 0330



250: Velvet 99-01 • Velvet Touring 02-03
(R.O. R72317001AZ)



10 060 0420



125-150: Adiva 01-02
(R.O. R72340061AO)



BMW

10 060 2220



650: F-Cat 93-99 • F-St 93-99



10 060 2250



450: R 45 78-80
500: R 50/5 69-73
600: R 60/5/6/7 69-80
650-750-800: R65 •
R75/5/6/7 • R80/7 69-80
900-1000: R 90/5/6 •
R100 Rs-R100/7 73-80



CAGIVA

10 060 0970



50: Cucciolo 98-99 • Progress 97-99
Progress Lc 98-99
(R.O. 00G03202251)



CASALINI

10 060 2320



MICROCAR CASALINI





DERBI

10 060 0460 

50: Atlantis 4T Eu2 07 • Atlantis 4T 04-06
100: Atlantis 4T 04-06
(R.O. 431587)



10 060 0890 

125-150: Boulevard Eu3 03-07
Boulevard 4T 09
200: Boulevard 05
(R.O. 487401)



10 060 0920 

50: Atlantis 2T Eu2 07-10 • Atlantis 02 •
Bullet-City-Two Chic 03-05 • Boulevard 2T 09
• Gp1 Open Eu2 06-09 • Gp1 01-03
(R.O. 487719)



10 060 0970 

50: Atlantis 99-01 • Atlantis Lc 99-01
Hunter 96-97 • Paddock 98-99
Predator Lc 98-01 • Predator O2 98-01
100: Atlantis 00-01
(R.O. 00G03202251)



10 060 0990 

125: Gp1 Eu2 06 • Gp1 Low Seat Eu3 07-08
• Rambla 08
250: Gp1 06-07 • Gp1 Low Seat Eu3 07-08
Rambla 08
(R.O. 829258)



10 060 1160 

50: Boulevard 4T Eu2 25 Km/H 09
125: Boulevard 4T Eu3 08-09
(R.O. 843194)



10 060 1170 

FILTRO ARIA SECONDARIO
SECONDARY AIR FILTER

125-150: Boulevard Eu3 03-07
Boulevard 4T 09
200: Boulevard 05
(R.O. 832703)



10 060 1180 

FILTRO ARIA SECONDARIO
SECONDARY AIR FILTER

50: Atlantis 4T Eu2 04-07
Boulevard 4T Eu2 25 Km/h 09
100: Atlantis 4T 04-06
(R.O. 832972)



10 060 1190 

FILTRO ARIA SECONDARIO
SECONDARY AIR FILTER

50: Atlantis 2T Eu2 07-10 • Atlantis 02 •
Bullet-City-Two Chic 03-05 • Boulevard 2T 09
• Gp1 Open Eu2 06-09 • Gp1 01-03
(R.O. 487719)



10 060 1220 

FILTRO ARIA SECONDARIO
SECONDARY AIR FILTER

250: Gp1 06-07
(R.O. 840476)



10 060 2560 

FILTRO ARIA CINGHIA - BELT

125: Boulevard Eu3 04-07
Boulevard 03-04 • Gp1 Eu2 06 • Rambla 06-08
150: Boulevard Eu3 04-07 • Boulevard 03-04
250: Gp1 06-07 • Rambla 06-08
300: Rambla 10
(R.O. 842093)





GILERA

10 060 0080 

125: Typhoon 95-98 • Typhoon X-Xr 99-00
(R.O. 478240)



10 060 0090 

50: Storm 94-95 • Typhoon 94-97 • Typhoon X 98-99 • Typhoon Xr 00
(R.O. 433437)



10 060 0110 

50: Runner 97-00 • Runner Purejet 02-07 • Runner Purejet St 08 • Stalker 97-04
(R.O. 479748)



10 060 0120 

125-180: Runner Fx-Fxr 97-02
(R.O. 480084)



10 060 0430 

50: Easy Moving 95-96
(R.O. 834741)



10 060 0880 

125-180: Dna 01 • Runner Vx Vxr 00-01
(R.O. 827936)



10 060 0920 

50: Dna 00-02 • Dna 05-07 • Dna Gp Experience 03-04 • Ice 01-05 • Runner Poggiali 02 • Runner Sp 02-12 • Runner Sp Spec Edit 07 • Runner Sp St & Simoncelli 08-09 • Stalker 05-11 • Stalker Naked 08 • Stalker Spec Edit 07-08 • Storm Eu2 07
(R.O. 487719)



10 060 0990 

125: Nexus Eu3 07-08 • Nexus Eu3 Ie 08-10 • Runner Vx 05-06 • Runner Vx 4T Eu3 07 • Runner Vx 4T St Eu3 08-13 • Runner Vx Race 06 • Runner Vx Sc 06-07 • Runner Vx-Vxr 02-04
200: Runner Vx-Vxr 02-06 • Runner Vxr 4T St Eu3 08-11 w • Runner Vxr Eu3 07 • Runner Vxr Race 06
250: Nexus Eu3 06-07 • Nexus Sp Eu3 06-07
300: Nexus Eu3 09-11
500: Fuoco 07-09 • Fuoco Eu3 07-13 • Fuoco 4T-4V Ie E3 Lt 13
(R.O. 829258)



10 060 1140 

500: Nexus 03-05 • Nexus Eu3 09-11 • Nexus Sp Eu3 06-07
(R.O. 487845)



10 060 1190 

FILTRO ARIA SECONDARIO
SECONDARY AIR FILTER

50: Dna 00-02 • Dna 05-07 • Dna Gp Experience 03-04 • Ice 01-05 • Runner Poggiali 02 • Runner Sp 02-12 • Runner Sp 10 • Runner Sp Spec Edit 07 • Runner Sp St & Simoncelli 08-09 • Stalker 97-11 • Stalker Naked 08 • Stalker Spec Edit 07-08 • Storm Eu2 07
(R.O. 486942)



10 060 2560 

FILTRO ARIA CINGHIA - BELT

125: Nexus Eu3 07-08
250: Nexus Eu3 Sp 06-07
300: Nexus Eu3 09-11
(R.O. 842093)





GUZZI

10 060 2240 

350: V35 Tutti i modelli - *All models*
500-750-850: V50-Polizia-II-III Custom Monza
• S3-T3 • T3-California T4
1000: Cx100V10-V • Convert-G5-Sp
(R.O. GU17113651)

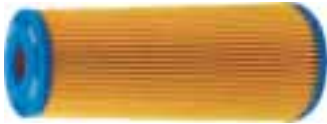

10 060 2280 

1000: California (28113660) • California
94-Classic-Le Mans- Le Mans C.I.-Le Mans
N-California III IE (28113660)-Le Mans IIII-Srl-Sc-
Sp III
(R.O. GU28113660)



10 060 2300 

1000: Daytona ie • Quota • V10
1100: California • Special • Quota • V11 Tutti i
modelli - *All models*
(R.O. GU30113600)



HONDA

10 060 0140 

50: Sh 91-95
(R.O. 17205GJ4760)



10 060 0170 

50: Sj Bali 93
100: Sj Bali 96-99
(R.O. 17205GAV700)



10 060 0200 

50: Sh 96
100: Sh 96-99
(R.O. 17205GBY910)



10 060 0210 

50: Sky 97
(R.O. 17205GBM750)



10 060 0220 

50-90: Shadow



10 060 0230 

50: Sfx V 95
(R.O. 17205GBM750)



10 060 0780 

250: Foresight 98
(R.O. 17210KFG010)



10 060 0810 

125: Pantheon 2T 98-02
150: Pantheon 2T 98-02
(R.O. 17205KEY900)



10 060 1131 

125: Chiocciola 00-06 • Dylan 01-06 • Ps I
06-08 • Sh 125 01-08 • Sh 125 i 01-08
150: Chiocciola 00-06 • Dylan 01-06 • Ps i
06-08 • Sh 150 01-08 • Sh 150 i 01-08
(R.O. 17210KGF900)





FILTRI ARIA
AIR FILTERS

HONDA

10 060 2380



300: Sh i 07-13
(R.O. 17210KTW900)



10 060 2630



400: Silver Wing 06-08 • Abs 09-10
600: Silver Wing Abs 09-10
(R.O. 17230-MCT-00)



10 060 2640



250: Forza 05-07
(R.O. 17210-KSV-J02)



10 060 2650



125-150 4T: Pantheon 03-07
Silver Wing 07-12
(R.O. 17210-KRJ-900)

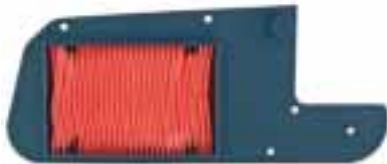

10 060 2660



125: Pcx 11
(R.O. 17210-KWN-900)



10 060 2770



125-150: Pcx 12>
(R.O. 17210-KZR-600)



10 060 2840



50: Vision 11-13
110: Vision 11-13
(R.O. 17210-KZL-930)



10 060 2850



125: Sh 13>
150: Sh 13>
(R.O. 17210-K01-900)



10 060 2900



700: Integra 12-13
750: Integra 14
(R.O. 17210-MGS-D30)



10 060 2910



250: Forza
(R.O. 17210-KVZ-630)





ITALJET

10 060 0120 

125-180: Dragster 99-03



10 060 0240 

50: Formula Lc 97
125: Formula
(2 Pz/2 Pcs)



10 060 0420 

125: Torpedo 98-00 • Torpedo (Mot Leader) 00-03
150: Torpedo (Mot Leader) 00-03
(R.O. 210436478)



KYMCO

10 060 0790 

125-150: Millennium



10 060 0260 

50: Heroism 95-97 • Sniper 93
• Sniper Dd 94-96
(R.O. 00166204)



10 060 0270 

50: Cx 93 • Cx Super 94-97 • Dj W 94-00 • Dj X 91-92 • Djy 93
(R.O. 00163101+00163013)
(2 Pz/2 Pcs)



10 060 0280 

50: Fever Zx 99-00 • Fever Zx Eu2 03-04 • K12 95-00 • Kb 95-00
(R.O. 00163892)



10 060 0520 

50: Heroism 95-97 • Sniper DD 94-96
• Sniper 93
(R.O. 00166204-17205KEB7000)



10 060 0730 

125-150: Dink Classic 02 • Dink Classic Eu2 03 • Dink Lx 98-00
200: Dink Classic 04
(R.O. 00162993)



10 060 0740 

125: Dink Classic 02 • Dink Eu3 06-07
• Grand Dink Eu2 03-04
150: Grand Dink Eu2 01-04
200: Dink Eu3i 06-07
250: Grand Dink 01-04 • X Citing 05-07
300: X Citing i 08 • X Citing i R 08-09
(R.O. 00162475)



10 060 0750 

125: Dink 97-98
150: Dink Classic 02
(R.O. 00162953)



10 060 1320 

50: B&w 02 • B&w Eu2 03 • Dink Classic Eu2 03 • Dink Lc 98-02 • Super 9 00 • Super 9 Sport Eu2 03-04 • Top Boy 97-00 • Vitality 2T 04 • Yup 02 • Yup Eu2 03
(R.O. 00163571-17205KEB7-900)





KYMCO

10 060 1330 

50: People 99-00 • People 04 • People Eu2 03 • People Eu2 08 • People S 05-08 • Super 8 2T 09-13
(R.O. 00162309 - 17205-KFA6-900)



10 060 2310 

125: Agility Plus 14 • Agility R16 09-12 • People 99-00 • People Eu2 03 • People Eu3 07-11 • People S 05 • People S Dd Eu3 07-08 • People One I 13 • Super 8 09
150: Agility R16 08-09 • People 99-00 • People 0 Eu2 03
200: Agility 2001 R16 10 • Agility I Plus 14 • Agility R16 12 • People S 05 • People S I 07
(R.O. 00162377)



10 060 2390 

50: Agility 4T R12 07-08 • Agility R12 05 • Agility Rs 09 • Agility 4T Carry 11 • Vitality 4T 04
(R.O. 00164044)



10 060 2400 

50: Agility 4T R10 06-08
(R.O. 00163126)



10 060 2430 

250: People Lc 03-04 • People S 06 • People S i 07
300: People S 300 I 08
(R.O. 00162380/1721A-LLJ3-E00)



10 060 2450 

50: Agility 4T R16 08-12 • Dink 50 4T 07 • People S 4T 06-08 • Sento 08 • Super 8 07 • Super 8 4T 09-13
(R.O. 00101074)



10 060 2580 

125: Downtown i 09
200: Downtown i 10
(R.O. 00117199-17211LFA7E00)



10 060 2590 

300: Downtown i 09 • Downtown Abs i 10-11 • Downtown i 11
(R.O. 00117245-17211LEA7E00)



10 060 2670 

125-200-300: People Gti 10-14
300: People Gti Abs 12-14
(R.O. 17211-LGE5-E00 • 00117303)



10 060 2700 

50: Like 4T
(R.O. 00117213)



10 060 2760 

125-300: G-Dink 12
(R.O. 00117409)



10 060 2800 

125: Like 09 • Like Lx 12
200: Like 09 • Like Lx 12
(R.O. 00117221)





KYMCO

10 060 2830 

125-300: K-Xct I 12
(R.O. 00117469)



10 060 2920 

500: X Citing R 09 • X Citing I R 07-08 • X Citing I 06-08 • X Citing 05
(R.O. 00163096)



10 060 2980 

400: X Citing i Abs 14-15 • X Citing i 13-15
(R.O. 00117492)



NEW

LML

10 060 9340 

125: Movie 125 Eu3 06-07 • Movie XL 01 • Movie XL Eu2 03-04
150: Movie Eu3 06-07 • Movie XL 01 • Movie XL Eu2 03-04
(R.O. 00163996)



10 060 2960 

125-150: Star Automatica



10 060 2180 

FILTRO ARIA VARIATORE - CVT AIR FILTER
125-150: Star Automatica



MALAGUTI

10 060 0060 

50: Centro Base 93-94 • Centro SL 94-98 • Centro SL Kat 99-00 • F10 Ac 08 • F10 Ac Eco 09 • F10 Jet Line 92-98 • F10 Kat 99-00 • F10 Rst Eu2 06 • F10 Rst Eu2 02-03 • F10 Rst Eu2-2.3 03-04 • F12 Ac/Lc Rst Eu2 06 • F12 Phantom Eu1 Lc 94-00 • F12 Phantom Lc Rst Eu1 01-02 • F12 Phantom Lc Rst Eu2 02 • F12 Phantom Lc T. D. 98 • F12 Phantom Rst Eu1 Eu2 01-02 • F12 R Phantom Ac/Lc 07-09 • F15 Fire Fox Ac 05-06 • F15 Fire Fox Eu2 02-03 • F15 Fire Fox Rst Eu2-2.3 03-04 • F15 Lc Rst Eu2 04-05 • Yesterday • Euro 97-00
(R.O. 06604500)



10 060 0290 

50: Crosser Cr1 95-98
(R.O. 06605500)



10 060 0300 

50: F15 Fire Fox 96-98 • F15 Fire Fox Twin Disks & Spec 98-99 • F15 Fire Fox Twin Disks Digit Kat 98-00 • F15 Lc-Tds Rst Eu1 01
(R.O. 06606600)



10 060 0330 

250: Madison S 99-01
(R.O. 06608100)



10 060 0790 

125: Madison 99-01 • Madison R Rst 02 • Madison R Rst Eu2 03-04 • Phantom Max 03
150: Madison T 99-01
(R.O. 06612400)





FILTRI ARIA
AIR FILTERS

MALAGUTI

10 060 0820 

100: Ciak 99-00 • F12 Phantom 99-00
(R.O. 06608800)



10 060 0830 

50: Ciak 99-00 • Ciak Master 04 • Ciak Master
Eu2 06 • Ciak Mono Eu2 03 • Ciak Mono Eu2
2.3 03 • Ciak Td 00-01
(R.O. 06609100)



10 060 0990 

125: Madison 3 06-09
200: Madison S Rst 02 • Madison S Rst Eu2
03 • Phantom Max 03
250: Madison 3 06-09 • Madison Rs Rst 04
Phantom Max 04
(R.O. 06614100)



10 060 1140 

500: Spidermax Gt 04-05-Spidermax Gt Eu3
06 • Spidermax Rs 08
(R.O. 06615400)



10 060 1200 

125-150: F18 Warrior 00-02
(R.O. 06610300)



10 060 1210 

250: Password 05-06 • Password Eu3 07-08
(R.O. 06626100)



10 060 2000 

FILTRO ARIA VARIATORE
VARIATOR AIR FILTER

250: Madison S 99-01
(R.O. 06607900)

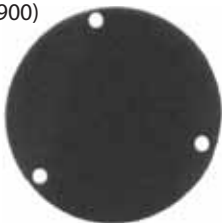

10 060 2020 

400: Madison K 02
Madison K Rst 02-04
(R.O. 06611700)



10 060 2310 

125: Ciak 00-01 • Ciak Master 04 • Ciak Master
Eu3 06 • Ciak Rst Eu2 03
150: Ciak 00-02 • Ciak Master 04 • Ciak Rst Eu2 03
200: Ciak Master Eu2 06
(R.O. 06611003)



10 060 2500 

125-160: Blog ie 09 • Centro ie 08-09
Centro SL i e 09
(R.O. 65046700)



10 060 2510 

FILTRO ARIA VARIATORE
VARIATOR AIR FILTER

125-160: Blog ie 09 • Centro ie 08-09
Centro SL i e 09
(R.O. 65041100)



MICROCAR

10 060 2320 

LIGIER





MBK

10 060 0060 

50: Evolis 92-95 • Fizz 94-95
(R.O. 3KJ144510000)



10 060 0310 

50: Booster 01-04 • Booster 90-94 • Booster Naked
03 • Booster Spirit 96-00 • Booster Spirit Eu2 02-03
• Cw L Booster 01-03 • Cw L Booster Spirit 03 • Cw R
Booster Road (Ita) 94-95 • Cw Rs Booster Ng 95-03
• Cw Rs Booster Ng Eu1 99-00 • Cw Rsp Booster
Rocket 97-98 • Cw Rxs Booster Track 96-98 • Cw Sp
Booster Spirit Eu2 02 • Stunt 00-02
(R.O. 3VLE44510100)



10 060 0330 

250: Skyliner 00-03 • Skyliner Abs 03
(R.O. 4HC144510000)



10 060 0350 

50: Flipper 98 • Flipper 01-02 • Flipper Cat.
99-00 • Flipper Eu2 03-04
(R.O. 5EUE44510000)



10 060 0790 

125: Skyliner 03 • Skyliner 98-02
• Thunder 01-02
150: Skyliner 00-02 • Thunder 01-02
180: Skyliner 03
(R.O. 5DSE44510000)



10 060 0800 

125: Flame R 96-99
(R.O. 4CWE44510200)



10 060 0850 

300: Kilibre 03
(R.O. 5SEE44510000)



10 060 0870 

FILTRO ARIA VARIATORE
VARIATOR AIR FILTER
50: Doodo 00-01 • Kyliner 03 • Skyliner 98-02
• Thunder 01-02
150: Doodo 01-02 • Skyliner 00-02
• Thunder 01-02
180: Skyliner 03
(R.O. 5D5154070100)



10 060 2010 

FILTRO ARIA VARIATORE
VARIATOR AIR FILTER
125: Flame 95-99 • Flame F 00
(R.O. 4CWE54071000)



10 060 2420 

FILTRO ARIA VARIATORE
VARIATOR AIR FILTER
250: Skyliner 00-03 • Skyliner Abs 03
300: Kilibre 03
(R.O. 5GM154070000)

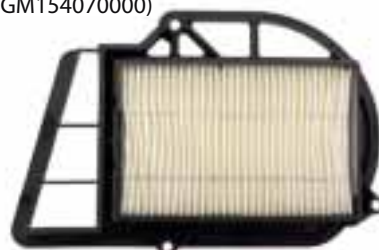



PEUGEOT

10 060 0130 

50: Metropolis Lm-Sxlm 91
(R.O. 705260)



10 060 0360 

50: Sv Geo 91-95
100: Sv L 98
(R.O. 724064)



10 060 0380 

50: St Rapido 85-93
(R.O. 751537)



10 060 0390 

50: Fox 94-98
(R.O. 727905)



10 060 0370 

50: Buxy 94-97 • Elyseo 99 • Elystar Tsd1 03-05 • Looxor 01-03
• Looxor Tsd1 02 • Metal-X 02 • Speedake 95-97 • Speedfight
2 Ac 05-06 • Speedfight 2 Lc-Silversport 05-06 • Speedfight
Lc 97-98 • Speedfight Ac 97-98 • Speedfight Ac Catalitico 99
• Squab 95-97 • Trekker 98-00 • Trk2 Wrc 04-06 • Vivacity 99 •
Vivacity 99-02 • Vivacity Vsx-Xr 02-04 • X-Fight 00 • Xrace 03
• Zenith L 94-96 • Zenith Ln-Ls 97-98 • Zenith N 97-98
(R.O. 730199)



10 060 0510 

50: Xr7 08



10 060 0520 

50: V-Click 4T 08



10 060 0530 

125: Geopolis 07



10 060 0690 

125: Elyseo 125-150 01 • Elyseo 99-00
• Elystar 02-03
150: Elyseo 01 • Elystar 02-03
(R.O. 737534)



10 060 0700 

100: Elyseo 99-01 • Looxor 01 • Speedfight
97-00 • Trekker 98 • Vivacity 99-01
• X-Fight 00-01
(R.O. 737351)



10 060 0780 

250: Sv 01-02
(R.O. 754906)





PEUGEOT

10 060 0930 

125-150: Looxor 02-03
(R.O. 747486)



10 060 0990 

250: Geo Rs 08-09 • Satelis • Sat Rs 08-09
400: Geopolis 07-09 • Geo Rs 08-09 • Satelis
07-09 • Sat Rs 08-09
500: Geopolis 07-09 • Satelis 07-09
(R.O. 759939)



10 060 2480 

50: Vivacity 2t Eu 2
(R.O. 730199)



10 060 2110 

250: Satelis



10 060 2680 

125-150: Tweet 10-12 • Tweet Rs 4T 10-12
(R.O. 801932)



PIAGGIO

10 060 0080 

80: Skr City 99
125-150: Skipper 94-97
(R.O. 478240)



10 060 0090 

50: Nrg 94-96 • Nrg Rst Mc2 96-98
• Ntt 95-96
(R.O. 433437)



10 060 0110 

50: Nrg Extreme 99-00 • Nrg Mc3 01-04 • Nrg
Power Purejet 04-08 • Nrg Purejet 02-04 •
Nrg Rst Mc2 96-98
(R.O. 479748)



10 060 0120 

125: Skipper Lx 98-99
150: Skipper 94-97
(R.O. 480084)



10 060 0400 

50: Liberty 97-05
(R.O. 482738)



10 060 0410 

50: Sfera 91-93 • Sfera Maquillage 2 94
(R.O. 257369)





PIAGGIO

10 060 0420 

50: Vespa Et2 97-05 • Vespa Et2 i 97-00
125: Hexagon Lx4 98-99 • Liberty 98-00
• Sfera 95-97 • Vespa Et4 96-98
(R.O. 436478)



10 060 0430 

50: Zip 4T 00-08 • Zip 92-93 • Zip 95-96
• Zip Fast Raider 93-94
100: Zip 4T 06-08
(R.O. 431838)



10 060 0440 

50: Sfera Rst 95-97 • Vespa Et2 97-05
• Vespa Et2 i 97-00
125: Hexagon Lx4 98-99 • Liberty 98-00
• Sfera 95-97 • Vespa Et4 96-98
(R.O. 478536)



10 060 0450 

10 060 3030 

125: Fly 4T 3V ie E3 Dt 13-15 • Fly 4T 3V ie Eu3
Lem 12-13 • Liberty 4T 3V ie E3 13-14
150: Liberty 4T 3V Lem 13-14
(R.O. B017901)



10 060 0460 

50: Free 92-94 • Free Delivery 00-01
• Free FL 95-02
100: Free 02-03
(R.O. 431587)



10 060 0470 

125: Hexagon 94-97 • Hexagon Lx-Lxt 98-99
150: Hexagon 94-97
180: Hexagon Lx-Lxt 98-99
(R.O. 434364+434363)
(2 Pz/2 Pcs)



10 060 0480 

50: Quartz 92-96
(R.O. 431780)



10 060 0500 

125-150-200: Cosa 2 91-97 • Cosa CL-CLX 88-91
(R.O. 252971)



10 060 0780 

250: X9 00-01
(R.O. 496406)



10 060 0880 

125: X9 01-02
180: X9 Amalfi 00-03
(R.O. 827936)



10 060 0890 

50: Vespa Et4 00-05
125-150: Skipper 4T 00-02 • Vespa Et4 99-02
(R.O. 487401)



10 060 0900 

125: Zip 00-02
(R.O. 827694)





PIAGGIO

10 060 0980 

125: Zip 00-02
(R.O. 827634)



10 060 0910 

50: Liberty 4T 00-02 • Liberty 4T 05-08 • Liberty 4T Delivery Tnt 09
• Liberty 4T Rst 04 • Liberty 4T Sport 06-08 • Liberty Moc 4T 09
125: Liberty 01-02 • Liberty 4T 06-07 • Liberty 4T Eu3 07-08 •
Liberty 4T Eu3 Delivery 08 • Liberty 4T Sport Eu3 06-08 • Liberty
Rst 04-05 • Liberty Rst Ptt 05-06 • Liberty Sport 06
150: Liberty 01-02 • Liberty 4T Eu3 08 • Liberty 4T Sport Eu3 08
200: Liberty 06 • Liberty 4T Eu3 07-08 • Liberty 4T Sport Eu3 06-07 •
Liberty Rst 04 • Liberty Sport 06
(R.O. 487287)



10 060 0920 

50: Diesis 01 • Fly 2T 05-07 • Liberty 2T 06-08
• Liberty 2T Rst 04 • Liberty 2T Sport 06-08
• Liberty Moc 2T 09 • Liberty Ptt Eu2 04-05
• Nrg Mc3 Lc 01-04 • Nrg Power Dd 05-09 •
Nrg Power Dd Serie Spece 07-08 • Nrg Power
Dt 06-08 • Nrg Power Dt Serie Spece 07-08 •
Typhoon 01-09 • Vespa Lx 2T 05-08 • Vespa Lx
2T Fl 09 • Vespa Lxv 2T 06-08 • Vespa Lxv 2T
Navy 08 • Vespa S 2T 07-08 • Zip 00-04 • Zip 2T
08-09 • Zip Sp 01-04 • Zip Sp Eu2 06-09
(R.O. 487719)



10 060 0990 

125: Beverly 01-03 • Beverly Eu3 07-08 • Beverly Eu3 Mic 07 • Beverly Eu3 Sport 07-08 •
Beverly Rst 04-07 • Beverly Tourer Eu3 08-09 • Carnaby 07-09 • X7 Eu3 08 • X7 Evo le Eu3
09 • X9 Evolution 03
200: Beverly 01-03 • Carnaby 07-08 • X9 02-03 • X9 Evolution 03
250: Beverly 06-07 • Beverly Cruiser 07-09 • Beverly Eu3 Mic 07 • Beverly le Eu3 06-08
• Beverly Rst 04-05 • Beverly Sport 06-08 • Beverly Tourer Eu3 08-09 • Carnaby 08
• X7 Eu3 08 • X9 Evolution 04
300: Beverly le Tourer 09 • Carnaby Cruiser 09 • X7 Evo le Eu3 09
400: Beverly Eu3 06-07 • Beverly Tourer Eu3 08-09 • Mp3 07-08 • Mp3 Lt 09 • Mp3 Mic
08-09 • X Evo 07-09 • X8 Eu3 06-08
500: Beverly 02-06 • Beverly Cruiser 07-09 • Beverly Eu3 06-08
(R.O. 829258)



10 060 1140 

125-180: Hexagon Gtx 00 • Super Hexagon
Gtx 12" 01-02
500: X9 01-02 • X9 Evolution 03-07
• X9 Evolution Abs 06-07
(R.O. 487845)



10 060 1160 

50: Fly 4T 05-07 • Fly 4T 08 • Fly 4T Mot Chn 06-07 • Vespa Lx 4T 05-08 • Vespa Lx 4T-4V 09 •
Vespa S 4T-4V 08-09
100: Fly 4T 06-08
125: Fly 05-07 • Fly Eu3 07-08 • Liberty Moc 4T 09 • Vespa Lx 05-06 • Vespa Lx 4T Fl 09 • Vespa Lx
Eu3 06-08 • Vespa Lx Eu3 le 09 • Vespa Lxv 4T Eu3 06-09 • Vespa Lxv 4T Navy Eu3 08 • Vespa S 4T
Eu3 07-08 • Vespa S 4T ie 09 • X8 Street Eu2 06-07
150: Fly 05-07 • Fly Eu3 08 • Liberty Moc 4T 09 • Vespa Lx 05-06 • Vespa Lx 4T FL 09 • Vespa Lx
Eu3 06-08 • Vespa Lx Eu3 ie 09 • Vespa S 4T 08-09 • Vespa S 4T ie 09 • X8 Street Eu2 06-08
(R.O. 843194)





FILTRI ARIA
AIR FILTERS

PIAGGIO

10 060 1170



FILTRO ARIA SECONDARIO - SECONDARY AIR FILTER

125: Fly 05-07 • Fly Eu3 07-08 • Liberty 4T 06-07 • Liberty 4T Eu3 07-08
• Liberty 4T Eu3 Delivery 08 • Liberty 4T Sport Eu3 06-08 • Liberty Moc 4T 09-10 • Liberty Rst 04-05 • Liberty Rst Ptt 05-06 • Liberty Sport 06 • Typhoon 4T 2V EU3 10-11 • Vespa Lx 05-06 • Vespa Lx 4T FL 09 • Vespa Lx Eu3 06-08
• Vespa Lxv 4T Eu3 06-09 • Vespa Lxv 4T Navy Eu3 08 • Vespa S 4T Eu3 07-08
• X8 Street Eu2 06-07

150: Fly 05-07 • Fly Eu3 08-10 • Liberty 4T Eu3 08 • Liberty 4T Sport Eu3 08
• Liberty Moc 4T 09-10 • Vespa Lx 05-06 • Vespa Lx 4T FL 09 • Vespa Lx Eu3 06-08 • Vespa S 4T 08-09 • X8 Street Eu2 06-08

200: Liberty 06 • Liberty 4T Eu3 07-08

• Liberty 4T Sport Eu3 06-07
• Liberty Rst 04 • Liberty Sport 06
(R.O. 832703)



10 060 1180



FILTRO ARIA SECONDARIO - SECONDARY AIR FILTER

50: Fly 4T 05-08 • Fly 4T Mot Chn 06-07 • Liberty 4T 05-08 • Liberty 4T Delivery Tnt 09 • Liberty 4T Rst 04 • Liberty 4T Sport 06-08
• Liberty Moc 4T 09 • Vespa Et4 00-05 • Vespa Lx 4T 05-08 • Vespa Lx 4T-4V 09 • Vespa S 4T-4V 08-09 • Zip 4T 00-08

100: Fly 4T 06-08 • Zip 4T 06-08
(R.O. 832972)



10 060 1190



FILTRO ARIA SECONDARIO - SECONDARY AIR FILTER

50: Ape Eu2 03-10 • Diesis 01 • Fly 2T 05-07 • Liberty 97-05 • Liberty 2T 06-08 • Liberty 2T Rst 04
• Liberty 2T Sport 06-08 • Liberty Moc 2T 09 • Liberty Ptt Eu2 04-05 • Nrg Mc3 01-04 • Nrg Power Dd 05-10 • Nrg Power Dd Serie Spece 07-08 • Nrg Power Dt 06-08 • Nrg Power Dt Serie Spece 07-08 • Typhoon 05-09 • Typhoon 2t E2 10-11 • Vespa Et2 97-05 • Vespa Lx 2T 05-08 • Vespa Lx 2T FL 09-10 • Vespa Lxv 2T 06-08 • Vespa Lxv 2T Navy 08 • Vespa Lxv 2T Touring 10-11
Vespa S 2T 07-08 • Zip 00-04 • Zip 2T 08-09 • Zip Sp Eu2 06-09

125: Vespa Px 30 Anni 07-08 • Vespa Px 11

150: Vespa Px 11

220: Ape TM 09-10
(R.O. 486942)



10 060 1220



**FILTRO ARIA SECONDARIO
SECONDARY AIR FILTER**

250: Beverly 06-07 • Beverly Rst 04-05 • X9 Evolution 04 • X9 Evolution 06
(R.O. 840476)



10 060 2110



125: Mp3 07-08 • Mp3 Ibrido 09-10 • Mp3 ie 08-09 • Vespa Granturismo 03-07 • Vespa Granturismo Eu3 06-07 • Vespa Gts 4T ie Super 09 • Vespa Gts Eu3 07-10 • Vespa Gtv 07-08 • Vespa Gtv 4T Navy Eu3 08 • X Evo 07-X8 05-06 • X8 04 • X8 Premium Eu2 06 • X8 Premium Eu3 06-07 • X9 Evolution 05-06
• X9 Evolution Eu3 07 • X8 04

200: Vespa Granturismo 03-07 • X8 05-07 • X8 04

250: Mp3 06-08 • Mp3 Lt 09 • Mp3 Mic 08-09
Vespa Gt 60 Eu3 06-07 • Vespa Gts, Gts Abs 05-10 • Vespa Gtv 06-09 • Vespa Gtv 4T Navy 08 • X9 Evolution 06 • Xevo 07 • Mp3 300 ie Mic

300: 10-11 • Mp3 ie Lt 10 • Mp3 4T 4V ie Lt Ibrido 10
• Vespa Gts Super 08-10 • Vespa Gts Super Sport 10
• Vespa GTV Via Montenapoleone 10
(R.O. 831997)



10 060 2560



FILTRO ARIA CINGHIA - BELT

125: Vespa Gt-Gts-Gtv 06-10
125-150: Sport 05-10 • X8 • Street 05-10 • X7
125-250-300: Beverly • Sport • Cruiser • Tourer 04-10 • Carnaby • Cruiser • Liberty • X7 Evo
250-300: Vespa Gts-Gtv
250: Street Euro 2 • Mp3
(R.O. 842093)





PIAGGIO

10 060 2600 

500: Porter
(R.O: 614945)



10 060 2620 

1300: Porter
(R.O: 1780187Z18000)



10 060 0610 

50: Ape Eu2 03-10 • Ape FL • FL2 89-95
• Ape FL3 Europa 96-99 • Ape P 80-85 • Ape
Rst Mix 99-05 • Ape Tm P 85-89
(R.O. 290569)



10 060 0620 

220: Ape Car P2-P3 78-85 • Ape Mp P501-
P601 78-96 • Ape Tm P602 82-83
• Ape Tm P703-P703V FL2 84-05
(R.O. 248570)



10 060 0630 

420: Ape Car • Max Diesel 86-96
• Ape Poker Diesel 93-97
• Ape Tm P703-P703V Diesel 87-04
(R.O. 230414)

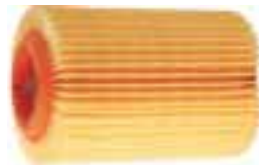

10 060 0640 

420: Ape Poker Benzina 93
(R.O. 25499)



10 060 2820 

125: Vespa Lx 4T 3V ie - Touring 12-13
• Vespa S 4T 3V ie 12
150: Vespa Lx 4T 3V ie - Touring 12-13
(R.O. B016409)



10 060 2753 

125-150: Vespa Px Sprint Veloce
VNX-VLX-VLB1T
(R.O. 113125)



10 060 2810 

200: Vespa Px
(R.O. 285352)



10 060 3030 



125: Fly 4T 3V ie E3 Dt 13-15 • Fly 4T 3V ie Eu3
Lem 12-13 • Liberty 4T 3V ie E3 13-14
150: Liberty 4T 3V Lem 13-14
(R.O. B017901)



10 060 3040 



125: Vespa Lx Primavera 4T 3V ie 13-16 • Vespa
Sprint 4T 3V ie 14-15 • **150:** Vespa Gts Super ie 4T
3V 14-15 • Vespa Lt 4T 3V ie 14 • Vespa Lx 4T 3V ie -
Touring 12-13 • Vespa Primavera 4T 3V 13-15
• Vespa Sprint 4T 3V ie 15
(R.O. B018070)



10 060 3050 



350: Beverly 4T 4V ie Eu3 Sport Touring 11-14
• X10 4T 4V ie Eu3 12-13
(R.O. 880001)





FILTRI ARIA
AIR FILTERS

PIAGGIO

SUZUKI

10 060 4980



10 060 4990



10 060 0050



1300: Porter 16V 98-09
(R.O. 1780187Z08)

1200-1400: Porter diesel 95-11
(R.O. 263703)

50: Address 92-95
(R.O. 13780-40D40-000)



10 060 0840



50: Katana 97-00 • Ayw K1-K4 01-04
• Estilete 00 • Zillion 99
(2 Pz/2 Pcs)
(R.O. 13782-35E00-000)

10 060 0940



250: Burgman K3-K6 03-06
• Burgman W-K2 98-02
400: Burgman X-K2 99-02
(R.O. 1378-14F01-000)

10 060 2520



PREFILTRO ARIA - PRE-FILTER
125-200: Burgman 07-10
(R.O. 13782-03H-000)



10 060 2530



FILTRO ARIA ESTERNO
EXTERNAL AIR FILTER
125-150: Sixteen 11
(R.O. 13785-20H00-000)

10 060 2540



125-150: Sixteen 08-11
(R.O. 13780-20H00-000)

10 060 2550



125-200: Burgman 07-10
(R.O. 13780-03H00-000)



10 060 2610



400: Burgman 07-13
(R.O. 13781-05H00-000)

10 060 2720



650: Burgman 03-13
(R.O. 13780-10G00-000)

10 060 1230



125-150: Burgman 02-06
(R.O. 13780-49F00-000)





SYM

10 060 0520 

50: Jet 99 • Jungle 99 • Red Devil 99 • Super Fancy 98-00
100: Jet 99-00
(R.O. 17205KBN900)



10 060 2570 

250: Joymax Eu 3 07 • Joymax 05-07 • Gts 07-08
300: Joymax Evo 10
(R.O. 17211HMA000)



10 060 2680 

125: Joyride 01-02
150: Attila 00-01 • Joyride 01-02
200: Joyride 03
(R.O. 17211-H6B-000)



10 060 2690 

125: Gts Joymax 06-07 • Joyride Eu2 03-06 • Joyride Eu3 07 • Joyride Evo 09-10
200: Joyride Eu2 03-06
(R.O. 17211-HLK-000)



10 060 2730 

300: Citycom
(R.O. 17211-LEA-000)



10 060 2890 

50: Fiddle II 08 • Symply 07-08
(R.O. 17211-AAA-000)



YAMAHA

10 060 2780 

125: Hd Eu2 03-04 • Hd Eu3 07-08 • Hd Evo Eu3 07-11 • Hd Evo Tamburo Eu3 08-09 • Hd Evo 05-06 • Hd2 11
200: Hd Eu2 03-04 • Hd Eu3 i 07 • Hd Evo Eu2 05-06 • Hd Evo Eu3 i 07 • Hd Evo i Eu3 10-12 • Hd Evo i Tamburo Eu3 08-09 • Hd2 i 11
(R.O. 17211HHA000)



10 060 0060 

50: Ym Breeze 94-95
(R.O. 3KJ144510000)



10 060 0310 

50: Bw'S 04-05 • Bw'S 06-10 • Bw'S 03-04 • Bw'S Naked 03-04 • Bw'S Naked 09 • Bw'S Next Generation 97-07 • Bw'S Next Generation Cat. 99-00 • Bw'S Original 97-02 • Bw'S Original Eu2 03 • Bw'S Original Eu2 02 • Bw'S R 01 • Slider 00-02 • Spy 95-98
(R.O. 3VLE44510100)



10 060 0330 

Y250: Majesty 96-98 • Majesty 00-03 • Majesty Abs 03 • Majesty Dx 98-99
(R.O. 4HC144510000)



10 060 0350 

50: Why 98 • Why 01-02 • Why 06 • Why Eu1 99-00 • Why Eu2 03-05
(R.O. 5EUE44510000)



10 060 0710 

FILTRO ARIA VARIATORE
VARIATOR AIR FILTER
125: X-City 08 • X-Max 06-09
(R.O. 5DS154070100)





FILTRI ARIA
AIR FILTERS

YAMAHA

10 060 0790 

125: Majesty 98-09 • Maxster 01-02
150: Majesty 00-02 • Maxster 01-02
180: Majesty 03-06
(R.O. 5DSE44510000)



10 060 0800 

125: Cygnus 95-98 • Cygnus R 97-99
(R.O. 4CWE44510200)



10 060 0850 

300: Versity 03-06
(R.O. 5SEE44510000)



10 060 0870 

FILTRO ARIA VARIATORE
VARIATOR AIR FILTER

125: Majesty 98-09 • Maxster 01-02 • Teo'S 00
150: Majesty 01-02 • Maxster 01-02 • Teo'S 01-02
180: Majesty 03-06
(R.O. 5DS154070100)



10 060 2000 

FILTRO ARIA VARIATORE
VARIATOR AIR FILTER

250: Majesty 96-98 • Majesty Dx 98-99
(R.O. 4HC15407-0000)



10 060 2010 

FILTRO ARIA VARIATORE
VARIATOR AIR FILTER

125: Cygnus 95-98 • Cygnus 97 • Cygnus R
00-03 • Cygnus R 97 • Cygnus R 07-99
(R.O. 4CWE54071000)



10 060 2200 

500: T-Max 01-07 • T-Max Abs 05-07 • T-Max
Black Max 06 • T-Max Black Max-Night Max 07
1100: Gts 93 • Gts A (Abs) 93
(R.O. 4BH144510100)



10 060 2330 

FILTRO ARIA SINISTRO - LEFT SIDE

400: Majesty 04-11 • Majesty Abs 07-11
• X-Max 13-14 • X-Max Abs 14
(R.O. 5RU144512000-1SDE44510000)



10 060 2340 

FILTRO ARIA DESTRO - RIGHT SIDE

400: Majesty 04-09 • Majesty Abs 07-09
• X-Max 13-14 • X-Max Abs 14
(R.O. 5RU144612000-1SDE44610000)



10 060 2350 

FILTRO ARIA VARIATORE
VARIATOR AIR FILTER

400: Majesty 04-11 • Majesty Abs 07-11
• X-Max 13-14 • X-Max Abs 14
(R.O. 5RU154070200)



10 060 2360 

500: T-Max 01-07 • T-Max Abs 05-07 • T-Max
Black Max 06 • T-Max Black Max • Night 07
(R.O. 5GJ154070100)



10 060 2370 

FILTRO ARIA PULEGGIA - PULLEY

500: T-Max 01-07 • T-Max 08-10 • T-Max Abs
05-07 • T-Max Abs 08-10 • T-Max Black Max 06
• T-Max White Max 10
(R.O. 5GJ154080000)





YAMAHA

10 060 2410 

FILTRO ARIA ASPIRAZIONE - INDUCTION

125: X-Max (Abs) 10-14 • X-City 08-11

250: X-Max 05-14 • X-City 07-14

(R.O. 1B9144510000-37PE44510000)



10 060 2420 

**FILTRO ARIA VARIATORE
VARIATOR AIR FILTER**

250: X-City 07-13 • Majesty Abs 03 • Majesty
00-03 • Black X-Max 09 • X-Max Sport 11-12
• X-Max 05-14 • X-Max Abs 11-14

300: Xc Versity 03-06

(R.O. 5GM154070000)

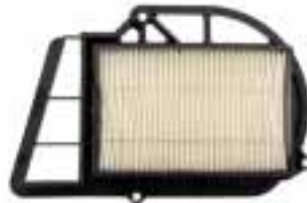

10 060 2440 

FILTRO ARIA ASPIRAZIONE - INDUCTION

500: T-Max 08-11 • T-Max Abs 08-11

• T-Max White Max 10

530: T-Max 12-13 • T-Max Abs 12-13

(R.O. 4B5144510000)

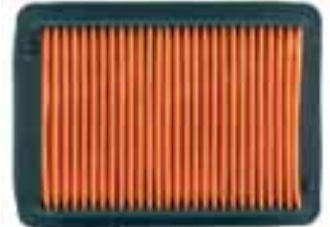

10 060 2490 

500: T-Max 08-11 • T-Max Abs 08-11 • T-Max

White Max 10-11

(R.O. 4B5154070000)



10 060 2710 

FILTRO ARIA PULEGGIA - PULLEY

530: T-Max Abs • T-Max 12

(R.O. 59C-15408-00)



10 060 2740 

125: Cygnus X 04-12

(R.O. 5TYE445110)



10 060 2790 

50: Neo's 4 09-12

(R.O. 5C3E44510000)



10 060 2860 

125-150: Xenter 12>

(R.O. 52SE445100)



10 060 2870 

FILTRO ARIA CARTER - CARTER AIR FILTER

125-150: Xenter 12>

(R.O. 52SE54080000)



10 060 2880 

FILTRO ARIA CARTER - CARTER AIR FILTER

530: T-Max Abs 12-13 • T-Max 12-13

(R.O. 59C154070000)



10 060 2930 

125: Bw's 10

(R.O. 5S9E44510000)



10 060 2990 

125: N-Max 15

(R.O. 2DPE44510000)





FILTRI ARIA QUAD
QUAD AIR FILTERS

10 060 1240 

KAWASAKI 750: Jet Force



10 060 1250 

HONDA 450: Trx



10 060 1270 

YAMAHA 700: Raptor



10 060 1280 

YAMAHA 450: Wolverine 4x4 06



10 060 2030 

YAMAHA 660: Raptor



10 060 2040 

YAMAHA 350: Warrior - Raptor
660: Grizzly



10 060 2050 

KAWASAKI 400: Kfx
SUZUKI 400



10 060 2070 

PANNELLO FILTRO ARIA QUAD:
Applicazioni Standard-mm 330 x 330 x 10

10 060 2080 

mm 330 x 330 x 15

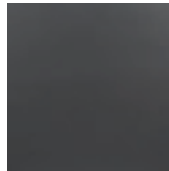

10 060 2120 

KYMCO 125-150: Maxer 02-03



10 060 2130 

KYMCO 250: Kxr 03



10 060 2140 

KAWASAKI 650-700: Prairie • 4x4 Hdw Kfx



10 060 2150 

POLARIS 330-500: Trial Boss • Predator
500-700: Scrambler 4x2-4x4
Sportman 4x4 • 4x4



10 060 2160 

YAMAHA 200: Blaster



10 060 2170 

YAMAHA 350: Yzf Banshee 2T



FILTRI ARIA - RICERCA PER MARCA

AIR FILTERS - SEARCH BY MODEL



MODELLO - MODEL	Cc	ANNI YEAR	RIF. ORIG. ORIG. REF.	CODICE RMS RMS CODE	MODELLO - MODEL	Cc	ANNI YEAR	RIF. ORIG. ORIG. REF.	CODICE RMS RMS CODE
APRILIA					Mojito Retro' • Custom	125	99-01	AP8102965	10 060 0860
Amico Gl-Gle	50	93-95	AP8201978	10 060 0010	Mojito	125	03-07	AP8577006	10 060 2560 Cinghia
Amico Lx- Sport-Cat	50	92-93	AP8201978	10 060 0010	Scarabeo Eu3	125	06-07	AP8102832	10 060 0650
Amico	50	94	AP8201978	10 060 0010	Scarabeo Light	125	07-09	JC13721X92000	10 060 2470
Amico	50	96-98	AP8201978	10 060 0010	Scarabeo Motore Rotax	125	99-03	AP8102832	10 060 0650
Area 51	50	98-00	AP8201683	10 060 0030	Scarabeo	125	03-06	AP8102832	10 060 0650
Gulliver Lc	50	96-98	AP8201683	10 060 0030	Scarabeo	125	04-06	AP8577006	10 060 2560 Cinghia
Mojito Custom	50	99-03	AP8202138	10 060 0950	Scarabeo	125	06-07	AP8577006	10 060 2560 Cinghia
Mojito Retro	50	99-03	AP8202138	10 060 0950	Sport City Cube	125	08-10	842093	10 060 2560 Cinghia
Rally Liquid Cooled	50	96-99	AP8201683	10 060 0030	Sport City Cube	125	08-10	829258	10 060 0990
Rally	50	95-03	AP8201683	10 060 0030	Sport City Eu3	125	06-08	AP8577006	10 060 2560 Cinghia
Scarabeo 4T 4V	50	10-12	AP8570092	10 060 1180 Aspirazione	Sport City Eu3	125	06-08	829258	10 060 0990
Scarabeo 4T 4V Net	50	09-10	AP8570092	10 060 1180 Aspirazione	Sport City One 4T EU3	125	08-10	842093	10 060 2560 Cinghia
Scarabeo 4T Rst Eu3	50	06-09	AP8202249	10 060 2100	Sport City	125	04-06	842093	10 060 2560 Cinghia
Scarabeo 4T	50	02-06	AP8202249	10 060 2100	Sport City	125	04-06	829258	10 060 0990
Scarabeo Ditech	50	01-04	AP8202262	10 060 2090	Sr	125	99-01	AP8102943	10 060 0120
Scarabeo Quattro	50	09	AP8570092	10 060 1180 Aspirazione	Leonardo St	150	01-04	AP8102582	10 060 0040
Scarabeo Quattro	50	09	AP8202249	10 060 2100	Leonardo	150	96-01	AP8102582	10 060 0040
Scarabeo Restyling Eu3	50	06-09	AP8570092	10 060 1180 Aspirazione	Scarabeo Motore Rotax	150	99-03	AP8102832	10 060 0650
Scarabeo	50	93-05	AP8201583	10 060 0020	Sr	150	99-01	AP8102943	10 060 0120
Sonic Gp	50	98-08	AP8201683	10 060 0030	Atlantic	200	03-05	AP8580172	10 060 0990
Sonic	50	98-07	AP8201683	10 060 0030	Atlantic Eu3	200	06-07	AP8102832	10 060 0650
Sr Ditech EU2	50	02-03	AP8202302	10 060 1300	Scarabeo Light	200	07-09	JC13721X92000	10 060 2470
Sr H2O Ditech E Carb	50	00-03	AP8202302	10 060 1300	Scarabeo Motore Rotax	200	99-03	AP8102832	10 060 0650
Sr Liquid Cooled	50	94-96	AP8201683	10 060 0030	Scarabeo	200	03	AP8102832	10 060 0650
Sr R R Factory Mod. Carbur.	50	04-09	AP8202302	10 060 1300	Sport City Cube	200	08-10	829258	10 060 0990
Sr R R Factory Mod. Purejet	50	04-09	AP8202443	10 060 1310	Sport City Eu3	200	06-08	829258	10 060 0990
Sr Stealth, Racing	50	97-99	AP8201683	10 060 0030	Sport City	200	04-06	829258	10 060 0990
Sr Street	50	03-08	AP8202302	10 060 1300	Atlantic	250	03-05	AP8580172	10 060 0990
Sr Www	50	97-01	AP8201683	10 060 0030	Atlantic Eu3	250	06-08	829258	10 060 0990
Sr	50	93	AP8201978	10 060 0010	Leonardo St	250	01	AP8102860	10 060 0660
Sr	50	94-96	AP8201683	10 060 0030	Leonardo	250	99-04	AP8102860	10 060 0660
Scarabeo 4T	100	10-12	AP8570092	10 060 1180 Aspirazione	Scarabeo Light	250	06-08	842093	10 060 2560 Cinghia
Scarabeo 4T Net	100	10	AP8570092	10 060 1180 Aspirazione	Scarabeo Light	250	06-08	829258	10 060 0990
Scarabeo 4T Net Eu3	100	10	AP8570092	10 060 1180 Aspirazione	Scarabeo	250	04-06	AP8102832	10 060 0650
Scarabeo 4T Restyling	100	06-09	AP8570092	10 060 1180 Aspirazione	Sport City Cube	250	08-10	842093	10 060 2560 Cinghia
Scarabeo 4T Rst	100	06-09	AP8202249	10 060 2100	Sport City Cube	250	08-10	829258	10 060 0990
Scarabeo 4T	100	01-04	AP8202249	10 060 2100	Sport City Eu3	250	06-08	829258	10 060 0990
Atlantic Eu3	125	06-08	AP8577006	10 060 2560 Cinghia	Atlantic	300	10	842093	10 060 2560 Cinghia
Atlantic Eu3	125	06-08	829258	10 060 0990	Leonardo	300	02-04	AP8102860	10 060 0660
Atlantic Eu3	125	10	842093	10 060 2560 Cinghia	Scarabeo Light	300	09	829258	10 060 0990
Atlantic	125	03-05	AP8577006	10 060 2560 Cinghia	Scarabeo Light	300	09-10	842093	10 060 2560 Cinghia
Atlantic	125	03-05	AP8580172	10 060 0990	Sport City Cube	300	08-10	829258	10 060 0990
Leonardo St	125	01-04	AP8102582	10 060 0040	Atlantic Sprint	400	05-08	829258	10 060 0990
Leonardo	125	96-01	AP8102582	10 060 0040	Scarabeo Light	400	06-08	829258	10 060 0990
					Atlantic	500	01-04	AP8104242	10 060 1150



FILTRI ARIA - RICERCA PER MARCA

AIR FILTERS - SEARCH BY MODEL

MODELLO - MODEL	Cc	ANNI YEAR	RIF. ORIG. ORIG. REF.	CODICE RMS RMS CODE	MODELLO - MODEL	Cc	ANNI YEAR	RIF. ORIG. ORIG. REF.	CODICE RMS RMS CODE
Atlantic Sprint	500	05-08	829258	10 060 0990	Atlantis 02 City	50	03-06	487719	10 060 0920 Aspirazione
Scarabeo Light	500	06-08	829258	10 060 0990	Atlantis 02 City	50	03-06	486942	10 060 1190 Secondario
Scarabeo	500	03-06	AP8104242	10 060 1150	Atlantis 02 Red Bullet	50	03	487719	10 060 0920 Aspirazione
Pegaso 3	650	97-00	AP8102715	10 060 2230	Atlantis 02 Red Bullet	50	03	486942	10 060 1190 Secondario
Pegaso Ie	650	01-04	AP8102715	10 060 2230	Atlantis 02 Two Chic	50	05	487719	10 060 0920 Aspirazione
ATALA					Atlantis 02 Two Chic	50	05	486942	10 060 1190 Secondario
At 10	50	-	-	10 060 0050	Atlantis 2T	50	10	487719	10 060 0920 Aspirazione
Byte	50	-	-	10 060 0050	Atlantis 2T	50	10	486942	10 060 1190 Secondario
Hacker	50	-	-	10 060 0050	Atlantis 2T Eu2	50	07-09	487719	10 060 0920 Aspirazione
Lepton	50	-	-	10 060 0680	Atlantis 2T Eu2	50	07-09	486942	10 060 1190 Secondario
Skeggia	50	-	-	10 060 0050	Atlantis 4T Eu2	50	07	832972	10 060 1180 Secondario
BENELLI					Atlantis 4T Eu2	50	07	431587	10 060 0460
491 Gt	50	98-99	R72340011AD	10 060 0060	Atlantis 50-100 4T	50	04-06	832972	10 060 1180 Secondario
491 Rr	50	98-01	R72340011AD	10 060 0060	Atlantis 50-100 4T	50	04-09	431587	10 060 0460
491 Sp	50	99	R72340011AD	10 060 0060	Atlantis Lc	50	99-01	00G03200251	10 060 0970
491 Sport	50	98-99	R72340011AD	10 060 0060	Boulevard 2T	50	09	487719	10 060 0920 Aspirazione
491 St	50	-	R72340011AD	10 060 0060	Boulevard 2T	50	09	486942	10 060 1190 Secondario
K2	50	98-01	R72340011AD	10 060 0060	Boulevard 4T Eu2 25 Km/H	50	09	832972	10 060 1180 Secondario
K2 Liquid Cooled	50	99-01	R72340011AD	10 060 0060	Boulevard 4T Eu2 25 Km/H	50	09	843194	10 060 1160
Naked	50	02	R72340011AD	10 060 0060	Gp1	50	01-03	487719	10 060 0920 Aspirazione
K2	100	99-01	R72340011AD	10 060 0060	Gp1	50	01-03	486942	10 060 1190 Secondario
Adiva	125	01-02	436478	10 060 0420	Gp1 Open Eu2	50	05-09	487719	10 060 0920 Aspirazione
Adiva	150	01-02	436478	10 060 0420	Gp1 Open Eu2	50	05-09	486942	10 060 1190 Secondario
Velvet	250	99-01	R72317001AZ	10 060 0330	Hunter	50	96-97	00G03200251	10 060 0970
Velvet Touring	250	02-03	R72317001AZ	10 060 0330	Paddock	50	98-99	00G03200251	10 060 0970
BETA					Predator Lc	50	98-01	00G03200251	10 060 0970
Ark Air	50	96-08	1525070000	10 060 0060	Predator O2	50	98-01	00G03200251	10 060 0970
Ark Lc	50	96-03	1525070000	10 060 0060	Atlantis	100	00-01	00G03200251	10 060 0970
Ark Lc Serie K	50	04-08	1525070000	10 060 0060	Atlantis 4T	100	04-06	431587	10 060 0460
Elkon	50	99-03	1525070000	10 060 0060	Atlantis 4T	100	04-06	832972	10 060 1180 Secondario
BMW					Boulevard	125	03-05	487401	10 060 0890
F-Cat - F-St	650	93-99		10 060 2220	Boulevard	125	03-04	842093	10 060 2560 Cinghia
R 45 R 50/5 R 60/5/6/7	450 500 600	78-80 69-73 69-80		10 060 2250	Boulevard	125	03-04	832703	10 060 1170 Aspirazione
R65 - R75/5/6/7 - R80/7	650-750-800	69-80		10 060 2250	Boulevard Eu3	125	04-07	487401	10 060 0890
R 90/5/6 - R100 Rs- R100/7	900-1000	73-80		10 060 2250	Boulevard Eu3	125	04-07	842093	10 060 2560 Cinghia
CAGIVA					Boulevard Eu3	125	04-07	832703	10 060 1170 Secondario
Cucciolo	50	98-99	00G03200251	10 060 0970	Boulevard 4T Eu3	125	08-09	832703	10 060 1170 Secondario
Progress	50	97-99	00G03200251	10 060 0970					
Progress Lc	50	98-99	00G03200251	10 060 0970					
DERBI									
Atlantis	50	99-01	00G03200251	10 060 0970					
Atlantis 02	50	02	487719	10 060 0920 Aspirazione					
Atlantis 02	50	02	486942	10 060 1190 Secondario					
Atlantis 02 Bullet	50	03-05	487719	10 060 0920 Aspirazione					
Atlantis 02 Bullet	50	03-05	486942	10 060 1190 Secondario					

FILTRI ARIA - RICERCA PER MARCA

AIR FILTERS - SEARCH BY MODEL



MODELLO - MODEL	Cc	ANNI YEAR	RIF. ORIG. ORIG. REF.	CODICE RMS RMS CODE	MODELLO - MODEL	Cc	ANNI YEAR	RIF. ORIG. ORIG. REF.	CODICE RMS RMS CODE
Boulevard 4T Eu3	125	08-09	843194	10 060 1160	Runner Sp	50	02-12	486942	10 060 1190 Secondario
Gp1 Eu2	125	06	842093	10 060 2560 Cinghia	Runner Sp Special Edition	50	07	487719	10 060 0920 Aspirazione
Gp1 Eu2	125	06	829258	10 060 0990	Runner Sp Special Edition	50	07	486942	10 060 1190 Secondario
Gp1 Low Seat Eu3 125-250	125	07-08	842093	10 060 2560 Cinghia	Runner Sp St & Simoncelli	50	08-09	487719	10 060 0920 Aspirazione
Gp1 Low Seat Eu3	125	07-08	829258	10 060 0990	Runner Sp St & Simoncelli	50	08-09	486942	10 060 1190 Secondario
Rambla	125	08	842093	10 060 2560 Cinghia	Stalker Mod. EU2	50	97-04	487719	10 060 0920 Aspirazione
Rambla	125	08	829258	10 060 0990	Stalker	50	97-04	479748	10 060 0110 Aspirazione
Boulevard	150	03-05	487401	10 060 0890	Stalker	50	97-11	486942	10 060 1190 Secondario
Boulevard	150	03-04	842093	10 060 2560 Cinghia	Stalker Naked	50	08	487719	10 060 0920 Aspirazione
Boulevard	150	03-04	832703	10 060 1170 Secondario	Stalker Naked	50	08	486942	10 060 1190 Secondario
Boulevard Eu3	150	04-07	487401	10 060 0890	Stalker Special Edition	50	07-08	487719	10 060 0920 Aspirazione
Boulevard Eu3	150	04-07	842093	10 060 2560 Cinghia	Stalker Special Edition	50	07-08	486942	10 060 1190 Secondario
Boulevard Eu3	150	04-07	832703	10 060 1170 Secondario	Storm	50	94-95	433437	10 060 0090
Boulevard	200	05	832703	10 060 1170 Secondario	Storm EU2	50	07	487719	10 060 0920 Aspirazione
Gp1	250	06-07	842093	10 060 2560 Cinghia	Storm EU2	50	07	486942	10 060 1190 Secondario
Gp1	250	06-07	840476	10 060 1220 Secondario	Typhoon	50	94-97	433437	10 060 0090
Gp1	250	06-07	829258	10 060 0990	Typhoon X	50	98-99	433437	10 060 0090
Gp1 Low Seat Eu3	250	07-08	842093	10 060 2560 Cinghia	Typhoon Xr	50	00	433437	10 060 0090
Gp1 Low Seat Eu3	250	07-08	829258	10 060 0990	Dna	125	01	827936	10 060 0880
Rambla	250	08	842093	10 060 2560 Cinghia	Nexus EU3	125	07-08	842093	10 060 2560 Cinghia
Rambla	250	08	829258	10 060 0990	Nexus EU3	125	07-08	829258	10 060 0990
Rambla	300	10	842093	10 060 2560 Cinghia	Nexus EU3 le	125	08-10	829258	10 060 0990
GILERA					Runner Fx-Fxr	125	97-02	480084	10 060 0120
Dna	50	05-07	487719	10 060 0920 Aspirazione	Runner Vx	125	05-06	829258	10 060 0990
Dna	50	00-02	487719	10 060 0920 Aspirazione	Runner Vx 4T EU3	125	07	829258	10 060 0990
Dna	50	05-07	486942	10 060 1190 Secondario	Runner Vx 4T St EU3	125	08-13	829258	10 060 0990
Dna	50	00-02	486942	10 060 1190 Secondario	Runner Vx Race	125	06	829258	10 060 0990
Dna Gp Experience	50	03-04	487719	10 060 0920 Aspirazione	Runner Vx Sc	125	06-07	829258	10 060 0990
Dna Gp Experience	50	03-04	486942	10 060 1190 Secondario	Runner Vx-Vxr	125	02-04	829258	10 060 0990
Easy Moving	50	95-96	431838	10 060 0430	Runner Vx-Vxr	125	00-01	827936	10 060 0880
Ice	50	01-05	487719	10 060 0920 Aspirazione	Typhoon	125	95-98	478240	10 060 0080
Ice	50	01-05	486942	10 060 1190 Secondario	Typhoon X-Xr	125	99-00	478240	10 060 0080
Runner	50	97-00	479748	10 060 0110 Aspirazione	Dna	180	01	827936	10 060 0880
Runner Poggiali	50	02	487719	10 060 0920 Aspirazione	Runner Fx-Fxr	180	97-02	480084	10 060 0120
Runner Poggiali	50	02	486942	10 060 1190 Secondario	Runner Vx-Vxr	180	00-01	827936	10 060 0880
Runner Purejet	50	02-07	479748	10 060 0110 Aspirazione	Runner Vx-Vxr	200	02-04	829258	10 060 0990
Runner Purejet St	50	08	479748	10 060 0110 Aspirazione	Runner Vxr	200	05-06	829258	10 060 0990
Runner Sp	50	02-12	487719	10 060 0920 Aspirazione	Runner Vxr 4T St EU3	200	08-11	829258	10 060 0990
					Runner Vxr EU3	200	07	829258	10 060 0990
					Runner Vxr Race	200	06	829258	10 060 0990
					Nexus EU3	250	06-07	842093	10 060 2560 Cinghia
					Nexus EU3	250	06-07	829258	10 060 0990



FILTRI ARIA - RICERCA PER MARCA

AIR FILTERS - SEARCH BY MODEL

MODELLO - MODEL	Cc	ANNI YEAR	RIF. ORIG. ORIG. REF.	CODICE RMS RMS CODE
Nexus Sp EU3	250	06-07	842093	10 060 2560 Cinghia
Nexus Sp EU3	250	06-07	829258	10 060 0990
Nexus EU3	300	09-11	842093	10 060 2560 Cinghia
Nexus EU3	300	09-11	829258	10 060 0990
Fuoco	500	07-09	829258	10 060 0990
Fuoco 4T-4V le E3 Lt	500	13	829258	10 060 0990
Fuoco Eu3	500	07-13	829258	10 060 0990
Nexus	500	03-05	487845	10 060 1140
Nexus EU3	500	09-11	487845	10 060 1140
Nexus Sp EU3	500	06-07	487845	10 060 1140
GUZZI				
Nevada-Club -V35-V35 II-III	350	91-98		10 060 2240
Imola-Florida-Imola II-Custom-Gt-TT-Ntx V35	-	-		10 060 2240
Florida-Imola II -Florida-Imola II	-	88		10 060 2240
V50-Polizia-II-III Custom Monza - S3-T3 - T3-California T4	500-750-850	-		10 060 2240
Cx100V10-V-Convert-G5-Sp	1000	-		10 060 2240
California (28113660) - California	1000	94		10 060 2280
Classic-Le Mans- Le Mans C.I.-Le Mans N	-	-		10 060 2280
California III IE (28113660)-Le Mans III-Srl-Sc-Sp III	-	-		10 060 2280
Daytona le-le VII-Biposto VII-Quota	1000	-		10 060 2300
le V10 Centauro le Gt-Sport-California le VIII Serie	-	-		10 060 2300
California-le-Ev 1,1 le-Jackal 1,1	1100	-		10 060 2300
le-Special 1,1 le Quota 1,1 le (V90 2 Valvole/	-	-		10 060 2300
Valves-V11-Cafè Sport Le Mans-Le Mans Rosso	-	-		10 060 2300
Corse-V11 Sport-Sport - Sport Ballabio - Sport-Sport le	-	-		10 060 2300
HONDA				
Sfx V	50	95		10 060 0230
Sh	50	91-95		10 060 0140
Sh	50	96		10 060 0200
Sj Bali	50	93		10 060 0170
Sky	50	97		10 060 0210
Vision	50	11-13	17210-KZL-930	10 060 2840
Sh	100	96-99		10 060 0200
Sj Bali	100	96-99		10 060 0170
Vision	110	11-13	17210-KZL-930	10 060 2840
Chiocciola	125	00-06		10 060 1131
Dylan	125	01-06		10 060 1131
Pantheon 2T	125	98-02		10 060 0810

MODELLO - MODEL	Cc	ANNI YEAR	RIF. ORIG. ORIG. REF.	CODICE RMS RMS CODE
Ps I	125	06-08		10 060 1131
Sh 125	125	01-08		10 060 1131
Sh 125I	125	01-08		10 060 1131
Sh	125	13>	17210-K01-900	10 060 2850
Pantheon	125	03-07		10 060 2650
Pcx	125	11	17210-KWN-900	10 060 2660
Pcx	125	12>	17210-KZR-600	10 060 2770
Pantheon	150	03-07		10 060 2650
Silver Wing	125	07-10		10 060 2650
Silver Wing	150	07-10		10 060 2650
Chiocciola	150	00-06		10 060 1131
Dylan	150	01-06		10 060 1131
Pantheon 2T	150	98-02		10 060 0810
Pcx	150	12>	17210-KZR-600	10 060 2770
Ps I	150	06-08		10 060 1131
Sh 150	150	01-08		10 060 1131
Sh 150I	150	01-08		10 060 1131
Sh	150	13>	17210-K01-900	10 060 2850
Foresight	250	98		10 060 0780
Forza	250	05-07		10 060 2640
Sh I	300	07-08		10 060 2380
Silver Wing	400	06-08	17230-MCT--00	10 060 2630
Silver Wing Abs	400	06-08	17230-MCT--00	10 060 2630
Silver Wing Abs	600	09-10	17230-MCT--00	10 060 2630
Nc Integra	700	12-13	17210-MGS-D30	10 060 2900
Nc Integra	750	14	17210-MGS-D30	10 060 2900
ITALJET				
Formula Lc	50	97>	-	10 060 0240 2 Pezzi
Dragster	125	99-03	210480084	10 060 0120
Formula	125	-	-	10 060 0240 2 Pezzi
Millennium	125	-	-	10 060 0790
Torpedo	125	98-00	210436478	10 060 0420
Torpedo (Motore Leader)	125	00-03	210436478	10 060 0420
Millennium	150	-	-	10 060 0790
Torpedo (Motore Leader)	150	00-03	210436478	10 060 0420
Dragster	180	99-03	210480084	10 060 0120
KYMCO				
Agility 4T R10	50	06-08	163126	10 060 2400
Agility 4T R12	50	07-08	164044	10 060 2390
Agility 4T R16	50	08-12	101074	10 060 2450
Agility R12	50	05	164044	10 060 2390
Agility Rs	50	09	164044	10 060 2390
Agility 4T Carry	50	11	164044	10 060 2390
B&W	50	02	163571	10 060 1320
B&W EU2	50	03	163571	10 060 1320
Cx	50	93	00163101 + 00163013	10 060 0270 2 Pezzi
Cx Super	50	94-97	00163101 + 00163013	10 060 0270 2 Pezzi
Dink 50 4T	50	07	101074	10 060 2450
Dink Classic EU2	50	03	163571	10 060 1320

FILTRI ARIA - RICERCA PER MARCA

AIR FILTERS - SEARCH BY MODEL



MODELLO - MODEL	Cc	ANNI YEAR	RIF. ORIG. ORIG. REF.	CODICE RMS RMS CODE	MODELLO - MODEL	Cc	ANNI YEAR	RIF. ORIG. ORIG. REF.	CODICE RMS RMS CODE
Dink Lc	50	98-02	163571	10 060 1320	People S	125	05	162377	10 060 2310
Dj W	50	94-00	00163101 + 00163013	10 060 0270 2 Pezzi	People S Dd EU3	125	07-08	162377	10 060 2310
Dj X	50	91-92	00163101 + 00163013	10 060 0270 2 Pezzi	People Gti	125	10	00117303	10 060 2670
Djy	50	93	00163101 + 00163013	10 060 0270 2 Pezzi	Super 8	125	09	162377	10 060 2310
Fever Zx	50	99-00	163892	10 060 0280	Agility R16	150	08-09	162377	10 060 2310
Fever Zx EU2	50	03-04	163892	10 060 0280	Dink Classic	150	02	162993	10 060 0730
Heroism	50	95-97	166204	10 060 0260	Dink Classic EU2	150	03	162993	10 060 0730
Like	50	09	00117213	10 060 2700	Dink Lx	150	98-00	162993	10 060 0730
K12	50	95-00	163892	10 060 0280	Grand Dink	150	01-02	162475	10 060 0740
Kb	50	95-00	163892	10 060 0280	Grand Dink EU2	150	03-04	162475	10 060 0740
People	50	04	162309	10 060 1330	Movie 150 EU3	150	06-07	163996	10 060 9340
People	50	99-00	162309	10 060 1330	Movie XI	150	01	163996	10 060 9340
People EU2	50	08	162309	10 060 1330	Movie XI EU2	150	03-04	163996	10 060 9340
People EU2	50	03	162309	10 060 1330	People	150	99-00	162377	10 060 2310
People S	50	05-08	162309	10 060 1330	People EU2	150	03	162377	10 060 2310
People S 4T	50	06-08	101074	10 060 2450	Agility 2001 R16	200	10	162377	10 060 2310
Sento	50	08	101074	10 060 2450	Agility I Plus	200	14	162377	10 060 2310
Sniper	50	93	166204	10 060 0260	Agility R16	200	12	162377	10 060 2310
Sniper Dd	50	94-96	166204	10 060 0260	Dink Classic	200	04	162993	10 060 0730
Super 8	50	07-13	101074	10 060 2450	Dink EU3I	200	06-07	162475	10 060 0740
Super 8 2T	50	09-13	162309	10 060 1330	Downtown I	200	10	117199	10 060 2580
Super 8 4T	50	09	101074	10 060 2450	Like	200	09	117221	10 060 2800
Super 9	50	00	163571	10 060 1320	Like Lx	200	12	117221	10 060 2800
Super 9 Sport EU2	50	03-04	163571	10 060 1320	People S	200	05	162377	10 060 2310
Top Boy	50	97-00	163571	10 060 1320	People S 200I	200	07	162377	10 060 2310
Vitality 2T	50	04	163571	10 060 1320	People Gti	200	10-14	00117303	10 060 2670
Vitality 4T	50	04	164044	10 060 2390	Grand Dink	250	01-02	162475	10 060 0740
Yup	50	02	163571	10 060 1320	Grand Dink EU2	250	03-04	162475	10 060 0740
Yup EU2	50	03	163571	10 060 1320	People Lc	250	03-04	162380	10 060 2430
Agility Plus	125	14	162377	10 060 2310	People S	250	06	162380	10 060 2430
Agility R16	125	09-12	162377	10 060 2310	People S 250I	250	07	162380	10 060 2430
Dink 125 EU3	125	06-07	162475	10 060 0740	X Citing	250	05	162475	10 060 0740
Dink 125-150	125	97-98	162953	10 060 0750	X Citing I	250	06-07	162475	10 060 0740
Dink Classic	125	02	162993	10 060 0730	Downtown I	300	09-11	117245	10 060 2590
Dink Classic EU2	125	03	162993	10 060 0730	Downtown Abs - I	300	10-11	117245	10 060 2590
Dink Lx	125	98-00	162993	10 060 0730	G-Dink	300	12>	117409	10 060 2760
Downtown I	125	09	117199	10 060 2580	K-Xct I	300	12	001174469	10 060 2830
G-Dink	125	12>	117409	10 060 2760	People S 300I	300	08	162380	10 060 2430
Grand Dink Eu2	125	03-04	162475	10 060 0740	People Gti	300	10-11	00117303	10 060 2670
K-Xct I	125	12	001174469	10 060 2830	People Gti Abs	300	12-14	00117303	10 060 2670
Like	125	09	117221	10 060 2800	X Citing 300I	300	08	162475	10 060 0740
Like Lx	125	12	117221	10 060 2800	X Citing 300I R	300	08-09	162475	10 060 0740
Movie 125 EU3	125	06-07	163996	10 060 9340	X Citing I - Abs	400	13-15	00117492	10 060 2980
Movie XI	125	01	163996	10 060 9340	X Citing I	400	13-15	00117492	10 060 2980
Movie XI EU2	125	03-04	163996	10 060 9340	X Citing R	500	09	00163096	10 060 2920
People 125-150	125	99-00	162377	10 060 2310	X Citing I R	500	07-08	00163096	10 060 2920
People EU2	125	03	162377	10 060 2310	X Citing I	500	06-08	00163096	10 060 2920
People EU3	125	07-11	162377	10 060 2310	X Citing	500	05	00163096	10 060 2920
People One I	125	13	162377	10 060 2310	MALAGUTI				
					Centro Base	50	93-94	6604500	10 060 0060
					Centro SI	50	94-98	6604500	10 060 0060
					Centro SI Kat	50	99-00	6604500	10 060 0060



FILTRI ARIA - RICERCA PER MARCA

AIR FILTERS - SEARCH BY MODEL

MODELLO - MODEL	Cc	ANNI YEAR	RIF. ORIG. ORIG. REF.	CODICE RMS RMS CODE	MODELLO - MODEL	Cc	ANNI YEAR	RIF. ORIG. ORIG. REF.	CODICE RMS RMS CODE
Ciak	50	99-00	6609100	10 060 0830	Madison	125	99-01	6612400	10 060 0790
Ciak Master	50	04	6609100	10 060 0830	Madison 3	125	06-09	6614100	10 060 0990
Ciak Master EU2	50	06	6609100	10 060 0830	Madison R Rst	125	02	6612400	10 060 0790
Ciak Mono EU2	50	03	6609100	10 060 0830	Madison R Rst EU2	125	03-04	6612400	10 060 0790
Ciak Mono EU2 2.3	50	03	6609100	10 060 0830	Phantom Max	125	03	6612400	10 060 0790
Ciak Td	50	00-01	6609100	10 060 0830	Ciak	150	00-02	6611003	10 060 2310
Crosser Cr1	50	95-98	6605500	10 060 0290	Ciak Master	150	04	6611003	10 060 2310
F10 Ac	50	08	6604500	10 060 0060	Ciak Rst EU2	150	03	6611003	10 060 2310
F10 Ac Eco	50	09	6604500	10 060 0060	F18 Warrior	150	00-02	6610300	10 060 1200
F10 Jet Line	50	92-98	6604500	10 060 0060	Madison T	150	99-01	6612400	10 060 0790
F10 Kat	50	99-00	6604500	10 060 0060	Blog le	160	09-10	65046700	10 060 2500
F10 Rst Eu1	50	01-02	6604500	10 060 0060	Centro le	160	08-09	65046700	10 060 2500
F10 Rst Eu2-2.3	50	03-04	6604500	10 060 0060	Centro SI le	160	09-10	65046700	10 060 2500
F10 Rst EU2	50	06	6604500	10 060 0060	Ciak Master EU2	200	06	6611003	10 060 2310
F10 Rst EU2	50	02-03	6604500	10 060 0060	Madison S Rst	200	02	6614100	10 060 0990
F12 Aria Rst EU2	50	06	6604500	10 060 0060	Madison S Rst EU2	200	03	6614100	10 060 0990
F12 Lc Rst EU2	50	06	6604500	10 060 0060	Phantom Max	200	03	6614100	10 060 0990
F12 Phantom	50	94-98	6604500	10 060 0060	Madison 3	250	06-09	6614100	10 060 0990
F12 Phantom Euro1	50	99-00	6604500	10 060 0060	Madison Rs Rst	250	04	6614100	10 060 0990
F12 Phantom Lc	50	94-98	6604500	10 060 0060	Madison S	250	99-01	6608100	10 060 0330
F12 Phantom Lc Euro1	50	99-00	6604500	10 060 0060	Madison S	250	99-01	6607900	10 060 2000 Variatore
F12 Phantom Lc Rst Eu1	50	01-02	6604500	10 060 0060	Password	250	05-06	6626100	10 060 1210
F12 Phantom Lc Rst Eu2	50	02	6604500	10 060 0060	Password Eu3	250	07-08	6626100	10 060 1210
F12 Phantom Lc Rst Eu2-2.3	50	03-04	6604500	10 060 0060	Phantom Max	250	04	6614100	10 060 0990
F12 Phantom Lc Twin Disks	50	98	6604500	10 060 0060	Madison K	400	02	6611700	10 060 2020
F12 Phantom Rst Eu1	50	01-02	6604500	10 060 0060	Madison K Rst	400	02-04	6611700	10 060 2020
F12 Phantom Rst Eu2	50	02	6604500	10 060 0060	Spidermax Gt	500	04-05	6615400	10 060 1140
F12 Phantom Rst Eu2-2.3	50	03-04	6604500	10 060 0060	Spidermax Gt EU3	500	06	6615400	10 060 1140
F12R Phantom Ac	50	07-09	6604500	10 060 0060	Spidermax Rs	500	08	6615400	10 060 1140
F12R Phantom Lc	50	07-09	604500	10 060 0060	MBK				
F15 Fire Fox	50	96-98	6606600	10 060 0300	Cw Booster	50	90-91	3VLE44510100	10 060 0310
F15 Fire Fox Air Cooled	50	05-06	6604500	10 060 0060	Cw Booster	50	01-04	3VLE44510100	10 060 0310
F15 Fire Fox EU2	50	02-03	6604500	10 060 0060	Cw Booster [I]	50	92-94	3VLE44510100	10 060 0310
F15 Fire Fox Rst EU2-2.3	50	03-04	6604500	10 060 0060	Cw Booster Naked	50	03	3VLE44510100	10 060 0310
F15 Fire Fox Twin Disks	50	98-99	6606600	10 060 0300	Cw Booster Spirit	50	96-98	3VLE44510100	10 060 0310
F15 Fire Fox Twin Disks Kat	50	98-00	6606600	10 060 0300	Cw Booster Spirit [I]	50	99-00	3VLE44510100	10 060 0310
F15 Lc Rst EU2	50	04-05	6604500	10 060 0060	Cw Booster Spirit EU2	50	02-03	3VLE44510100	10 060 0310
F15 Lc-Tds Rst Euro 1	50	01	6606600	10 060 0300	Cw L Booster	50	01-03	3VLE44510100	10 060 0310
Yesterday • Yesterday Euro	50	97-00	6604500	10 060 0060	Cw L Booster Spirit	50	03	3VLE44510100	10 060 0310
Ciak	100	99-00	6608800	10 060 0820	Cw R Booster Road (Ita)	50	94-95	3VLE44510100	10 060 0310
F12 Phantom	100	99-00	6608800	10 060 0820	Cw Rs Booster Ng	50	01-03	3VLE44510100	10 060 0310
Arcore	125	08-09	65046700	10 060 2500	Cw Rs Booster Ng [I]	50	95-99	3VLE44510100	10 060 0310
Arn	125	09-10	65046700	10 060 2500	Cw Rs Booster Ng Euro1	50	99-00	3VLE44510100	10 060 0310
Blog le	125	09-10	65046700	10 060 2500	Cw Rsp Booster Rocket [I]	50	97-98	3VLE44510100	10 060 0310
Ciak	125	00-01	6611003	10 060 2310	Cw Rxs Booster Track [I]	50	96-98	3VLE44510100	10 060 0310
Ciak Master	125	04	6611003	10 060 2310	Cw Sp Booster Spirit EU2	50	02	3VLE44510100	10 060 0310
Ciak Master EU3	125	06	6611003	10 060 2310	Ew Stunt	50	00-02	3VLE44510100	10 060 0310
Ciak Rst EU2	125	03	6611003	10 060 2310	Ye Evolis [I]	50	92-95	3KJ144510000	10 060 0060
F18 Warrior	125	00-02	6610300	10 060 1200	Yh Flipper	50	01-02	5EUE44510000	10 060 0350
					Yh Flipper	50	98	5EUE44510000	10 060 0350
					Yh Flipper Catalitico	50	99-00	5EUE44510000	10 060 0350

FILTRI ARIA - RICERCA PER MARCA

AIR FILTERS - SEARCH BY MODEL



MODELLO - MODEL	Cc	ANNI YEAR	RIF. ORIG. ORIG. REF.	CODICE RMS RMS CODE	MODELLO - MODEL	Cc	ANNI YEAR	RIF. ORIG. ORIG. REF.	CODICE RMS RMS CODE
Yh Flipper EU2	50	03-04	5EUE44510000	10 060 0350	Speedfight Aria Cata- litico	50	99	730199	10 060 0370
Ym Fizz [I]	50	94-95	3KJ144510000	10 060 0060	Squab	50	95-97	730199	10 060 0370
Xc Flame F	125	00	4CWE54071000	10 060 2010 Variatore	St Rapido	50	85-93	751537	10 060 0380
Xc K Flame R	125	96-99	4CWE44510200	10 060 0800	Sv Geo	50	91-95	724064	10 060 0360
Xc K Flame R	125	96-99	4CWE54071000	10 060 2010 Variatore	Trekker	50	98-00	730199	10 060 0370
Xc T Flame	125	95-99	4CWE44510200	10 060 0800	Trk2 Wrc	50	04-06	730199	10 060 0370
Xc T Flame	125	95-99	4CWE54071000	10 060 2010 Variatore	V-Click 4T	50	08	-	10 060 0520
Xn Doodo	125	00-01	5DS154070100	10 060 0870 Variatore	Vivacity	50	99	730199	10 060 0370
Xq Thunder	125	01-02	5DSE44510000	10 060 0790 Variatore	Vivacity 2T EU2	50	09	-	10 060 2480
Xq Thunder	125	01-02	5DS154070100	10 060 0870 Variatore	Vivacity Catalitico	50	99-02	730199	10 060 0370
Yp E Skyliner	125	03	5DSE44510000	10 060 0790 Variatore	Vivacity Vsx-Xr	50	02-04	730199	10 060 0370
Yp E Skyliner	125	03	5DS154070100	10 060 0870 Variatore	X-Fight	50	00	730199	10 060 0370
Yp Skyliner	125	98-02	5DSE44510000	10 060 0790 Variatore	Xr7	50	08	-	10 060 0510
Yp Skyliner	125	98-02	5DS154070100	10 060 0870 Variatore	Xrace	50	03	730199	10 060 0370
Xn Doodo	150	01-02	5DS154070100	10 060 0870 Variatore	Zenith L	50	94-96	730199	10 060 0370
Xq Thunder	150	01-02	5DSE44510000	10 060 0790 Variatore	Zenith Ln-Ls	50	97-98	730199	10 060 0370
Xq Thunder	150	01-02	5DS154070100	10 060 0870 Variatore	Zenith N	50	97-98	730199	10 060 0370
Yp Skyliner	150	00-02	5DSE44510000	10 060 0790 Variatore	Elyseo	100	99-01	737351	10 060 0700
Yp Skyliner	150	00-02	5DS154070100	10 060 0870 Variatore	Looxor	100	01	737351	10 060 0700
Yp E Skyliner	180	03	5DSE44510000	10 060 0790 Variatore	Speedfight	100	97-00	737351	10 060 0700
Yp E Skyliner	180	03	5DS154070100	10 060 0870 Variatore	Sv L	100	98	724064	10 060 0360
Yp Skyliner	250	00-03	5GM154070000	10 060 2420 Variatore	Trekker	100	98	737351	10 060 0700
Yp Skyliner	250	00-03	4HC144510000	10 060 0330	Vivacity	100	99-01	737351	10 060 0700
Yp Skyliner Abs	250	03	5GM154070000	10 060 2420 Variatore	X-Fight	100	00-01	737351	10 060 0700
Yp Skyliner Abs	250	03	4HC144510000	10 060 0330	Elyseo	125	99-00	737534	10 060 0690
Xc Kilibre	300	03	5GM154070000	10 060 2420 Variatore	Elyseo	125	01	737534	10 060 0690
Xc Kilibre	300	03	5SEE44510000	10 060 0850	Elystar	125	02-03	737534	10 060 0690
PEUGEOT					Geopolis	125	07>	-	10 060 0530
Buxy	50	94-97	730199	10 060 0370	Looxor	125	02-03	747486	10 060 0930
Elyseo	50	99	730199	10 060 0370	Elyseo	150	01	737534	10 060 0690
Elystar Tsdì	50	03-05	730199	10 060 0370	Elystar	150	02-03	737534	10 060 0690
Fox	50	94-98	727905	10 060 0390	Looxor	150	02-03	747486	10 060 0930
Looxor	50	01-03	730199	10 060 0370	Sv	250	01-02	754306	10 060 0780
Looxor Tsdì	50	02	730199	10 060 0370	PIAGGIO				
Metal-X	50	02	730199	10 060 0370	Ape EU2	50	03-10	290569	10 060 0610
Sc Metropolis Lm-Sxlm	50	<91	705260	10 060 0130	Ape EU2	50	03-10	486942	10 060 1190 Secondario
Speedake	50	95-97	730199	10 060 0370	Ape Fl • Fl2	50	89-95	290569	10 060 0610
Speedfight 2 Aria	50	05-06	730199	10 060 0370	Ape Fl3 Europa	50	96-99	290569	10 060 0610
Speedfight 2 Lc 307Wrc	50	05-06	730199	10 060 0370	Ape P	50	80-85	290569	10 060 0610
Speedfight Acqua	50	97-98	730199	10 060 0370	Ape Rst Mix	50	99-05	290569	10 060 0610
Speedfight Aria	50	97-98	730199	10 060 0370	Ape Tm P	50	85-89	290569	10 060 0610
					Diesìs	50	01	487719	10 060 0920 Aspirazione
					Diesìs	50	01	486942	10 060 1190 Secondario
					Fly 2T	50	05-07	487719	10 060 0920 Aspirazione
					Fly 2T	50	05-07	486942	10 060 1190 Secondario
					Fly 4T Motore Chn	50	06-07	843194	10 060 1160
					Fly 4T Motore Chn	50	06-07	832972	10 060 1180 Secondario
					Fly 4T	50	05-08	843194	10 060 1160



FILTRI ARIA - RICERCA PER MARCA

AIR FILTERS - SEARCH BY MODEL

MODELLO - MODEL	Cc	ANNI YEAR	RIF. ORIG. ORIG. REF.	CODICE RMS RMS CODE	MODELLO - MODEL	Cc	ANNI YEAR	RIF. ORIG. ORIG. REF.	CODICE RMS RMS CODE
Fly 4T	50	05-08	832972	10 060 1180 Secondario	Nrg Power Dt	50	06-08	487719	10 060 0920 Aspirazione
Free Delivery	50	00-01	431587	10 060 0460	Nrg Power Dt	50	06-08	486942	10 060 1190 Secondario
Free Fl	50	95-02	431587	10 060 0460	Nrg Power Purejet	50	04-08	479748	10 060 0110 Aspirazione
Free	50	92-94	431587	10 060 0460	Nrg Purejet	50	02-04	479748	10 060 0110 Aspirazione
Liberty 2T Rst	50	04	487719	10 060 0920 Aspirazione	Nrg Rst Mc2	50	96-98	433437	10 060 0090
Liberty 2T Rst	50	04	486942	10 060 1190 Secondario	Nrg Rst Mc2	50	96-98	479748	10 060 0110 Aspirazione
Liberty 2T Sport	50	06-08	487719	10 060 0920 Aspirazione	Nrg	50	94-96	433437	10 060 0090
Liberty 2T Sport	50	06-08	486942	10 060 1190 Secondario	Ntt	50	95-96	433437	10 060 0090
Liberty 2T	50	06-08	487719	10 060 0920 Aspirazione	Quartz	50	92-96	431780	10 060 0480
Liberty 2T	50	06-08	486942	10 060 1190 Secondario	Sfera Maquillage 2	50	94	257369	10 060 0410
Liberty 4T Delivery Tnt	50	09	875525	10 060 0910	Sfera Rst	50	95-97	436478	10 060 0420
Liberty 4T Delivery Tnt	50	09	832972	10 060 1180 Secondario	Sfera	50	91-93	257369	10 060 0410
Liberty 4T Rst	50	04	487287	10 060 0910	Typhoon	50	01-04	487719	10 060 0920 Aspirazione
Liberty 4T Rst	50	04	832972	10 060 1180 Secondario	Typhoon	50	05-08	487719	10 060 0920 Aspirazione
Liberty 4T Sport	50	06-08	487287	10 060 0910	Typhoon	50	05-09	486942	10 060 1190 Secondario
Liberty 4T Sport	50	06-08	832972	10 060 1180 Secondario	Typhoon	50	09	487719	10 060 0920 Aspirazione
Liberty 4T	50	00-02	487287	10 060 0910	Vespa Et2 Iniezione	50	97-00	436478	10 060 0420
Liberty 4T	50	05-08	487287	10 060 0910	Vespa Et2	50	97-05	436478	10 060 0420
Liberty 4T	50	05-08	832972	10 060 1180 Secondario	Vespa Et2	50	97-05	486942	10 060 1190 Secondario
Liberty Moc 2T	50	09	487719	10 060 0920 Aspirazione	Vespa Et4	50	00-05	487401	10 060 0890
Liberty Moc 2T	50	09	486942	10 060 1190 Secondario	Vespa Et4	50	00-05	832972	10 060 1180 Secondario
Liberty Moc 4T	50	09	875525	10 060 0910	Vespa FL	50	90	287155	10 060 0600
Liberty Moc 4T	50	09	832972	10 060 1180 Secondario	Vespa FL2 Hp	50	91-97	287155	10 060 0600
Liberty Ptt Eu2	50	04-05	487719	10 060 0920 Aspirazione	Vespa Lx 2T FL	50	09-10	487719	10 060 0920 Aspirazione
Liberty Ptt Eu2	50	04-05	486942	10 060 1190 Secondario	Vespa Lx 2T FL	50	09-10	486942	10 060 1190 Secondario
Liberty	50	97-05	482738	10 060 0400	Vespa Lx 2T	50	09-13	487719	10 060 0920 Aspirazione
Liberty	50	97-05	486942	10 060 1190 Secondario	Vespa Lx 2T	50	05-08	486942	10 060 1190 Secondario
Nrg Extreme	50	99-00	479748	10 060 0110 Aspirazione	Vespa Lx 4T	50	05-08	843194	10 060 1160
Nrg Mc3	50	01-04	487719	10 060 0920 Aspirazione	Vespa Lx 4T	50	05-08	832972	10 060 1180 Secondario
Nrg Mc3	50	01-04	479748	10 060 0110 Aspirazione	Vespa Lx 4T-4V	50	09-13	843194	10 060 1160
Nrg Mc3	50	01-04	486942	10 060 1190 Secondario	Vespa Lx 4T-4V	50	09-13	832972	10 060 1180 Secondario
Nrg Power Dd Serie Spec	50	07-08	487719	10 060 0920 Aspirazione	Vespa Lxv 2T Navy	50	08	487719	10 060 0920 Aspirazione
Nrg Power Dd Serie Spec	50	07-08	486942	10 060 1190 Secondario	Vespa Lxv 2T Navy	50	08	486942	10 060 1190 Secondario
Nrg Power Dd	50	05-09	487719	10 060 0920 Aspirazione	Vespa Lxv 2T	50	06-09	487719	10 060 0920 Aspirazione
Nrg Power Dd	50	05-09	486942	10 060 1190 Secondario	Vespa Lxv 2T	50	06-09	486942	10 060 1190 Secondario
Nrg Power Dt Serie Spec	50	07-08	487719	10 060 0920 Aspirazione	Vespa S 2T	50	07-08	487719	10 060 0920 Aspirazione
Nrg Power Dt Serie Spec	50	07-08	486942	10 060 1190 Secondario	Vespa S 2T	50	07-08	486942	10 060 1190 Secondario
Nrg Power Dt Serie Spec	50	07-08	487719	10 060 0920 Aspirazione	Vespa S 4T-4V	50	08-09	843194	10 060 1160
Nrg Power Dt Serie Spec	50	07-08	486942	10 060 1190 Secondario	Vespa S 4T-4V	50	08-09	832972	10 060 1180 Secondario

FILTRI ARIA - RICERCA PER MARCA

AIR FILTERS - SEARCH BY MODEL



MODELLO - MODEL	Cc	ANNI YEAR	RIF. ORIG. ORIG. REF.	CODICE RMS RMS CODE	MODELLO - MODEL	Cc	ANNI YEAR	RIF. ORIG. ORIG. REF.	CODICE RMS RMS CODE
Zip 2T	50	08-09	487719	10 060 0920 Aspirazione	Hexagon	125	94-97	434364+434363	10 060 0470 2 pezzi
Zip 2T	50	08-09	486942	10 060 1190 Secondario	Hexagon Gtx 125-180	125	00	487845	10 060 1140
Zip 4T	50	00-08	834741	10 060 0430	Hexagon Lx4	125	98-99	436478	10 060 0420
Zip 4T	50	00-08	832972	10 060 1180 Secondario	Hexagon Lx-Lxt	125	98-99	434364+434363	10 060 0470 2 pezzi
Zip Fast Raider Rst	50	96-97	478536	10 060 0440	Liberty 4T 3V IE Eu3	125	13-14	8017901	10 060 3030
Zip Fast Raider	50	93-94	431838	10 060 0430	Liberty 4T EU3 Delivery	125	08	487287	10 060 0910
Zip Rst	50	96-99	478536	10 060 0440	Liberty 4T EU3 Delivery	125	08	832703	10 060 1170 Secondario
Zip Sp EU2	50	06-09	487719	10 060 0920 Aspirazione	Liberty 4T EU3	125	07-08	487287	10 060 0910
Zip Sp EU2	50	06-09	486942	10 060 1190 Secondario	Liberty 4T EU3	125	07-08	832703	10 060 1170 Secondario
Zip Sp	50	01-04	487719	10 060 0920 Aspirazione	Liberty 4T Sport EU3	125	06-08	842093	10 060 2560 Cinghia
Zip Sp	50	96-00	478536	10 060 0440	Liberty 4T Sport EU3	125	06-08	487287	10 060 0910
Zip	50	00-04	487719	10 060 0920 Aspirazione	Liberty 4T Sport EU3	125	06-08	832703	10 060 1170 Secondario
Zip	50	00-04	486942	10 060 1190 Secondario	Liberty 4T	125	06-07	842093	10 060 2560 Cinghia
Zip	50	92-93	834741	10 060 0430	Liberty 4T	125	06-07	487287	10 060 0910
Zip	50	95-96	431838	10 060 0430	Liberty 4T	125	06-07	832703	10 060 1170 Secondario
Skr City	80	99	478240	10 060 0080	Liberty Moc 4T & Elle	125	09-10	842093	10 060 2560 Cinghia
Fly 4T	100	06-08	843194	10 060 1160	Liberty Moc 4T	125	09	843194	10 060 1160
Fly 4T	100	06-08	832972	10 060 1180 Secondario	Liberty Moc 4T	125	09	832703	10 060 1170 Secondario
Free	100	02-03	431587	10 060 0460	Liberty Rst Ptt	125	05-06	842093	10 060 2560 Cinghia
Zip 4T	100	06-08	834741	10 060 0430	Liberty Rst Ptt	125	05-06	487287	10 060 0910
Zip 4T	100	06-08	832972	10 060 1180 Secondario	Liberty Rst Ptt	125	05-06	832703	10 060 1170 Secondario
Beverly EU3 Mic	125	07	842093	10 060 2560 Cinghia	Liberty Rst	125	04-05	487287	10 060 0910
Beverly EU3 Mic	125	07	829258	10 060 0990	Liberty Rst	125	04-05	832703	10 060 1170 Secondario
Beverly EU3 Sport	125	07-08	842093	10 060 2560 Cinghia	Liberty Sport	125	06	842093	10 060 2560 Cinghia
Beverly EU3 Sport	125	07-08	829258	10 060 0990	Liberty Sport	125	06	875525	10 060 0910
Beverly EU3	125	07-08	842093	10 060 2560 Cinghia	Liberty Sport	125	06	832703	10 060 1170 Secondario
Beverly EU3	125	07-08	829258	10 060 0990	Liberty	125	01-02	487287	10 060 0910
Beverly Rst	125	04-07	842093	10 060 2560 Cinghia	Liberty	125	98-00	436478	10 060 0420
Beverly Rst	125	04-07	829258	10 060 0990	Mp3 Ibrido	125	09	831997	10 060 2110
Beverly Tourer EU3	125	08-09	829258	10 060 0990	Mp3 le	125	08-09	831997	10 060 2110
Beverly Tourer EU3	125	09-10	842093	10 060 2560 Cinghia	Mp3	125	07-08	831997	10 060 2110
Beverly	125	01-03	829258	10 060 0990	Sfera	125	95-97	436478	10 060 0420
Carnaby	125	07-09	829258	10 060 0990	Skipper 4T	125	00-02	487401	10 060 0890
Carnaby	125	07-10	842093	10 060 2560 Cinghia	Skipper Lx	125	98-99	480084	10 060 0120
Cosa 2	125	91-97	252971	10 060 0500	Skipper	125	94-97	478240	10 060 0080
Cosa Cl-Clx	125	88-91	252971	10 060 0500	Super Hexagon Gtx 12	125	01-02	487845	10 060 1140
Fly 4T 3V IE E3 DT	125	13-15	8017901	10 060 3030	Typhoon 4T 2V E3	125	10-11	842093	10 060 2560 Cinghia
Fly 4T 3V IE Eu3 Lem	125	12-13	8017901	10 060 3030	Vespa Et4	125	99-02	436478	10 060 0420
Fly EU3	125	07-08	843194	10 060 1160	Vespa Et4	125	99-02	487401	10 060 0890
Fly EU3	125	07-08	832703	10 060 1170 Secondario	Vespa Granturismo EU3	125	06-07	842093	10 060 2560 Cinghia
Fly	125	05-07	843194	10 060 1160	Vespa Granturismo EU3	125	06-07	831997	10 060 2110
Fly	125	05-07	832703	10 060 1170 Secondario	Vespa Granturismo	125	03-05	831997	10 060 2110



FILTRI ARIA - RICERCA PER MARCA

AIR FILTERS - SEARCH BY MODEL

MODELLO - MODEL	Cc	ANNI YEAR	RIF. ORIG. ORIG. REF.	CODICE RMS RMS CODE	MODELLO - MODEL	Cc	ANNI YEAR	RIF. ORIG. ORIG. REF.	CODICE RMS RMS CODE
Vespa Granturismo	125	03-05	842093	10 060 2560 Cinghia	X9	125	01-02	827936	10 060 0880
Vespa Gts 4T Ie Super	125	09-14	831997	10 060 2110	Zip	125	00-02	827634	10 060 0980
Vespa Gts EU3	125	07-12	831997	10 060 2110	Zip	125	00-02	827694	10 060 0900
Vespa Gts EU3	125	07-12	842093	10 060 2560 Cinghia	Cosa 2	150	91-97	252971	10 060 0500
Vespa Gtv 4T Navy EU3	125	08	842093	10 060 2560 Cinghia	Cosa Cl-Clx	150	88-91	252971	10 060 0500
Vespa Gtv 4T Navy EU3	125	08	831997	10 060 2110	Fly EU3	150	08	843194	10 060 1160
Vespa Gtv	125	06-08	842093	10 060 2560 Cinghia	Fly EU3	150	08	832703	10 060 1170 Secondario
Vespa Gtv	125	06-08	831997	10 060 2110	Fly	150	05-07	843194	10 060 1160
Vespa Lx 4T FL	125	09	843194	10 060 1160	Fly	150	05-07	832703	10 060 1170 Secondario
Vespa Lx 4T FL	125	09	832703	10 060 1170 Secondario	Hexagon	150	94-97	434364+434363	10 060 0470 2 Pezzi
Vespa Lx EU3 Ie	125	09-11	843194	10 060 1160	Liberty 4T 3V Lem	125	13-14	B017901	10 060 3030
Vespa Lx EU3	125	06-08	843194	10 060 1160	Liberty 4T EU3	150	08	842093	10 060 2560 Cinghia
Vespa Lx EU3	125	06-08	832703	10 060 1170 Secondario	Liberty 4T EU3	150	08	487287	10 060 0910
Vespa Lx	125	05-06	843194	10 060 1160	Liberty 4T EU3	150	08	832703	10 060 1170 Secondario
Vespa Lx	125	05-06	832703	10 060 1170 Secondario	Liberty 4T Sport EU3	150	08	842093	10 060 2560 Cinghia
Vespa Lx Primavera 4T 3V Ie	125	13-16	B018070	10 060 3040	Liberty 4T Sport EU3	150	08	487287	10 060 0910
Vespa Lxv 4T EU3	125	06-09	843194	10 060 1160	Liberty 4T Sport EU3	150	08	832703	10 060 1170 Secondario
Vespa Lxv 4T EU3	125	06-09	832703	10 060 1170 Secondario	Liberty Moc 4T	150	09	843194	10 060 1160
Vespa Lxv 4T Navy EU3	125	07-08	843194	10 060 1160	Liberty Moc 4T	150	09	832703	10 060 1170 Secondario
Vespa Lxv 4T Navy EU3	125	07-08	832703	10 060 1170 Secondario	Liberty Moc 4T	150	09-10	842093	10 060 2560 Cinghia
Vespa Lx 4T 3V Ie-Touring	125	12-13	B016409	10 060 2820	Liberty	150	01-02	487287	10 060 0910
Vespa S 4T 3V Ie	125	12	B016409	10 060 2820	Skipper 4T	150	00-02	487401	10 060 0890
Vespa Primavera 4T 3V Iget 4T 3V Abs	125	16	B018070	10 060 3040	Skipper	150	94-97	478240	10 060 0080
Vespa Px 30 Anni	125	07-08	486942	10 060 1190 Secondario	Skipper	150	94-97	480084	10 060 0120
Vespa S 4T EU3	125	07-08	843194	10 060 1160	Vespa Et4	150	99-02	487401	10 060 0890
Vespa S 4T EU3	125	07-08	832703	10 060 1170 Secondario	Vespa Gts Super Ie 4T 3V	150	14-15	B018070	10 060 3040
Vespa S 4T Ie	125	09	843194	10 060 1160	Vespa Lt 4T 3V Ie	150	14	B018070	10 060 3040
Vespa Sprint 4T 3V Ie	125	14-15	B018070	10 060 3040	Vespa Lx 4T FL	150	09	843194	10 060 1160
Vespa Sprint Iget 4T 3V Abs	125	16	B018070	10 060 3040	Vespa Lx 4T FL	150	09	832703	10 060 1170 Secondario
X Evo	125	07	831997	10 060 2110	Vespa Lx EU3 Ie	150	09-11	843194	10 060 1160
X7 EU3	125	08	842093	10 060 2560 Cinghia	Vespa Lx EU3	150	06-08	843194	10 060 1160
X7 EU3	125	08	829258	10 060 0990	Vespa Lx EU3	150	06-08	832703	10 060 1170 Secondario
X7 Evo Ie EU3	125	09	829258	10 060 0990	Vespa Lx	150	05-06	843194	10 060 1160
X8 Premium EU2	125	06	831997	10 060 2110	Vespa Lx	150	05-06	832703	10 060 1170 Secondario
X8 Premium EU3	125	06-07	831997	10 060 2110	Vespa Primavera 4T 3V Iget Abs	150	16	B018070	10 060 3040
X8 Street EU2	125	06-07	842093	10 060 2560 Cinghia	Vespa Primavera 4T 3V	150	13-16	B018070	10 060 3040
X8 Street EU2	125	06-07	843194	10 060 1160	Vespa Lx 4T 3V Ie-Touring (fino al 6-2013)	150	12-13	B016409	10 060 2820
X8 Street EU2	125	06-07	832703	10 060 1170 Secondario	Vespa Lx 4T 3V Ie-Touring (dal 6-2013)	150	13	B018070	10 060 3040
X8	125	04-06	831997	10 060 2110	Vespa S 4T Ie	150	09	843194	10 060 1160
X9 Evolution EU3	125	07	831997	10 060 2110	Vespa S 4T	150	08-09	843194	10 060 1160
X9 Evolution	125	03	829258	10 060 0990	Vespa S 4T	150	08-09	832703	10 060 1170 Secondario
X9 Evolution	125	05-06	831997	10 060 2110					

FILTRI ARIA - RICERCA PER MARCA
AIR FILTERS - SEARCH BY MODEL



MODELLO - MODEL	Cc	ANNI YEAR	RIF. ORIG. ORIG. REF.	CODICE RMS RMS CODE	MODELLO - MODEL	Cc	ANNI YEAR	RIF. ORIG. ORIG. REF.	CODICE RMS RMS CODE
Vespa Sprint 4T 3V ie	150	15	B018070	10 060 3040	Beverly Sport	250	06-08	842093	10 060 2560 Cinghia
X8 Street EU2	150	06-08	842093	10 060 2560 Cinghia	Beverly Sport	250	06-08	829258	10 060 0990
X8 Street EU2	150	06-08	843194	10 060 1160	Beverly Tourer EU3	250	06-09	842093	10 060 2560 Cinghia
X8 Street EU2	150	06-08	832703	10 060 1170 Secondario	Beverly Tourer EU3	250	08-09	829258	10 060 0990
Hexagon Gtx 125-180	180	00	487845	10 060 1140	Carnaby	250	08	842093	10 060 2560 Cinghia
Hexagon Lx-Lxt 125-180	180	98-99	434364+434363	10 060 0470 2 Pezzi	Carnaby	250	08	829258	10 060 0990
Super Hexagon Gtx 12	180	01-02	487845	10 060 1140	Mp3 Lt	250	09	842093	10 060 2560 Cinghia
X9 Amalfi	180	00-03	827936	10 060 0880	Mp3 Lt	250	09	831997	10 060 2110
Beverly	200	01-03	829258	10 060 0990	Mp3 Mic	250	08-09	831997	10 060 2110
Carnaby	200	07-08	829258	10 060 0990	Mp3	250	06-08	831997	10 060 2110
Vespa Px	200		285352	10 060 2810	Vespa Gt 60 EU3	250	06-07	842093	10 060 2560 Cinghia
Cosa 2	200	91-97	252971	10 060 0500	Vespa Gt 60 EU3	250	06-07	831997	10 060 2110
Cosa Cl-Clx	200	88-91	252971	10 060 0500	Vespa Gts, Gts Abs	250	05-13	831997	10 060 2110
Liberty 4T EU3	200	07-08	487287	10 060 0910	Vespa Gts, Gts Abs	250	05-13	842093	10 060 2560 Cinghia
Liberty 4T EU3	200	07-08	832703	10 060 1170 Secondario	Vespa Gtv 4T Navy EU3	250	07	842093	10 060 2560 Cinghia
Liberty 4T Sport EU3	200	06-07	487287	10 060 0910	Vespa Gtv 4T Navy EU3	250	07	831997	10 060 2110
Liberty 4T Sport EU3	200	06-07	832703	10 060 1170 Secondario	Vespa Gtv	250	06-09	842093	10 060 2560 Cinghia
Liberty Rst	200	04	487287	10 060 0910	Vespa Gtv	250	06-09	831997	10 060 2110
Liberty Rst	200	04	832703	10 060 1170 Secondario	X7 EU3	250	08	842093	10 060 2560 Cinghia
Liberty Sport	200	06	487287	10 060 0910	X7 EU3	250	08	829258	10 060 0990
Liberty Sport	200	06	832703	10 060 1170 Secondario	X9 Evolution	250	04	829258	10 060 0990
Liberty	200	06	487287	10 060 0910	X9 Evolution	250	04	840476	10 060 1220 Secondario
Liberty	200	06	832703	10 060 1170 Secondario	X9 Evolution	250	06	831997	10 060 2110
Vespa Granturismo	200	06-07	831997	10 060 2110	X9 Evolution	250	06	840476	10 060 1220 Secondario
X8	200	04-07	831997	10 060 2110	X9	250	00-01	496406	10 060 0780
X9 Evolution	200	03	829258	10 060 0990	Xevo	250	07	831997	10 060 2110
X9	200	02-03	829258	10 060 0990	Beverly 300 Ie Tourer	300	09	829258	10 060 0990
Ape Car P2-P3	220	78-85	248570	10 060 0620	Beverly Tourer EU3	300	09-10	842093	10 060 2560 Cinghia
Ape Mp P501-P601	220	78-96	438014	10 060 0620	Carnaby Cruiser	300	09	829258	10 060 0990
Ape Tm P602	220	82-83	248570	10 060 0620	Carnaby Cruiser	300	09-10	842093	10 060 2560 Cinghia
Ape Tm P703-P703V, FI2	220	84-05	438014	10 060 0620	Vespa Gts Ie Touring	300	11-12	842093	10 060 2560 Cinghia
Beverly	250	06-07	842093	10 060 2560 Cinghia	Vespa Gts Super Sport	300	08-14	842093	10 060 2560 Cinghia
Beverly	250	06-07	829258	10 060 0990	Vespa Gts Super	300	08-14	831997	10 060 2110
Beverly	250	06-07	840476	10 060 1220 Secondario	Vespa Gts Super	300	08-14	842093	10 060 2560 Cinghia
Beverly Cruiser	250	07-09	842093	10 060 2560 Cinghia	Vespa Gtv 4T 4V Ie	300	10-13	842093	10 060 2560 Cinghia
Beverly Cruiser	250	07-09	829258	10 060 0990	Vespa Gtv Via Montenap	300	10	842093	10 060 2560 Cinghia
Beverly EU3 Mic	250	07	842093	10 060 2560 Cinghia	X7 Evo Ie EU3	300	09	829258	10 060 0990
Beverly EU3 Mic	250	07	829258	10 060 0990	X7 Evo Ie EU3	300	09-10	842093	10 060 2560 Cinghia
Beverly Ie EU3	250	06-08	842093	10 060 2560 Cinghia	Beverly 4T 4V Ie EU3 Sport Touring	350	11-14	880001	10 060 3050
Beverly Ie EU3	250	06-08	829258	10 060 0990	X10 4T 4V Ie EU3	350	12-13	880001	10 060 3050
Beverly Rst	250	04-05	842093	10 060 2560 Cinghia	Beverly EU3	400	06-07	829258	10 060 0990
Beverly Rst	250	04-05	829258	10 060 0990					
Beverly Rst	250	04-05	840476	10 060 1220 Secondario					



FILTRI ARIA - RICERCA PER MARCA

AIR FILTERS - SEARCH BY MODEL

MODELLO - MODEL	Cc	ANNI YEAR	RIF. ORIG. ORIG. REF.	CODICE RMS RMS CODE	MODELLO - MODEL	Cc	ANNI YEAR	RIF. ORIG. ORIG. REF.	CODICE RMS RMS CODE
Beverly Tourer EU3	400	08-09	829258	10 060 0990	An Burgman L3	650	13	13780-10G00-000	10 060 2720
Mp3 Lt	400	09	829258	10 060 0990	SYM				
Mp3 Mic	400	08-09	829258	10 060 0990	Fiddle II	50	08	17211-AAA-000	10 060 2890
Mp3	400	07-08	829258	10 060 0990	Symply	50	07-08	17211-AAA-000	10 060 2890
X Evo	400	07-09	829258	10 060 0990	Hd Eu2	125	03-04	17211HHA000	10 060 2780
X8 EU3	400	06-08	829258	10 060 0990	Hd Eu3	125	07-08	17211HHA000	10 060 2780
Ape Car- Max Diesel	420	86-96	230414	10 060 0630	Hd Evo Eu3	125	07-11	17211HHA000	10 060 2780
Ape Poker Benzina	420	93	25499	10 060 0640	Hd Evo Tamburo Eu3	125	08-09	17211HHA000	10 060 2780
Ape Poker Diesel	420	93-97	230414	10 060 0630	Hd Evo	125	05-06	17211HHA000	10 060 2780
Ape Tm P703-P703V Diesel	420	87-04	230414	10 060 0630	Hd2	125	11	17211HHA000	10 060 2780
Beverly	500	02-06	829258	10 060 0990	Gts Joymax	125	06-07	17211HLK000	10 060 2690
Beverly Cruiser	500	07-11	829258	10 060 0990	Joyride	125	01-02	17211H6B000	10 060 2680
Beverly EU3	500	06-08	829258	10 060 0990	Joyride Eu2	125	03-06	17211HLK000	10 060 2690
Porter	500		614945	10 060 2600	Joyride Eu3	125	07	17211HLK000	10 060 2690
X9 Evolution Abs	500	06-07	487845	10 060 1140	Joyride Evo	125	09-10	17211HLK000	10 060 2690
X9 Evolution	500	03-07	487845	10 060 1140	Megalo	125	06-07	17211H6B000	10 060 2680
X9	500	01-02	487845	10 060 1140	Attila	150	00-01	17211H6B000	10 060 2680
Porter	1300		1780187Z18000	10 060 2620	Joyride	150	01-02	17211H6B000	10 060 2680
SUZUKI					Joyride Eu2	200	03-06	17211H6B000	10 060 2680
Ah Address	50	92-95	13780-4OD40-000	10 060 0050	Hd Eu2	200	03-04	17211HHA000	10 060 2780
Ay A'Yw Katana V-Y	50	97-00	13782-35E00-000	10 060 0840 2 Pezzi	Hd Eu3 I	200	07	17211HHA000	10 060 2780
Ay Ayw K1-K4	50	01-04	13782-35E00-000	10 060 0840 2 Pezzi	Hd Evo Eu2	200	05-06	17211HHA000	10 060 2780
Uf Estilete	50	00	13782-35E00-000	10 060 0840 2 Pezzi	Hd Evo Eu3 I	200	07	17211HHA000	10 060 2780
Ux Zillion	50	99	13782-35E00-000	10 060 0840 2 Pezzi	Hd Evo I Eu3	200	10-12	17211HHA000	10 060 2780
Uh Burgman K2-K6	125	02-06	13780-49F00-000	10 060 1230	Hd Evo I Tamburo Eu3	200	08-09	17211HHA000	10 060 2780
Uh Burgman K7-L0	125	07-10	13780-03H00-000	10 060 2550	Hd2 I	200	11	17211HHA000	10 060 2780
Uh Burgman	125	11-14	13782-03H00-000	10 060 2520	Joymax EU3	250	07	17211HMA000	10 060 2570
Uh Burgman	125	11-14	13780-03H00-000	10 060 2550	Joymax	250	05-07	17211HMA000	10 060 2570
Ux Sixteen	125	08-11	13780-20H00-000	10 060 2540	Gts	250	07-08	17211HMA000	10 060 2570
Ux Sixteen	125	11	13785-20H00-000	10 060 2530	Joymax Evo	300	10	17211HMA000	10 060 2570
Ux Sixteen	150	08-11	13780-20H00-000	10 060 2540	Citycom	300	10	17211LEA000	10 060 2730
Ux Sixteen	150	11	13785-20H00-000	10 060 2530	YAMAHA				
Uh Burgman K2-K6	150	02-06	13780-49F00-000	10 060 1230	Bw'S	50	04-10	3VLE44510100	10 060 0310
Uh Burgman K7-L0	200	07-10	13780-03H00-000	10 060 2550	Bw'S Naked	50	03-04	3VLE44510100	10 060 0310
Uh Burgman	200	11-14	13782-03H00-000	10 060 2520	Bw'S Naked	50	09	3VLE44510100	10 060 0310
Uh Burgman	200	11-14	13780-03H00-000	10 060 2550	Bw'S Next Generation	50	97-06	3VLE44510100	10 060 0310
An Burgman K3-K6	250	03-06	1378-14F01-000	10 060 0940	Bw'S Next Generation Cat.	50	99-00	3VLE44510100	10 060 0310
An Burgman W-K2	250	98-02	1378-14F01-000	10 060 0940	Bw'S Original	50	97-02	3VLE44510100	10 060 0310
An Burgman K3-K6	400	03-06	1378-14F01-000	10 060 0940	Bw'S Original EU2	50	03	3VLE44510100	10 060 0310
An Burgman X-K2	400	99-02	1378-14F01-000	10 060 0940	Bw'S R	50	01	3VLE44510100	10 060 0310
An Burgman K7-L0	400	07-10	13781-05H00-000	10 060 2610	Cw L Bw'S	50	03-04	3VLE44510100	10 060 0310
An Burgman L1	400	11	13781-05H00-000	10 060 2610	Cw Rs Spy	50	95-98	3VLE44510100	10 060 0310
An Burgman L2	400	12	13781-05H00-000	10 060 2610	Cw Sp Bw'S Original EU2	50	02	3VLE44510100	10 060 0310
An Burgman L3	400	13	13781-05H00-000	10 060 2610	Ew Slider	50	00-02	3VLE44510100	10 060 0310
An Burgman K3-K5	650	03-05	13780-10G00-000	10 060 2720	Yh Why	50	98	5EUE44510000	10 060 0350
An Burgman K6-L0	650	06-10	13780-10G00-000	10 060 2720	Yh Why	50	01-02	5EUE44510000	10 060 0350
An Burgman L1	650	11	13780-10G00-000	10 060 2720	Yh Why	50	06	5EUE44510000	10 060 0350
An Burgman L2	650	12	13780-10G00-000	10 060 2720	Yh Why Euro1	50	99-00	5EUE44510000	10 060 0350
					Yh Why EU2	50	03-05	5EUE44510000	10 060 0350
					Ym Breeze	50	94-95	3KJ144510000	10 060 0060
					Yn F Neo's 4	50	09-13	5C3E4451000	10 060 2790

FILTRI ARIA - RICERCA PER MARCA

AIR FILTERS - SEARCH BY MODEL



MODELLO - MODEL	Cc	ANNI YEAR	RIF. ORIG. ORIG. REF.	CODICE RMS RMS CODE	MODELLO - MODEL	Cc	ANNI YEAR	RIF. ORIG. ORIG. REF.	CODICE RMS RMS CODE
N-Max	125	15	2DPE44510000	10 060 2990	Yp R X-Max Sport	250	11-12	37PE44510000	10 060 2410 Aspirazione
Nxc Cygnus X	125	04-11	5TYE4451100	10 060 2740	Yp R X-Max	250	10-14	37PE44510000	10 060 2410 Aspirazione
Vp X-City	125	08-11	1B9144510000	10 060 2410 Aspirazione	Yp Ra X-Max Abs	250	11-14	37PE44510000	10 060 2410 Aspirazione
Yp R X-Max Abs	125	11	1B9144510000	10 060 2410 Aspirazione	Vp X-City	250	07-12	1B9144510000	10 060 2410 Aspirazione
Yp R X-Max	125	06-12	1B9144510000	10 060 2410 Aspirazione	Yp R Black X-Max	250	09	1B9144510000	10 060 2410 Aspirazione
Yp R X-Max	125	10-14	37PE44510000	10 060 2410 Aspirazione	Yp R X-Max Sport	250	11-12	1B9144510000	10 060 2410 Aspirazione
Yp Ra X-Max Abs	125	13-14	37PE44510000	10 060 2410 Aspirazione	Yp R X-Max	250	05-12	1B9144510000	10 060 2410 Aspirazione
Vpx-City	125	08	5DS154070100	10 060 0710 Variatore	Yp Ra X-Max Abs	250	11-12	1B9144510000	10 060 2410 Aspirazione
Xc Cygnus R	125	99	4CWE44510200	10 060 0800	Vp X-City	250	07-13	5GM154070000	10 060 2420
Xc Cygnus R	125	99-03	4CWE54071000	10 060 2010 Variatore	Yp Majesty	250	00-03	5GM154070000	10 060 2420 Variatore
Xc K Cygnus R	125	97-98	4CWE44510200	10 060 0800	Yp Majesty	250	96-98	4HC144510000	10 060 0330
Xc K Cygnus R	125	97-98	4CWE54071000	10 060 2010 Variatore	Yp Majesty	250	00-03	4HC144510000	10 060 0330
Xc T Cygnus	125	95-98	4CWE44510200	10 060 0800	Yp Majesty	250	96-98	4HC15407-0000	10 060 2000 Variatore
Xc T Cygnus	125	97-98	4CWE54071000	10 060 2010 Variatore	Yp Majesty	250	00-03	5GM154070000	10 060 2420
Xn Teo'S	125	00	5DS154070100	10 060 0870 Variatore	Yp Majesty Abs	250	03	5GM154070000	10 060 2420 Variatore
Xq Maxster	125	01-02	5DSE44510000	10 060 0790 Variatore	Yp Majesty Abs	250	03	4HC144510000	10 060 0330
Xq Maxster	125	01-02	5DS154070100	10 060 0870 Variatore	Yp Majesty Dx	250	98-99	4HC144510000	10 060 0330
Xenter	125	12>	52SE445100	10 060 2860	Yp Majesty Dx	250	98-99	4HC15407-0000	10 060 2000 Variatore
Xenter	125	12>	52SE54080000	10 060 2870 Carter	Yp Majesty Abs	250	07-13	5GM154070000	10 060 2420
Yp E Majesty	125	03-09	5DSE44510000	10 060 0790 Variatore	Yp R Black X-Max	250	09	5GM154070000	10 060 2420 Variatore
Yp E Majesty	125	03-09	5DS154070100	10 060 0870 Variatore	Yp R Black X-Max	250	09	1B9144510000	10 060 2410 Aspirazione
Yp Majesty	125	98-02	5DSE44510000	10 060 0790 Variatore	Yp R Black X-Max	250	09	5GM154070000	10 060 2420
Yp Majesty	125	98-02	5DS154070100	10 060 0870 Variatore	Yp R X-Max	250	05-10	5GM154070000	10 060 2420 Variatore
Yp R X-Max	125	07-09	5DS154070100	10 060 0710 Variatore	Yp R X-Max	250	05-14	1B9144510000 37PE44510000	10 060 2410 Aspirazione
Yp R X-Max	125	06	5DS154070100	10 060 0710 Variatore	Yp R X-Max	250	05-14	5GM154070000	10 060 2420
Yn Bw's	125	10	5S9E44510000	10 060 2930	Yp Ra X-Max Abs	250	11-14	5GM154070000	10 060 2420
Xn Teos	150	01-02	5DS154070100	10 060 0870 Variatore	Yp R X-Max Sport	250	11-12	5GM154070000	10 060 2420
Xq Maxster	150	01-02	5DSE44510000	10 060 0790 Variatore	Xc Versity	300	03-06	5GM154070000	10 060 2420 Variatore
Xq Maxster	150	01-02	5DS154070100	10 060 0870 Variatore	Xc Versity	300	03-06	5SEE44510000	10 060 0850
Xenter	150	12>	52SE445100	10 060 2860	Xc Versity	300	03-06	5GM154070000	10 060 2420
Xenter	150	12>	52SE54080000	10 060 2870 Carter	Yp Majesty	400	04-09	5RU144512000	10 060 2330 Sinistro
Yp Majesty	150	00-02	5DSE44510000	10 060 0790 Variatore	Yp Majesty	400	04-09	5RU144612000	10 060 2340 Destro
Yp Majesty	150	01-02	5DS154070100	10 060 0870 Variatore	Yp Majesty	400	04-11	5RU154070200	10 060 2350 Variatore
Yp E Majesty	180	03-06	5DSE44510000	10 060 0790 Variatore	Yp Majesty Abs	400	07-09	5RU144512000	10 060 2330 Sinistro
Yp E Majesty	180	03-06	5DS154070100	10 060 0870 Variatore	Yp Majesty Abs	400	07-09	5RU144612000	10 060 2340 Destro
Vp X-City	250	07-10	5GM154070000	10 060 2420 Variatore	Yp Majesty Abs	400	07-11	5RU154070200	10 060 2350 Variatore
Vp X-City	250	09-13	37PE44510000	10 060 2410 Aspirazione	Yp X-Max	400	13-14	1SDE44610000	10 060 2340 Destro
					Yp Ra X-Max Abs	400	14	1SDE44610000	10 060 2340 Destro



FILTRI ARIA - RICERCA PER MARCA

AIR FILTERS - SEARCH BY MODEL

MODELLO - MODEL	Cc	ANNI YEAR	RIF. ORIG. ORIG. REF.	CODICE RMS RMS CODE
Yp X-Max	400	13-14	11SDE44510000	10 060 2330 Sinistro
Yp Ra X-Max Abs	400	13-14	11SDE44510000	10 060 2330 Sinistro
Yp X - Max	400	13	5RU154070200	10 060 2350 Variatore
Yp Ra X - Max Abs	400	14	5RU154070200	10 060 2350 Variatore
Xp T-Max Abs Sv	500	11	4B5154070000	10 060 2490
Xpt-Max	500	08-11	4B5154070000	10 060 2490
Xpt-Max	500	01-08	4BH144510100	10 060 2200 Aspirazione
Xpt-Max	500	01-07	5GJ154070100	10 060 2360
Xpt-Max	500	01-10	5GJ154060000	10 060 2370 Puleggia
Xpt-Max	500	06	5GJ154070100	10 060 2360
Xpt-Max	500	08-10	4B5144510000	10 060 2440 Aspirazione
Xpt-Max Abs	500	08-11	4B5154070000	10 060 2490
Xpt-Max Abs	500	05-07	4BH144510100	10 060 2200 Aspirazione
Xpt-Max Abs	500	05-07	5GJ154070100	10 060 2360
Xpt-Max Abs	500	05-10	5GJ154060000	10 060 2370 Puleggia
Xpt-Max Abs	500	08	4B5144510000	10 060 2440 Aspirazione
Xpt-Max Black Max	500	06	4BH144510100	10 060 2200 Aspirazione
Xpt-Max Black Max	500	06	5GJ154070100	10 060 2360
Xpt-Max Black Max	500	06	5GJ154060000	10 060 2370 Puleggia
Xpt-Max Black Max- Night Max	500	07	4BH144510100	10 060 2200 Aspirazione
Xpt-Max Black Max- Night Max	500	07	5GJ154070100	10 060 2360
Xpt-Max Black Max- Night Max	500	07	5GJ154060000	10 060 2370 Puleggia
Xpt-Max White Max	500	08	4B5154070000	10 060 2490
Xpt-Max White Max	500	10	5GJ154060000	10 060 2370 Puleggia
Xpt-Max White Max	500	10	4B5144510000	10 060 2440 Aspirazione
Xp T-Max	500	11	4B5154070000	10 060 2490
Xp T-Max Abs - Xp T-Max	530	12	4B5144510000	10 060 2440 Aspirazione
Xp T-Max Abs - Xp T-Max	530	12	59C-15408-00	10 060 2710 Puleggia
Xp T-Max Abs	530	12-13	59C154070000	10 060 2880 Carter
Xp T-Max	530	12-13	59C154070000	10 060 2880 Carter
Gts	1100	93	4BH144510100	10 060 2200 Aspirazione
Gts A (Abs)	1100	93	4BH144510100	10 060 2200 Aspirazione

ADIVA

10 060 2685

125-200: Ad 09-11 • Ar 09-11
(Riferimento Champion: CAF4101)



APRILIA

10 060 4595

(Riferimento Champion: V300)

10 060 5105

(Riferimento Champion: CAF5102)
650: Pegaso 93-99
660: Pegaso Street / Trail / Factory 05-12



10 060 0045

125: Leonardo / St 96-05
150: Leonardo / St 96-05
(Riferimento Champion: Y318)



BMW

10 060 5035

450: Rxv 06-14 • Sxv 06-14
550: Rxv 06-14 • Sxv 06-14
1000: Rsv R Tuono Factory 05-10 • Rsv4 09-14
• Rsv4 Tuono 11-14
(Riferimento Champion: CAF5101)



10 060 2265

650: F Gs 00-04 • F Gs 05-07 • F Gs Dakar 01-04
• F Gs Dakar 05-07 • G Gs 09-13
(Riferimento Champion: CAF6601)



10 060 4065

650: F Cs 02-05 • G Xchallenge 07-08 • G
Xcountry 07-08 • G Xmoto 07-08
(Riferimento Champion: CAF6602)



10 060 4075

850: R GS Boxer 99 • R R 00-06 • R R Boxer 99 •
R R Classic 02-04 • R RT 99
1100: R GS 93-99 • R R 95-01 • R RS 93-01 • R RS
Special Ed. 00 • R RT 99-01
1150: R GS 99-05 • R GS Adventure 02-03 • R
GS Adventure 04-05 •
R R 01-06 •
R R Rockster 04-05 • R
R Rockster Ed. 80 04 •
R RS 02-05 • R RS SE
02-05 • R RT 02-05
(Riferimento
Champion: CAF6910)



10 060 4085

1100: R S 99-05
(Riferimento Champion: CAF6911)



10 060 4095

1200: R Gs 04-09 • R Hp2 Enduro 05-08 • R Hp2
Megamoto 07-08 • R Hp2 Sport 08-09 • R R 07-
10 • R Rt 05-09 • R S 06-09 • R St 05-08
(Riferimento Champion: CAF6912)



10 060 4105

650: F Gs 08-11
800: F Gs 07-11
(Riferimento Champion: CAF6913)



10 060 4115

1200: R Gs 10-12 • R Gs Adventure 10-13
R Gs Adventure Triple Black 12 • R Gs Rallye 12
R Gs Triple Black 12 • R R 11-13 • R R Classic 12
R RT 10-13 • R
Rt SE 10-12
(Riferimento
Champion:
CAF6914)



10 060 4735

650: F FL, St 94-98
(Riferimento Champion: Y316)



BMW

10 060 5055



600: C Sport 12-15
650: C Gt 12-15
(Riferimento Champion: CAF6604)



10 060 5065



1300: K Gt 09-10 • K Gt Se 10 • K R 09-13 • K R Carbon 12 • K R Dynamic 12 • K S (2 pcs) 09-15 • K S Hp (2 pcs) 12 • K S Sport (2 pcs) 12
(Riferimento Champion: CAF6917)



10 060 5075



1600: K Gt 11-15 • K Gt Se 12 • K GtL 11-15 • K GtL Exclusive 13-15 • K GtL Se 12
(Riferimento Champion: CAF6916)



CAGIVA

10 060 5085



1000: S R 13-15 • S Rr 10-15 • S Rr Sport 10
(Riferimento Champion: CAF6918)



10 060 4815

650: Raptor I.e. 00-05 • V-Raptor 01-04
(Riferimento Champion: Y334)



DUCATI

10 060 2295

(Riferimento Champion: U301)

10 060 5095



(Riferimento Champion: CAF5002)

350: Supersport Jr
400: Monster • Ss Junior Super Sport 92-94 • Supersport 93-97
600: Monster 93-01 • Monster Chromo / Dark 93 • Ss 93-98
620: Monster Dark 06 • Monster Dark I.e. 04-05 • Sport 03
650: Indiana Custom 86-88 • Pantha SL 86-88
695: Monster 07-08
750: Monster 96-01 • Monster I.e. 02 • Sport 01-02 • Sport 01 • Ss 91-02 • Supersport (Usa) I.e. 91 • Supersport Ie 02
800: Sport 03 • Ss 03-07
851: Strada 89-92
888: Sp5 93 • Superbike (Usa) 94-95 • Superbike Strada 94-95
900: Monster 93-01 • Monster I.e. / Dark 02 • Sport 02 • Super Light 92-97 • Super Sport 90-02 • Supersport Superlight Usa, CR Usa, FE, I 91
907: I.e. Usa 91-92 • I.e. 90-93
916: St4 99-03
944: St2 97-03
992: St3 04-07 • St3 S (Abs) (Usa) 07
996: Sport Touring 4S 01
1000: Ss 03-05 • Ss Usa 03 • St3 Usa 04



MOTO GUZZI

10 060 2275

650: 65Gt 88-89 • Ntx 86-90 • V65 83-95
750: V75 Strada-Targa-Sp-Nevada 90-02
850: Griso 06-11 • Le Mans I,II,III 75-83 • Norge 06-11 • T3 California 75-83 • T4,T5 75-88 • T5 89-05
1000: California II 82-86 • California III 87-93 • California III le 90-93 • Le Mans IV 84-87 • Le Mans V 86-92 • Mille Gt 87-94 • S 90-93 • Sp 78-83 • Sp2 84-87 • Sp3 88-96
(Riferimento Champion: U300)



10 060 5115

940: Bellagio 07-12
1000: Daytona 93-01 • V10 Centauro 97-01
1100: California 94-12 • California Ev 98-05 • Sport 94-95 • Sport ie 96-00 • V11 98-05
(Riferimento Champion: CAF5401)



10 060 5035

850: Griso 06-11
1100: Griso 05-08
1200: Griso 8V 07-14 • Griso 8V Se 10-14 • Stelvio 08-14 • Stelvio Ntx 10-14
(Riferimento Champion: CAF5101)



HONDA

10 060 1135

125: @ 00-02
125-150: Nes Chiocciola 00-07 • Psi 06-11 • Ses Dylan 02-07 • Sh 01-08 • Sh i 09-12 • Sh i Sporty 11 • Sh ie Dd - Sporty 09-10
(Riferimento Champion: CAF0112)



10 060 4005

125: Cbr R 04-12
(Riferimento Champion: CAF0113)



10 060 2635

400: Silver Wing (Fjs) 06-09 • Sw-T (Fjs) 09-12
600: Silver Wing (Abs) (Fjs) 03-11 • Silver Wing (Fjs) 01-04 • Sw-T (Fjs) 11-12
(Riferimento Champion: CAF0617)



10 060 4135

500: Cb Cup 99 • Cb 94-02 • Cb S 98-02
(Riferimento Champion: J301)



10 060 4185

750: Cb C Custom 80-82 • Cb Custom • Cb F Bol D'or • Cb F 80-85 • Cb 79-82
900: Cb Bol D'Or 79-82 • Cb C Custom 80-82 • Cb F Supersport 79-82 • Cb 83-84 • Cb F 79-82
1000: Cb C Custom 83
1100: Cb F 83 • Cb 81 • Cb 82-83
(Riferimento Champion: J306)



10 060 4195

600: XLV Transalp 87-00
650: Xrv Africa Twin 88-90
750: Xrv Africa Twin 90-92
(Riferimento Champion: J307)



10 060 4205

600: Cbr Hurricane 91-94
(Riferimento Champion: J308)



10 060 4265

750: Xrv Africa Twin 93-02
(Riferimento Champion: J314)



10 060 4275

900: Cbr Rr Fire Blade 92-95 • Cbr Fire Blade 96-99
(Riferimento Champion: J315)



HONDA

10 060 4285

1000: Cbr F Hurricane 87-95 • Cbr 87-88 • Cbr 89-92 • Cbr 93-94 • Cbr 95-99
(Riferimento Champion: J316)



10 060 4295

750: Cb F 92-00 • Cb Nighthawk 750 91-03 • Cb Seven Fifty 01-02 • Cbx F 84-86
(Riferimento Champion: J317)



10 060 4365

400: Nt Bro's
600: Ntv 88-92
650: Nt Hawk Gt 88-91 • Ntv Bro's 88-91 • Ntv Revere 93-97
(Riferimento Champion: J324)



10 060 4385

400: Cbr Aero • Cbr Rrh
600: Cbr 87-88 • Cbr 89-90
(Riferimento Champion: J326)



10 060 4405

400: Nv Custom
600: Vt C Shadow VLX 88-93 • Vt Shadow VLX 95-98 • Vt Shadow VLX 93-95
(Riferimento Champion: J328)



10 060 4495

1500: Gold Wing Aspencade 91-00 • Black Widow 01 • Gold Wing 88-93 • Gold Wing Interstate 91-96 • Gold Wing 90-01
(Riferimento Champion: J338)



10 060 4505

1100: Cbr Xx Black Bird 97-98
(Riferimento Champion: J339)



10 060 4515

1100: Cb S X-Eleven 00-03 • Cbr Xx Black Bird 99-06
(Riferimento Champion: J340)



10 060 4525

650: Ntv Deauville 98-05
(Riferimento Champion: J341)



10 060 4535

1000: Vtr F Fire Storm 97-02 • Vtr F Fire Storm 03-05 • Vtr F Super Hawk 98-02 • Vtr F Super Hawk 03-05 • XLV Varadero 99-02
(Riferimento Champion: J342)



10 060 4545

600: Cbr F 99-00
(Riferimento Champion: J343)



10 060 4555

650: XLV Transalp 01-07
(Riferimento Champion: J345)



HONDA

10 060 4565

800: Vfr F1 Interceptor 02-03 • Vfr F1 V-TEC Interceptor (Abs) 02-09 • Vfr F1 V-TEC Interceptor 04-09 • Vfr F1 Interceptor 98-99 • Vfr F1 Interceptor (Cbs & Pgm) 00-01
(Riferimento Champion: J346)



10 060 4675

650: Nx Dominator 01-02 • Nx Dominator 88-94 • Nx Dominator 95-00
(Riferimento Champion: V312)



10 060 4865

1200: Gold Wing Aspencade 84-87 • GL 84-88 • Gold Wing 84-87 • Gold Wing Interstate 84-87
(Riferimento Champion: Y339)



10 060 4875

1100: Vt C Shadow 87-88 • Vt C Shadow 89-95 • Vt C Shadow Spirit 99-07 • Vt Shadow 95-98 • Vt Shadow Sabre 99-07 • Vt Shadow Aero 98-02 • Vt Shadow American Classic Ed. 98 • Vt Shadow 99 • Vt Shadow Ace Tour 98-02
(Riferimento Champion: Y340)



10 060 4885

500: Cbf 04-08 • Cbf Abs 04-08
600: Cb F Hornet 03-06 • Cb F Hornet 98-02 • Cb S Hornet 00-02 • Cb S Hornet 03 • Cbf N 04-07 • Cbf S Abs 04-07
(Riferimento Champion: Y341)



10 060 4905

100: Scv Lead 03-07
(Riferimento Champion: CAF0116)



10 060 4915

110: Nhx Lead 08-11
(Riferimento Champion: CAF0117)



10 060 2655

125-150: Fes Pantheon 4T 03-07 • Fes S Wing 07-12
(Riferimento Champion: CAF0118)



10 060 2775

125: Pcx 13-14
150: Pcx 12-13
(Riferimento Champion: CAF0120)



10 060 2855

125-150: Sh 13-14
(Riferimento Champion: CAF0121)



10 060 2665

125: Pcx 11-12
(Riferimento Champion CAF0114)



10 060 2645

250: Nss Forza X / Ex 05-07
(Riferimento Champion: CAF0213)



HONDA

10 060 2385

300: Sh I Abs 07-13 • Sh I Sport Abs 08-13
(Riferimento Champion CAF0304)



10 060 5125

670: Nm4 Vultus 15-16
700: Nc S-Jd-X-Xd DCT 12-15 • Ctx N-DCT 14-16 • Integra DCT
750: Integra DCT 14-15 • Nc S-X DCT 14-15
(Riferimento Champion CAF0715)



ITALJET

10 060 2425

250: Jupiter 01-03
(Riferimento Champion: CAF3203)



KAWASAKI

10 060 4015

1000: KlV 04-06
(Riferimento Champion: CAF2611)



10 060 4725

600: Zx6-R Ninja 95-97
(Riferimento Champion: Y310)



10 060 4475

900: Zx-9R Ninja 98-99 • Zx-9R Ninja 00-01 • Zx-9R Ninja 02-03
(Riferimento Champion: J336)



10 060 4355

750: Gpz R 85-88
900: ZL Eliminator 85-86 • Gpz R Ninja 84-96
1000: Zg Concours (Gtr) 86-06 • ZL Eliminator 87-88
(Riferimento Champion: J323)



10 060 4465

400: Gpz S 89-90
500: Gpz S 87-89 • Gpz S 90-93 • Gpz S 03 • Ex Ninja R 04-06 • Gpz S 94-96 • Gpz S 97-02 • Ex Ninja R 07-09
(Riferimento Champion: J335)

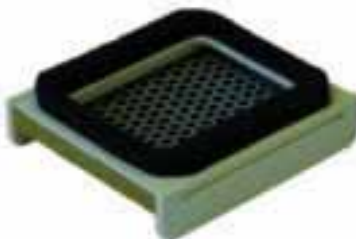

10 060 4175

400: Zr Zephyr 89-93 • Gpz r 85-86
550: Gt 87-01 • Zr Zephyr 91-00 • Zx Unitrack Gpz 87-92
750: Zr Zephyr 91-95 • Zr Zephyr 96-99 • Zr-75 01-03 • Zr-7 99-03
(Riferimento Champion: J305)



10 060 4845

1100: Zrx Zephyr 96-00
1200: Zrx 01-03 • Zrx R 01-06 • Zrx S 01-04
(Riferimento Champion: Y337)



10 060 4855

1500: Vn Classic 96-98 • Vn Classic 99-04 • Vn Classic Tourer 98 • Vn Nomad 99-01 • Vn Drifter 99-00 • Vn Nomad Fi 00 • Vn Classic Tourer Fi 99-00 • Vn Nomad Fi 01 • Vn Classic Tourer Fi 01-03 • Vn Nomad Fi 02-04 • Vn Classic Fi 00-02 • Vn Classic 05-06 • Vn Classic 07-08 • Vn Mean Streak 02-03 • Vn Drifter 01-05
1600: Vn Mean Streak 04-06 • Vn Mean Streak 07-08
(Riferimento Champion: Y338)



10 060 4325

400: Z (4 Cyl) (Kz j) 80-83 • Zx 84-87
500: Z 79-80 • Z (6 Speed) 81
550: Kz 80-83 • Kz 82-84 • Z 80-83 • Z 79-80 • Z Ltd 81-83 • Z Twin Shock (Gpz) 81 • Z (Gt) 83-86 • Z Unitrack (Gpz) 84-86
600: Zx (Gpz R) 85-89
(Riferimento Champion: J320)



KAWASAKI

10 060 4485

600: Zx6-R Ninja 98-99 • Zx6-R Ninja 00-01
• Zx6-R Ninja 02 • Zzr 05-06 • Zzr 07-08
636: Zx6-R Ninja 02
(Riferimento Champion: J337)



10 060 4715

250: EL B/F 96-03 • EL Eliminator 88-96
500: Kle 91-02
600: Gpx R 88-00
750: Gpx R 86-88
(Riferimento
Champion: Y308)



10 060 4895

500: Er-5 96-06
(Riferimento Champion: Y342)

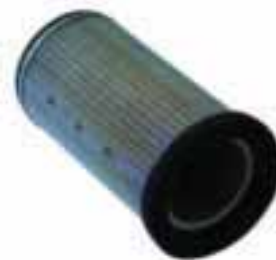

10 060 5135

650: Er-6f 13-14 • Er-6n 13-14 • Ex Ninja R (ABS)
13-16
(Riferimento Champion: CAF1608)



10 060 5145

1000: Zx-10R Ninja (ABS) 11-15
(Riferimento Champion: CAF1918)



KTM

10 060 5045

1050: Adventure 15
1190: Adventure 13-15 • Adventure R 13-15
1290: Super Adventure 14 • Super Duke R 14
(Riferimento Champion: CAF5301)



10 060 5185

125-200-390: Duke 11-16 • RC 14-16
(Riferimento Champion: CAF5302)



KYMCO

10 060 2315

125: Agility City (16") 08-12 • Ciak 01-09 •
People 99-12 • People S 05-12 •
People S Dd le 07-12 • Super 8 08-12
150: Agility City (16") 08-10 • Ciak 01-05 •
People 99-12 • People S 05-12 • People S DD
i.e. 07-12 • Super 8 10-12
200: Ciak Master 06-09 • i People S 05-12
• i People S le 07-12
(Riferimento Champion: CAF4001)



10 060 9345

125: Agility (12") 06-07 • Agility (12") 08-11 •
Agility RS (12") 09-11 • Movie XL 01-05
• Movie XL 06-10
150: Movie XL 01-05 • Movie XL 06-09
(Riferimento Champion: CAF4002)



10 060 2585

125-200: Downtown 09-13
(Riferimento Champion: CAF4004)



KYMCO

10 060 4945

500: X Citing / i / ir 04-13
(Riferimento Champion: CAF4005)



10 060 2435

250: People 03-05 • People S 05-08 • People S le 07-11
300: People S i 08-12
(Riferimento Champion: CAF4006)



10 060 4955

125: Agility 4T R12 / Carry / Rs 05-13
(Riferimento Champion: CAF4007)



MALAGUTI

10 060 0745

125: Dink ie 06-13 • Gran Dink 01-11 • Gran Dink S 08-11 • Gran Dink ie 12-13
150: Gran Dink 01-11
200: Dink ie 06-13
250: Gran Dink 01-09 • Xciting 05-08
300: Xciting Ri 08-12
(Riferimento Champion CAF4003)



10 060 2425

250: Password 05-09
(Riferimento Champion: CAF3203)



MBK

10 060 2425

250: Skyliner 00-03
300: Kilibre 03
(Riferimento Champion: CAF3203)



10 060 2915

125: Citycruiser 07-11 • Cityliner 07-13 • Skycruiser 06-13
(Riferimento Champion CAF3104)



PIAGGIO

10 060 0425

125: Sfera 95-97 • Vespa Et4 96-99
(Riferimento Champion: Y309)



PEUGEOT

10 060 2685

50-125-150: Tweet 10-13 • Tweet Rs 4T 10-13
(Riferimento Champion: CAF4101)



10 060 4975

125-200: Lxr 09-12
(Riferimento Champion: CAF4104)



SYM

10 060 2685

50: Symphony 4T / S 09-13
125: Symphony 4T / S 09-13 • Hd2 11-13
• Joyride 01-02 • Megalo 06-08 • Rv 01-03
150: Symphony 4T / S 09-13 • Hd2 11-13
• Joyride 01-02 • Rv 01-03
180: Rv 01-03
200: Joyride 03
(Riferimento Champion: CAF4101)



10 060 2695

125: Joyride E2 03-08 • Joyride E3 07-12
• Joyride Evo E3 09-13
(Riferimento Champion: CAF4102)



10 060 4965

125-150: Vs E3 06-12
(Riferimento Champion: CAF4103)



10 060 4975

125-200: Hd / Evo / Evo E3 07-13
(Riferimento Champion: CAF4104)



10 060 2735

300: Citycom 07-12
(Riferimento Champion: CAF4105)



SUZUKI

10 060 2555

125: Burgman 07-12
200: Burgman 07-12
(Riferimento Champion: CAF2103)



10 060 4015

650: DL V-Strom 04-06
1000: DL V-Strom 02-10 • DL Se V-Strom 10
(Riferimento Champion: CAF2611)



10 060 4025

600: Gsr B Yoshimura 10 • Gsr 06-10
750: Gsr 11-12
(Riferimento Champion: CAF2613)



10 060 4035

600: Gsx-R 04-05
750: Gsx-R 04-05
(Riferimento Champion: CAF2616)



10 060 4045

600: Gsx-R 06-10
750: Gsx-R 06-10
(Riferimento Champion: CAF2617)



10 060 4155

500: Gs E 96 • Gs E (2 Cylinders) 88-02 • Gs F 04-10
• Gs H 07-09 • Gs 03-06
700: Gv 85
1200: Gsx Inazuma 99-00 • Gv 85-86
(Riferimento Champion: J303)



SUZUKI

10 060 4165



600: Gsf Bandit 95-99 • Gsf Bandit 96-99 • Gsx-R 92-93
750: Gsx-R 92-95
1100: Gsx-R 92-97
1200: Gsf S Bandit 97-99 • Gsf Bandit 96-99
(Riferimento Champion: J304)



10 060 4335



750: Gsx-R Sling Shot 88-89 • Gsx-R Sling Shot 90-91
1100: Gsx-R 89-92
(Riferimento Champion: J321)



10 060 4345



600: Gsx F 88-89
1100: Gsx F 88-96
(Riferimento Champion: J322)



10 060 4375



600: Rf 93-97
900: Rf 94-00
(Riferimento Champion: J325)



10 060 4435



1000: TL R 98-02
(Riferimento Champion: J332)



10 060 4445



600: Gsf Bandit 00-04 • Gsf S Bandit 00-04
1200: Gsf Bandit 00-04 • Gsf S Bandit 00-04
(Riferimento Champion: J333)



10 060 4455



600: Gsx-R 01-03
750: Gsx-R 00-03
1000: Gsx R 93-00 • Gsx-R 01
(Riferimento Champion: J334)



10 060 4585



650: Ls Savage (Belt) 05-09 • Ls Savage (Belt) 01-04 • Ls Savage (Belt) 91-00 • S40 Boulevard (Ls) 05-11
(Riferimento Champion: U308)



10 060 4635



750: Gs 79-81 • Gs Sd 83 • Gsx 79-81 • Gsx S-Ss 84-85 • Gsx 84-85 • Gsx 80-82
1000: Gs 78-80 • Gs 78-80 • Gs 79-83
1100: Gs E 80-83 • Gs 80-83 • Gs 80-81 • Gs 83 • Gsx 80-82
(Riferimento Champion: V307)



10 060 4655



600: Vs 98 • Vs 95-97
700: Vs 86 • Vs 87-88 • Vs 88
750: Vs Intruder 90-98 • Vs 85-86 • Vs Intruder 87 • S50 Boulevard 05-09
800: Vs Intruder (S50 Intruder) 92-09
(Riferimento Champion: V310)



10 060 4685



400: Gsf Bandit 90-95
(Riferimento Champion: Y302)



10 060 4695



650: Dr 90-96
(Riferimento Champion: Y304)



SUZUKI

10 060 4745

1400: Vs Intruder S83 05-09 • Vs 87-96
• Vs Intruder 97-04
(Riferimento Champion: Y320)



10 060 4815

650: Sv 99-02
(Riferimento Champion: Y334)



10 060 4825

600: Gsx-R 97-00
750: Gsx-R Srad 96-99
(Riferimento Champion: Y335)



10 060 4835

600: Gsx F 90-00 • Gsx F 01-06
750: Gsx F 89-06
(Riferimento Champion: Y336)



10 060 2545

125-150: Sixteen 07-13
(Riferimento Champion: CAF2104)



10 060 2615

400: Burgman 06-13
(Riferimento Champion: CAF2401)



10 060 2725

650: Burgman 02-13
(Riferimento Champion: CAF2619)



10 060 5155

600: Gsx-R 11-15
750: Gsx-R 11-15 • Gsx-R Z 14
(Riferimento Champion: CAF2620)



10 060 5165

1000: Gsx-R 12-15 • Gsx-R Z 13-15
(Riferimento Champion: CAF2620)



TRIUMPH

10 060 5195

800: Tiger-Xc-Xr 01-16
(Riferimento Champion: CAF5501)



YAMAHA

10 060 2335

PRIMO FILTRO - 1ST AIR FILTER

400: Majesty 04-12
(Riferimento Champion: CAF3404)



10 060 2345

SECONDO FILTRO - 2ND AIR FILTER

400: Majesty 04-12
(Riferimento Champion: CAF3405)



10 060 2355

CARTER - CRANKCASE FILTER

400: Majesty 04-12
(Riferimento Champion: CAF3406)



10 060 2365

LATO SINISTRO - LEFT HAND SIDE AIR FILTER

500: T-max 01-07
(Riferimento Champion: CAF3505)



10 060 2375

LATO DESTRO - RIGHT HAND SIDE V-BELT FILTER

500: T-max White Max 10-11 • T-max 01-07 • T-max 08-11
(Riferimento Champion: CAF3506)



10 060 2445

PRIMO FILTRO - 1ST AIR FILTER

500: T-max White Max 10-11 • T-max 08-11 • Xp T-max Tech Max Abs 11
530: Xp Tmax / Black Max 12-13
(Riferimento Champion: CAF3507)



10 060 2915

125: X-City 07-13 • X-Max 06-13 • X-Max Business Abs 11 • X-Max Sport 06-13 • X-Max Abs 11-12
250: X-Max 06-13 • X-Max Sport 11-13 • X-Max Abs 11-12
(Riferimento Champion CAF3104)



10 060 4055

800: Fz8 N 10-13 • Fz8 S Fazer 8 10-13
1000: Fz1 N 06-12 • Fz1 N Abs 08-12 • Fz1 S Fazer 06-12 • Fz1 S Fazer Abs 08-12
(Riferimento Champion: CAF3917)



10 060 4125

650: Xj Maxim 80-84 • Xj Midnight 81 • Xj Seca 83 • Xj Seca 82
750: Xj 81-84
(Riferimento Champion: J300)



10 060 4145

600: Xt E 91-95 • Xt 91-95
660: Xtz Tenere 91-95
(Riferimento Champion: J302)



10 060 4215

700: Xv 86-87 • Xv 86-87 • Xv 84-87
750: Xv Virago 92-99
1000: Xv Se 88-89 • Xv Se Virago 83-85
1100: Xv Virago 97-00 • Xv Virago 89-96
(Riferimento Champion: J309)



10 060 4225

400: Xj
600: Fj 84-85 • Xj 84-85 • Xj 91-92 • Xj 86-91
(Riferimento Champion: J310)



YAMAHA

10 060 4235

1100: Fj 84-86
1200: Fj 86-95 • Fj A Abs 91-95
(Riferimento Champion: J311)



10 060 4245

900: Xj F 84-93 • Xj Seca 82-83
(Riferimento Champion: J312)



10 060 4305

750: Yzf R 93-98 • Yzf 93-98
(Riferimento Champion: J318)



10 060 4315

750: Xv 81-83 • Xv Se 81-83
920: Xv 81-82
(Riferimento Champion: J319)



10 060 4395

750: Xtz Super Tenere 90-97
(Riferimento Champion: J327)



10 060 4415

600: Fz6
(Riferimento Champion: CAF3612)



10 060 4425

900: Tdm900 02-11 • Tdm A Abs 05-11
(Riferimento Champion: J331)



10 060 4575

600: Xt 84-90
(Riferimento Champion: J304)



10 060 4605

400: Fzr Genesis 88 • Fzr R Exup 88-89
600: Fzr600 89-90 • Fzr 91-93
(Riferimento Champion: V303)



10 060 4615

535: Xv S 94-95 • Xv 87-93
(Riferimento Champion: V305)



10 060 4625

1000: Fzr (Exup) 89-90 • Fzr (Exup) 91-94
• Yzf Thunder Ace 96-02
(Riferimento Champion: V306)



10 060 4645

650: Xvs Drag Star 97-04 • Xvs A Drag Star
Classic 98-05 • Xvs A V-Star Classic
98-10 • Xvs At V-Star Silverado 02-10 • Xvs V-M
V-Star Midnight Custom 06-10
(Riferimento Champion: V308)



YAMAHA

10 060 4665



600: Xj N Diversion 97-03 • Xj S Diversion 97-98 • Xj S Diversion 99-03 • Xj Diversion 92-96
700: Fz7 87
750: Fz Genesis 87-94 • Fz 85-88 • Fzr Genesis 87-88
850: Tdm 91-01
900: Xj S Diversion 94-03
1000: Fzr Genesis 87-88
1100: Bt Bulldog 02-06
(Riferimento Champion: V311)



10 060 4795



1200: Vmx (V-Black Max) 96-00 • Vmx (V-Max) 85-95 • Vmx (V-Max) 01-07
(Riferimento Champion: Y330)

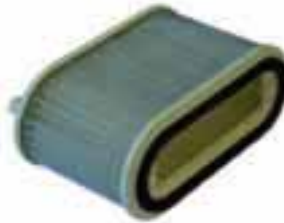

10 060 4705



500: Sr 92-00 • Sr 84-91
550: Xt 82-83
(Riferimento Champion: Y305)



10 060 2205



500: Xp T-max (Primo filtro - 1St Air Filter) 01-07
1000: Gts (2Pz necessari - 2Pcs Required) 93-00
(Riferimento Champion: Y324)



10 060 4755



1000: Yzf-R1 98-01
(Riferimento Champion: Y325)



10 060 4765



600: Fzs Fazer 98-03 • Fzs Sp Fazer 00-01
(Riferimento Champion: Y327)



10 060 4775



1200: Xjr 95-98 • Xjr Sp 97-98
1300: Xjr 99-06 • Xjr Sp 99-02
(Riferimento Champion: Y328)

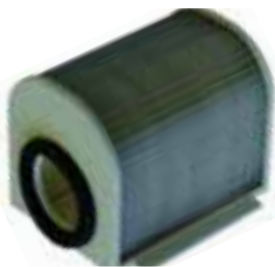

10 060 4785



1300: Xvz A Royal Star 99-02 • Xvz A Royal Star Boulevard 99-01 • Xvz Royal Star 96-98
(Riferimento Champion: Y329)



10 060 4805



600: Yzf-R6 99-02
(Riferimento Champion: Y331)



10 060 4935



125: Ybr 4T 05-12
(Riferimento Champion: CAF3103)



10 060 2745



125: Nxc Cygnus X 04-13
(Riferimento Champion: CAF3107)



10 060 2425



250: X -City 07-13 • Majesty 00-07 • X Max 05-13
300: Versity 03-06
(Riferimento Champion: CAF3203)



YAMAHA

10 060 2495



FILTRO LATO SINISTRO - LEFT SIDE FILTER

500: T-max 08-11

(Riferimento Champion: CAF3508)



10 060 2885



FILTRO LATO SINISTRO - LEFT SIDE FILTER

530: T-max 12-14

(Riferimento Champion: CAF3509)



10 060 2715



FILTRO LATO DESTRO - RIGHT SIDE FILTER

530: T-max 12-14

(Riferimento Champion: CAF3510)



10 060 5005



600: Fz6 R 09-13 • Xj6 Abs 09-14 • Xj6 Diver-
sion Abs 09-14 • Xj6 Diversion F Abs 10-14 •
Xj6 Sp 13

(Riferimento Champion CAF3615)



10 060 5175



660: Mt-03 06-12 • Xt R - X Super Motard 04-14

(Riferimento Champion CAF3613)



The background of the entire image is a repeating pattern of various mechanical and automotive icons in a light gray color. These icons include a motorcycle, a battery with a lightning bolt, a wrench and screwdriver, a piston, a gear, a bolt, a nut, a tire, a wheel, and a bolt with a nut. The icons are arranged in a grid-like fashion, creating a textured, industrial feel.

RMS

YOUR BEST PARTNER



► **FILTRI OLIO**
OIL FILTERS

► **NYPSO**
OIL FILTER

10 060 9021	Ø 41mm h 33mm Hiflo: HF185 Champion: COF085	
APRILIA (OEM): 020450 BMW (OEM): 11-41-7-651-414 • 11-41-7-672-166 ITALJET (OEM): 210483727 PEUGEOT (OEM): 737492		
10 060 9031	Ø 33mm h 36mm Hiflo: HF181 Champion: COF081	
CAGIVA (OEM): 800092541 ITALJET (OEM): 210410229 PIAGGIO (OEM): 410229		
10 060 9041	Ø 52mm h 65mm Hiflo: HF183 Champion: COF083	
APRILIA BENELLI / ADIVA DERBI / GILERA ITALJET (OEM): 210483727 MALAGUTI (OEM): 46400200 PEUGEOT (OEM): 756162 PIAGGIO (OEM): 483727 • 82635R		
10 060 9050	Ø 44mm h 55mm Hiflo: HF132 Champion: COF032	
KAWASAKI (OEM): 52010-S002 SUZUKI (OEM): 16510-25C00 • 16510-19B00 • 16510-24501 SYM (OEM): 15400-L4A-000 • 15400-L4A-0002 YAMAHA (OEM): 5RU-13440-00		
10 060 9061	Ø 44mm h 40mm Hiflo: HF131-971 Champion: COF031	
HYOSUNG SUZUKI (OEM): 16510-05240		
10 060 9071	Ø 76mm h 57mm Hiflo: HF184 Champion: COF084	
APRILIA GILERA MALAGUTI PEUGEOT (OEM): 759749 PIAGGIO (OEM): 82658R • 82960R • 830239 • 82883R		

10 060 9081 	Ø 68mm h 50mm Hiflo: HF147 Champion: COF047	
KYMCO (OEM): 1541A-LBA2-E00 YAMAHA (OEM): 5DM-13440-00		
10 060 9101 	Ø 76mm h 72mm Hiflo: HF153 Champion: COF053	
CAGIVA DUCATI (OEM): 444.4.003.5A • 09 054 99 6 • 444.4.017.1A • 444.4.003.4A GILERA		
10 060 9121 	Ø 76mm h 59mm Hiflo: HF552 Champion: COF452	
MOTO GUZZI (OEM): 14153000		
10 060 9131 	Ø 76mm h 79mm Hiflo: HF163 Champion: COF063	
BMW (OEM): 11-421-460-697 • 11-421-460-845 • 11-001-341-616		
10 060 9151 	Ø 76mm h 90mm Hiflo: HF551 Champion: COF451	
MOTO GUZZI (OEM): 30153000		
10 060 9171 	Ø 41mm h 128mm Hiflo: HF161 Champion: COF061	
BMW (OEM): 11-42-1-337-198 • 11-42-1-337-572 • 11-42-1-337-570		

10 060 9191	Ø 50mm h 38mm Hiflo: HF112-113 Champion: COF013	
<p> GASGAS (OEM): MFS450622565CT • MFS450622565C • MFS400122550 HONDA (OEM): 15412-KF0-305 • 15412-HM5-A10 • 15412-KF0-010 • 15410-KL3-670 • 15412-KF0-315 • 15410-KF0-010 • 15412-KF0-000 • 15412-KF0-020 • 15412-HM5-010 • 15410-KYJ-901 • 15410-KF0-020 KAWASAKI (OEM): 52010-1053 SUZUKI (OEM): K5201-01053 </p>		
10 060 9201	Ø 56mm h 53mm Hiflo: HF151 Champion: COF051	
<p> APRILIA (OEM): 0256185 BMW (OEM): 11-41-2-343-118 • 11-41-2-343-452 BOMBARDIER (OEM): 711256185 CCM MUZ KTM MOTORI ROTAX </p>		
10 060 9211	Ø 41mm h 69mm Hiflo: HF155 Champion: COF055	
<p> BETAMOTOR HUSABERG KTM (OEM): 580.38.005.000 • 901.38.015.000 • 580.38.005.100 • 580.38.005.101 POLARIS(ATV) (OEM): 2520754 </p>		
10 060 9221	Ø 45mm h 48mm Hiflo: HF154 Champion: COF054	
<p> HUSQVARNA (OEM): 800081675 </p>		
10 060 9241	Ø 80mm h 80mm Hiflo: HF202 Champion: COF102	
<p> HONDA (OEM): 15410-MJO-003 • 15410-MB3-003 • 15410-679-013 • 15410-MG7-003 • 15410-MB0-003 KAWASAKI (OEM): 16097-1054 • 16097-1056 </p>		
10 060 9271	Ø 72mm h 64mm Hiflo: HF133 Champion: COF033	
<p> SUZUKI (OEM): 16510-45040 • 16500-45810 • 16500-45820 </p>		



10 060 9290 	Ø 41mm h 58mm Hiflo: HF145 Champion: COF045	
APRILIA DERBI MUZ SACHS YAMAHA (OEM): 2H0-13440-90 • 5JX-13440-00 • 4X7-13440-90 • 4X7-13440-00 • 583-13440-10 • 4X7-13440-01		
10 060 9321 	Ø 69mm h 45mm Hiflo: HF111 Champion: COF011	
HONDA (OEM): 154A1-413-000 • 15412-KEA-003 • 15412-413-000 • 154A1-MA6-000 • 15412-KK9-911 • 15412-413-005		
10 060 9351 	Ø 65mm h 64mm Hiflo: HF204 Champion: COF104	
HONDA (OEM): 15410-MFJ-D01 • 15410-MCJ-003 • 15400-PFB-014 • 15410-MCJ-505 • 15410-MCJ-000 KAWASAKI (OEM): 16097-1070 • 16097-0003 • 16097-1072 • 16097-1068 • 16097-0002 MV AGUSTA (OEM): 8000A9294 SUZUKI TRIUMPH (OEM): T1210444		
10 060 9370 	Ø 44mm h 79mm Hiflo: HF562 Champion: COF462	
KYMCO (OEM): 1541A-KKC3-9000		
10 060 9380 	Ø 38mm h 46mm Hiflo: HF141-142 Champion: COF041-042	
FANTIC MBK TM RACING (OEM): F66510 • F66508 YAMAHA (OEM): 5YP-E3440-00 • 5TA-13440-00 • 1UY-13440-01 • 1UY-13440-02		
10 060 9410 	Ø 55mm h 57mm Hiflo: HF123 Champion: COF023	
KAWASAKI (OEM): 16099-004		

10 060 9450	Ø 60mm h 33mm Hiflo: HF136 Champion: COF036	
BETAMOTOR SUZUKI (OEM): 16510-38240		
10 060 9470	Ø 38mm h 38mm Hiflo: HF167 Champion: COF067	
DAELIM (OEM): 15412-KN6-9612 LML		
10 060 9480	Ø 44mm h 42mm Hiflo: HF566 Champion: COF466	
KAWASAKI (OEM): 52010-Y001 KIMCO (OEM): 1541A-LEA7-E00		
10 060 9490	Ø 41mm h 35mm Hiflo: HF186 Champion: COF086	
APRILIA (OEM): 3HAA000309		
10 060 9501	Ø 65mm h 73mm Hiflo: HF303 Champion: COF203	
HONDA (OEM): 15410-MM9-P00 • 15400-PFB-007 • 15410-MM9-305 • 15410-MT7-003 • 15410-MM9-003 15410-MM9-P01 • 15410-MM9-405 • 15412-MT7-003 • 15410-MM9-013 • 15410-MM9-P03 • 15410-MM5-003 KAWASAKI (OEM): 16097-1064 • 16097-1061 16097-0008 • 16097-0004 • 16097-1066 • 16097-1063 • 16097-1059 16097-1067 YAMAHA (OEM): 3FV-13440-20 • 5GH-13440-00 • 5GH-13440-30 • 5GH-13440-10 • 3FV-13440-00		
10 060 9511	Ø 68mm h 65mm Hiflo: HF138 Champion: COF038	
APRILIA (OEM): 857187 CAGIVA KAWASAKI (OEM): 52010-S005 KYMKO (OEM): 1541A-PWB1-900 SUZUKI (OEM): 16510-03G00 • 16510-07L00 • 16510-06B01 • 16510-03G00-X07 • 16510-34E00 • 16510-06B00		

10 060 9521 	Ø 38mm h 36mm Hiflo: HF116 Champion: COF016	
HONDA(ATV) (OEM): 15412-MEB-671 • 15412-MEN-671 HUSQVARNA (OEM): 8000A7019		
10 060 9531 	Ø 76mm h 56mm Hiflo: HF401 Champion: COF301	
HONDA (OEM): 15410-422-004 • 15412-300-024 • 15410-426-000 • 15410-422-000 • 15412-300-325 • 15410-426-010 KAWASAKI (OEM): 16099-003 TRIUMPH (OEM): 121-00-31-T0-301 YAMAHA (OEM): 36Y-13441-00		
10 060 9541 	Ø 41mm h 52mm Hiflo: HF157 Champion: COF057	
KTM (OEM): 590.38.046.000 • 590.38.046.144 • 590.38.046.100 • 590.38.046.101		
10 060 9551 	Ø 76mm h 54mm Hiflo: HF164-165 Champion: COF064-065	
BMW (OEM): 11-42-7-673-541 • 11-42-7-719-357 • 11-42-7-707-217		
10 060 9561 	Ø 76mm h 92mm Hiflo: HF171 Champion: COF071B	
HARLEY DAVIDSON (OEM): 63731-99 • 63731-99A • 63798-99		
10 060 9571 	Ø 38mm h 44mm Hiflo: HF207 Champion: COF107	
BETA (OEM): 15.26060.000 KAWASAKI (OEM): 52010-0001 SUZUKI (OEM): 16510-35G00 • K5201-00001		

10 060 9581 	Ø 56mm h 74mm Hiflo: HF152 Champion: COF052	
APRILIA (OEM): 0256187		
10 060 9591 	Ø 33mm h 87mm Hiflo: HF652 Champion: COF552	
HUSABERG HUSQVARNA KTM (OEM): 773.38.005.100 • 773.38.005.101		
10 060 9601 	Ø 41mm h 69mm Hiflo: HF655 Champion: COF555	
HUSABERG HUSQVARNA KTM (OEM): 770.38.005.001 • 770.38.005.044 • 770.38.005.000		
10 060 9621 	Ø 44mm h 44mm Hiflo: HF139 Champion: COF039	
CCM KAWASAKI (OEM): 52010-S004 SUZUKI (OEM): 16510-29F00		
10 060 9641 	Ø 76mm h 41mm Hiflo: HF144 Champion: COF044	
YAMAHA (OEM): 1L9-13440-91 • 1L9-13441-11		
10 060 9651 	Ø 60mm h 37mm Hiflo: HF137 Champion: COF037	
SUZUKI (OEM): 16510-37440 • 16510-37450		

10 060 9661 	Ø 65mm h 75mm Hiflo: HF156 Champion: COF056	
KTM (OEM): 583.38.045.100		
10 060 9671 	Ø 41mm h 130mm Hiflo: HF158 Champion: COF058	
KTM (OEM): 600.38.015.000 • 600.38.015.100		
10 060 9681 	Ø 65mm h 85mm Hiflo: HF148 Champion: COF048	
HONDA (OEM): 15400-PLM-A01PE • 15400-PLM-A02 TGB (OEM): 924153 YAMAHA (OEM): 5JW-13440-00		
10 060 9691 	Ø 76mm h 62mm Hiflo: HF160 Champion: COF060	
BMW (OEM): 11-42-7-719-357 • 11-42-7-721-779 HUSQVARNA (OEM): 7719357		
10 060 9711 	Ø 76mm h 92mm Hiflo: HF170 Champion: COF070	
HARLEY DAVIDSON (OEM): 63796-77 • 63805-80A • 63805-80T • 63806-83		
10 060 9721 	Ø 76mm h 68mm Hiflo: HF172 Champion: COF072C	
HARLEY DAVIDSON (OEM): 63782-80		

10 060 9731	Ø 76mm h 86mm Hiflo: HF174 Champion: COF074	
HARLEY DAVIDSON (OEM): 63793-01K		
10 060 9741	Ø 65mm h 73mm Hiflo: HF177 Champion: COF077	
BUELL (OEM): 63806-00Y		
10 060 9751	Ø 68mm h 65mm Hiflo: HF191 Champion: COF091	
PEUGEOT (OEM): 778117 TRIUMPH (OEM): T1210200		
10 060 9761	Ø 65mm h 65mm Hiflo: HF553 Champion: COF453	
BENELLI (OEM): 018.01.07.101.000		
10 060 9771	Ø 76mm h 58mm Hiflo: HF565 Champion: COF465	
APRILIA (OEM): 82883R • 82960R GILERA (OEM): 82883R		
10 060 9781	Ø 41mm h 87mm Hiflo: HF611 Champion: COF511	
BMW (OEM): 11-42-7-715-456 HUSQVARNA (OEM): 7715456 SHERCO (OEM): 0116		



<p>10 060 9791 </p>	<p>Ø 65mm h 65mm Hiflo: HF554 Champion: COF454</p>	
<p>MV AGUSTA (OEM): 8000A1428</p>		
<p>10 060 9801 </p>	<p>Ø 45mm h 49mm Hiflo: HF563 Champion: COF082-463</p>	
<p>APRILIA (OEM): 9150166 • 874081 DERBI HUSQVARNA (OEM): 8000B0593 PIAGGIO (OEM): 880887</p>		
<p>10 060 9811 </p>	<p>Ø 101mm h 40mm Hiflo: HF146 Champion: COF046</p>	
<p>YAMAHA (OEM): 1J7-13440-90 • 1J7-13440-91 • 1J7-13441-10</p>		
<p>10 060 9821 </p>	<p>Ø 68mm h 66mm Champion: COF100180S</p>	
<p>PIAGGIO (OEM): 438038</p>		
<p>10 060 9880 </p>	<p>Ø 44mm h 46mm Hiflo: HF568 Champion: COF468</p>	
<p>KYMCO (OEM): 1541A-LEH6-E00</p>		

10 060 9010 	Ø 96mm h 96,5mm	
PIAGGIO (OEM): 222721 • 830424		
10 060 9140 	Ø 76mm h 61,5mm	
AIXAM (OEM): 1WL098 LIGIER (OEM): 112397 MICROCAR : Lombardini motore LDW502 PIAGGIO (OEM): 850284 • 112397L		
10 060 9180 	Ø 45mm h 104,5mm	
MOTO GUZZI (OEM): 27153085		
10 060 9360 	Ø 65mm h 72mm	
AIXAM (Kubota diesel) (OEM): 15853-99170		
10 060 9420 	 Ø 45mm h 89mm	
MOTO GUZZI (OEM): 19153000 • 19053099		

CROSS REFERENCES

HIFLO-NYP SO

HIFLO	NYP SO
HF111	10 060 9321
HF112	10 060 9191
HF113	10 060 9191
HF116	10 060 9521
HF123	10 060 9410
HF131	10 060 9061
HF132	10 060 9050
HF133	10 060 9271
HF136	10 060 9450
HF137	10 060 9651
HF138	10 060 9511
HF139	10 060 9621
HF141	10 060 9380
HF142	10 060 9380
HF144	10 060 9641
HF145	10 060 9290
HF146	10 060 9811
HF147	10 060 9081
HF148	10 060 9681
HF151	10 060 9201
HF152	10 060 9581
HF153	10 060 9101
HF154	10 060 9221
HF155	10 060 9211
HF156	10 060 9661
HF157	10 060 9541
HF158	10 060 9671
HF160	10 060 9691
HF161	10 060 9171
HF163	10 060 9131
HF164	10 060 9551
HF165	10 060 9551
HF167	10 060 9470
HF171	10 060 9561
HF172	10 060 9721
HF174	10 060 9731
HF177	10 060 9741
HF181	10 060 9031
HF183	10 060 9041
HF184	10 060 9071
HF185	10 060 9021
HF186	10 060 9490
HF191	10 060 9751
HF202	10 060 9241
HF204	10 060 9351
HF207	10 060 9571
HF303	10 060 9501
HF401	10 060 9531
HF551	10 060 9151
HF552	10 060 9121
HF553	10 060 9761
HF554	10 060 9791
HF562	10 060 9370
HF563	10 060 9801
HF565	10 060 9771
HF566	10 060 9480
HF568	10 060 9880
HF611	10 060 9781
HF652	10 060 9591
HF655	10 060 9601
HF971	10 060 9061

CHAMPION-NYP SO

CHAMPION	NYP SO
COF011	10 060 9321
COF013	10 060 9191
COF016	10 060 9521
COF023	10 060 9410
COF031	10 060 9061
COF032	10 060 9050
COF033	10 060 9271
COF036	10 060 9450
COF037	10 060 9651
COF038	10 060 9511
COF039	10 060 9621
COF041	10 060 9380
COF042	10 060 9380
COF044	10 060 9641
COF045	10 060 9290
COF046	10 060 9811
COF047	10 060 9081
COF048	10 060 9681
COF051	10 060 9201
COF052	10 060 9581
COF053	10 060 9101
COF054	10 060 9221
COF055	10 060 9211
COF056	10 060 9661
COF057	10 060 9541
COF058	10 060 9671
COF060	10 060 9691
COF061	10 060 9171
COF063	10 060 9131
COF064	10 060 9551
COF065	10 060 9551
COF067	10 060 9470
COF071B	10 060 9561
COF072C	10 060 9721
COF074	10 060 9731
COF077	10 060 9741
COF081	10 060 9031
COF082	10 060 9801
COF083	10 060 9041
COF084	10 060 9071
COF085	10 060 9021
COF086	10 060 9490
COF091	10 060 9751
COF102	10 060 9241
COF104	10 060 9351
COF107	10 060 9571
COF203	10 060 9501
COF301	10 060 9531
COF451	10 060 9151
COF452	10 060 9121
COF453	10 060 9761
COF454	10 060 9791
COF462	10 060 9370
COF463	10 060 9801
COF465	10 060 9771
COF466	10 060 9480
COF468	10 060 9880
COF511	10 060 9781
COF552	10 060 9591
COF555	10 060 9601
COF100180S	10 060 9821



CC	MODELLO - MODEL	ANNO YEAR	NYP SO	CC	MODELLO - MODEL	ANNO YEAR	NYP SO
ADIVA				BENELLI			
125	AD Eu3	01-08	10 060 9041	125	Adiva	00-03	10 060 9041
250	AD (Piaggio) Eu2-Eu3	06-11	10 060 9041	150	Adiva	00-03	10 060 9041
400	AD-Cabrio (Piaggio)	09-11	10 060 9071	250	Adiva	06-08	10 060 9041
AIXAM				BETAMOTOR			
400	Serie 400 Mac (Kubota Diesel)	UFI 92->	10 060 9360	899	899-900 (Tutti - All Models) Cafe Racer-TNT-Tornado	10-11	10 060 9761
400	Serie 400 SL (Kubota Diesel)	UFI 92->	10 060 9360	1130	1130 (tutti) Cafe Racer-TNT-Trek	04-11	10 060 9761
500	Serie 500.5 (Lombardini LGW523)	UFI 05->	10 060 9140	BETAMOTOR			
500	Serie A751 (Lombardini LGW523)	UFI 05->	10 060 9140	250	250 Evo 4T	09-14	10 060 9571
500	Serie Crossline MPI (Lombardini LGW523)	UFI 05->	10 060 9140	250	250 Rev 4T	07-08	10 060 9571
500	Serie Roadline MPI (Lombardini LGW523)	UFI 05->	10 060 9140	250	250 RR Enduro 4T (1°filtro -1st filter)	05-09	10 060 9211
500	Serie Scouty GT/GT R (Lombardini LGW523)	UFI 05->	10 060 9140	250	250 RR Enduro 4T (2°filtro - 2nd filter)	05-09	10 060 9541
APRILIA				300	300 Evo 4T	09-14	10 060 9571
125	Atlantic	02-13	10 060 9041	350	350 Alp 4.0-M4 4T-Motard 4.0	01-14	10 060 9450
125	Habana-Habana Custom	99-02	10 060 9031	400	400 RR Enduro 4T (1°filtro -1st filter)	05-09	10 060 9211
125	Leonardo-ST	96-05	10 060 9021	400	400 RR Enduro 4T (2°filtro - 2nd filter)	05-09	10 060 9541
125	Mojito- Mojito Custom	03-10	10 060 9041	450	450 RR Enduro 4T (1°filtro -1st filter)	05-09	10 060 9211
125	Mojito Retro-Custom	99-02	10 060 9031	450	450 RR Enduro 4T (2°filtro - 2nd filter)	05-09	10 060 9541
125	RS4	11-14	10 060 9801	525	525 RR Enduro 4T (1°filtro -1st filter)	05-09	10 060 9211
125	Scarabeo (Piaggio)	03-05	10 060 9041	525	525 RR Enduro 4T (2°filtro - 2nd filter)	05-09	10 060 9541
125	Scarabeo GT-Street (Piaggio) Eu3	03-07	10 060 9041	BMW			
125	Scarabeo Light-i.e.-Net	07-13	10 060 9490	125	125 C1	01-03	10 060 9021
125	Scarabeo-GT (Rotax)	99-03	10 060 9021	200	200 C1	02-03	10 060 9021
125	Sport City Cube-One-Street	02-13	10 060 9041	450	G450 X	09-12	10 060 9781
125	SR Max 4T-Motard 4T	11-14	10 060 9041	450	R45-N	78-80	10 060 9171
150	Leonardo-ST	96-05	10 060 9021	500	R50/5	69-73	10 060 9171
150	Mojito-Custom	03-08	10 060 9041	600	C600 Sport	12-15	10 060 9551
150	Scarabeo-GT	99-03	10 060 9021	600	R60 (Tutti - All Models)	69-88	10 060 9171
200	Atlantic	03-08	10 060 9041	650	C650 GT	12-15	10 060 9551
200	Scarabeo (Piaggio)	03-05	10 060 9041	650	F650 CS-F-GS-Dakar-ST	93-07	10 060 9201
200	Scarabeo GT-Street (Piaggio) Eu3	03-07	10 060 9041	650	G650 (tutte-all models) GS-X	07-15	10 060 9201
200	Scarabeo Light-i.e.-Net	07-13	10 060 9490	750	K75 (Tutti - All Models)	85-97	10 060 9131
200	Scarabeo-GT (Rotax)	99-03	10 060 9021	750	R75 (Tutti - All Models)		10 060 9171
200	Sport City-Cube Eu3	04-13	10 060 9041	800	F650 GS SE	08-11	10 060 9691
250	Atlantic-i.e.	04-09	10 060 9041	800	F700 GS	13-15	10 060 9691
250	Scarabeo-GT-i.e.-Light (Piaggio)	03-11	10 060 9041	800	F800 GS-Adventure	07-15	10 060 9691
250	Sport City-Cube i.e. Eu3	06-11	10 060 9041	800	F800 GT	13-15	10 060 9691
300	Atlantic	10-13	10 060 9041	800	F800 R	10-15	10 060 9691
300	Scarabeo Light-Special Eu3	09-13	10 060 9041	800	F800 S	06-10	10 060 9551
300	Sport City Cube i.e.-Street Eu3	08-13	10 060 9041	800	F800 ST	06-13	10 060 9551
300	SR Max	11-14	10 060 9041	800	F800 ST Touring	12	10 060 9551
311	TX-ADV-M	85-93	10 060 9201	800	R80 (Tutti - All Models)	80-95	10 060 9171
320	TR	78-84	10 060 9201	850	R850 (Tutti - All Models)	99-06	10 060 9131
350	ETX-Tuareg Wind	85-92	10 060 9201	900	R90 (Tutti - All Models)	73-76	10 060 9171
400	Atlantic Sprint	06-09	10 060 9071	1000	1000 HP4	13-15	10 060 9691
400	Scarabeo-Light	06-09	10 060 9071	1000	K 1-K100 (Tutti - All Models)	83-94	10 060 9131
450	RXV SXV	06-14	10 060 9801	1000	R100 (Tutti - All Models)	73-96	10 060 9171
500	Atlantic-Sprint	01-09	10 060 9071	1000	S1000 R-RR-RR Sport	10-15	10 060 9691
500	Scarabeo GT-Abs-Light	02-13	10 060 9071	1100	K1100 (Tutti - All Models)	92-99	10 060 9131
550	RXV SXV	06-14	10 060 9801	1100	R1100 (Tutti - All Models)	93-05	10 060 9131
600	ETX-Pegaso-Tuareg	85-93	10 060 9201	1150	R1150 (Tutti - All Models)	99-06	10 060 9131
650	6.5 Moto-Stark	95-01	10 060 9201	1170	R nine T	14-15	10 060 9551
650	Pegaso	93-04	10 060 9201	1200	K1200 C	99-99	10 060 9131
660	Pegaso Street-Trail-Factory	05-13	10 060 9290	1200	K1200 GT	04-08	10 060 9131
750	SL 750 Shiver-GT-Abs	07-14	10 060 9771	1200	K1200 LT-RS-RS SE	99-08	10 060 9131
750	SMV 750 Dorsoduro-Abs	08-14	10 060 9771	1200	K1200 R-S-RS-RS SE	05-08	10 060 9691
850	Mana-GT-Abs	07-14	10 060 9771	1200	R1200 C (Tutti - All Models)	99-05	10 060 9131
850	SRV	12-14	10 060 9771	1200	R1200 CL	03-05	10 060 9131
1000	ETV 1000 Caponord	01-08	10 060 9581	1200	R1200 GS	04-09	10 060 9551
1000	RST 1000 Futura	01-06	10 060 9581	1200	R1200 GS-ADV	10-13	10 060 9551
1000	RSV 1000 Mille-Tuono	99-10	10 060 9581	1200	R1200 GS-ADV	13-14	10 060 9691
1000	RSV 1000 RSV4 R-Tuono V4	09-16	10 060 9511	1200	R1200 HP2 Enduro-Megamoto-Sport	05-10	10 060 9551
1000	SL 1000 Falco	00-06	10 060 9581	1200	R1200 R	07-15	10 060 9551
1200	Caponord	13-14	10 060 9771	1200	R1200 RT	05-14	10 060 9551
1200	Dorsoduro-Abs-ATC	11-16	10 060 9771	1200	R1200 S	06-09	10 060 9551
				1200	R1200 ST	05-08	10 060 9551
				1300	K1300 (Tutti - All Models) GT-GT SE-R-R-R Dynamic-S-S HP-S Sport	09-14	10 060 9691
				1600	K1600 (Tutti - All Models)	11-15	10 060 9551

CC	MODELLO - MODEL	ANNO YEAR	NYP SO	CC	MODELLO - MODEL	ANNO YEAR	NYP SO
BUELL				796	796 Monster	11-14	10 060 9101
500	500 Blast	02-09	10 060 9741	800	800 Monster	03-07	10 060 9101
900	900 XB9 (tutte-all models)	02-10	10 060 9741	800	800 Sport	03-03	10 060 9101
1200	1200 Cyclone M2	97-02	10 060 9561	800	800 SS	03-07	10 060 9101
1200	1200 Lightning S1,X1	94-02	10 060 9561	820	820 Hypermotard-Hyperstrada	13-14	10 060 9101
1200	1200 Thunderbolt S2,S2T,S3,S3T	94-02	10 060 9561	848	848	08-10	10 060 9101
1200	1200 White Lightning X1W	02	10 060 9561	848	848-Evo-Streetfighter	11-14	10 060 9101
1200	1200 XB12 (tutte-all models)	04-10	10 060 9741	851	851 Strada	89-92	10 060 9101
CAGIVA				888	888 Strada	92-94	10 060 9101
125	125 Cucciolo/Nuvola	00	10 060 9031	900	900 FE	98-99	10 060 9101
350	350 Alazzurra TL,GT		10 060 9101	900	900 MH	01	10 060 9101
650	650 Alazzurra	82-88	10 060 9101	900	900 Monster	93-02	10 060 9101
650	650 Raptor i.e.-V-Raptor	00-05	10 060 9511	900	900 S2	79-85	10 060 9101
750	750 Elefant	93-97	10 060 9101	900	900 Sport	02	10 060 9101
900	900 Elefant	90-97	10 060 9101	900	900 Super Sport	90-02	10 060 9101
900	900 Grand Canyon	90-92	10 060 9101	906	906 Paso Sports	88-91	10 060 9101
1000	1000 Navigator	00-05	10 060 9511	907	907 I.E.	90-93	10 060 9101
1000	1000 Raptor-V-Raptor-Xtra-Raptor	00-05	10 060 9511	916	916 Monster S4	01-03	10 060 9101
CCM				916	916 Senna	93-99	10 060 9101
404	404 (Tutti - All Models)		10 060 9621	944	944 ST2	97-03	10 060 9101
604	604 (Tutti - All Models)		10 060 9201	989	989 Desmosedici RR	08	10 060 9101
644	644 (Tutti - All Models)		10 060 9651	992	992 S2R 1000	06	10 060 9101
CASALINI				992	992 ST3	04-07	10 060 9101
505	Sulky 505 Diesel (Lombardini LDW 502)	UFI 95->	10 060 9140	996	996	00-01	10 060 9101
505	Ydea 505 GLX Diesel (Lombardini)	UFI	10 060 9140	996	996 Biposto	99-06	10 060 9101
DAELIM				996	996 Monster S4R	04-06	10 060 9101
125	VC125	96	10 060 9470	996	996 ST4 S	02-05	10 060 9101
125	VS125 Evolution	97-05	10 060 9470	998	998	02-03	10 060 9101
125	VT125 Evolution	97-05	10 060 9470	998	998 Monster S4R Testastretta	07-08	10 060 9101
DERBI				999	999	03-06	10 060 9101
125	Boulevard Eu3	02-13	10 060 9041	1000	1000 DS-S	04-06	10 060 9101
125	GP1 E2-Low Seat E3	06-11	10 060 9041	1000	1000 GT Sportclassic	07-10	10 060 9101
125	GPR 4T	09-13	10 060 9801	1000	1000 Monster i.e.-S-S2R	03-08	10 060 9101
125	Mulhacen 4T	07-13	10 060 9801	1000	1000 Smart	06	10 060 9101
125	Rambla	08-13	10 060 9041	1000	1000 Sport	06-09	10 060 9101
125	Senda R	09-13	10 060 9801	1000	1000 SS	03-05	10 060 9101
125	Sonar	10-13	10 060 9041	1098	1098	07-08	10 060 9101
125	Terra	07-13	10 060 9801	1098	1098 R-S	07-08	10 060 9101
200	Boulevard Eu3	02-08	10 060 9041	1099	1099 Streetfighter-S	09-13	10 060 9101
250	Boulevard	02-08	10 060 9041	1100	1100 Hypermotard-S	08-12	10 060 9101
250	GP1	06-09	10 060 9041	1100	1100 Monster	08-13	10 060 9101
250	Rambla	08-10	10 060 9041	1100	1100 Multistrada-S	07-09	10 060 9101
300	Rambla i	10-13	10 060 9041	1198	1198	09-11	10 060 9101
660	Mulhacen	06-12	10 060 9290	1198	1198 Diavel	11-14	10 060 9101
DUCATI				1200	1200 Monster	14	10 060 9101
350	350 F3		10 060 9101	1200	1200 Multistrada	10-14	10 060 9101
350	350 Indiana		10 060 9101	FANTIC			
350	350 Pantah		10 060 9101	125	125 Caballero	08-13	10 060 9380
400	400 SS Junior Super Sport	92-94	10 060 9101	GAS GAS			
600	600 Monster	93-01	10 060 9101	250	EC250 F 4T	10-11	10 060 9380
600	600 SL Pantah Sports	81-85	10 060 9101	400	400 FSE-SM	03-07	10 060 9191
600	600 SS	93-98	10 060 9101	450	450 FSE-SM	03-08	10 060 9191
620	620 Monster	03-06	10 060 9101	450	450 Pampera	07-08	10 060 9191
620	620 Multistrada	06	10 060 9101	510	510 EC-SM	09	10 060 9191
620	620 Sport	03	10 060 9101	GILERA			
650	650 Indiana Custom	86-88	10 060 9101	125	Arcore		10 060 9101
695	695 Monster	07-08	10 060 9101	125	DNA	01-03	10 060 9041
696	696 Monster	09-14	10 060 9101	125	Nexus	07-13	10 060 9041
748	748	94-03	10 060 9101	125	Runner VX-VXR-SC-ST-Race Eu3	02-14	10 060 9041
749	749	03-06	10 060 9101	180	DNA	01-03	10 060 9041
750	750 F1 MKII	85-87	10 060 9101	180	Runner VXR	01-03	10 060 9041
750	750 Indiana Custom	87-88	10 060 9101	200	Runner VX-VXR-SC-ST-Race Eu3	03-13	10 060 9041
750	750 Monster	96-02	10 060 9101	250	Nexus-SP	06-08	10 060 9041
750	750 Paso	86-90	10 060 9101	300	Nexus i.e. Eu3	08-13	10 060 9041
750	750 Sport	01-02	10 060 9101	500	Fuoco	07-12	10 060 9071
750	750 Sport	88-90	10 060 9101	500	Nexus-SP	03-13	10 060 9071
750	750 SS	91-02	10 060 9101	800	GP-GP Centenario	08-14	10 060 9771
795	795 Monster	12-14	10 060 9101				
796	796 Hypermotard	10-12	10 060 9101				

CC	MODELLO - MODEL	ANNO YEAR	NYP SO	CC	MODELLO - MODEL	ANNO YEAR	NYP SO
1340	FXDWG Dyna Wide Glide	99-05	10 060 9561				
1340	FXDWG Dyna Wide Glide ie	04-06	10 060 9561	1450	FLHTCUSE6 CVO SE Ultra Classic Electra Glide ie	11	10 060 9561
1340	FXDX Dyna Super Glide Sport	99-05	10 060 9561				
1340	FXDXI Dyna Super Glide Sport ie	04-05	10 060 9561	1450	FLHTCUSE7 CVO SE Ultra Classic Electra Glide ie	12	10 060 9561
1340	FXDXT Dyna Super Glide T-Sport	01-03	10 060 9561				
1340	FXE Super Glide	82-84	10 060 9721	1450	FLHTCUSE8 CVO SE Ultra Classic Electra Glide ie	13-14	10 060 9561
1340	FXEF Fat Boy	85	10 060 9721	1450	FLHTCUTG Tri Glide Ultra Classic	10-15	10 060 9561
1340	FXLR Low Rider	87-94	10 060 9711	1450	FLHTK Electra Glide Ultra Limited	10-15	10 060 9561
1340	FXLR Low Rider	87-94	10 060 9711	1450	FLHTP Electra Glide Police	09	10 060 9561
1340	FXR Super Glide	82-94	10 060 9711	1450	FLHX Street Glide ie	07-15	10 060 9561
1340	FXR Super Glide	82-94	10 060 9711	1450	FLHX/XI Street Glide ie	06	10 060 9561
1340	FXRC Low Rider	87->	10 060 9711	1450	FLHXSE CVO Street Glide ie	10	10 060 9561
1340	FXRC Low Rider	87->	10 060 9711	1450	FLHXSE2 CVO Street Glide ie	11	10 060 9561
1340	FXRD Grand Touring	86->	10 060 9711	1450	FLHXSE3 CVO Street Glide ie	12	10 060 9561
1340	FXRD Grand Touring	86->	10 060 9711	1450	FLHXXX Street Glide Trike	10-11	10 060 9561
1340	FXRS Low Glide	82-82	10 060 9711	1450	FLS Softail Slim	13-15	10 060 9561
1340	FXRS Low Glide	82-82	10 060 9711	1450	FLST Heritage Softail	06	10 060 9561
1340	FXRS Low Rider	87-94	10 060 9711	1450	FLSTC Heritage Softail Classic ie	07-15	10 060 9561
1340	FXRS Low Rider	87-94	10 060 9711	1450	FLSTF Fat Boy ie	03-15	10 060 9561
1340	FXRS Low Rider Convertible	90-94	10 060 9711	1450	FLSTFB Fat Boy Lo ie	10-15	10 060 9561
1340	FXRS Low Rider Convertible	90-94	10 060 9711	1450	FLSTFB Fat Boy Special	12	10 060 9561
1340	FXRT Sport Glide	83-89	10 060 9711	1450	FLSTI Heritage Softail ie	06	10 060 9561
1340	FXRT Sport Glide	83-89	10 060 9711	1450	FLSTN Softail Deluxe ie	07-15	10 060 9561
1340	FXSBSE CVO Breakout	13-15	10 060 9561	1450	FLSTN/NI Softail Deluxe ie	05-06	10 060 9561
1340	FXST Softail	84-85	10 060 9711	1450	FLSTSB Softail Cross Bones	09-11	10 060 9561
1340	FXST Softail	84-85	10 060 9711	1450	FLSTSC Softail Springer Classic ie	07	10 060 9561
1340	FXST Softail	87-90	10 060 9711	1450	FLSTSE CVO Softail Convertible	10	10 060 9561
1340	FXST Softail	87-90	10 060 9711	1450	FLSTSE2 CVO Softail Convertible	11	10 060 9561
1340	FXSTB Night Train	99->	10 060 9711	1450	FLSTSE3 CVO Softail Convertible	12	10 060 9561
1340	FXSTB Night Train	99->	10 060 9711	1450	FLTR Road Glide ie	07-09	10 060 9561
1340	FXSTB Night Train ie	00-06	10 060 9561	1450	FLTRSE3 CVO Road Glide	09	10 060 9561
1340	FXSTC Softail Custom	00	10 060 9561	1450	FLTRU Road Glide Ultra	11-15	10 060 9561
1340	FXSTC Softail Custom	87-99	10 060 9711	1450	FLTRUSE CVO Road Glide Ultra	11	10 060 9561
1340	FXSTC Softail Custom	87-99	10 060 9711	1450	FLTRX Road Glide Custom	10-15	10 060 9561
1340	FXSTD Softail Deuce	00-06	10 060 9561	1450	FLTRXSE CVO Road Glide Custom	12	10 060 9561
1340	FXSTDI Softail Deuce ie	01-06	10 060 9561	1450	FLTRXSE2 CVO Road Glide Custom	12-14	10 060 9561
1340	FXSTDSE Screamin' Eagle Softail Deuce	03-04	10 060 9561	1450	FXCW Softail Rocker	09	10 060 9561
1340	FXSTS Springer Softail	00-06	10 060 9561	1450	FXCWC Softail Rocker C	09-11	10 060 9561
1340	FXSTS Springer Softail	87-99	10 060 9711	1450	FXDB Street Bob ie	07-15	10 060 9561
1340	FXSTS Springer Softail	87-99	10 060 9711	1450	FXDBI Street Bob ie	06	10 060 9561
1340	FXSTSB Bad Boy	96->	10 060 9711	1450	FXDC Dyna Super Glide Custom ie	07-14	10 060 9561
1340	FXSTSB Bad Boy	96->	10 060 9711	1450	FXDF Dyna Fat Bob	09-15	10 060 9561
1340	FXSTSI Springer Softail ie	03-06	10 060 9561	1450	FXDFSE Dyna Fat Bob	09	10 060 9561
1340	FXWG Wide Glide	82-86	10 060 9721	1450	FXDFSE2 CVO Dyna Fat Bob	10	10 060 9561
1340	VRSCA V-Rod	02-06	10 060 9731	1450	FXDI Dyna Super Glide ie	04-10	10 060 9561
1340	VRSCAW V-Rod ie	07-09	10 060 9731	1450	FXDI35 35th Anniversary Dyna Super Glide ie	06	10 060 9561
1340	VRSCB V-Rod	04-05	10 060 9731	1450	FXDSE Screamin' Eagle Dyna ie	07	10 060 9561
1340	VRSCD Night Rod	06	10 060 9731	1450	FXDSE2 Screamin' Eagle Dyna ie	08	10 060 9561
1340	VRSCD Night Rod ie	07-08	10 060 9731	1450	FXDWG Dyna Wide Glide ie	07-15	10 060 9561
1340	VRSCDX Night Rod Special ie	07-15	10 060 9731	1450	FXST Softail Standard ie	00-07	10 060 9561
1340	VRSCF V-Rod Muscle	09-15	10 060 9731	1450	FXSTB Night Train ie	07-09	10 060 9561
1340	VRSCR Street Rod	06	10 060 9731	1450	FXSTC Softail Custom ie	07-10	10 060 9561
1340	VRSCR Street Rod ie	07	10 060 9731	1450	FXSTD Softail Deuce ie	07	10 060 9561
1340	VRSCSE Screamin' Eagle V-Rod	05	10 060 9731	1450	FXSTSSE SE Softail Springer ie	07	10 060 9561
1340	VRSCX ie	07	10 060 9731	1450	FXSTSSE2/3 SE Softail Springer ie	08-09	10 060 9561
1450	FLHRC Road King Classic ie	07-15	10 060 9561	1584	FXS Blackline	12-13	10 060 9561
1450	FLHRS Road King Custom ie	07	10 060 9561	1690	FLD Switchback	12-15	10 060 9561
1450	FLHRSE3 Screamin' Eagle Road King ie	07	10 060 9561	1690	FLHXS Street Glide Special ie	14-15	10 060 9561
1450	FLHRSE4 Screamin' Eagle Road King ie	08	10 060 9561	1690	FLRT Freewheeler	15	10 060 9561
1450	FLHRSE5 CVO Road King	13	10 060 9561	1690	FLSTN CVO Softail Deluxe ie	14-15	10 060 9561
1450	FLHTCSE Screamin' Eagle Electra Glide	04	10 060 9561	1690	FXSB Breakout	13-15	10 060 9561
1450	FLHTCSE2 Screamin' Eagle Electra Glide 2	05	10 060 9561	1802	FLHRSE6 CVO Road King	14	10 060 9561
1450	FLHTCU Ultra Classic Electra Glide ie	07-15	10 060 9561	1802	FLHTKSE CVO SE Electra Glide Ultra Limited	10-15	10 060 9561
1450	FLHTCUSE2 SE Ultra Classic Electra Glide ie	07	10 060 9561	HONDA			
1450	FLHTCUSE3 SE Ultra Classic Electra Glide ie	08	10 060 9561	125	CBF125	14	10 060 9191
1450	FLHTCUSE4/5 CVO SE Ultra Classic Electra Glide ie	09-10	10 060 9561	125	VT125 Shadow	99-08	10 060 9191
				125	XL125 V Varadero	01-12	10 060 9191

CC	MODELLO - MODEL	ANNO YEAR	NYP SO	CC	MODELLO - MODEL	ANNO YEAR	NYP SO
125	XL125 V Varadero De Luxe	11	10 060 9191	600	XL600	83-88	10 060 9191
150	CRF150 R	07-15	10 060 9521	600	XL600 V Transalp	87-07	10 060 9501
200	XR200 R	84-02	10 060 9191	600	XR600	85-02	10 060 9191
250	AX1		10 060 9191	650	CB650	14-15	10 060 9351
250	CB250	78-85	10 060 9321	650	CB650	79-84	10 060 9531
250	CBF250	04-06	10 060 9191	650	CB650	91-92	10 060 9501
250	CBR250	11-13	10 060 9191	650	CBR650 F	14-15	10 060 9351
250	CBX250 RS	00	10 060 9191	650	CX650	83-86	10 060 9321
250	CBX250 RSE	83-86	10 060 9191	650	FMX650	05-07	10 060 9191
250	CM250 Custom	81-85	10 060 9321	650	FX650 Vigor	99-02	10 060 9191
250	CRF250	04-15	10 060 9191	650	GL650 Silver Wing	83-86	10 060 9321
250	NSS250 Forza	08-12	10 060 9351	650	NT650 Hawk GT	88-91	10 060 9501
250	NX250	88-95	10 060 9191	650	NT650 V Deauville	98-05	10 060 9501
250	TLR250	85-87	10 060 9191	650	NTV650 Revere	93-97	10 060 9501
250	VT250	83-90	10 060 9321	650	NX650 Dominator	88-02	10 060 9191
250	VTR250	88-90	10 060 9321	650	SLR650 Vigor	97-00	10 060 9191
250	XL250	82-90	10 060 9191	650	XR650	93-15	10 060 9191
250	XR250	82-04	10 060 9191	650	XRV650 Africa Twin	88-90	10 060 9501
300	CB300	15	10 060 9191	700	700 Integra (DCT)	12-13	10 060 9351
300	CBR300	14-15	10 060 9191	700	CTX700	14-15	10 060 9351
300	NSS300 Forza	13-14	10 060 9351	700	NC700	12-15	10 060 9351
300	SH300i (Abs)	07-13	10 060 9351	700	NSA700 A	08-10	10 060 9351
350	CB350	73-74	10 060 9531	700	NT700 Deauville (Abs)	06-13	10 060 9351
350	CB350	86-89	10 060 9321	700	XL700 V Transalp	08-13	10 060 9351
350	XL350	85-87	10 060 9191	750	CB750	70-85	10 060 9531
350	XL-X350		10 060 9191	750	CB750	91-03	10 060 9501
350	XR350	83-87	10 060 9191	750	CBX750 FE,FG,F2G	84-86	10 060 9241
400	CB400	78-84	10 060 9321	750	RVF750 R	94-98	10 060 9501
400	CB400 F,F1,F2	75-79	10 060 9531	750	VF750	82-89	10 060 9241
400	CB400 F,FK (CB-1)	89-92	10 060 9501	750	VF750	93-03	10 060 9501
400	CBR400 RR		10 060 9501	750	VFR750	86-87	10 060 9241
400	CBX400 F	83-86	10 060 9321	750	VFR750	88-98	10 060 9501
400	CM400 Chopper	81-83	10 060 9321	750	VT750 C Shadow	83	10 060 9241
400	CM400 Chopper	79-80	10 060 9321	750	VT750 C Shadow	04-15	10 060 9351
400	CX400	82-84	10 060 9321	750	VT750 CD CD2 Shadow	97-07	10 060 9501
400	FSC400 Silver Wing	06-13	10 060 9351	750	XRV750 Africa Twin	90-02	10 060 9501
400	VF400 FD	83-86	10 060 9241	800	PC800 Pacific Coast	89-90	10 060 9501
400	VFR400 R	87-93	10 060 9501	800	PC800 Pacific Coast	95-98	10 060 9501
400	XR400	96-04	10 060 9191	800	VFR800	98-01	10 060 9501
440	XR440 R-SM	96-04	10 060 9191	800	VFR800 Crossrunner	11-15	10 060 9351
450	CB450 DXK	85-92	10 060 9321	800	VFR800-V TEC-(Abs)	02-11	10 060 9351
450	CM450 Custom	82-83	10 060 9321	800	VT800 Shadow	88	10 060 9241
450	CRF450 R	02-15	10 060 9521	900	CB900 F	79-84	10 060 9531
500	CB500	13-15	10 060 9351	900	CB900 F Hornet	02-07	10 060 9351
500	CB500	94-02	10 060 9501	900	CBR900 RR Fire Blade	92-99	10 060 9501
500	CB500 F Four	71-77	10 060 9531	900	CBR900 RR Fire Blade	00-03	10 060 9351
500	CB500 Twin	75-77	10 060 9321	1000	CB1000 C Custom	83	10 060 9531
500	CBF500	04-08	10 060 9501	1000	CB1000 FP,FR,FS,FT,FV BIG 1	93-97	10 060 9501
500	CBR500	13-15	10 060 9351	1000	CB1000 R/RA-8,9,A,B,C,D,E,F	08-15	10 060 9351
500	CX 500	78-84	10 060 9321	1000	CBF1000	06-15	10 060 9351
500	GB500 TT, K Clubman	89-90	10 060 9191	1000	CBR1000 F Hurricane	87-99	10 060 9501
500	GL500 I Interstate	81-82	10 060 9321	1000	CBR1000 RR Fireblade (C-Abs)	04-15	10 060 9351
500	GL500 Silver Wing	81-82	10 060 9321	1000	CBX1000	78-82	10 060 9531
500	VF500	84-87	10 060 9241	1000	GL1000 Gold Wing	75-80	10 060 9531
500	VT500 Shadow	83-88	10 060 9241	1000	VF1000 F-R-RF-Interceptor	84-86	10 060 9241
500	XBR500	85-88	10 060 9191	1000	VTR1000 F Fire Storm	03-05	10 060 9351
500	XR500	81-85	10 060 9191	1000	VTR1000 F Fire Storm	97-02	10 060 9501
550	CB550	74-83	10 060 9531	1000	VTR1000 SP-1	00	10 060 9501
550	CBX550	81-86	10 060 9321	1000	VTR1000 SP-1/ SP-2	01-06	10 060 9351
600	CB600 Hornet	03-13	10 060 9351	1000	XL1000 V Varadero-Abs	03-13	10 060 9351
600	CB600 Hornet	98-02	10 060 9501	1000	XL1000 V-X,Y,1,2 Varadero	99-02	10 060 9501
600	CBF600	04-12	10 060 9351	1050	CBX1050	79-80	10 060 9531
600	CBR600 F	11-13	10 060 9351	1100	CB1100	81-83	10 060 9531
600	CBR600 F	01-07	10 060 9351	1100	CB1100 D,E	13-14	10 060 9351
600	CBR600 F	87-00	10 060 9501	1100	CB1100 X-Eleven	00-03	10 060 9501
600	CBR600 RR	03-15	10 060 9351	1100	CBR1100 XX BlackBird	97-06	10 060 9501
600	FSC600 Silver Wing	01-13	10 060 9351	1100	GL1100 Gold Wing	80-85	10 060 9531
600	NTV600	88-92	10 060 9501	1100	ST1100 Pan European-Abs	90-02	10 060 9501
600	VT600 Shadow	88-07	10 060 9501	1100	ST1100-Abs	90-98	10 060 9501

CC	MODELLO - MODEL	ANNO YEAR	NYP SO	CC	MODELLO - MODEL	ANNO YEAR	NYP SO
1100	VF1100 C-S	82-86	10 060 9241	510	TC510	05-07	10 060 9221
1100	VT1100 Shadow	87-88	10 060 9241	510	TC510	08-10	10 060 9801
1100	VT1100 Shadow	89-07	10 060 9501	510	TCX510	08-11	10 060 9801
1200	GL1200 Gold Wing	84-90	10 060 9531	510	TE510	04-07	10 060 9221
1200	VFR1200 F V4-DCT	10-15	10 060 9351	510	TE510	08-10	10 060 9801
1200	VFR1200 X Crosstourer-DCT	12-15	10 060 9351	510	TXC510	08-09	10 060 9801
1300	CB1300 (Abs)	03-13	10 060 9351	511	SMR511	11-12	10 060 9781
1300	CTX1300	14-15	10 060 9351	511	TE511	11-14	10 060 9781
1300	ST1300 Pan European-Abs	02-15	10 060 9351	530	SM530 RR	09	10 060 9801
1300	VT1300	10-15	10 060 9351	610	SM610	98-99	10 060 9221
1300	VTX1300	03-09	10 060 9351	610	SM610 S	00-01	10 060 9221
1500	GL1500 Gold Wing	88-03	10 060 9501	610	SM610 S ie	06-08	10 060 9221
1800	GL1800 Gold Wing	01-15	10 060 9351	610	TE610 E Enduro	98-01	10 060 9221
1800	NRX1800 Valkyrie Rune	04-05	10 060 9351	610	TE610 E LT	00	10 060 9221
1800	VTX1800	02-08	10 060 9351	610	TE610 ie	06-08	10 060 9221
HUSABERG				630	SM630 IE	10	10 060 9801
250	FE250	13	10 060 9601	630	SMR630	11	10 060 9801
250	FE250	14	10 060 9591	630	SMS630	11	10 060 9801
350	FE350	13	10 060 9591	630	TE630	11	10 060 9801
390	FE390 Enduro	10-12	10 060 9601	630	TE630 IE	10	10 060 9801
450	FC450	04-06	10 060 9211	900	900 Nuda-R	11-14	10 060 9691
450	FE450 Enduro	04-14	10 060 9601	HYO-SUNG			
450	FS450	04-08	10 060 9211	125-250 (Tutti - All Models)		97-11	10 060 9061
450	FX450 Cross Country	10-11	10 060 9601	ITALJET			
501	FE501	13-14	10 060 9601	125	125 Dragster	06	10 060 9041
550	FC550	04-06	10 060 9211	125	125 Torpedo	98-99	10 060 9031
550	FE550	04-08	10 060 9211	125	125 Torpedo (Leader)	00-03	10 060 9041
550	FS550	04-08	10 060 9211	125	125/150 Jet Set	01-03	10 060 9041
570	FE570 Enduro	09-12	10 060 9601	150	150 Torpedo (Leader)	00-03	10 060 9041
650	FE650	04-08	10 060 9211	250	250 Dragster	06	10 060 9041
650	FS650	04-08	10 060 9211	KAWASAKI			
700	FS570 Supermoto	10-11	10 060 9601	110	KLX110	02-15	10 060 9191
HUSQVARNA				110	KSR110	03-08	10 060 9191
250	FC250	14-15	10 060 9591	125	BN125 Eliminator	98-09	10 060 9191
250	FE250	14-15	10 060 9591	125	KH125	03-06	10 060 9050
250	SM250 R	07	10 060 9221	125	KLX125	03-06	10 060 9050
250	TC250	08	10 060 9801	125	KLX125-D-Tracker	10-14	10 060 9191
250	TC250	09-15	10 060 9521	140	KLX140	08-15	10 060 9191
250	TC250	02-07	10 060 9221	200	Z200 A1-A6	77-83	10 060 9410
250	TC250 R	13	10 060 9521	250	BJ250 A2,A3,C2 Estrella 250	94-00	10 060 9410
250	TE250	10-14	10 060 9521	250	EL250	88-03	10 060 9531
250	TE250	02-07	10 060 9221	250	EX250R Ninja	08-15	10 060 9531
250	TE250	08-09	10 060 9801	250	GPX250R Ninja	88-05	10 060 9531
250	TE250 Meo Replica	11	10 060 9521	250	GPZ250R Ninja	86-87	10 060 9531
250	TE250 R	13	10 060 9521	250	KL250 (KLR250)	77-05	10 060 9410
250	TXC250	10-14	10 060 9521	250	KL250 Super Sherpa	09	10 060 9191
250	TXC250	08-09	10 060 9801	250	KL250 Super Sherpa	00-03	10 060 9191
250	TXC250 R	13	10 060 9521	250	KLX250	06-07	10 060 9191
310	TE310	11-14	10 060 9521	250	KLX250	90-97	10 060 9191
310	TE310	09-10	10 060 9801	250	KX250 F	04-15	10 060 9571
310	TE310 R	13	10 060 9521	250	KZ250	83	10 060 9410
310	TXC310 R	11-14	10 060 9521	250	KZ250	80-81	10 060 9410
350	FC350	15	10 060 9591	250	Z250 C1,C2,G1,G2,LTD	81-83	10 060 9410
350	FE350	14-15	10 060 9591	250	ZZR250	90-93	10 060 9531
410	TE410 E	98-01	10 060 9221	250	ZZR250	98-02	10 060 9531
449	SMR449	11-12	10 060 9781	300	J300	14-15	10 060 9480
449	TC449	11-14	10 060 9781	300	J300 SE	14-15	10 060 9480
449	TE449	11-14	10 060 9781	300	KLX300	96-07	10 060 9191
450	FE450	14-15	10 060 9601	300	Ninja 300	13-15	10 060 9501
450	SM450 R	04-07	10 060 9221	400	KLX400	03	10 060 9621
450	SM450 R-RR	08-10	10 060 9801	400	Z400	74-83	10 060 9531
450	TC450	02-07	10 060 9221	400	ZR400 (Z400F)	83-85	10 060 9531
450	TC450	08-10	10 060 9801	400	ZX400	84-87	10 060 9531
450	TE450	02-07	10 060 9221	400	ZX400 (ZX-4)	88-02	10 060 9501
450	TE450	08-10	10 060 9801	440	KZ440	80-83	10 060 9531
450	TXC450	08-11	10 060 9801	440	Z440	80-85	10 060 9531
501	FE501	14-15	10 060 9601	450	EN450 A1-A6 (454 LTD)	85-90	10 060 9241
510	SM510 R	05-07	10 060 9221	450	KLX450 R	08-14	10 060 9191
510	SM510 R	08-10	10 060 9801	450	KX450 F	06-15	10 060 9191

CC	MODELLO - MODEL	ANNO YEAR	NYP SO	CC	MODELLO - MODEL	ANNO YEAR	NYP SO
500	EN500	03-06	10 060 9351	900	ZL900 Eliminator	85-86	10 060 9531
500	EN500	07-09	10 060 9501	900	ZX900 (GPZ900R) Ninja	84-96	10 060 9531
500	EN500	90-02	10 060 9501	900	ZX900 (ZX-9R)	94-01	10 060 9501
500	ER-5	99	10 060 9501	900	ZX900 F1,F2 Ninja (ZX-9R)	02-03	10 060 9351
500	ER500	96-06	10 060 9501	1000	KLV1000	04-06	10 060 9511
500	EX500 Ninja 500R	04-06	10 060 9351	1000	KLZ1000 Versys	12-15	10 060 9501
500	EX500 Ninja 500R	07-09	10 060 9501	1000	Z1000	81-83	10 060 9531
500	GPZ500 S	03	10 060 9351	1000	Z1000 A1,A2,A3,A6F (ZR1000)	03-06	10 060 9351
500	GPZ500 S	87-89	10 060 9241	1000	Z1000 B7F,B8F (ZR1000)	07-15	10 060 9501
500	GPZ500 S	90-02	10 060 9501	1000	GPZ1000 (GTR1000)	86-06	10 060 9531
500	KLE500	03-05	10 060 9351	1000	ZL1000 Eliminator	87-88	10 060 9531
500	KLE500	06-07	10 060 9501	1000	ZX1000 (GPZ1000RX)	86-89	10 060 9531
500	KLE500	91-02	10 060 9501	1000	ZX1000 (ZX10 Ninja)	88-90	10 060 9531
500	Z500	79-81	10 060 9531	1000	ZX1000 Ninja 1000	11-15	10 060 9501
500	ZZR500	90-96	10 060 9501	1000	ZX-10R Ninja	06-15	10 060 9501
550	KZ550	80-84	10 060 9531	1000	ZX-10R Ninja	04-05	10 060 9351
550	Z550	79-01	10 060 9531	1100	KZ1100	81-05	10 060 9531
550	ZR550 (Z550F)	80-83	10 060 9531	1100	Z1100	81-86	10 060 9531
550	ZR550 Zephyr	91-00	10 060 9531	1100	ZN1100	84-85	10 060 9531
550	ZX550 (GPZ550)	82-92	10 060 9531	1100	ZR1100 Zephyr	91-00	10 060 9531
600	KL600 A1,B1-B4 (KLR600)	84-90	10 060 9410	1100	ZX1100 (GPZ1100)	81-85	10 060 9531
600	ZL600	86-87	10 060 9531	1100	ZX1100 (GPZ1100)	95-97	10 060 9531
600	ZL600 Eliminator	95-98	10 060 9531	1100	ZX1100 (ZZ-R1100)	90-01	10 060 9531
600	ZX600 (GPX600R)	88-00	10 060 9531	1200	ZG1200 Voyager XIII	89-03	10 060 9531
600	ZX600 (GPZ600R)	85-89	10 060 9531	1200	ZRX1200	01-06	10 060 9531
600	ZX600 (ZX6-R Ninja)	07-13	10 060 9501	1200	ZRX1200 Daeg	09	10 060 9531
600	ZX600 (ZX6-R Ninja)	02-06	10 060 9351	1200	ZX-12R Ninja	00-05	10 060 9351
600	ZX600 (ZX6-R Ninja)	95-01	10 060 9501	1200	ZZ-R1200 (ZX1200)	02-05	10 060 9531
600	ZX600 (ZZR600)	02-04	10 060 9351	1400	ZG1400 (GTR1400)	08-15	10 060 9501
600	ZX600 (ZZR600)	90-01	10 060 9501	1400	ZX-14 Ninja (ZX1400)	06-15	10 060 9501
636	ZX636 (ZX6-R Ninja 636)-Abs	13-15	10 060 9501	1400	ZZR1400 (ZX1400)	06-13	10 060 9501
636	ZX636 (ZX6-R Ninja 636)	02-06	10 060 9351	1500	VN1500	87-98	10 060 9501
650	EN650	15	10 060 9501	1500	VN1500	99-06	10 060 9351
650	ER-6f	06	10 060 9351	1500	VN1500 L1 Nomad	00	10 060 9501
650	ER-6f A7F,A8F,B7F,B8F (EX650)	07-14	10 060 9501	1500	VN1500 L1H Classic Tourer	98-00	10 060 9501
650	ER-6n	07-14	10 060 9501	1500	VN1500 N7F,N8F Classic	07-08	10 060 9501
650	ER-6n A6F,B6F (ER650)	06	10 060 9351	1600	VN1600	03-06	10 060 9351
650	EX650 Ninja 650R	06-15	10 060 9501	1600	VN1600	07-08	10 060 9501
650	KL650 (KLR650)	87-15	10 060 9410	1700	VN1700	09-15	10 060 9501
650	KL650 (KLR650)	95-03	10 060 9410	2000	VN2000 Vulcan	04-07	10 060 9351
650	KL650 Tengai (KLR650)	89-92	10 060 9410	2000	VN2000 Vulcan	08-10	10 060 9501
650	KLE650 Versys	08-14	10 060 9501	KTM			
650	KLX650 (KLX650 R)	93-96	10 060 9410	125	125 Duke	11-15	10 060 9211
650	KLX650 C1-C5	93-97	10 060 9410	125	125 RC	14-15	10 060 9211
650	KLX650 R	93-01	10 060 9410	200	200 Duke	12-16	10 060 9211
650	KR650	93	10 060 9531	200	200 RC	14-16	10 060 9211
650	KZ650	78-80	10 060 9531	250	250 EXC Racing (1°filtro -1st filter)	03-06	10 060 9211
650	W650	99-05	10 060 9351	250	250 EXC Racing (2°filtro - 2nd filter)	03-06	10 060 9541
650	Z650	77-83	10 060 9531	250	250 EXC-F	07-12	10 060 9601
750	KZ750	80-84	10 060 9531	250	250 EXC-F	13-15	10 060 9591
750	VN750 Vulcan	04-06	10 060 9351	250	250 EXC-F Six Days	13-15	10 060 9591
750	VN750 Vulcan	84-98	10 060 9241	250	250 Freeride R	15	10 060 9591
750	VN750 Vulcan	99-03	10 060 9501	250	250 SX-F	05-12	10 060 9601
750	Z750	04-06	10 060 9351	250	250 SX-F	13-15	10 060 9591
750	Z750	07-12	10 060 9501	250	250 XC-F-XCF-W	07-12	10 060 9601
750	Z750 (GPZ750)	80-96	10 060 9531	250	250 XC-F-XCF-W	13-14	10 060 9591
750	ZR750 Zephyr ZR-7	91-03	10 060 9531	300	300 EXC-F	15	10 060 9591
750	ZX750 (GPX750R)	86-88	10 060 9531	350	350 EXC-F	12-15	10 060 9591
750	ZX750 (GPZ750)-Turbo	83-89	10 060 9531	350	350 Freeride	12-15	10 060 9591
750	ZX750 (ZX-7R)	96-03	10 060 9501	350	350 SX-F	11-15	10 060 9591
750	ZX750 (ZXR750)	91-95	10 060 9501	350	350 XC-F	12-15	10 060 9591
750	ZX750 H1 (ZXR750)	89-	10 060 9501	390	390 Duke	13-16	10 060 9211
750	ZX750 H2 (ZXR750)	90	10 060 9531	390	390 RC	14-16	10 060 9211
800	VN800 Vulcan	02-06	10 060 9351	400	400 EGS (1°filtro -1st filter)		10 060 9211
800	VN800 Vulcan	95-02	10 060 9501	400	400 EGS (2°filtro - 2nd filter)		10 060 9661
800	W800	11-15	10 060 9501	400	400 EXC	08-11	10 060 9591
800	Z800	13-15	10 060 9501	400	400 EXC (1°filtro -1st filter)	06-07	10 060 9211
900	VN900 Vulcan	06-15	10 060 9501	400	400 EXC (2°filtro - 2nd filter)	06-07	10 060 9541
900	Z900	76	10 060 9531				

CC	MODELLO - MODEL	ANNO YEAR	NYP SO	CC	MODELLO - MODEL	ANNO YEAR	NYP SO
400	400 EXE-EXE Super Competition (1°filtro -1st filter)		10 060 9211	690	690 Duke-R (2°filtro - 2nd filter)	12-13	10 060 9211
400	400 SX-MXC-EXC (1°filtro -1st filter)	04-05	10 060 9211	690	690 Duke-R (2°filtro - 2nd filter)	08-11	10 060 9541
400	400 SX-MXC-EXC (2°filtro - 2nd filter)	04-05	10 060 9541	690	690 Enduro-R (1°filtro -1st filter)	08-11	10 060 9211
400	400 XC-W	08-10	10 060 9591	690	690 Enduro-R (2°filtro - 2nd filter)	12-13	10 060 9211
400	400 XC-W (1°filtro -1st filter)	07	10 060 9211	690	690 Enduro-R (2°filtro - 2nd filter)	08-11	10 060 9541
400	400 XC-W (2°filtro - 2nd filter)	07	10 060 9541	690	690 Rally Factory Replica (2°filtro - 2nd filter)	07-08	10 060 9601
400	400/600 All Rotax		10 060 9201	690	690 Rally Factory Replica (2°filtro - 2nd filter)	09-10	10 060 9211
450	450 EXC	12-15	10 060 9601	690	690 SMC (1°filtro -1st filter)	08-11	10 060 9211
450	450 EXC	09-11	10 060 9591	690	690 SMC (2°filtro - 2nd filter)	08-11	10 060 9541
450	450 EXC (1°filtro -1st filter)	07	10 060 9211	690	690 SMC R (2°filtro - 2nd filter)	12-13	10 060 9211
450	450 EXC (2°filtro - 2nd filter)	07	10 060 9541	690	690 Supermoto R (1°filtro -1st filter)	07	10 060 9601
450	450 EXC-R	08	10 060 9591	690	690 Supermoto R (1°filtro -1st filter)	08-09	10 060 9211
450	450 SMR	08-12	10 060 9591	690	690 Supermoto R (2°filtro - 2nd filter)	07-09	10 060 9541
450	450 SMR	13-14	10 060 9601	950	950 LC8 (Tutti - All Models)	03-11	10 060 9671
450	450 SMR (1°filtro -1st filter)	05-07	10 060 9211	990	990 LC8 (Tutti - All Models)	05-13	10 060 9671
450	450 SMR (2°filtro - 2nd filter)	05-07	10 060 9541	1050	1050 Adventure	15-15	10 060 9671
450	450 SX-EXC-MXC (1°filtro -1st filter)	03-08	10 060 9211	1190	1190 Adventure-R	13-15	10 060 9671
450	450 SX-EXC-MXC (2°filtro - 2nd filter)	03-08	10 060 9541	1190	1190 RC8-R-R Track	09-15	10 060 9671
450	450 SX-F	07-12	10 060 9591	1290	1290 Super Adventure	14-14	10 060 9671
450	450 SX-F	13-15	10 060 9601	1290	1290 Super Duke R	14-14	10 060 9671
450	450 XC-F	13-15	10 060 9601		KYMCO		
450	450 XC-F-XC-WR	08-10	10 060 9591	125	125 Dink ie Eu3	06-13	10 060 9370
450	450 XC-W	12-15	10 060 9601	125	125 Dink ie	09-13	10 060 9480
450	450 XC-W	10-11	10 060 9591	125	125 Grand Dink Eu2	01-11	10 060 9370
500	500 EXC	12-15	10 060 9601	125	125 Grand Dink S Eu3	08-11	10 060 9370
500	500 XC-W	12-15	10 060 9601	125	125 K-XCT ie	12-13	10 060 9480
505	505 SX-F	08-09	10 060 9591	125	125 Super Dink ie	09	10 060 9480
505	505 XC-F	08-09	10 060 9591	125	125 Venox		10 060 9370
520	520 SX-MXC-EXC (1°filtro -1st filter)	99-02	10 060 9211	125	125i G-Dink ie	12-13	10 060 9370
520	520 SX-MXC-EXC (2°filtro - 2nd filter)	99-02	10 060 9541	125	125i People GT ie	10-13	10 060 9480
525	525 SMR (1°filtro -1st filter)	04-06	10 060 9211	150	150 Grand Dink Eu2	01-11	10 060 9370
525	525 SMR (2°filtro - 2nd filter)	04-06	10 060 9541	150	150 People GT ie	10-11	10 060 9480
525	525 SX-MXC-EXC-XC-XC-W (1°filtro -1st filter)	03-07	10 060 9211	200	200 Dink ie Eu3	06-13	10 060 9370
525	525 SX-MXC-EXC-XC-XC-W (2°filtro - 2nd filter)	03-07	10 060 9541	200	200i Dinktown ie Abs	10-13	10 060 9480
530	530 EXC	08-11	10 060 9591	200	200i People Gt	10-13	10 060 9480
530	530 XC	08-10	10 060 9591	200	200i Yager GT	10	10 060 9370
540	540 SXS (1°filtro -1st filter)		10 060 9211	300	300i Dinktown ie	09-13	10 060 9480
540	540 SXS (2°filtro - 2nd filter)		10 060 9541	300	300i Dinktown ie Abs	09-13	10 060 9480
560	560 SMR (1°filtro -1st filter)	07	10 060 9211	300	300i K-XCT ie	12-13	10 060 9480
560	560 SMR (2°filtro - 2nd filter)	07	10 060 9541	300	300i People GT ie	10-13	10 060 9480
620	620 Duke (1°filtro -1st filter)		10 060 9211	400	400 Xciting i	12-14	10 060 9880
620	620 Duke (2°filtro - 2nd filter)		10 060 9661	500	500 Xciting	05-09	10 060 9081
620	620 EGS (1°filtro -1st filter)		10 060 9211	500	500 Xciting RI	10-13	10 060 9081
620	620 EGS (2°filtro - 2nd filter)		10 060 9661	700	700i MyRoad	11-13	10 060 9081
620	620 EXE (1°filtro -1st filter)		10 060 9211		LIGIER		
620	620 LSK (1°filtro -1st filter)		10 060 9211	500	Tutte (Motore Lombardini LDW502)	UFI	10 060 9140
620	620 LSK (2°filtro - 2nd filter)		10 060 9661	500	Tutte (Motore Lombardini LDW523)	UFI	10 060 9140
625	625 SMC (1°filtro -1st filter)	04-05	10 060 9211		LML		
625	625 SMC (2°filtro - 2nd filter)	04-05	10 060 9661	125	125/150 Star 4T	09-13	10 060 9470
625	625 SXC (1°filtro -1st filter)	03-05	10 060 9211		MALAGUTI		
625	625 SXC (2°filtro - 2nd filter)	05	10 060 9661	125	125 Madison 3 (Piaggio)	06-11	10 060 9041
625	625 SXC (2°filtro - 2nd filter)	03-04	10 060 9541	180	180 R Madison	01-02	10 060 9041
640	640 Duke (1°filtro -1st filter)	99-06	10 060 9211	200	200 F12 Phantom Max	04-05	10 060 9041
640	640 Duke (2°filtro - 2nd filter)	99-06	10 060 9661	200	200 S Madison-Rst	02-03	10 060 9041
640	640 LC4 (1°filtro -1st filter)		10 060 9211	250	250 F12 Phantom Max	04-05	10 060 9041
640	640 LC4 (2°filtro - 2nd filter)		10 060 9661	250	250 Madison S-RS-Rst3-3 IE	04-11	10 060 9041
660	660 Rally E Factory Replica	06-07	10 060 9211	500	500 Spider Max-GT-RS	04-11	10 060 9071
660	660 Rally E Factory Replica (1°filtro -1st filter)	06-07	10 060 9661		MBK		
660	660 Rally E Factory Replica (2°filtro - 2nd filter)	06-07	10 060 9541	125	125 Citycruiser	07-11	10 060 9380
660	660 SMC (1°filtro -1st filter)	04-05	10 060 9211	125	125 Cityliner	07-13	10 060 9380
660	660 SMC (2°filtro - 2nd filter)	04-05	10 060 9541	125	125 Skycruiser	06-13	10 060 9380
660	660 Supermoto (1°filtro -1st filter)	02-03	10 060 9211		MICRO-CAR		
660	660 Supermoto (2°filtro - 2nd filter)	02-03	10 060 9541	505	Tutte (Motore Lombardini LDW502)		
690	690 Duke-R (1°filtro -1st filter)	08-13	10 060 9211		MOTO GUZZI		
				125	125 2C 4T	79-81	10 060 9121
				250	250 Quattro-254-Sport-304 4T		10 060 9121

CC	MODELLO - MODEL	ANNO YEAR	NYP SO	CC	MODELLO - MODEL	ANNO YEAR	NYP SO
350	350 Falco	UFI 01/91->	10 060 9180	125	Beverly	01-13	10 060 9041
350	350 Nevada/Nevada Club	UFI 05/88->	10 060 9180	125	Carnaby	07-12	10 060 9041
350	350 NTX	UFI 05/88->	10 060 9180	125	Fly	05-13	10 060 9041
350	V35 tutti	UFI ->04/88	10 060 9420	125	GTX Super Hexagon	01-03	10 060 9041
350	V35 tutti	UFI 05/88->	10 060 9180	125	Liberty	00-14	10 060 9041
500	V50 tutti	UFI ->04/88	10 060 9420	125	Liberty	97-00	10 060 9031
500	V50 tutti	UFI 05/88->	10 060 9180	125	LX-4 Hexagon	98-99	10 060 9031
650	V650 tutti	UFI ->04/88	10 060 9420	125	MP3	07-14	10 060 9041
650	V650 tutti	UFI 05/88->	10 060 9180	125	Sfera FL 4T	95-97	10 060 9031
750	750 NTX	UFI	10 060 9180	125	Skipper ST	00-05	10 060 9041
750	750 S3	75	10 060 9121	125	Typhoon 4T	10-12	10 060 9041
750	750 SP	UFI	10 060 9180	125	Vespa ET4	96-99	10 060 9031
750	750 Strada	UFI	10 060 9180	125	Vespa ET4-GT-GTS-GTV-LX-LXV-S	00-14	10 060 9041
750	750 Targa	UFI	10 060 9180	125	X10	12-13	10 060 9041
750	Breva V750 IE 35KW	UFI 01/03->	10 060 9180	125	X7	08-12	10 060 9041
750	Nevada 750	UFI 91-03	10 060 9180	125	X8 Premium-Street	05-07	10 060 9041
750	Nevada 750 Club	UFI 98-03	10 060 9180	125	X9	01-07	10 060 9041
750	Nevada 750 IE 35KW	UFI 04->	10 060 9180	125	X-Evo	07-08	10 060 9041
750	Nevada Classic 750 IE 35KW	UFI 04->	10 060 9180	125	Zip	02-06	10 060 9041
750	Nevada Touring 750 IE 35KW	UFI 04->	10 060 9180	150	Fly-LEM-DT	05-13	10 060 9041
750	V75	UFI	10 060 9180	150	Liberty	99-14	10 060 9041
750	V75 Polizia (750)	UFI	10 060 9180	150	Skipper ST	00-05	10 060 9041
850	850 Breva-Norge-Griso	06-11	10 060 9151	150	Vespa ET4-LX-LXV-S	00-14	10 060 9041
850	850 Le Mans I,II,III-T3-California	75-83	10 060 9121	150	X8	06-08	10 060 9041
850	850 T3,T4,T5	75-88	10 060 9121	180	GTX Super Hexagon	01	10 060 9041
850	850 T5	89-05	10 060 9151	180	X9 Amalfi	01-03	10 060 9041
940	940 Bellagio	07-12	10 060 9151	200	Beverly GT-Rst	01-03	10 060 9041
1000	1000 California II-III	82-93	10 060 9121	200	Carnaby	07-10	10 060 9041
1000	1000 Daytona	92-93	10 060 9121	200	Liberty Rst-Sport	04-09	10 060 9041
1000	1000 Daytona-RS	94-01	10 060 9151	200	Vespa GT	04-09	10 060 9041
1000	1000 Le Mans V-IV	84-92	10 060 9121	200	X8	05-06	10 060 9041
1000	1000 Mille GT	87-94	10 060 9121	200	X9	02-03	10 060 9041
1000	1000 Quota	89-93	10 060 9121	200	X9 Evolution	03-04	10 060 9041
1000	1000 Quota ie	94-97	10 060 9151	250	Beverly	04-09	10 060 9041
1000	1000 S	90-93	10 060 9121	250	Carnaby	08-09	10 060 9041
1000	1000 SP-SP2-SP3	78-96	10 060 9121	250	MP3	06-10	10 060 9041
1000	1000 V10 Centauro	97-01	10 060 9151	250	Vespa GT-GTS-GTV	05-11	10 060 9041
1000	1000 V1000 G5	78-85	10 060 9121	250	X7	08-09	10 060 9041
1000	1000 V1000 I Convert	75-84	10 060 9121	250	X8	05-08	10 060 9041
1000	MGS-01 Corsa	05-11	10 060 9151	250	X9	00-07	10 060 9041
1100	1100 V11-Corsa-Stone-Sport-Quota-Griso	94-09	10 060 9151	250	X-Evo	07-08	10 060 9041
1100	1100 California	94-13	10 060 9151	300	Beverly Rst 4T-4V i.e.	09-13	10 060 9041
1200	1200 Breva-Griso 8V-Norge-Sport-Stelvio	06-14	10 060 9151	300	Carnaby Cruiser i.e.	09-13	10 060 9041
MUZ				300	MP3	10-14	10 060 9041
125	125 RT	00-08	10 060 9201	300	Vespa GTS-GTV	08-14	10 060 9041
125	125 SM	00-08	10 060 9201	300	X7	09-12	10 060 9041
125	125 SX	00-08	10 060 9201	350	Beverly	11-14	10 060 9801
500	500 (Tutti - All Models)	91-98	10 060 9201	350	X10	12-14	10 060 9041
660	660 (Tutti - All Models)	94-00	10 060 9290	400	Beverly	06-09	10 060 9071
MV AGUSTA				400	MP3	07-12	10 060 9071
750	F4 S 750 1+1 EVO 3	03	10 060 9791	400	X8	06-08	10 060 9071
910	910 Brutale R-S	05-08	10 060 9791	400	X-Evo	07-12	10 060 9071
1000	Brutale 1000	01-05	10 060 9791	420	Ape Car Diesel	UFI	10 060 9010
1000	F4 1000 (Tutti - All Models)	00-07	10 060 9791	420	Ape Max Diesel	UFI 86-96	10 060 9010
1078	Brutale 1078RR	09	10 060 9351	420	Ape Poker	UFI 93->	10 060 9010
1078	F4 R 312	08-09	10 060 9351	420	Ape Poker Diesel	UFI	10 060 9010
PEUGEOT				420	Ape TM D LCS (Motore Lombardini)	UFI	10 060 9010
125	125 (Tutti - All Models)	99-14	10 060 9021	420	Ape TM P703 Diesel (421)	UFI	10 060 9010
150	Elyseo	01-03	10 060 9021	420	Ape TM P703/V Diesel	UFI 87-01	10 060 9010
150	Elystar	03-10	10 060 9021	500	Beverly	03-13	10 060 9071
150	Looxor	03-04	10 060 9041	500	MP3	11-14	10 060 9071
250	(Tutti - All Models)	07-12	10 060 9041	500	X10	12-14	10 060 9071
300	(Tutti - All Models)	11-13	10 060 9041	500	X9	02-10	10 060 9071
400	(Tutti - All Models)	07-13	10 060 9071	500	AL 500 Diesel (Lombardini LDW502)	UFI	10 060 9140
500	(Tutti - All Models)	07-13	10 060 9071	500	PK 500 Diesel (Lombardini LDW502)	UFI	10 060 9140
PIAGGIO				700	Quargo Diesel (Lombardini LDW702)	UFI	10 060 9140
125	B125 City Slicker	02	10 060 9041	SACHS			
				125	125 Roadster	98-01	10 060 9290

CC	MODELLO - MODEL	ANNO YEAR	NYP SO	CC	MODELLO - MODEL	ANNO YEAR	NYP SO
SHERCO				450	RM-Z450	05-15	10 060 9571
250	SE 2.5i F	08-13	10 060 9781	500	DR500	81-84	10 060 9651
250	SX 2.5i F	10	10 060 9781	500	GS500	88-10	10 060 9271
300	SE 3.0i F	10-13	10 060 9781	500	SP500	81-83	10 060 9651
450	SE 4.5i F	04-13	10 060 9781	550	GS550	77-86	10 060 9271
450	SM 4.5i F	04-10	10 060 9781	550	GSX550	83-87	10 060 9271
510	SE 5.1i F	04-13	10 060 9781	600	DR600	85-91	10 060 9651
510	SM 5.1i F	04-10	10 060 9781	600	GSF600 Bandit	95-04	10 060 9511
SUZUKI				600	GSR600-Yoshimura	06-10	10 060 9511
100	DR100	83-90	10 060 9061	600	GSX600	88-06	10 060 9511
100	SP100	83	10 060 9061	600	GSX-R600	92-93	10 060 9511
110	DR-Z110	03-05	10 060 9191	600	GSX-R600	97-15	10 060 9511
125	AN125	96-00	10 060 9061	600	RF600	93-97	10 060 9511
125	CS125 Roadie	83-87	10 060 9061	600	SP600 F	85	10 060 9651
125	DR125	80-85	10 060 9061	600	VS600	95-98	10 060 9511
125	DR125	85-00	10 060 9050	650	AN650 Burgman	02-14	10 060 9511
125	DR125 SM	07-09	10 060 9061	650	DL650 V-Strom	04-15	10 060 9511
125	DR-Z125-L	03-14	10 060 9050	650	DR650	90-14	10 060 9651
125	FL125 Address	07-10	10 060 9571	650	DS650	92-93	10 060 9651
125	GN125	82-83	10 060 9061	650	GR650	83-85	10 060 9271
125	GN125	91-00	10 060 9061	650	GS650	81-84	10 060 9271
125	GS125	79-00	10 060 9061	650	GSF650 Bandit	05-14	10 060 9511
125	GZ125 Marauder	99-10	10 060 9061	650	GSX650	08-15	10 060 9511
125	RV125 Van Van	03-14	10 060 9050	650	LS650 Savage (Belt)	86-09	10 060 9651
125	SP125	82-83	10 060 9061	650	S40 Boulevard (LS650)	05-15	10 060 9651
125	SP125	86-88	10 060 9050	650	SFV650 Gladius (Abs)	09-15	10 060 9511
125	TU125 XT	99	10 060 9061	650	SV650-S	99-10	10 060 9511
125	UC125 Epicuro	99-03	10 060 9061	650	XF650 Freewind	97-02	10 060 9651
125	UE125	01	10 060 9061	650	XN85 Turbo (650cc)	83-86	10 060 9271
125	UH125 Burgman	02-14	10 060 9061	700	GS700 EF,ESF	85	10 060 9271
125	UX125 Sixteen	08-14	10 060 9061	750	DR750 Big	88-89	10 060 9651
125	VL125 Intruder LC	00-06	10 060 9450	750	GS750	77-83	10 060 9271
150	AN150	95-00	10 060 9061	750	GSR750 (Abs)	11-14	10 060 9511
150	UC150 Epicuro	99-03	10 060 9061	750	GSX750	79-89	10 060 9271
150	UE150	01	10 060 9061	750	GSX750	89-06	10 060 9511
150	UX150 Sixteen	08-14	10 060 9061	750	GSX-R750	92-15	10 060 9511
200	DR200	96-15	10 060 9050	750	GSX-R750 Sling Shot	88-89	10 060 9511
200	DR200	86-91	10 060 9050	750	GSX-S750	15	10 060 9511
200	UH200 Burgman	07-14	10 060 9061	750	VS750 Intruder	87-91	10 060 9511
250	AN250 Burgman	99-07	10 060 9050	800	C50 Boulevard	05-15	10 060 9511
250	DR250	82-99	10 060 9450	800	C800 Intruder (VL800 Intruder)	05-15	10 060 9511
250	DR-Z250	01-07	10 060 9450	800	DR800	88-00	10 060 9651
250	GN250	82-00	10 060 9450	800	M50 Boulevard	05-15	10 060 9511
250	GS250 TT, TX	79-81	10 060 9271	800	M800 Intruder (VZ800 Marauder)	05-14	10 060 9511
250	GSX1250	10-13	10 060 9511	800	S50 Boulevard	05-09	10 060 9511
250	GSX250-Katana	80-84	10 060 9271	800	VL800 Intruder-Volusia	01-09	10 060 9511
250	GSX-R250 RCH,RH,CJ,CK	87-89	10 060 9271	800	VS800 Intruder	92-09	10 060 9511
250	GW250 Inazuma	12-14	10 060 9511	800	VX800	90-97	10 060 9511
250	GZ250 Marauder	99-10	10 060 9450	800	VZ800 Marauder	97-11	10 060 9511
250	RM-Z250	04-15	10 060 9571	850	GS850 GN,GT,GX	79-85	10 060 9271
250	SP250	82-85	10 060 9450	900	C90 Boulevard	05-15	10 060 9511
250	TU250 X	09-15	10 060 9450	900	RF900	94-00	10 060 9511
250	TU250 X	98-00	10 060 9450	1000	DL1000 V-Strom	02-15	10 060 9511
250	VL250 Intruder LC	00-04	10 060 9450	1000	GS1000	78-84	10 060 9271
300	GS300 LZ,LD,LF	82-85	10 060 9271	1000	GSX1000 Katana	82-84	10 060 9271
350	DR350	90-00	10 060 9450	1000	GSX-R1000	01-15	10 060 9511
400	AN400 Burgman	07-14	10 060 9061	1000	SV1000-S	03-07	10 060 9511
400	AN400 Burgman	99-06	10 060 9050	1000	TL1000 R-S	97-02	10 060 9511
400	DR400	80-83	10 060 9450	1100	GS1100	80-86	10 060 9271
400	DR-Z400	00-15	10 060 9621	1100	GSX1100	88-96	10 060 9511
400	GN400	80-82	10 060 9450	1100	GSX1100-Katana	80-87	10 060 9271
400	GS400 B,C,EC,EN	77-79	10 060 9271	1100	GSX-R1100	86-97	10 060 9511
400	GSF400 Bandit	90-95	10 060 9271	1150	GS1150	84-86	10 060 9271
400	GSX400	81-87	10 060 9271	1200	GSF1200 Bandit	96-06	10 060 9511
400	GSX400 (2 Cilindri)	80-85	10 060 9271	1200	GSX1200 Inazuma	99-00	10 060 9511
400	SP400	79-82	10 060 9450	1250	GSF1250 Bandit	07-14	10 060 9511
425	GS425 N,EL,EN	79-80	10 060 9271	1300	GSX1300 B-King	08-12	10 060 9511
450	GS450	80-88	10 060 9271	1300	GSX-R1300 R Hayabusa	99-15	10 060 9511
450	RMX450	10-13	10 060 9571	1365	S83 Boulevard	05-10	10 060 9511



CC	MODELLO - MODEL	ANNO YEAR	NYP SO	CC	MODELLO - MODEL	ANNO YEAR	NYP SO
1400	GSX1400	01-06	10 060 9511	955	955i Speed Triple	99-01	10 060 9751
1400	GV1400	87-88	10 060 9511	955	955i Speed Triple (VIN 141872 a 210444)	02-04	10 060 9751
1400	VS1400 Intruder	87-09	10 060 9511	1000	1000 Daytona	91-95	10 060 9531
1500	VL1500 LC Intruder	98-09	10 060 9511	1050	1050 Speed Triple (R)-Sprint GT-Tiger	06-14	10 060 9351
1500	VZ1500 Boulevard-Intruder	09-15	10 060 9511	1200	1200 Daytona	93-97	10 060 9531
1600	M95 Boulevard	05	10 060 9351	1200	1200 Tiger Explorer (xc)-Trophy	12-14	10 060 9351
1600	VZ1600 Marauder	04-05	10 060 9351	1200	1200 Trophy	91-03	10 060 9531
1800	M109R Boulevard	06-15	10 060 9511	1600	1600 Thunderbird	09-14	10 060 9351
1800	VLR1800 Intruder-Boulevard	08-13	10 060 9511	1700	1700 Thunderbird	10-14	10 060 9351
1800	VZR1800 Intruder	06-13	10 060 9511	2300	Rocket III	04-14	10 060 9351
SYM				YAMAHA			
400	400i Max	11-13	10 060 9050	125	VP125 X-City	07-13	10 060 9380
TM RACING				125	WR125 R-X	09-14	10 060 9380
250	250 4T	07-12	10 060 9380	125	XV125 S Virago	97-01	10 060 9290
450	450 4T	07-11	10 060 9380	125	XVS125 Drag Star	00-04	10 060 9290
530	530 4T	07-11	10 060 9380	125	YP125 X-Max	06-15	10 060 9380
660	660 4T	08-09	10 060 9380	125	YZF-R125	08-15	10 060 9380
TRIUMPH				180	XC180	83-85	10 060 9290
50	T509 Speed Triple	97-98	10 060 9751	200	XC200	90-91	10 060 9290
595	T595 Daytona	97-98	10 060 9751	250	SR250	79-96	10 060 9290
600	600 Daytona	03-04	10 060 9751	250	TT250	80-82	10 060 9290
600	600 Speed Four	03-04	10 060 9751	250	TT-R250	00-06	10 060 9380
600	600 Speed Four	05-06	10 060 9351	250	WR250 F-N,P	01-02	10 060 9380
600	600 TT	00-05	10 060 9751	250	XC250 ZCT	87	10 060 9290
650	650 Daytona	05	10 060 9351	250	XS250	78-82	10 060 9641
675	675 Daytona-R	06-15	10 060 9351	250	XT250	80-92	10 060 9290
675	675 Street Triple-R	08-15	10 060 9351	250	XV250	88-15	10 060 9290
750	750 Daytona	91-95	10 060 9531	250	XVS250 Drag Star	01-04	10 060 9290
750	750 Speed Triple	97	10 060 9531	250	YZ250 F-N,P	01-02	10 060 9380
750	750 Thunderbird	95	10 060 9531	300	YZF-R3	15	10 060 9351
750	750 Trident	91-98	10 060 9531	350	BW350 T	87	10 060 9290
800	800 America	02-04	10 060 9751	400	FZ400		10 060 9641
800	800 America	05-06	10 060 9351	400	FZR400 RR	90-94	10 060 9501
800	800 Bonneville	01-04	10 060 9751	400	SR400	14-15	10 060 9290
800	800 Bonneville T100	03-04	10 060 9751	400	WR400 F	99-01	10 060 9380
800	800 Bonneville-T100	05-06	10 060 9351	400	XJ400	82	10 060 9641
800	800 Speedmaster	05	10 060 9351	400	XJR400	92-98	10 060 9501
800	800 Speedmaster	03-04	10 060 9751	400	XS400	77-83	10 060 9641
800	800 Tiger-XC	11-14	10 060 9351	400	XT400	81-84	10 060 9290
865	865 America-LT	07-14	10 060 9351	400	YP400 Majesty	04-14	10 060 9050
865	865 Bonneville	07-14	10 060 9351	400	YP400 X-Max	13-15	10 060 9050
865	865 Scrambler	07-14	10 060 9351	400	YZ400 F-K,L	98-99	10 060 9380
865	865 Speedmaster	07-14	10 060 9351	426	WR426 F	01-02	10 060 9380
865	865 Thruxton	07-14	10 060 9351	426	YZ426 F	00-02	10 060 9380
900	900 Adventurer	95-01	10 060 9531	500	SR500	78-00	10 060 9290
900	900 Bonneville T100	06	10 060 9351	500	TMAX 500 (Abs)	01-11	10 060 9081
900	900 Daytona	94-97	10 060 9531	500	TT500	77-80	10 060 9290
900	900 Legend TT	99-01	10 060 9531	500	XT500	76-85	10 060 9290
900	900 Scrambler	06	10 060 9351	500	XV500 Virago	83	10 060 9290
900	900 Speed Triple	94-96	10 060 9531	530	TMAX 530 (Abs)	12-15	10 060 9081
900	900 Speedmaster	06	10 060 9351	535	XV535 Virago	82-02	10 060 9290
900	900 Sprint Sports	95-98	10 060 9531	550	XJ550	81-85	10 060 9641
900	900 Thruxton	04-06	10 060 9351	550	XZ550	82-83	10 060 9290
900	900 Thunderbird	95-03	10 060 9531	600	FJ600	84-85	10 060 9641
900	900 Thunderbolt	96	10 060 9531	600	FZ600	86-89	10 060 9641
900	900 Tiger	91-00	10 060 9531	600	FZ6-Fazer	04-06	10 060 9501
900	900 Trident	91-98	10 060 9531	600	FZ6-Fazer (Abs)	07-10	10 060 9351
900	900 Trophy	91-01	10 060 9531	600	FZR600	89-90	10 060 9641
955	955 Sprint RS	01	10 060 9751	600	FZR600	91-99	10 060 9501
955	955 Sprint RS (VIN 139277 >)	02-04	10 060 9751	600	FZS600 Fazer	98-03	10 060 9081
955	955 Sprint ST	01	10 060 9751	600	SRX600	86-89	10 060 9290
955	955 Sprint ST	05	10 060 9351	600	TT600	83-92	10 060 9290
955	955 Sprint ST (VIN 139277 a 208166)	02-04	10 060 9751	600	TT600 RE	04	10 060 9290
955	955 Tiger	01-04	10 060 9751	600	XJ600	84-85	10 060 9641
955	955 Tiger	05-06	10 060 9351	600	XJ600	86-91	10 060 9641
955	955i Daytona	05-06	10 060 9351	600	XJ600	91-03	10 060 9501
955	955i Daytona	99-01	10 060 9751	600	XJ6-Diversion-SP (Abs)	09-15	10 060 9351
955	955i Daytona (VIN 132513 >)	02-04	10 060 9751	600	XS600	92	10 060 9501
955	955i Speed Triple	05	10 060 9351				

CC	MODELLO - MODEL	ANNO YEAR	NYP SO	CC	MODELLO - MODEL	ANNO YEAR	NYP SO
600	XS600	95	10 060 9501	1300	XVZ13	85-93	10 060 9811
600	XT600 E-Z Tenere	83-05	10 060 9290	1300	XVZ13	96-13	10 060 9501
600	YX600 C-S,T,U,W,A Radian	86-90	10 060 9641	1600	XV1600	99-04	10 060 9501
600	YZF600 Thundercat	95-03	10 060 9501	1700	VMX1700 V-Max	09-15	10 060 9501
600	YZF-R6	06-15	10 060 9351	1700	XV1700	02-15	10 060 9501
600	YZF-R6	99-05	10 060 9501	1900	XV1900	06-10	10 060 9501
650	XJ650-Turbo	80-84	10 060 9641	1900	XV1900	11-15	10 060 9351
650	XVS650 A Drag Star Classic	98-05	10 060 9290				
650	XVS650 Drag Star	97-04	10 060 9290				
660	MT-03	06-12	10 060 9290				
660	SZR660	96-98	10 060 9290				
660	XT660 R-X SuperMotard-Z Tenere	04-15	10 060 9290				
660	XTZ660 Tenere	91-99	10 060 9290				
700	FZ-07 (Abs)	15	10 060 9351				
700	FZ700 T,TC	87	10 060 9531				
700	MT-07 (Abs)	14-15	10 060 9351				
700	XJ700	85-86	10 060 9641				
700	XV700	84-87	10 060 9290				
700	YZF-R7	99-01	10 060 9501				
750	FZ750 Genesis	85-94	10 060 9531				
750	FZR750 (OW01)	90-92	10 060 9501				
750	FZR750 RA,RB	91-92	10 060 9531				
750	FZX750	98	10 060 9531				
750	FZX750	86-88	10 060 9531				
750	XJ750	81-84	10 060 9641				
750	XS750	77-80	10 060 9811				
750	XTZ750 Super Tenere	90-97	10 060 9290				
750	XV750	81-99	10 060 9290				
750	YZF750	93-98	10 060 9501				
800	FZ8-Fazer	10-15	10 060 9351				
850	TDM850	91-01	10 060 9290				
850	TRX850	95-00	10 060 9290				
850	XS850	80-81	10 060 9811				
900	FJ-09	15	10 060 9351				
900	MT-09-Tracer-SportTracker-StreetRally (Abs)	14-15	10 060 9351				
900	TDM900 (Abs)	02-12	10 060 9290				
900	XJ900	82-93	10 060 9641				
900	XJ900 S Diversion	94-03	10 060 9501				
920	XV920	81-83	10 060 9290				
950	XVS950	09-15	10 060 9351				
1000	FZ1 Fazer (Abs)	06-15	10 060 9351				
1000	FZR1000	91-94	10 060 9501				
1000	FZR1000 Genesis	87-90	10 060 9531				
1000	FZS1000 Fazer	01-05	10 060 9501				
1000	GTS1000	93-00	10 060 9501				
1000	XV1000	81-85	10 060 9290				
1000	XV1000 SE-Virago	83-00	10 060 9290				
1000	YZF1000 Thunder Ace	96-02	10 060 9501				
1000	YZF-R1	07-15	10 060 9351				
1000	YZF-R1	98-06	10 060 9501				
1100	BT1100 Bulldog	02-06	10 060 9290				
1100	FJ1100	84-86	10 060 9531				
1100	XJ1100 J	82	10 060 9811				
1100	XS1100	78-84	10 060 9811				
1100	XVS1100 A Drag Star Classic	99-05	10 060 9290				
1100	XVS1100 Drag Star	99-05	10 060 9290				
1200	FJ1200	86-95	10 060 9531				
1200	VMX1200 V-Max	85-95	10 060 9811				
1200	VMX1200 V-Max	96-07	10 060 9501				
1200	XJR1200	95-98	10 060 9531				
1200	XT1200 Z Super Tenere	10-15	10 060 9351				
1200	XVZ1200	83-86	10 060 9811				
1300	FJR1300	01-12	10 060 9681				
1300	FJR1300	13-15	10 060 9351				
1300	MT-01	05-11	10 060 9501				
1300	XJR1300	99-15	10 060 9531				
1300	XVS1300	11-14	10 060 9351				
1300	XVS1300 Midnight Star	07-10	10 060 9081				



FILTRI CARBURANTE

FUEL FILTERS

10 060 7000



FILTRO BENZINA - FUEL FILTER

Attacco tubo Ø 6-8

(Elemento filtrante in carta)

Pipe attack Ø 6-8

(Paper filter)



10 060 7010



FILTRO BENZINA MIGNON - FUEL FILTER

Attacco tubo Ø 7

Pipe attack Ø 7



10 060 7020



UFI

FILTRO BENZINA - FUEL FILTER

DUCATI: 851 S-Ssl^o-Ss racing I^o- Superbike I^o-Sp/2/3 I^o- Sport Production >92

GUZZI: 1000 Daytona ie • V10 Centauro ie • Gt Sport • 1100 • V11 • Cafè Sport • Le Mans-Sport • ie



10 060 7030



UFI

FILTRO GASOLIO - DIESEL FUEL FILTER

AIXAM: Microcars Serie 3251

BELLIER: Divane 505 D • Vx 550 • S

CARLETTI: 500 SL • Top SL

CASALINI: Sulky • Ydea 505 GLX Diesel

CHATENET: Stella 214 • Passion

GRECAV: Eke • Diesel • E • L • Lm • Lp • XL • XLe Palladium

JDM: Alabiza Base L • Club • Confort L

LIGIER: Diesel • Ambra 162 GL • GLs • Sulky

MICROCAR: Lyra 505 Sprint • Txe • Virgo 505

SAVEL: Spacia 2 Re

TASSO: 505 • C1db Ts • Bingo • Ss • Domino Pick Up • Hola



10 060 7050



UFI

FILTRO GASOLIO - DIESEL FUEL FILTER

420: Tmp 703 Diesel • Poker Diesel

(R.O. 245303)



10 060 7060



UFI

FILTRO BENZINA - FUEL FILTER

BMW: 125-200 C1 • 750 K75 • C-Rt • Rt Kat • S T • Touring • 850 R • Rt abs • 1000 K1 72-74 Kw • Club • abs • 1000 K100 • Basic • Lt • Lt abs

Rs • Rt • 72-74 Kw Rs • Rs Club • Rs abs

1000 K1100 72-74 • Kw • Lt • Lt Se • Rs

1000 R 1100 Gs • Rs • R • Rsc • Rt abs • S

1150 R Gs • 1200 R • C • C Kat • 1200 K • Lt • Rs

CAGIVA: 650 Raptor • V Raptor (Suzuki)

900 Elefant • E • ie Gt • ie Lucky Explorer

900 Gran Canyon ie • 1000 Navigator

Raptor • V Raptor • Xtra Raptor (Suzuki)

DUCATI: 748 Bi Monoposto • R • S • Sp • Sps

750-800 Super Sport ie • 851 • S • Ss II^o

Ss Racing • Ss Super Bike • Sp Sp2-Sp3 II^o

851 Sport Production II^o • 888 Biposto • Sp4

5 • Racing • Strada • 900 M ie Cromo Monster

Dark Monster • Monster S ie • ie Gt-Paso ie

916 • Monster S4-St4 ie Bi Monoposto • Sen-

na • Sp • Sps • Strada • 944 St2 ie 996 Biposto

Two Seater (Usa) • Sps III^o • 998 S • Super Bike

S Super Bike Bostrom (Usa) • 1000 S. Sport ie

TRIUMPH: 900 T 509 Speed Triple • Tiger

955 Daytona • I-Sprint St • Tiger



10 060 7040



UFI

FILTRO GASOLIO - DIESEL FUEL FILTER

420: Tmp 703 Diesel • Poker Diesel

1200: Porter • Lombardini 01-95>

1400: Porter • Lombardini 01-95>

(R.O. 247444)



10 060 7070



FILTRO BENZINA - FUEL FILTER

KYMCO 50: Agility 12"

(R.O. 00159119)



10 060 7080



UFI

FILTRO GASOLIO - DIESEL FUEL FILTER

PIAGGIO 1200: Porter diesel 11





FILTRI BENZINA - FUEL FILTERS				FILTRI GASOLIO - DIESEL FILTERS			
MODELLO MODELS	CC	ANNO YEAR	CODICE CODE	MODELLO MODELS	CC	ANNO YEAR	CODICE CODE
BMW				AIXAM			
C1 K75 • C • Rt • Rt Kat • S • T • Touring	125-200 750		10 060 7060	Microcars Serie 3251			10 060 7030
R • Rt abs K1 72-74 • Kw • Club • abs	850 1000		10 060 7060	BELLIER			
K100 • Basic • Lt • Lt abs • Rs • Rt • 72-74 Kw Rs • Rs • Club • Rs abs	1000		10 060 7060	Divane -D-Vx 550 /S	505		10 060 7030
K1100 72-74 • Kw • Lt • Lt Se • Rs R 1100 Gs • Rs • R • Rsc Rt abs • S	1000		10 060 7060	CARLETTI			
R Gs R • C • C Kat • 1200 K • Lt • Rs	1150 1200		10 060 7060	SL-Top SL	500		10 060 7030
CAGIVA				CASALINI			
Raptor • V Raptor (Suzuki) • 900 Elefant • E ie Gt • le Lucky Explorer	650		10 060 7060	Sulky-Ydea Gix Diesel	505		10 060 7030
Gran Canyon Le Navigator Raptor • V Raptor • Xtra Raptor (Suzuki)	900 1000		10 060 7060	CHATENET			
DAUCATI				Stella 214-Passion			10 060 7030
Bi Monoposto • R • S • Sp • Sps	748		10 060 7060	GRECAV			
Super Sport Le-851 • S • Ss II° • Ss Racing	750-800		10 060 7060	Eke-Diesel-E-L-Lm-Lp-XL-Xle Palladium			10 060 7030
Ss Super Bike Sp Sp2 • Sp3 II° • 851 Sport Production II°	851		10 060 7060	JDM			
Biposto • Sp4 • 5 • Racing-Strada	888		10 060 7060	Alabiza Base L-Club-Confort L			10 060 7030
M Le Cromo Monster Dark • Mon. • Mon. S Le • Le Gt • Paso Le	900		10 060 7060	LIGIER			
Monster S4-St4 Le Bi Monoposto • Senna • Sp • Sps • Strada	916		10 060 7060	Diesel-Ambra 162 GL-GLs-Sulky			10 060 7030
St2 Le Biposto Two Seater (Usa)	944 966		10 060 7060	MICROCAR			
Sps III° S • Super Bike S Super	998		10 060 7060	Lyra Sprint-Txe-Virgo 505	505		10 060 7030
Bike Bostrom (Usa) • S. Sport Le	1000		10 060 7060	PIAGGIO APE			
S-Ssl° • Ss racing I° • Superbike I° • Sp/2/3 I° Sport Production	851	>92	10 060 7020	703 247444 • Tmp Diesel (421) Poker Diesel			10 060 7040
GUZZI				Porter 1,2 Lombardini		01-95>	
Daytona Le V10 Centauro Le • Gt Sport	1000		10 060 7020	Porter 1,4 Lombardini		01-95>	
V11 • Cafe Sport Le Mans • Sport • Le	1100		10 060 7020	PIAGGIO PORTER			
TRIUMPH				Tmp 703 Diesel (421) Con Piaggio 245303			10 060 7050
T 509 Speed Triple • Tiger-955 Daytona • ISprint St • Tiger	900		10 060 7060	PIAGGIO PORTER			
				Porter Autobus 1.2D	1200	11>	10 060 7080
				Porter Furgonato 1.2D	1200	11>	10 060 7080
				Porter Ribaltabile 1.2D	1200	11>	10 060 7080
				Porter Pianale Piatto - Telaio	1200	11>	10 060 7080
				SAVEL			
				Spacia 2 Re			10 060 7030
				TASSO			
				C1db-Ts-Bingo-Ss-Domino Pick Up-Hola	505		10 060 7030

The background of the entire page is a repeating pattern of various automotive and mechanical icons in a light gray color. These icons include a motorcycle, a battery with a lightning bolt, a wrench and screwdriver, a piston, a gear, a tire, a bolt, a nut, a ball joint, a shock absorber, and a steering knuckle.

RMS

YOUR BEST PARTNER

▶ FILTRI OLIO

OIL FILTERS



CODICE CHAMPION CHAMPION CODE	VECCHIO CODICE CHAMPION CHAMPION OLD CODE	CODICE HF HF CODE	CODICE RMS RMS CODE	CODICE CHAMPION CHAMPION CODE	VECCHIO CODICE CHAMPION CHAMPION OLD CODE	CODICE HF HF CODE	CODICE RMS RMS CODE
COF011	X304	HF111	10 060 9325	COF070C	-	HF170	10 060 9715
COF013	X301 - X356	HF113	10 060 9195	COF071B	-	-	10 060 9975
COF016	X319 - X357	HF116	10 060 9525	COF071C	C306	HF171	10 060 9565
COF023	X310	HF123	10 060 9415	COF072C	-	HF172	10 060 9725
COF026	X314	HF126	10 060 9945	COF074C	-	HF174	10 060 9735
COF031	X327	HF131	10 060 9065	COF077	-	HF177	10 060 9745
COF032	X328	HF132	10 060 9055	COF081	X330	HF181	10 060 9035
COF033	X307	HF133	10 060 9275	COF082	-	HF182	10 060 9435
COF036	X319	HF136	10 060 9455	COF083	C320	HF183	10 060 9045
COF037	X308	HF137	10 060 9655	COF084	C316	HF184	10 060 9075
COF038	X301	HF138	10 060 9515	COF085	X325	HF185	10 060 9025
COF039	X345	HF139	10 060 9625	COF086	-	HF186	10 060 9495
COF040	X354	HF140	10 060 9895	COF091	-	HF191	10 060 9755
COF041	-	HF141	10 060 9385	COF100118S	F118	-	10 060 8005
COF042	X348	HF142	10 060 9615	COF100136S	F136	-	10 060 9995
COF043	X313	HF143	10 060 9635	COF100180F	F180	-	10 060 9985
COF044	X306	HF144	10 060 9645	COF102	F302	HF202	10 060 9245
COF045	X302	HF145	10 060 9295	COF104	F308	HF204 HF951	10 060 9355
COF046	X311	HF146	10 060 9815	COF107	X351	HF207	10 060 9575
COF047	F307	HF147 HF985	10 060 9085	COF203	F304 - F306	HF303	10 060 9505
COF048	-	HF148	10 060 9685	COF301	X303 - X315	HF401	10 060 9535
COF051	X305	HF151	10 060 9205	COF451	C305	HF551	10 060 9155
COF052	X312	HF152	10 060 9585	COF452	H302	HF552	10 060 9125
COF053	H301	HF153	10 060 9105	COF453	F310	HF553	10 060 9765
COF054	X337	HF154	10 060 9225	COF454	F305	HF554	10 060 9795
COF055	X320	HF155	10 060 9215	COF456	X347	HF556	10 060 9925
COF056	F303	HF156	10 060 9665	COF461	-	HF561	10 060 9935
COF057	X335	HF157	10 060 9545	COF462	-	HF562	10 060 9375
COF058	X340	HF158	10 060 9675	COF463	-	HF563	10 060 9805
COF060	-	HF160	10 060 9695	COF465	-	HF565	10 060 9775
COF061	X317	HF161	10 060 9175	COF466	-	HF566	10 060 9485
COF063	C301	HF163	10 060 9135	COF468	-	HF568	10 060 9885
COF064	C325	HF164	10 060 9555	COF511	-	HF611	10 060 9785
COF065	-	HF165	10 060 9705	COF531	-	HF631	10 060 9875
COF067	-	HF167	10 060 9475	COF552	-	HF652	10 060 9595
COF068	-	HF168	10 060 9905	COF555	-	HF655	10 060 9605
COF069	-	HF169	10 060 9915	COF581	-	HF681	10 060 9955
COF070B	-	-	10 060 9965				

10 060 8005

PIAGGIO 1200: Porter Diesel 95-00
1400: Porter Diesel 95-00 • Porter Pick/Van Diesel 98-05
 (Riferimento
 Champion: COF100118S)
 R.O. 493063

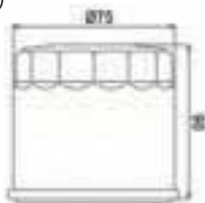
10 060 9025

APRILIA 125: Leonardo 96-05 • Scarabeo Rotax 99-05
 150: Leonardo 96-05 • Scarabeo 99-03
 200: Scarabeo Rotax
BMW: C1 125-200
PEUGEOT: Eliseo Elistar 125-150 • Satelis 125
 (Riferimento
 Champion: COF085)

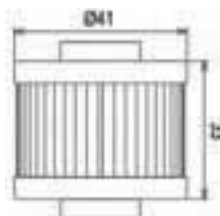

10 060 9035

APRILIA 125: Habana • Mojito
PIAGGIO 125: Liberty 97-00 • Hexagon 98-99 • Sfera 95-97 • Vespa Et4 96-99
 (Riferimento
 Champion: COF081)

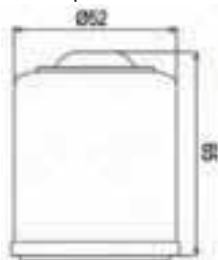

10 060 9045

APRILIA 125-150-200-250-300: Sport City
Scarabeo (Mot. Piaggio)
PIAGGIO 125-150-200-250-300: Liberty • Vespa
• Carnaby • Beverly • Mp3
(Riferimento Champion: COF083)



10 060 9055

SUZUKI 250: Burgman 99-07
400: Burgman 99-06
YAMAHA 400: Majesty 04-11
(Riferimento Champion: COF032)

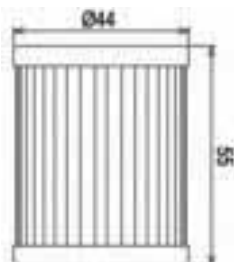

10 060 9065

SUZUKI 125: Epicuro 99-03 • Burgman 02-10 •
Sixteen 08-10 - **150:** Sixteen 08-10
200: Burgman 07-10 - **400:** Burgman 09-13
(Riferimento Champion: COF031)



10 060 9075

APRILIA 400: Scarabeo 06-09 • Atlantic 06-09
500: Scarabeo 02-11 • Atlantic 02-09
PEUGEOT 400-500: Motori Piaggio
PIAGGIO 400: Beverly 06-09 • Mp3 08-10 • X Evo
07-09 • X8 06-08
500: Beverly 03-10 • X9 02-03 • X9 Evolution 03-10
(Riferimento Champion: COF084)

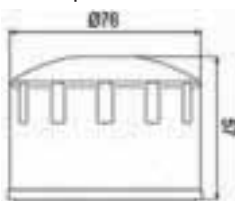

10 060 9085

KYMCO
YAMAHA
(Riferimento Champion: COF047)

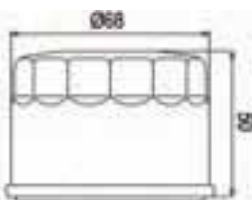

10 060 9105

DUCATI: Tutti i modelli - *All models*
(Riferimento Champion: COF053)

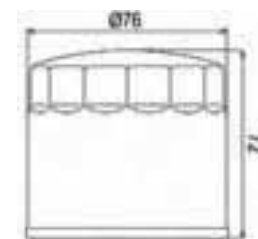

10 060 9125

MOTO GUZZI 850: Le Mans 1,2,3-California-T4 • T5
1000: California 82-93 • Daytona 92-93 • Le Mans
4,5 84-92 • S • Sp • Sp2 • Sp3
(Riferimento Champion: COF452)

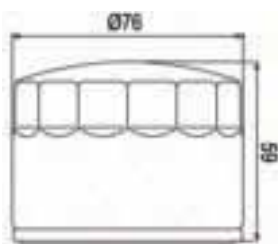

10 060 9135

BMW 750: K75 - **850:** R 850 C - Gs - R - Rt
1000: K100 • K1
1100: K1100 Lt • R 1100 Gs • R • Rs • Rt • S
1150: R1 150 Gs • R • Rs • Rt
1200: K1200 • R1200 C
(Riferimento Champion: COF063)

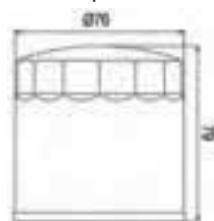

10 060 9155

MOTO GUZZI 850:
Tutti i modelli - *All Models* >06
1000: Daytona 94-01 • V10 97-01
1100: California • V11
1200: Griso • Norge • Sport • Stelvio
(Riferimento Champion: COF451)



10 060 9175

BMW: R45 • R65 • R80 Gs • R • Rt • St • R90 • R100
(Riferimento Champion: COF061)



10 060 9195

HONDA 125-200-250-350-600: XL • Xr
650: Xr • Dominator
KAWASAKI 125-250-300-450: Klx
(Riferimento Champion: COF013)

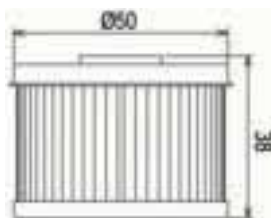

10 060 9205

BMW: F 650
KTM 400-600: Motori Rotax
(Riferimento Champion: COF051)



10 060 9215

KTM-HUSABERG:
(Riferimento Champion: COF055)

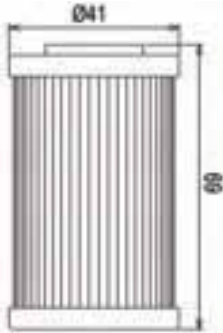

10 060 9225

HUSQVARNA 410-510-610: Te • Tc
(Riferimento Champion: COF054)

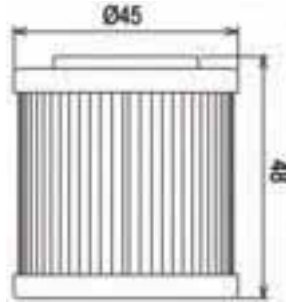

10 060 9245

HONDA 400-500-750-1000: Vf
(Riferimento Champion: COF102)

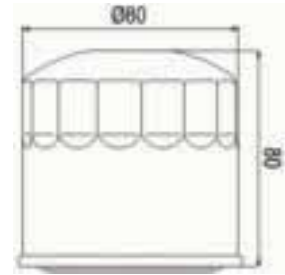

10 060 9275

SUZUKI 250-400-550-750: Gsx
250-450-550-650-750-1100: Gs
(Riferimento Champion: COF033)



10 060 9295

YAMAHA 250: Fzr • Sr • Tt • Xt - **400:** Sr • Srx • Xt
500: Sr • Tt • Xt - **600:** Srx • Tt • Xt
660: Mt 03 • Xtr • Xtx • Xtz - **850:** Tdm - **900:** Tdm
(Riferimento Champion: COF045)

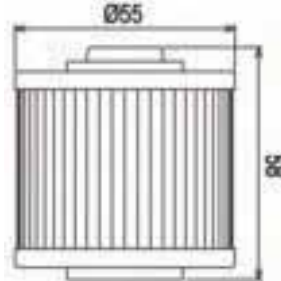

10 060 9325

HONDA 400-500-550-650: Cb • Cbx
(Riferimento Champion: COF011)

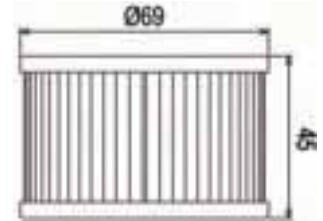

10 060 9355

HONDA-KAWASAKI-MV AGUSTA
TRIUMPH-YAMAHA
(Riferimento Champion: COF104)

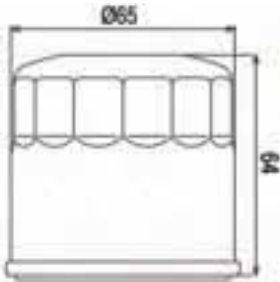

10 060 9375

KYMCO 125: Dink 06-10 • Grand Dink 01-09
150: Grand Dink 01-05
200: Dink 06-10 • Yager Gt 10-13
(Riferimento Champion: COF462)



10 060 9385

YAMAHA 125: X City 07-11 • X Max 06-13
(Riferimento Champion: COF041)



10 060 9415

KAWASAKI 250-300-600-650: KL
(Riferimento Champion: COF023)



10 060 9435

PIAGGIO: Beverly 350 Sport Touring 4T 4V ie 11 >
(Riferimento Champion: COF082)
R.O. 880887



10 060 9455

SUZUKI 250-350-400: Dr
(Riferimento Champion: COF036)

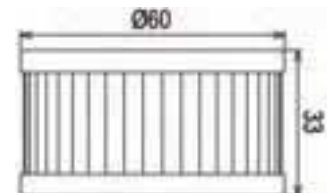

10 060 9475

LML 125-150: Star
(Riferimento Champion: COF067)



10 060 9485

KYMCO 125: Downtown 09-10 • Super Dink 09-13
150: People Gt le 10-11 • **200:** Downtown le 10-11
300: Downtown 09-13 • People Gt
(Riferimento Champion: COF466)



10 060 9495

APRILIA 125-200: Scarabeo Light
(Riferimento Champion: COF086)



10 060 9505

HONDA-KAWASAKI-YAMAHA
(Riferimento Champion: COF203)

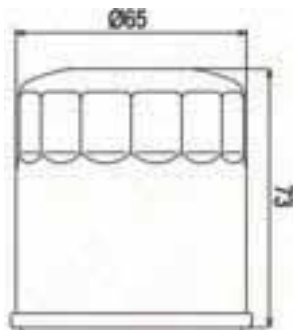

10 060 9515

APRILIA 1000: Rs V4
CAGIVA 650: Raptor • V Raptor
1000: Raptor • V Raptor
SUZUKI
(Riferimento Champion: COF038)



10 060 9525

HUSQVARNA 250: Te 10-12
HONDA 150-250-450: Crf
(Riferimento Champion: COF016)



10 060 9535

HONDA-KAWASAKI-TRIUMPH-YAMAHA
(Riferimento Champion: COF301)

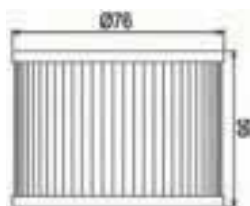

10 060 9545

KTM 250-400-450-520-525-660-690
(Riferimento Champion: COF057)



10 060 9555

BMW: F800 • K1200 Gt • Lt • R • S • Rs
• R1200 Gs 04>
K1600
(Riferimento Champion: COF064)

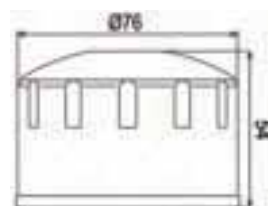

10 060 9565

BUELL 1200
HARLEY DAVIDSON 1340-1450
(Riferimento Champion: COF071C)

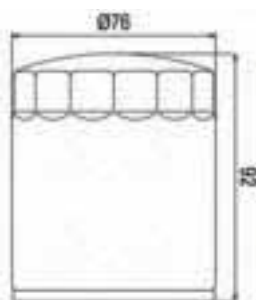

10 060 9575

BETA 250-300: Tutti i modelli - *All models*
SUZUKI 250-450: Rmz
KAWASAKI 250: Kx
(Riferimento Champion: COF107)



10 060 9585

APRILIA 1000: Etv • Rsv
(Riferimento Champion: COF052)



10 060 9595

KTM: Xc • Exc 08>
(Riferimento Champion: COF552)



10 060 9605

HUSABERG 450 - KTM 250: 07>
Tutti i modelli - *All models*
(Riferimento Champion: COF555)

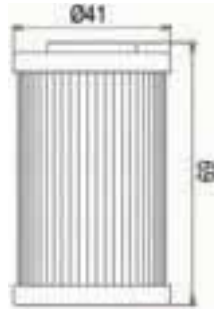

10 060 9615

YAMAHA 250-400-426: Yz • Wr 01-02
(Riferimento Champion: COF042)



10 060 9625

KAWASAKI 450: KLX
SUZUKI 400: Drz
(Riferimento Champion: COF039)

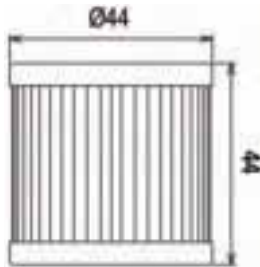

10 060 9635

MBK 125: Xc • YAMAHA 125-250-350: Xt
(Riferimento Champion: COF043)



10 060 9645

YAMAHA: Xj
(Riferimento Champion: COF044)

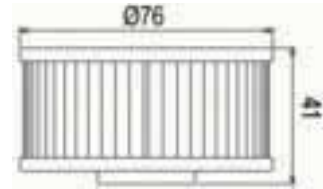

10 060 9655

SUZUKI 500-600-650-800: Dr
(Riferimento Champion: COF037)

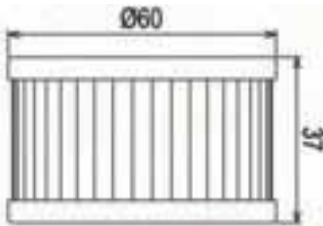

10 060 9665

KTM 620-625-640: Tutti i modelli - All models
(Riferimento Champion: COF056)



10 060 9675

KTM 950-1190: Tutti i modelli - All models
(Riferimento Champion: COF058)



10 060 9685

YAMAHA 1300: Fjr
(Riferimento Champion: COF048)

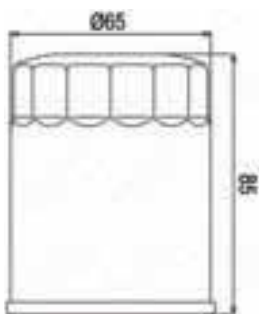

10 060 9695

BMW: S1000 RR • K 1300
(Riferimento Champion: COF060)

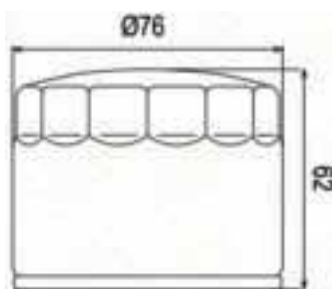

10 060 9705

BMW: F 800 S • St
(Riferimento Champion: COF065)

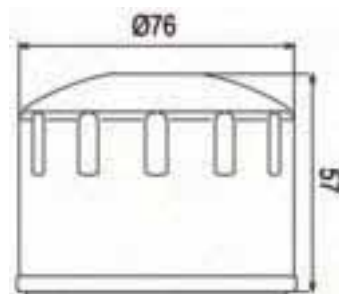

10 060 9715

HARLEY DAVIDSON
(Riferimento Champion: COF070C)

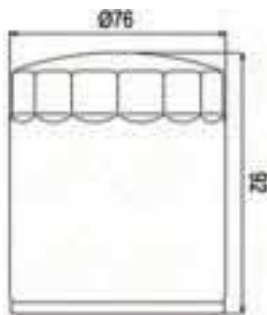

10 060 9725

HARLEY DAVIDSON
(Riferimento Champion: COF072C)



10 060 9735

HARLEY DAVIDSON: V Rod
(Riferimento Champion: COF074C)

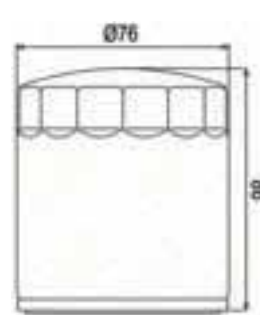

10 060 9745

BUELL 900-1200
(Riferimento Champion: COF077)

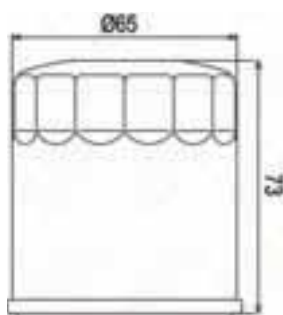

10 060 9755

TRIUMPH 600-509-595-800-955: <03
(Riferimento Champion: COF091)

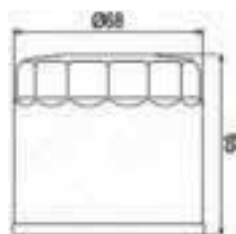

10 060 9765

BENELLI 900: Tornado • 1130: Tnt
(Riferimento Champion: COF453)

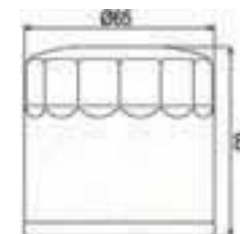

10 060 9775

**APRILIA 750: SL • Smv • 850: Mana
1200: Dorso duro • GILERA 800: Gp**
(Riferimento Champion: COF465)

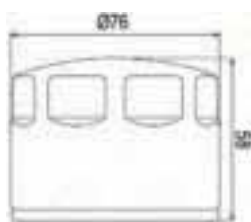

10 060 9785

BMW: G 450 X • HUSQVARNA 449-511
(Riferimento Champion: COF511)



10 060 9795

MV AGUSTA 750-1000: F4
(Riferimento Champion: COF454)

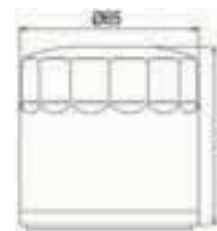

10 060 9805

**APRILIA: Rxv 450-550
HUSQVARNA 250-450-510-530-630: 08>**
(Riferimento Champion: COF463)



10 060 9815

YAMAHA: Xs-Xvz 1200 • Xvz 1300 • Vmx 1200
(Riferimento Champion: COF046)

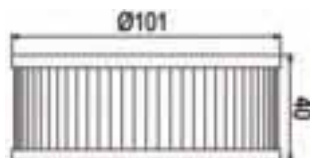

10 060 9875

BETA 350-400-450-498-520: Rr Enduro 10-12
(Riferimento Champion: COF531)

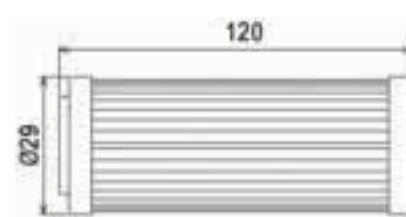

10 060 9885

KYMCO: Xciting 400 12
(Riferimento Champion COF468)



10 060 9895

YAMAHA: Wr 250 • Yz 450
(Riferimento Champion COF040)

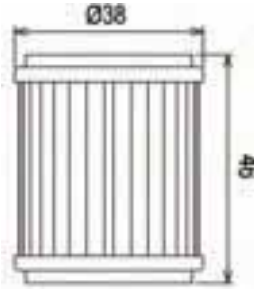

10 060 9905

DAELIM 125: S1 Otello 07> • S2 Freewing 07Z • Ns 07> • SL B Bone 07> • SL History 01>
(Riferimento Champion: COF068)



10 060 9915

DAELIM 125: Vj Roadwin 01> • VL Daystar 01> • Vs Evolution 06>
(Riferimento Champion: COF069)

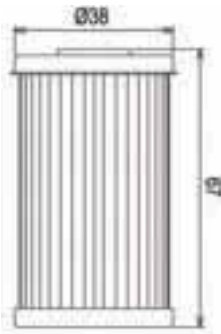

10 060 9925

BOMBARDIER ATV 500: Quest 03-04 • Traxter Auto Cvt 05> • **650:** Quest 02-04 • Quest Max 04> • Quest Xt 02-03 • Traxter Auto Cvt 05> • Traxter Max Auto Cvt 05> • Trail Buck 05> • Trail Buck Ex - Ext 05>
(Riferimento Champion: COF456)

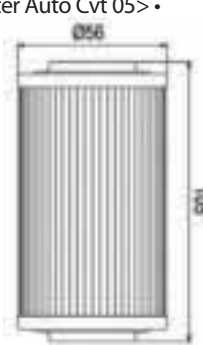

10 060 9935

KYMCO 250: Venox 02-11
(Riferimento Champion: COF461)

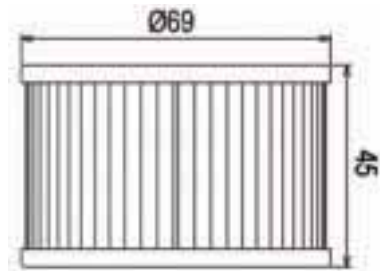

10 060 9945

KAWASAKI 750: Z B1-B4, Y1, Y2, LTD (2 Cylinders) 78-82 • Z D1 (2 Cylinders) 78> • **900:** Z Z1, Z1A, Z1B 73-75 • **1000:** Kz A1, A2, A3, A4 77-81 • Kz B1, B2, B3, B4, Ltd 77-81 • Kz C1, C2, C3, C4, C4A 78-81 • Kz D1, D2, D3 78-80 • Kz E1, E2, G1 78-80 • Z A1, A2, A3, A4 77-81 • Z D1 (Z1R) 78> • Z E1, E2, St 79-80 • Z H1, H2 74-75 • **1300:** Kz A1, A2, A3, A4, A5 79-83 • Kz B2 80> • Zn A1, A6 Voyager 83-88
(Riferimento Champion: COF026)



10 060 9955

HYOSUNG 650: Gt Comet 05-08 • Gt Comet Efi 09-11 • Gt Naked 04-06 • Gt Naked Se I 07-08 • Gt R Comet Efi 09-11 • Gt R Sport Fi 07-08 • Gt R Sporttouring 05-08 • Gt S Comet Efi 10-11 • Gt S Sport 05-08 • Gv Aquila 05-08 • Gv Aquila Efi 09-11 • Gv Avitar Efi 11> • Gv Se Efi 11> • St7 10-11 • **700:** Gv C Efi 10-11
(Riferimento Champion: COF581)



10 060 9965

HARLEY DAVIDSON
(Riferimento Champion: COF070B)

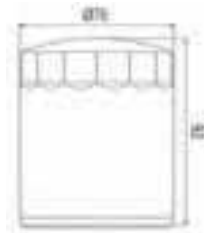

10 060 9975

BUELL 1200
HARLEY DAVIDSON 1340-1450
(Riferimento Champion: COF071B)

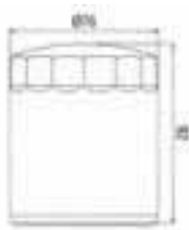

10 060 9985

PIAGGIO 1000-1300: Porter 16V
(Riferimento Champion: COF100180S)



10 060 9995

PIAGGIO 500: AL Diesel 04-07
Ligier 162 Ambra 98-00
Ligier Nova 00 • M - Pk 03-10 • Quargo 05-12
750: Quargo Diesel 04-06
(Riferimento Champion: COF100136S)
R.O. 850284





10 075 1000 

PIAGGIO 50: Vespa V5B1/2/3
Resistente fino a 500° verniciata trasparente
500° heat resistance transparent painting
(R.O.137655)



10 075 1010 

PIAGGIO 125: Vespa Primavera VMA2
Resistente fino a 500° verniciata trasparente
500° heat resistance transparent painting
(R.O.120218)



10 075 1020 

PIAGGIO 150: Vespa Sprint-GL-Sprint Veloce
VLB-VLB1T-VLA
Resistente fino a 500° verniciata trasparente
500° heat resistance transparent painting
(R.O.124046)



10 075 1030 

PIAGGIO 200: Vespa Pe-Px VSX-VSX2
Resistente fino a 500° verniciata nera
500° heat resistance black painting
(R.O.417809)



10 075 1040 

PIAGGIO 125-150: Vespa Px
VNX-VLX-VNX2-VLX2
(R.O.417806)



10 075 1090 

PIAGGIO 50: Ape 1° Serie
Resistente fino a 500° verniciata nera
500° heat resistance black painting
(R.O. 129246)



10 075 1100 

PIAGGIO 50: Vespa Pk-Pk-XL - V5N1T-VBN2T
Resistente fino a 500 gradi verniciata nera
500° heat resistance black painting
(R.O. 2431304)



10 075 1110 

PIAGGIO 50: Ciao - Px
(R.O. 2472605)

10 075 1120 

Si - Si FL2
(R.O. 2144034)



10 075 1140  

PIAGGIO 50: Ape Europa
Resistente fino a 500° verniciata nera
500° heat resistance black painting
(R.O. 830452)



10 075 1150  

PIAGGIO 125-150: Vespa Px
Modello Touring - Touring model



10 075 1160  

PIAGGIO 200: Vespa P E
Modello Touring - Touring model



10 075 1170  

PIAGGIO 125-150: Vespa Super
(R.O. 131869)



Marmitte non omologate. Vietato l'uso su strade pubbliche
Only for race and show. For road legal use in your country, contact local traffic authorities



MARMITTE PIAGGIO VESPA - APE
PIAGGIO VESPA - APE SILENCERS

14 280 0040



TERMINALE MARMITTA-EXHAUST TERMINAL

Vari modelli Vespa - *Various Vespa models*
 (R.O. 610157M)



14 280 0060



TUBETTO MARMITTA - EXHAUST TUBE

Vari modelli Vespa - *Various Vespa models*



LANA DI ROCCIA - ROCK WOOL

10 072 0010



CARTUCCIA LANA DI ROCCIA Ø 60 x 170

Silenziatore cross
Rock wool cartridge for cross silencers



10 072 0020



CARTUCCIA LANA DI ROCCIA Ø 80 x 300

Silenziatore cross
Rock wool cartridge for cross silencers



10 072 0030



FOGLIO LANA DI ROCCIA 600 x 320 x 30

Per marmitta scooter
Rock wool sheet for scooter muffler



▶ CINGHIE TRASMISSIONE

TRANSMISSION BELTS





CINGHIE TRASMISSIONE DENTATE SCOOTER

COGGED TRANSMISSION BELTS FOR SCOOTER

CC	MODELLO - MODEL	ANNO YEAR					RIFERIMENTO ORIGINALE OEM NUMBER
			CODICE ORIGINALE ORIGINAL CODE	CONFEZ. INDUSTR. INDUSTRIAL PACKING	RACING POWER PLUS KEVLAR	CODICE ORIGINALE ORIGINAL CODE	
			16 375 (_ _ _ _)				
APRILIA							
50	Amico	94	0080	0089	0082	0081	AP8206109
50	Amico	96-98	0080	0089	0082	0081	AP8206109
50	Amico GL-GLE	93-95	0080	0089	0082	0081	AP8206109
50	Amico Lx- Sport-Cat	92-93	0080	0089	0082	0081	AP8206109
50	Area 51	98-00	0080	0089	0082	0081	AP8206109
50	Gulliver	95-98	0080	0089	0082	0081	AP8206109
50	Gulliver Lc	96-98	0080	0089	0082	0081	AP8206109
50	Mojito	04-08	0250	0259	0252	0251	436864
50	Mojito Custom	99-03	0320			0321	2MCA000014
50	Mojito Retro	99-03	0320			0321	2MCA000014
50	Rally	95-03	0080	0089	0082	0081	AP8206109
50	Rally Lc	96-99	0080	0089	0082	0081	AP8206109
50	Scarabeo	93-97	0080	0089	0082	0081	AP8206109
50	Scarabeo	98-05	0080	0089	0082	0081	AP8206109
50	Scarabeo 2T	10	0060	0069			AP8570076
50	Scarabeo 2T Net	10	0060	0069			AP8570076
50	Scarabeo 4T	02-06	0060	0069			AP8570076
50	Scarabeo 4T 4V	10	0060	0069			AP8570076
50	Scarabeo 4T Net	10	0060	0069			AP8570076
50	Scarabeo 4T Rst Eu3	06-09	0060	0069			AP8570076
50	Scarabeo Ditech	01-04	0320			0321	2MCA000014
50	Scarabeo Quattro	09	0060	0069			AP8570076
50	Scarabeo Street 2T Rst	06-09	0060	0069			AP8570076
50	Sonic	98-07	0670				AP8206818
50	Sonic Gp	98-08	0670				AP8206818
50	Sport City One 2T	08-09	0060	0069			AP8570076
50	Sport City One 4T	08	0060	0069			AP8570076
50	Sr	93-96	0080	0089	0082	0081	AP8206109
50	Sr Ditech Eu2	02-03	0320			0321	2MCA000014
50	Sr H2O Ditech E Carburatore	00-03	0320			0321	2MCA000014
50	Sr Liquid Cooled	94-96	0080	0089	0082	0081	AP8206109
50	Sr R Factory Ie E Carburatore	10	0250	0259	0252	0251	436864
50	Sr R Factory Mot Aprilia	05	0320			0321	2MCA000014
50	Sr R R Factory	04-09	0250	0259	0252	0251	436864
50	Sr Stealth, Racing	97-99	0080	0089	0082	0081	AP8206109
50	Sr Street	03-08	0250	0259	0252	0251	436864
50	Sr Www	97-01	0080	0089	0082	0081	AP8206109
100	Scarabeo 4T	01-04			0630		AP8551053
100	Scarabeo 4T	10			0630		AP8551053
100	Scarabeo 4T Net	10			0630		AP8551053
100	Scarabeo 4T Rst	06-09			0630		AP8551053
100	Scarabeo Mot Minarelli	00	0620				AP8510604.
100	Scarabeo Mot Yamaha	00	0620				AP8510604.
125	Atlantic	03-05		0669	0660		AP8580246
125	Atlantic	03-05			0810		AP8580261
125	Atlantic Eu3	06-08		0389	0380		841213

CINGHIE TRASMISSIONE DENTATE SCOOTER
COGGED TRANSMISSION BELTS FOR SCOOTER



CC	MODELLO - MODEL	ANNO YEAR	DAYCO			RMS YOUR BEST PARTNER	RIFERIMENTO ORIGINALE OEM NUMBER
			CODICE ORIGINALE ORIGINAL CODE	CONFEZ. INDUSTR. INDUSTRIAL PACKING	RACING POWER PLUS KEVLAR	CODICE ORIGINALE ORIGINAL CODE	
			16 375 (_ _ _ _)				
125	Leonardo	96-01			0580		AP0280102
125	Leonardo St	03-04			0580		AP0280102
125	Mojito	03-08		0389	0380		841213
125	Mojito Retro' - Custom	99-01	0260				AP8550363
125	Scarabeo	04-06			0790		841851
125	Scarabeo Eu3	06-07			0690		AP8575041
125	Scarabeo Mot Rotax	99-03			0580		AP0280102
125	Sport City	04-06			0690		AP8575041
125	Sport City Cube	08			0690		AP8575041
125	Sport City Eu3	06-08			0690		AP8575041
125	Sport City Eu3	06-08			0790		841851
125	Sport City One T4 Eu3	08-10		0389	0380		841213
150	Leonardo Mot.Rotax	96-03			0580		
150	Mojito	03-05			0380		
150	Scarabeo -Gt Mot.Rotax	99-03			0580		
150	Scarabeo -Gt Mot.Piaggio	03->			0600		
150	Sport City	04->			0600		
150	Sr	99->			0300		8550130/434812
200	Atlantic	02-05		0669	0660		
200	Scarabeo-GT Mot.Piaggio	03->			0690		
200	Scarabeo -Gt Mot.Rotax	99-03			0580		
200	Sport City	04->			0690		
250	Scarabeo Light	06-08			0790		841851
250	Sport City Cube	08			0790		841851
300	Scarabeo Light	09			0790		841851
400	Atlantic Sprint	05-08			0680		AP8560188
400	Scarabeo Light	06-08			0680		AP8560188
500	Atlantic	01-04			0680		AP8560188
500	Scarabeo	03-06			0680		AP8560188
ATALA							
50	Hacker		0120				
BAOTIAN							
50	Baotian Scooter Bt 49Q 7-9-11					1211	
50	Gyg Motori 4T		1000				
BSV							
50	Ax Gz		0110				
50	Sp Dio		0130				
50	Gp Dio Zx		0210				
BENELLI							
50	Naked Mot.Minarelli	02	0080	0089	0082	0081	R16140011AO
50	491 Gt-Rr-St-Sp-Mot.Minarelli	97-02	0080	0089	0082	0081	R16140011AO
50	491 Sport-Racing-Mot.Minarelli	98-02	0080	0089	0082	0081	R16140011AO
50	K2 Air-Lc-Namur mot.Minarelli	98->	0080	0089	0082	0081	R16140011AO
50	Pepe-LX Mot.Minarelli	98->	0080	0089	0082	0081	R16140011AO
125-150	Adiva	01->		0389	0380		R13440941AO
125-150	Velvet-Touring	99->			0300		R16140631AO
250	Velvet-Touring	98->		0659	0650		R16040171AO



CINGHIE TRASMISSIONE DENTATE SCOOTER

COGGED TRANSMISSION BELTS FOR SCOOTER

CC	MODELLO - MODEL	ANNO YEAR	DAYCO			RMS <small>YOUR BEST PARTNER</small>	RIFERIMENTO ORIGINALE OEM NUMBER
			CODICE ORIGINALE ORIGINAL CODE	CONFEZ. INDUSTR. INDUSTRIAL PACKING	RACING POWER PLUS KEVLAR	CODICE ORIGINALE ORIGINAL CODE	
			16 375 (----)				
BETAMOTOR							
50	Tempo 13"	94-95	0080	0089	0082	0081	33-01290
50	Tempo 16" -Quadra-Chrono 502	96->	0080	0089	0082	0081	33-01290
50	Ark-Ark Lc-K	96->	0080	0089	0082	0081	33-01290
50	Eikon	99->	0080	0089	0082	0081	33-01290
125-150	Eikon	99->			0580		36-10750
BMW							
125-200	C1	00->			0580		
CPI							
50	Oliver - Popcorn - Aragon GP 03		1150				
DERBI							
50	Atlantis	99-01	0360				00G02605371
50	Atlantis 02	02	0250	0259	0252	0251	436864
50	Atlantis 02 Bullet	03-05	0250	0259	0252	0251	436864
50	Atlantis 02 City	03-06	0250	0259	0252	0251	436864
50	Atlantis 02 Red Bullet	03	0250	0259	0252	0251	436864
50	Atlantis 02 Two Chic	05	0250	0259	0252	0251	436864
50	Atlantis 2T Eu2	07-09	0250	0259	0252	0251	436864
50	Atlantis 4T Eu2	07	0840				842907
50	Atlantis 50-100 4T	04-06	0840				842907
50	Atlantis Lc	99-01	0360				00G02605371
50	Boulevard 2T	09	0060	0069			AP8570076
50	Boulevard 4T Eu2 25 Km/H	09	0840				842907
50	Gp1	01-03	0250	0259	0252	0251	436864
50	Gp1 Eu2	05	0250	0259	0252	0251	436864
50	Gp1 Open Eu2	06-09	0250	0259	0252	0251	436864
50	Gp1 Race Eu2	05-07	0250	0259	0252	0251	436864
50	Hunter	96-97	0520				00G02602371
50	Hunter	>99	0180				00G02605371
50	Predator Lc	98-01	0360				00G02605371
50	Predator O2	98-01	0360				00G02605371
50	Vamos		0170				337127204
125	Boulevard Eu3	04-07		0389	0380		841213
125	Boulevard 4T Eu3	08-09		0389	0380		841213
125	Gp1 Eu2	06		0389	0380		841213
125	Gp1 Low Seat 125 Eu3	07-08		0389	0380		841213
125	Rambla	08			0600		842009
200	Boulevard	05		0669	0660		840908
250	Gp1	06-07			0810		843963
250	Gp1 Low Seat 250 Eu3	07-08			0810		843963
250	Rambla	08			0790		841851
300	Rambla	10			0790		841851
GARELLI							
50	Pony		0090				
50	Big Well - Racing Sr		0110				
50	Ciclone	06-08				1211	
50	Capri - Capri Lx	06-08				1211	

CINGHIE TRASMISSIONE DENTATE SCOOTER
COGGED TRANSMISSION BELTS FOR SCOOTER



CC	MODELLO - MODEL	ANNO YEAR	DAYCO			RMS YOUR BEST PARTNER	RIFERIMENTO ORIGINALE OEM NUMBER
			CODICE ORIGINALE ORIGINAL CODE	CONFEZ. INDUSTR. INDUSTRIAL PACKING	RACING POWER PLUS KEVLAR	CODICE ORIGINALE ORIGINAL CODE	
			16 375 (----)				
GILERA							
50	Dna-Gp-Experience	00-06	0060	0069		0061	82712R
50	Ice	01-05	0250	0259	0252		436864
50	Runner	97-00	0250	0259	0252		436864
50	Runner Poggiali	02	0250	0259	0252		436864
50	Runner Purejet	02-04	0250	0259	0252		436864
50	Runner Sp	02-07	0250	0259	0252		436864
50	Runner Sp	10	0250	0259	0252		436864
50	Runner Sp Spec Edit	07	0250	0259	0252		436864
50	Runner Sp St & Simoncelli	08-09	0250	0259	0252		436864
50	Stalker	97-09	0250	0259	0252		436864
50	Stalker Naked	08	0250	0259	0252		436864
50	Stalker Spec Edit	07-08	0250	0259	0252		436864
50	Storm	94-95	0010	0019	0012		430728
50	Storm Eu2	07	0250	0259	0252		436864
50	Typhoon	94-97	0010	0019	0012		430728
50	Typhoon X	98-99	0010	0019	0012		430728
50	Typhoon Xr	00	0250	0259	0252		436864
125	Dna	01		0389	0380		841213
125	Nexus Eu3	07-08		0389	0380		841213
125	Nexus Eu3 le	08-09		0389	0380		841213
125	Runner Fx-Fxr	97-02	0190				434812
125	Runner Vx	05-06		0389	0380		841213
125	Runner Vx 4T Eu3	07		0389	0380		841213
125	Runner Vx 4T St Eu3	08-09		0389	0380		841213
125	Runner Vx Race	06		0389	0380		841213
125	Runner Vx Sc	06-07		0389	0380		841213
125	Runner Vx-Vxr	02-04		0389	0380		841213
125	Runner Vx-Vxr	02-04		0669	0660		840908
125	Typhoon	95-98	0190				434812
125	Typhoon X-Xr	99-00	0190				434812
180	Dna	01		0669	0660		840908
180	Runner Vxr	00-01		0669	0660		840908
180	Runner Fxr	97-00			0200		484497
200	Runner Vxr	05-06		0669	0660		840908
200	Runner Vxr 4T St Eu3	08		0669	0660		840908
200	Runner Vxr Eu3	07		0669	0660		840908
200	Runner Vxr Race	06		0669	0660		840908
500	Nexus	03-05			0680		832738
500	Nexus Eu3	09			0680		832738
500	Nexus Sp Eu3	06-07			0680		832738
HSC							
50	Sc	01	0130				
50	Sc - L - Zx	01	0210				



CINGHIE TRASMISSIONE DENTATE SCOOTER

COGGED TRANSMISSION BELTS FOR SCOOTER

CC	MODELLO - MODEL	ANNO YEAR	DAYCO			RMS <small>YOUR BEST PARTNER</small>	RIFERIMENTO ORIGINALE OEM NUMBER
			CODICE ORIGINALE ORIGINAL CODE	CONFEZ. INDUSTR. INDUSTRIAL PACKING	RACING POWER PLUS KEVLAR	CODICE ORIGINALE ORIGINAL CODE	
16 375 (_ _ _ _)							
HONDA							
50	Gp Dio	91	0130				723590
50	Lead	87-95	0140			0141	706618
50	Sfx V	95	0150				723590
50	Sh	96	0230				23100GBY901
50	Sh	96				0431	
50	Shadow		0150				723590
50	Sj Bali	93	0150				723590
50	Sky	97				0431	
50	Sv	95	0150				723590
50	Sxr	95	0150				723590
50	Vision Prima Serie	85-87	0130				723590
125	Chiocciola	00-06	0470	0479			23100KGF9010
125	Dylan	01-06	0470	0479			23100KGF9010
125	Pantheon 2T	98-02			0310		23100KFF900
125	Pantheon 4T	05-06	0470	0479			23100KGF9010
125	Pcx	10-12			1302		23100KWN901
125	Sh 125	01-08	0470	0479			23100KGF9010
125	Sh 125I	01-08	0470	0479			23100KGF9010
150	Chiocciola	00-06	0730	0739			23100KGG911
150	Dylan	01-06	0730	0739			23100KGG911
150	Pantheon 2T	98-02			0310		23100KFF900
150	Pantheon 4T	03-06	0730	0739			23100KGG911
150	Sh - @ - Pantheon - Dylan	01-08	0730	0739			23100KGG911
250	Cn 4T		0280	0289			H.23100KM1671
250	Foresight	98			0780		23100KFG641
250	Jazz	00-04			0780		23100KFG641
300	Sh	07-08			1020		23100KTW901
300	Sh 300I Abs	07>			1020		23100KTW901
ITALJET							
50	Pista 1-Bazooka 1/2 Reporter		0090			0091	9511190
50	Pista 2 Scoop 2/3 Yankee	92-93	0080	0089	0082	0081	3351015
50	Jet Set	02->	0250	0259	0252		210436864
50	Torpedo 2T - (Mot.Morini)	97-00	0120				338127227
50	Torpedo 2T (Mot.Piaggio)	01-03	0050		0052		210480852
50	Torpedo 4T	02->	0050		0052		210480852
50	Formula Air-Lc	94->	0120				338127227
50	Velocifero	93->	0170				337127204
125	Dragster	99->	0190				210434812
125	Torpedo	99-00	0260				210825059
125-150	Millenium	00->			0300		4871702090
125-150	Jet Set	01->		0389	0380		210487170
125-150	Jupiter	02->			0300		4871702090
125-150	Torpedo Mot.Leader	00-01		0389	0380		210487170
180	Dragster	99->			0200		210484497
250	Jupiter	01->		0659	0650		4711702092

CINGHIE TRASMISSIONE DENTATE SCOOTER
COGGED TRANSMISSION BELTS FOR SCOOTER



CC	MODELLO - MODEL	ANNO YEAR	DAYCO			RMS YOUR BEST PARTNER	RIFERIMENTO ORIGINALE OEM NUMBER
			CODICE ORIGINALE ORIGINAL CODE	CONFEZ. INDUSTR. INDUSTRIAL PACKING	RACING POWER PLUS KEVLAR	CODICE ORIGINALE ORIGINAL CODE	
			16 375 (----)				
KEEWAY F-ACT							
50	Hurricane Eu2 - Matrix		1150				
KYMCO							
50	Agility 2T R16	10	0330		0332	00107541	
50	Agility 4T R12	07-08	0330		0332	00107541	
50	Agility 4T R16	08-09	0330		0332	00107541	
50	Agility R12	05	0330		0332	00107541	
50	Agility Rs	09	0330		0332	00107541	
50	Agility Rs Naked 2T	10	0330		0332	00107541	
50	B&W	02	0330		0332	00107541	
50	B&W Eu2	03	0330		0332	00107541	
50	Cx	93	0210			00107006	
50	Cx Super	94-97	0210			00107006	
50	Dink 50 4T	07	0330		0332	00107541	
50	Dink Classic Eu2	03	0330		0332	00107541	
50	Dink Lc	98-02	0330		0332	00107541	
50	Dj W	94-00	0210			00107006	
50	Dj X	91-92	0210			00107006	
50	Djy	93	0210			00107006	
50	Like 2T	09	0330		0332	00107541	
50	Like 4T	09	0330		0332	00107541	
50	People	04	0330		0332	00107541	
50	People	99-00	0330		0332	00107541	
50	People Eu2	03	0330		0332	00107541	
50	People Eu2	08	0330		0332	00107541	
50	People S	05-08	0330		0332	00107541	
50	People S 4T	06-08	0330		0332	00107541	
50	Super 8	07	0330		0332	00107541	
50	Super 8 2T	09	0330		0332	00107541	
50	Super 8 4T	09	0330		0332	00107541	
50	Super 9	00	0330		0332	00107541	
50	Super 9 Sport Eu2	03-04	0330		0332	00107541	
50	Top Boy	97-00	0330		0332	00107541	
50	Vitality 2T	04	0330		0332	00107541	
50	Vitality 4T	04	0330		0332	00107541	
50	Yup	02	0330		0332	00107541	
50	Yup Eu2	03	0330		0332	00107541	
125	Agility 4T	06			0442	0441	00127541
125	Agility 4T Eu3	06-08			0442	0441	00127541
125	Agility Carry	11			0442		00127541
125	Agility R16	08-12			0442	0441	00127541
125	Agility Rs	09			0442	0441	00127541
125	B&W	00			0580		00127985
125	B&W Eu2	03-04			0580		00127985
125	Dink	97-98			0580		00127985
125	Dink Classic	02			0580		00127985
125	Dink Classic Eu2	03			0580		00127985



CINGHIE TRASMISSIONE DENTATE SCOOTER

COGGED TRANSMISSION BELTS FOR SCOOTER

CC	MODELLO - MODEL	ANNO YEAR	DAYCO			RMS <small>YOUR BEST PARTNER</small>	RIFERIMENTO ORIGINALE OEM NUMBER
			CODICE ORIGINALE ORIGINAL CODE	CONFEZ. INDUSTR. INDUSTRIAL PACKING	RACING POWER PLUS KEVLAR	CODICE ORIGINALE ORIGINAL CODE	
			16 375 (_ _ _ _)				
125	Dink Eu3	06-07			0580		00127985
125	Dink Lx	98-00			0580		00127985
125	Grand Dink	01-02			0580		00127985
125	Grand Dink Eu2	03-04			0580		00127985
125	Like	09			0442	0441	00127541
125	Like Lx	12			0442		00127541
125	Movie	99-00			0490		00127785
125	Movie Eu3	06-07			0442	0441	00127541
125	Movie XL	01			0442	0441	00127541
125	Movie XL Eu2	03-04			0442	0441	00127541
125	People	99-00			0442	0441	00127541
125	People Eu2	03			0442	0441	00127541
125	People Eu3	07-11			0442		00127541
125	People One I	13			0442	0441	00127541
125	People S	05			0442	0441	00127541
125	People S DD Eu3	07-08			0442	0441	00127541
125	Super 8	08-09			0442		00127541
125	Vivio	00			0490		00127785
150	Agility R16	08-09			0442	0441	00127541
150	Heroism	95-97			0490		00127785
150	Movie Eu3	06-07			0442	0441	00127541
200	Dink Classic	04			1130		00127021
200	Dink Eu3I	06-07			1140		00127099
250	B&W	00			0720		00127998
250	B&W Eu2	03			0720		00127998
250	Grand Dink	01-02			0720		00127998
250	Grand Dink Eu2	03-04			0720		00127998
250	Kxr	03-04			0720		00127998
250	Mxu	05			0720		00127998
250	People Lc	03-04			0820		00127543
250	People S	06			0820		00127543
250	People S 250I	07			0820		00127543
250	X Citing	05			0820		00127543
250	Yup	03			0720		00127998
300	K-Xct I	12			1402		00123375
300	K-Xct I Abs	14			1402		00123375
300	Maxxer	05-06			0720		00127998
300	Mxu	05-06			0720		00127998
300	Mxu R	10			0720		00127998
300	People Gti Abs	12			1402		00123375
300	People S 300I	08			0820		00127543
500	X Citing	05			0880		00127038
500	X Citing 500 R	09			0880		00127038
500	X Citing 500I	06-08			0880		00127038
500	X Citing 500I R	07-08			0880		00127038

CINGHIE TRASMISSIONE DENTATE SCOOTER

COGGED TRANSMISSION BELTS FOR SCOOTER



CC	MODELLO - MODEL	ANNO YEAR	DAYCO			RMS YOUR BEST PARTNER	RIFERIMENTO ORIGINALE OEM NUMBER
			CODICE ORIGINALE ORIGINAL CODE	CONFEZ. INDUSTR. INDUSTRIAL PACKING	RACING POWER PLUS KEVLAR	CODICE ORIGINALE ORIGINAL CODE	
			16 375 (----)				
LEM							
50	Flash - ghibli - tornado		0090			0091	
MALAGUTI							
50	Ciak Mono Euro 2-2.2.3.	03	0080	0089	0082	0081	71700500
50	Ciak Master 4T	05-06	0050		0052		41701400
50	Ciak master Euro 2	04-06	0080	0089	0082	0081	71701000
50	Ciak -Ciak Td	99-01	0080	0089	0082	0081	71700500
50	Centro SL	94-98	0080	0089	0082	0081	71700300
50	Centro base	93-94	0080	0089	0082	0081	71700300
50	Centro SL Kat	99-00	0080	0089	0082	0081	71700300
50	Crosser Cr1	95-98	0120				60323800
50	F10 Restyling Euro 2-2.3.	03-04	0110				71700100-600
50	F10 Jet Line	92-98	0110				71700100-600
50	F10 Restyling Euro 1	01-02	0110				71700100-600
50	F10 Kat	99-00	0110				71700100-600
50	F10 Restyling Euro 2	02-06	0110				71701300
50	F12 Phantom Restyling Euro 2-2.3	03-04	0080	0089	0082	0081	71700300
50	F12 Phantom Lc Restyling Euro 2-2.3	03-04	0080	0089	0082	0081	71700300
50	F12 Phantom Restyling Euro 2	02-06	0080	0089	0082	0081	71700300
50	F12 Phantom Lc Restyling	02	0080	0089	0082	0081	71700300
50	F12 Phantom Lc - aria	94-98	0080	0089	0082	0081	71700300
50	F12 Phantom Lc Restyling Euro 1	01-02	0080	0089	0082	0081	71700300
50	F12 Phantom Restyling Euro 1	01-02	0080	0089	0082	0081	71700300
50	F12 Phantom Lc Twin Disks	98	0080	0089	0082	0081	71700300
50	F12 Phantom Euro 1 - Lc aria	99-00	0080	0089	0082	0081	71700300
50	F12 Phantom Lc Restyling Euro 2	06	0080	0089	0082	0081	71701000
50	F12 R Aria	07-08	1150				
50	F15 Lc-Tds Restyling Euro 1	01	0080	0089	0082	0081	71700300
50	F15 Fire Fox Restyling Euro 2-2.3	03-04	0080	0089	0082	0081	71700300
50	F15 Fire Fox Euro 2	02-03	0080	0089	0082	0081	71700300
50	F15 Fire Fox Air Cooled	05-06	0080	0089	0082	0081	71701000
50	F15 Lc Restyling Euro 2	04-05	0080	0089	0082	0081	71701000
50	F15 Fire Fox	94-98	0080	0089	0082	0081	71700300
50	F15 Fire Fox Twin Disk e Special	98-99	0080	0089	0082	0081	71700300
50	F15 Fire Fox Twin Disk Digit Kat	98-00	0080	0089	0082	0081	71700300
50	Grizzly 4 Wheels	04-05	0110				71700100/71700600
50	Yesterday - Yesterday Euro	97-00	0110				71700100-600
100	F12 Phantom - Ciak	99-00			0390		60330200
125	Ciak Restyling Euro 2	03			0550		51700600
125	Ciak Master	04			0550		51700600
125	Ciak Master Euro 3	06			0550		51700600
125	Ciak	00-01			0550		51700600
125	F 18 Warrior	00-02			0580		51700300
125	Phantom Max	03			0300		71700900
125	Madison Restyling Euro 2	03-04			0300		71700700
125	Madison Restyling	02			0300		71700700
125	Madison 3	06		0389	0380		41701500



CINGHIE TRASMISSIONE DENTATE SCOOTER

COGGED TRANSMISSION BELTS FOR SCOOTER

CC	MODELLO - MODEL	ANNO YEAR	DAYCO			RMS <small>YOUR BEST PARTNER</small>	RIFERIMENTO ORIGINALE OEM NUMBER
			CODICE ORIGINALE ORIGINAL CODE	CONFEZ. INDUSTR. INDUSTRIAL PACKING	RACING POWER PLUS KEVLAR	CODICE ORIGINALE ORIGINAL CODE	
			16 375 (_ _ _ _)				
125	Madison	99-01			0300	71700700/900	
125-160	Blog le	09	0730	0739			
125-160	Centro le	08-09	0730	0739			
125-160	Centro SL le	09	0730	0739			
150	Ciak Restyling Euro 2	03			0550	51700600	
150	Ciak Master	04			0550	51700600	
150	Ciak	00-02			0550	51700600	
150	F 18 Warrior	00-02			0580	51700300	
150	Madison T.	99-01			0300	71700700	
180	Madison R.	01-02		0669	0660	41700300/700	
200	Ciak Master Euro 2	06			0550	51700700	
200	Madison S. Restyling	02		0669	0660	41700300/700	
200	Madison S. Restyling Euro 2	03		0669	0660	41700700	
200	Phantom Max	03		0669	0660	41700700	
250	Madison 3	06	0810		0812	41700900	
250	Madison RS Restyling	04	0810		0812	41700900	
250	Madison S.	99-01		0659	0650	91700200	
250	Phantom Max	04	0810		0812	41700900	
250	Password - Password Eu 3	05-07			0560	71701100	
500	Spider Max Gt - Gt Euro 3	04-06			0680	41701100	
MBK							
50	Booster	01-04	0080	0089	0082	0081	5RNE76410000
50	Booster	90-91	0080	0089	0082	0081	5RNE76410000
50	Booster Naked	03	0080	0089	0082	0081	5RNE76410000
50	Booster Ng Eu1	99-00	0080	0089	0082	0081	5RNE76410000
50	Booster Road	94-95	0080	0089	0082	0081	5RNE76410000
50	Booster Rocket	97-98	0080	0089	0082	0081	5RNE76410000
50	Booster Spirit	96-98	0080	0089	0082	0081	5RNE76410000
50	Booster Spirit	99-00	0080	0089	0082	0081	5RNE76410000
50	Booster Spirit Eu2	02	0080	0089	0082	0081	5RNE76410000
50	Booster Spirit Eu2	02-03	0080	0089	0082	0081	5RNE76410000
50	Booster Track	96-98	0080	0089	0082	0081	5RNE76410000
50	Evolis	92-95	0110				3WF176410000
50	Fizz	94-95	0110				3WF176410000
50	Flipper	98-02	0080	0089	0082	0081	5RNE76410000
50	Flipper Eu2	03-04	0080	0089	0082	0081	5RNE76410000
50	Forte	94-96	0110				3WF176410000
50	Mach G Eu1	02-03	0080	0089	0082	0081	5RNE76410000
50	Mach G Eu2	02-04	0080	0089	0082	0081	5RNE76410000
50	New Sorriso	95-96	0410				3GF176410000
50	Nitro	97-04	0080	0089	0082	0081	5RNE76410000
50	Nitro Eu2	03	0080	0089	0082	0081	5RNE76410000
50	Ovetto - Eu1 - Eu2	97-04	0080	0089	0082	0081	5RNE76410000
50	Rs Booster Ng	95-03	0080	0089	0082	0081	5RNE76410000
50	Sorriso	91-95	0090				23Y176410000
50	Stunt	00-02	0080	0089	0082	0081	5RNE76410000
50	Target	91-95	0110				3WF176410000

CINGHIE TRASMISSIONE DENTATE SCOOTER
COGGED TRANSMISSION BELTS FOR SCOOTER



CC	MODELLO - MODEL	ANNO YEAR	DAYCO			RMS YOUR BEST PARTNER	RIFERIMENTO ORIGINALE OEM NUMBER
			CODICE ORIGINALE ORIGINAL CODE	CONFEZ. INDUSTR. INDUSTRIAL PACKING	RACING POWER PLUS KEVLAR	CODICE ORIGINALE ORIGINAL CODE	
			16 375 (----)				
125	Flame	95-99	0530				4CW176410200
125	Flame F	00	0530				4CW176410200
125	Flame R	96-99	0530				4CW176410200
125	Skyliner	03			0300		5NSE76410000
125-150	Doodo	00->			0300		5DS1764100
125-150	Thunder	01->			0300		5DS1764100
125-150	Skyliner	99->			0300		5DS1764100
150	XC Vertex				0400		3UH1764100
180	Skyliner	03			0570		5XME76410000
250	Skyliner	00-03		0659	0650		5CG176410000
250	Skyliner Abs	03		0659	0650		5CG176410000
300	Kilibre	03			0560		5SEE76410000
PEUGEOT							
50	Buxy	94-97	0160	0169	0162	0161	729171
50	Elyseo	99	0160	0169	0162	0161	729171
50	Elystar Tsdì	03-05	0160	0169	0162	0161	729171
50	Jet Force	03	0160	0169	0162	0161	729171
50	Ludix 10 One	04	0160	0169	0162	0161	729171
50	Ludix 10 Sp Blaster	05-06	0160	0169	0162	0161	729171
50	Ludix 10 Trend - Snake	04	0160	0169	0162	0161	729171
50	Ludix 14 Classic	04	0160	0169	0162	0161	729171
50	Ludix 14 Elegant	04	0160	0169	0162	0161	729171
50	Metal-X	02	0160	0169	0162	0161	729171
50	Sc Metropolis Lm-Sxlm	91	0140			0141	706618
50	Speedake	95-97	0160	0169	0162	0161	729171
50	Speedfight 2 Aria	05-06	0160	0169	0162	0161	729171
50	Speedfight 2 Lc-Silversport	05-06	0160	0169	0162	0161	729171
50	Speedfight Acqua	97-98	0160	0169	0162	0161	729171
50	Speedfight Aria	97-98	0160	0169	0162	0161	729171
50	Speedfight Aria Catalitico	99	0160	0169	0162	0161	729171
50	Squab	95-97	0160	0169	0162	0161	729171
50	Sv Geo	91-95	0150				723590
50	Trekker	98-00	0160	0169	0162	0161	729171
50	Trk2 Wrc	04-06	0160	0169	0162	0161	729171
50	Vivacity	99	0160	0169	0162	0161	729171
50	Vivacity Catalitico	99-02	0160	0169	0162	0161	729171
50	Vivacity Vsx-Xr	02-04	0160	0169	0162	0161	729171
50	X-Fight	00	0160	0169	0162	0161	729171
50	Xrace	03	0160	0169	0162	0161	729171
50	Zenith L	94-96	0150				723590
50	Zenith Ln-Ls	97-98	0130				723590
50	Zenith Ln-Ls	97-98	0150				723590
50	Zenith N	97-98	0150				723590
125	Elyseo	99-00			0420		737830
125	Elyseo 125-150	01			0420		737830
125	Elystar	02-03			0420		737830
125	Jet Force	03-04			0420		737830



CINGHIE TRASMISSIONE DENTATE SCOOTER

COGGED TRANSMISSION BELTS FOR SCOOTER

CC	MODELLO - MODEL	ANNO YEAR	DAYCO			RMS <small>YOUR BEST PARTNER</small>	RIFERIMENTO ORIGINALE OEM NUMBER
			CODICE ORIGINALE ORIGINAL CODE	CONFEZ. INDUSTR. INDUSTRIAL PACKING	RACING POWER PLUS KEVLAR	CODICE ORIGINALE ORIGINAL CODE	
			16 375 (_ _ _ _)				
150	Elyseo	01->			0420	737830	
150	Elystar	02->			0420	737830	
150	Looxor	03->			0400		
250	SV	01->			0780		
250	Geopolis				0790		
250	Satelis				0810		
500	Satelis				0680		
PGO							
50	Big max		1120				
50	Motore Morini		0170				
PIAGGIO SCOOTER							
50	Diesis	01	0250	0259	0252	436864	
50	Fly 2T	10	0060	0069		82712R	
50	Fly 2T	05-07	0060	0069		82712R	
50	Fly 4T	05-08	0840			842907	
50	Fly 4T Mot Chn	06-07	0840			842907	
50	Free	92-94	0010	0019	0012	430728	
50	Free Delivery	00-01	0250	0259	0252	436864	
50	Free Fl	95-02	0010	0019	0012	430728	
50	Free Fl	95-02	0250	0259	0252	436864	
50	Liberty	97-05	0060	0069		82712R	
50	Liberty 2T	06-08	0060	0069		82712R	
50	Liberty 2T Rst	04	0060	0069		82712R	
50	Liberty 2T Sport	06-08	0060	0069		82712R	
50	Liberty 4T	05-08	0060	0069		82712R	
50	Liberty 4T	00-02	0060	0069		82712R	
50	Liberty 4T Delivery Tnt	09	0060	0069		82712R	
50	Liberty 4T Rst	04	0060	0069		82712R	
50	Liberty 4T Sport	06-08	0060	0069		82712R	
50	Liberty Moc 2T	09	0060	0069		82712R	
50	Liberty Moc 4T & Elle	09-10	0060	0069		82712R	
50	Liberty Ptt Eu2	04-05	0060	0069		82712R	
50	Liberty	-			0061		
50	Nrg	94-96	0010	0019	0012	430728	
50	Nrg Extreme	99-00	0250	0259	0252	436864	
50	Nrg Mc3	01-04	0250	0259	0252	436864	
50	Nrg Power Dd	05-09	0250	0259	0252	436864	
50	Nrg Power Dd Serie Spece	07-08	0250	0259	0252	436864	
50	Nrg Power Dt	06-08	0250	0259	0252	436864	
50	Nrg Power Dt Serie Spece	07-08	0250	0259	0252	436864	
50	Nrg Purejet	02-04	0250	0259	0252	436864	
50	Nrg Rst Mc2	98	0250	0259	0252	436864	
50	Nrg Rst Mc2	96-97	0010	0019	0012	430728	
50	Ntt	95-96	0010	0019	0012	430728	
50	Quartz	92-96	0040	0049	0042	0041 431190	
50	Sfera	91-93	0030			0031 286175	
50	Sfera Maquillage 2	94	0040	0049	0042	0041 431190	

CINGHIE TRASMISSIONE DENTATE SCOOTER
COGGED TRANSMISSION BELTS FOR SCOOTER



CC	MODELLO - MODEL	ANNO YEAR	DAYCO			RMS YOUR BEST PARTNER	RIFERIMENTO ORIGINALE OEM NUMBER
			CODICE ORIGINALE ORIGINAL CODE	CONFEZ. INDUSTR. INDUSTRIAL PACKING	RACING POWER PLUS KEVLAR	CODICE ORIGINALE ORIGINAL CODE	
			16 375 (_ _ _ _)				
50	Sfera Rst	95-97	0040	0049	0042	0041	431190
50	Typhoon	01-09	0250	0259	0252		436864
50	Vespa Et2	97-05	0040	0049	0042	0041	431190
50	Vespa Et2 Iniezione	97-00	0050		0052	0051	82645R
50	Vespa Et4	00-05	0050		0052	0051	82645R
50	Vespa Lx 2T	05-08	0050		0052	0051	82645R
50	Vespa Lx 2T FI	09	0050		0052	0051	82645R
50	Vespa Lx 2T Touring	10	0050		0052	0051	82645R
50	Vespa Lx 4T	05-08	0050		0052	0051	82645R
50	Vespa Lx 4T-4V	09	0050		0052	0051	82645R
50	Vespa Lx 4T-4V Touring	10	0050		0052	0051	82645R
50	Vespa Lxv 2T	06-08	0050		0052	0051	82645R
50	Vespa Lxv 2T Navy	08	0050		0052	0051	82645R
50	Vespa S 2T & College	07-10	0050		0052	0051	82645R
50	Vespa S 4T-4V	08-09	0050		0052	0051	82645R
50	Zip	00-04	0050		0052	0051	82645R
50	Zip	92-93	0030			0031	286175
50	Zip	95-96	0040	0049	0042	0041	431190
50	Zip 2T	08-09	0050		0052	0051	82645R
50	Zip 4T	00-08	0050		0052	0051	82645R
50	Zip Bimodale	94-97	0040	0049	0042	0041	431190
50	Zip Fast Raider	93-94	0040	0049	0042	0041	431190
50	Zip Fast Raider Rst	96-97	0040	0049	0042	0041	431190
50	Zip Rst	96-99	0040	0049	0042	0041	431190
50	Zip Sp	01-04	0050		0052	0051	82645R
50	Zip Sp	96-00	0040	0049	0042	0041	431190
50	Zip Sp Eu2	06-09	0050		0052	0051	82645R
100	Zip 4T	06-08	0050		0052	0051	82645R
125	Beverly	01-03			0600		842009
125	Beverly Eu3	07-08			0600		842009
125	Beverly Eu3 Mic	07			0600		842009
125	Beverly Eu3 Sport	07-08			0600		842009
125	Beverly Rst	04-07			0600		842009
125	Beverly Tourer Eu3	08-09			0600		842009
125	Carnaby	07-09			0600		842009
125	Fly	05-07		0389	0380		841213
125	Fly Eu3	07-08		0389	0380		841213
125	Hexagon	94-97			0200		431258
125	Hexagon Gtx	00		0389	0380		841213
125	Hexagon Lx4	98-99	0260				825059
125	Hexagon Lx-Lxt	98-99			0200		431258
125	Liberty	01-02		0389	0380		841213
125	Liberty	98-00	0260				825059
125	Liberty 4T	06-07		0389	0380		841213
125	Liberty 4T Eu3	07-08		0389	0380		841213
125	Liberty 4T Eu3 Delivery	08		0389	0380		841213
125	Liberty 4T Sport Eu3	06-08		0389	0380		841213



CINGHIE TRASMISSIONE DENTATE SCOOTER

COGGED TRANSMISSION BELTS FOR SCOOTER

CC	MODELLO - MODEL	ANNO YEAR	DAYCO			RMS <small>YOUR BEST PARTNER</small>	RIFERIMENTO ORIGINALE OEM NUMBER
			CODICE ORIGINALE ORIGINAL CODE	CONFEZ. INDUSTR. INDUSTRIAL PACKING	RACING POWER PLUS KEVLAR	CODICE ORIGINALE ORIGINAL CODE	
			16 375 (_ _ _ _)				
125	Liberty Moc 4T & Elle	09-10		0389	0380	841213	
125	Liberty Rst	04-05		0389	0380	841213	
125	Liberty Rst Ptt	05-06		0389	0380	841213	
125	Liberty Sport	06		0389	0380	841213	
125	Mp3	07-08		0389	0380	841213	
125	Mp3 Ibrido	09		0389	0380	841213	
125	Mp3 Ie	08-09		0389	0380	841213	
125	Sfera Ii Serie	95-97	0070			475847	
125	Skipper	94-97	0190			434812	
125	Skipper 4T	00-02		0389	0380	841213	
125	Skipper I Serie	94-97			0200	431258	
125	Skipper Lx	98-99	0190			434812	
125	Super Hexagon Gtx 12'''	01-02		0389	0380	841213	
125	Vespa Et4	96-98	0070			475847	
125	Vespa Et4	99-02		0389	0380	841213	
125	Vespa Granturismo	03-07		0389	0380	841213	
125	Vespa Granturismo Eu3	06-07		0389	0380	841213	
125	Vespa Gts 4T Ie Super	09		0389	0380	841213	
125	Vespa Gts Eu3	07-09		0389	0380	841213	
125	Vespa Gtv	07-08		0389	0380	841213	
125	Vespa Gtv 4T Navy Eu3	08		0389	0380	841213	
125	Vespa Lx	05-06		0389	0380	841213	
125	Vespa Lx 4T Fl	09		0389	0380	841213	
125	Vespa Lx Eu3	06-08		0389	0380	841213	
125	Vespa Lx Eu3 Ie	09		0389	0380	841213	
125	Vespa Lx Touring	10		0389	0380	841213	
125	Vespa Lxv 4T Eu3	06-09		0389	0380	841213	
125	Vespa Lxv 4T Navy Eu3	08		0389	0380	841213	
125	Vespa Lxv Ie 4T	10		0389	0380	841213	
125	Vespa S 4T Eu3	07-08		0389	0380	841213	
125	Vespa S 4T Ie & College	09-10		0389	0380	841213	
125	X Evo	07		0389	0380	841213	
125	X7 Eu3	08		0389	0380	841213	
125	X7 Evo Ie Eu3	09		0389	0380	841213	
125	X8	04-06		0389	0380	841213	
125	X8 Premium Eu2	06		0389	0380	841213	
125	X8 Premium Eu3	06-07		0389	0380	841213	
125	X8 Street Eu2	06-07		0389	0380	841213	
125	X9	01-02		0389	0380	841213	
125	X9 Evolution	03-06		0389	0380	841213	
125	X9 Evolution Eu3	07		0389	0380	841213	
125	Zip	00-02		0389	0380	841213	
150	Fly	05-07		0389	0380	841213	
150	Fly Eu3	08		0389	0380	841213	
150	Liberty 4T Eu3	08		0389	0380	841213	
150	Liberty 4T Sport Eu3	08		0389	0380	841213	
150	Liberty Moc 4T	09		0389	0380	841213	

CINGHIE TRASMISSIONE DENTATE SCOOTER
COGGED TRANSMISSION BELTS FOR SCOOTER



CC	MODELLO - MODEL	ANNO YEAR	DAYCO			RMS YOUR BEST PARTNER	RIFERIMENTO ORIGINALE OEM NUMBER
			CODICE ORIGINALE ORIGINAL CODE	CONFEZ. INDUSTR. INDUSTRIAL PACKING	RACING POWER PLUS KEVLAR	CODICE ORIGINALE ORIGINAL CODE	
			16 375 (_ _ _ _)				
150	Vespa Lx	05-06		0389	0380		841213
150	Vespa Lx 4T FI	09		0389	0380		841213
150	Vespa Lx Eu3	06-08		0389	0380		841213
150	Vespa Lx Eu3 le	09		0389	0380		841213
150	Vespa Lx Touring	10		0389	0380		841213
150	Vespa S 4T	08-09		0389	0380		841213
150	Vespa S 4T le & College	09-10		0389	0380		841213
150	X8 Street Eu2	06-08		0389	0380		841213
180	Hexagon Gtx	00		0669	0660		840908
180	Super Hexagon Gtx 12'''	01-02		0669	0660		840908
180	X9 Amalfi	00-03		0669	0660		840908
200	Carnaby	07-08			0690		842011
200	Liberty	06		0669	0660		840908
200	Liberty 4T Eu3	07-08		0669	0660		840908
200	Liberty 4T Sport Eu3	06-07		0669	0660		840908
200	Liberty Rst	04		0669	0660		840908
200	Liberty Sport	06		0669	0660		840908
200	Vespa Granturismo	06-07		0669	0660		840908
200	X8	05-07		0669	0660		840908
200	X9	02-03		0669	0660		840908
200	X9 Evolution	03		0669	0660		840908
250	Beverly	06-07			0790		841851
250	Beverly Cruiser	07-09			0790		841851
250	Beverly Eu3 Mic	07			0790		841851
250	Beverly le Eu3	06-08			0790		841851
250	Beverly Rst	04-05			0790		841851
250	Beverly Sport	06-08			0790		841851
250	Beverly Tourer Eu3	08-09			0790		841851
250	Carnaby	08			0790		841851
250	Mp3	06-08	0810		0812		843963-82941R
250	Mp3 Lt - Mp3 Mic	08-09	0810		0812		843963-82941R
250	Vespa Gt 60 Eu3	06-07	0810		0812		843963-82941R
250	Vespa Gts	05-13	0810		0812		843963-82941R
250	Vespa Gtv	06-09	0810		0812		843963-82941R
250	Vespa Gtv 4T Navy Eu3	07	0810		0812		843963-82941R
250	X7 Eu3	08	0810		0812		843963-82941R
300	Beverly Rst 4T 4V le Eu3	10			0790		841851
300	Beverly Tourer Eu3	09-10			0790		841851
300	Carnaby Cruiser	09			0790		841851
300	Mp3 4T 4V le ERL Ibrido	10-13	0810		0812		843963-82941R
300	Mp3 4T 4V le Lt Ibrido	10-11	0810		0812		843963-82941R
300	Mp3 le Lt	10-11	0810		0812		843963-82941R
300	Mp3 le Lt le Lt Sport	11-13	0810		0812		843963-82941R
300	Mp3 le Lt Touring	11-12	0810		0812		843963-82941R
300	Mp3 le Mic	10-11	0810		0812		843963-82941R
300	Mp3 le Touring	11-12	0810		0812		843963-82941R
300	Mp3 Yourban ERL	11	0810		0812		843963-82941R



CINGHIE TRASMISSIONE DENTATE SCOOTER

COGGED TRANSMISSION BELTS FOR SCOOTER

CC	MODELLO - MODEL	ANNO YEAR					RIFERIMENTO ORIGINALE OEM NUMBER
			CODICE ORIGINALE ORIGINAL CODE	CONFEZ. INDUSTR. INDUSTRIAL PACKING	RACING POWER PLUS KEVLAR	CODICE ORIGINALE ORIGINAL CODE	
			16 375 (_ _ _ _)				
300	Mp3 Yourban Lt ERL	11-12	0810		0812		843963-82941R
300	Vespa Gts Ie	12-13	0810		0812		843963-82941R
300	Vespa Gts Ie Touring	11-12	0810		0812		843963-82941R
300	Vespa Gts Super	08-14	0810		0812		843963-82941R
300	Vespa Gts Super Sport	10-13	0810		0812		843963-82941R
300	Vespa Gtv 4T 4V Ie	10-13	0810		0812		843963-82941R
300	Vespa Gtv Via Montenapoleone	10	0810		0812		843963-82941R
300	X7 Evo Ie Eu3	09-10	0810		0812		843963-82941R
400	Beverly Eu3	06-07			0680		832738
400	Beverly Tourer Eu3	08-09			0680		832738
400	Mp3	07-08			0680		832738
400	Mp3 Lt	09			0680		832738
400	Mp3 Mic	08-09			0680		832738
400	X Evo	07-09			0680		832738
400	X8 Eu3	06-08			0680		832738
500	Beverly	02-06			0680		832738
500	Beverly Eu3	06-08			0680		832738
500	X9 Evolution	03-07			0680		832738
500	X9 Evolution Abs	06-07			0680		832738
SCOOTER CINESI							
50	Scooter carter corto	00				1211	
50	Scooter carter lungo	00				1231	
125	Scooter	00				1231	
150	Scooter	00				1231	
SUZUKI							
50	Address	92-95	0220				27601-09E00-000
50	Katana V-Y	97-00	0320			0321	27601-06F01-000
50	Street Magic	98	0320			0321	27601-06F01-000
50	Zillion	99	0320			0321	27601-06F01-000
250	Burgman K3-K6	03-06			0700		27601-14F11-000
250	Burgman W-K2	98-02			0700		27601-14F11-000
400	An Burgman X-K2	99-02			0710	0713	27601-15F03-000
400	Burgman K7-K9	07-09			0830		27601-05H00-000
SYM							
50	Cinderella	99-02	1180				1B01GAK01
50	Jet	99-01	1060				1B01T5201
50	Jet Euro X Eu2	03-07	1060				1B01T5201
50	Jet Sportx	06-07	1060				1B01T5201
50	Jungle	00	1060				1B01T5201
50	Mask	00-01	1060				1B01T5201
50	Mask Eu2	03-04	1060				1B01T5201
50	Mio	06-09	1170				1B01A1A01
50	Red Devil	99	1060				1B01T5201
50	Super Fancy	98-00	1180				1B01GAK01
100	Cinderella	99-01	1190				1B01A3101
125	Euro Mx	02			1040		1B01H3A01
125	Euro Mx E2	03-04			1040		1B01H3A01

CINGHIE TRASMISSIONE DENTATE SCOOTER
COGGED TRANSMISSION BELTS FOR SCOOTER



CC	MODELLO - MODEL	ANNO YEAR	DAYCO			RMS YOUR BEST PARTNER	RIFERIMENTO ORIGINALE OEM NUMBER
			CODICE ORIGINALE ORIGINAL CODE	CONFEZ. INDUSTR. INDUSTRIAL PACKING	RACING POWER PLUS KEVLAR	CODICE ORIGINALE ORIGINAL CODE	
			16 375 (_ _ _ _)				
125	Hd Eu2	03-04			1090		1B01HHB01
125	Hd Eu3	07-08			1090		1B01HHB01
125	Hd Evo	05-06			1090		1B01HHB01
125	Hd Evo Eu3	07-10			1090		1B01HHB01
125	Hd Evo Tamburo Eu3	08			1090		1B01HHB01
125	Joymax Gts	06-07			1080		1B01HNA01
125	Joyride	01-02			1080		1B01HNA01
125	Joyride Eu2	03-04			1080		1B01HNA01
125	Joyride Eu2	05-06			1080		1B01HNA01
125	Joyride Eu3	07			1080		1B01HNA01
125	Joyride Evo	09-14			1080		1B01HNA01
125	Shark	99-02			1040		1B01H3A01
150	Attila	00-01			1030		1B01H7A01
150	Euro Mx	02			1040		1B01H3A01
150	Euro Mx Eu2	03-04			1040		1B01H3A01
150	Joyride	01-02			1070		1B01H9A01
150	Shark	00-01			1040		1B01H3A01
180	Track Runner	06-07			1200		1B01RA101
200	Hd Eu2	03-04			1100		1B01HHA01
200	Hd Eu3 I	07			1100		1B01HHA01
200	Hd Evo Eu2	05-06			1100		1B01HHA01
200	Hd Evo Eu3 I	07			1100		1B01HHA01
200	Hd Evo I Eu3	10			1100		1B01HHA01
200	Hd Evo I Tamburo Eu3	08			1100		1B01HHA01
200	Joyride	03			1070		1B01H9A01
200	Joyride Eu2	03-04			1070		1B01H9A01
200	Joyride Eu2	05-06			1070		1B01H9A01
250	Gts	07-08			1110		1B01HMA01
250	Joymax	06-07			1110		1B01HMA01
250	Joymax Eu3 I	07			1110		1B01HMA01
YAMAHA							
50	Bw'S	03-04	0080	0089	0082	0081	5RNE76410000
50	Aerox	01-10	0080	0089	0082	0081	5RNE76410000
50	Aerox Eu2	03	0080	0089	0082	0081	5RNE76410000
50	Aerox R	99-00	0080	0089	0082	0081	5RNE76410000
50	Axis	95-96	0110				3WF176410000
50	Breeze	94-95	0110				3WF176410000
50	Bw'S	04-10	0080	0089	0082	0081	5RNE76410000
50	Bw'S Bump	97-98	0080	0089	0082	0081	5RNE76410000
50	Bw'S Naked	03-04	0080	0089	0082	0081	5RNE76410000
50	Bw'S Naked	09	0080	0089	0082	0081	5RNE76410000
50	Bw'S Next Generation	97-05	0080	0089	0082	0081	5RNE76410000
50	Bw'S Next Generation Cat.	99-00	0080	0089	0082	0081	5RNE76410000
50	Bw'S Original	97-02	0080	0089	0082	0081	5RNE76410000
50	Bw'S Original Eu2	03	0080	0089	0082	0081	5RNE76410000
50	Bw'S Original Eu2	02	0080	0089	0082	0081	5RNE76410000
50	Bw'S Original Eu2	02	0080	0089	0082	0081	5RNE76410000



CINGHIE TRASMISSIONE DENTATE SCOOTER

COGGED TRANSMISSION BELTS FOR SCOOTER

CC	MODELLO - MODEL	ANNO YEAR	DAYCO			RMS <small>YOUR BEST PARTNER</small>	RIFERIMENTO ORIGINALE OEM NUMBER
			CODICE ORIGINALE ORIGINAL CODE	CONFEZ. INDUSTR. INDUSTRIAL PACKING	RACING POWER PLUS KEVLAR	CODICE ORIGINALE ORIGINAL CODE	
			16 375 (----)				
50	Ct S	90-95	0090				23Y176410000
50	Ct Ss	92-95	0090				23Y176410000
50	Jog R	02	0080	0089	0082	0081	5RNE76410000
50	Jog R	06-10	0080	0089	0082	0081	5RNE76410000
50	Jog R Eu2	02-05	0080	0089	0082	0081	5RNE76410000
50	Jog Z	95	0410				3GF176410000
50	Neo'S	97-10	0080	0089	0082	0081	5RNE76410000
50	Neo'S Eu2	02-03	0080	0089	0082	0081	5RNE76410000
50	Slider	00-02		0089	0082	0081	5RNE76410000
50	Spy	95-98		0089	0082	0081	5RNE76410000
50	Why - Eu1 - Eu2	98-05		0089	0082	0081	5RNE76410000
100	Ya Aerox - Bw's - Yn Neo's	99-02	0620				4VP176410000
125	Cygnus	95-98	0530				4CW176410200
125	Cygnus R	97-03	0530				4CW176410200
125	Cygnus X	04-10			0870		5ML176410000
125	Majesty	03-09			0300		5NSE76410000
125	X-City	08			0800		1B9E76410000
125	X-Max	06-10			0800		1B9E76410000
150	Fly One	90-95			0400		3UH176410000
150	Fly One R	97-98			0400		3UH176410000
150	Maxster - Majesty - Teo's	00-02			0300		5DS176410000
180	Majesty	03-06			0570		5XME76410000
250	Majesty	96-03		0659	0650		5CG176410000
250	Majesty Abs	03		0659	0650		5CG176410000
250	Majesty Dx	98-99		0659	0650		5CG176410000
250	X-Max	05-12			0560		5SEE76410000
250	X-Cty	09-12			0560		5SEE76410000
300	Versity	03-06			0560		5SEE76410000
400	Majesty	04-06			0770		5RU176410000

CINGHIE TRASMISSIONE DENTATE SCOOTER

COGGED TRANSMISSION BELTS FOR SCOOTER



TABELLA CINGHIE TRASMISSIONE IN ORDINE DI MISURA - ORDER BY LENGHT

Codice RMS RMS CODE	L	S	A	MARCA BRAND	Codice RMS RMS CODE	L	S	A	MARCA BRAND
16 375 0130	652	15,3	8	DAYCO	16 375 0060	826	18,5	8	DAYCO
16 375 0170	664	16,5	8	DAYCO	16 375 0660	826	22	13	DAYCO
16 375 0220	665	16	8	DAYCO	16 375 0190	828	22	9,5	DAYCO
16 375 1211	669	18	8	DAYCO	16 375 0520	828	16,3	8	DAYCO
16 375 0210	670	18	9,7	DAYCO	16 375 0300	832	22,2	9,6	DAYCO
16 375 1180	678	17,5	8	DAYCO	16 375 0420	832	18,5	9,6	DAYCO
16 375 1000	687	17,9	9,4	DAYCO	16 375 0200	834	22	9,5	DAYCO
16 375 1170	688	18,1	8	DAYCO	16 375 0570	834	22	9,7	DAYCO
16 375 0150	700	18	8	DAYCO	16 375 1070	834	18,7	9,5	DAYCO
16 375 1190	722	17,4	9	DAYCO	16 375 0810	835	22,6	14	DAYCO
16 375 0040	724	17,5	8	DAYCO	16 375 0812	835	22,5	13	DAYCO
16 375 1231	729	18	9,2	DAYCO	16 375 1221	835	20	9,7	RMS YOUR BEST PARTNER
16 375 0140	730	15	8	DAYCO	16 375 1302	836	21,7	10	DAYCO
16 375 0052	732	18,5	8	DAYCO	16 375 0280	845	22,5	10	DAYCO
16 375 0030	734	17	8	DAYCO	16 375 0289	845	22,5	10	DAYCO
16 375 0070	736	18	8	DAYCO	16 375 0260	848	18	8	DAYCO
16 375 0332	743	18	8	DAYCO	16 375 0230	860	15	8	DAYCO
16 375 1200	743	18,8	9	DAYCO	16 375 0650	872	23	11,5	DAYCO
16 375 1120	746	17,7	8,5	DAYCO	16 375 0659	872	23	11,5	DAYCO
16 375 0080	747	16,5	8	DAYCO	16 375 0700	893	22,7	11,5	DAYCO
16 375 1060	747	17,5	9	DAYCO	16 375 0720	907	24	11	DAYCO
16 375 0840	756	18	8	DAYCO	16 375 0470	916	22	10,5	DAYCO
16 375 0162	765	17,5	8	DAYCO	16 375 0479	916	22	10,5	DAYCO
16 375 1030	768	19,3	9,5	DAYCO	16 375 0770	916	29,8	15	DAYCO
16 375 0620	770	17,5	8	DAYCO	16 375 0730	918	22,3	10	DAYCO
16 375 0530	778	22	9	DAYCO	16 375 0739	918	22,3	10	DAYCO
16 375 0320	782	18,4	8	DAYCO	16 375 0800	923	22	9,5	DAYCO
16 375 0410	785	16,6	8	DAYCO	16 375 1110	923	23	10,5	DAYCO
16 375 0110	792	16,5	8	DAYCO	16 375 0310	926	22,2	10,2	DAYCO
16 375 0870	792	21,8	9,5	DAYCO	16 375 1090	930	19,5	9,5	DAYCO
16 375 0090	793	15	8	DAYCO	16 375 0600	937	22,3	10,8	DAYCO
16 375 0441	795	20	9,8	RMS YOUR BEST PARTNER	16 375 0710	938	22,7	15	DAYCO
16 375 0442	795	20	9,8	DAYCO	16 375 0713	938	22,7	15	RMS YOUR BEST PARTNER
16 375 0670	796	16,8	8	DAYCO	16 375 0690	940	22	13,5	DAYCO
16 375 0550	800	20	9,6	DAYCO	16 375 1100	940	18,7	10	DAYCO
16 375 1150	800	17,2	9	DAYCO	16 375 0780	946	23,3	11	DAYCO
16 375 1040	803	19	9	DAYCO	16 375 0790	954	22,6	13,2	DAYCO
16 375 0012	804	17,5	8	DAYCO	16 375 0820	996	24	11,5	DAYCO
16 375 0120	808	17	9	DAYCO	16 375 0560	1006	22,8	11,5	DAYCO
16 375 0250	811	18,5	8	DAYCO	16 375 0830	1011	27,7	14,2	DAYCO
16 375 1130	811	19,4	10	DAYCO	16 375 1402	1011	24,6	15	DAYCO
16 375 0380	814	22,5	10,2	DAYCO	16 375 1020	1024	26,7	14	DAYCO
16 375 0389	814	22,5	10,2	DAYCO	16 375 0880	1025	8,7	14,8	DAYCO
16 375 0400	815	22	10	DAYCO	16 375 0680	1036	28	14,2	DAYCO
16 375 1080	815	19,7	9,3	DAYCO					
16 375 1140	815	19,2	10	DAYCO					
16 375 0580	816	18,8	9,4	DAYCO					
16 375 0630	820	18	8,2	DAYCO					
16 375 0180	823	16,9	8	DAYCO					
16 375 0390	823	17,8	9	DAYCO					

LEGENDA MISURE - MEASURES LEGEND

L = Lunghezza Cinghia - Belt length

S = Spessore Cinghia - Belt tickness

A = Altezza dente - Tooth height

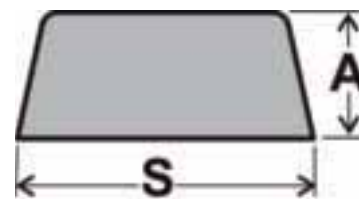

(Misure Fornite dal Costruttore - Measures from supplier)



CINGHIE TRASMISSIONE DENTATE SCOOTER

COGGED TRANSMISSION BELTS FOR SCOOTER

TABELLA CINGHIE TRASMISSIONE IN ORDINE DI CODICE - ORDER BY CODE

Codice RMS RMS CODE	L	S	A	MARCA BRAND	Codice RMS RMS CODE	L	S	A	MARCA BRAND
16 375 0012	804	17,5	8	DAYCO	16 375 0660	826	22	13	DAYCO
16 375 0030	734	17	8	DAYCO	16 375 0670	796	16,8	8	DAYCO
16 375 0040	724	17,5	8	DAYCO	16 375 0680	1036	28	14,2	DAYCO
16 375 0052	732	18,5	8	DAYCO	16 375 0690	940	22	13,5	DAYCO
16 375 0060	826	18,5	8	DAYCO	16 375 0700	893	22,7	11,5	DAYCO
16 375 0070	736	18	8	DAYCO	16 375 0710	938	22,7	15	DAYCO
16 375 0080	747	16,5	8	DAYCO	16 375 0713	938	22,7	15	RMS YOUR BEST PARTNER
16 375 0090	793	15	8	DAYCO	16 375 0720	907	24	11	DAYCO
16 375 0110	792	16,5	8	DAYCO	16 375 0730	918	22,3	10	DAYCO
16 375 0120	808	17	9	DAYCO	16 375 0739	918	22,3	10	DAYCO
16 375 0130	652	15,3	8	DAYCO	16 375 0770	916	29,8	15	DAYCO
16 375 0140	730	15	8	DAYCO	16 375 0780	946	23,3	11	DAYCO
16 375 0150	700	18	8	DAYCO	16 375 0790	954	22,6	13,2	DAYCO
16 375 0162	765	17,5	8	DAYCO	16 375 0800	923	22	9,5	DAYCO
16 375 0170	664	16,5	8	DAYCO	16 375 0810	835	22,6	14	DAYCO
16 375 0180	823	16,9	8	DAYCO	16 375 0812	835	22,5	13	DAYCO
16 375 0190	828	22	9,5	DAYCO	16 375 0820	996	24	11,5	DAYCO
16 375 0200	834	22	9,5	DAYCO	16 375 0830	1011	27,7	14,2	DAYCO
16 375 0210	670	18	9,7	DAYCO	16 375 0840	756	18	8	DAYCO
16 375 0220	665	16	8	DAYCO	16 375 0870	792	21,8	9,5	DAYCO
16 375 0230	860	15	8	DAYCO	16 375 0880	1025	8,7	14,8	DAYCO
16 375 0250	811	18,5	8	DAYCO	16 375 1000	687	17,9	9,4	DAYCO
16 375 0260	848	18	8	DAYCO	16 375 1020	1024	26,7	14	DAYCO
16 375 0280	845	22,5	10	DAYCO	16 375 1030	768	19,3	9,5	DAYCO
16 375 0289	845	22,5	10	DAYCO	16 375 1040	803	19	9	DAYCO
16 375 0300	832	22,2	9,6	DAYCO	16 375 1060	747	17,5	9	DAYCO
16 375 0310	926	22,2	10,2	DAYCO	16 375 1070	834	18,7	9,5	DAYCO
16 375 0320	782	18,4	8	DAYCO	16 375 1080	815	19,7	9,3	DAYCO
16 375 0332	743	18	8	DAYCO	16 375 1090	930	19,5	9,5	DAYCO
16 375 0380	814	22,5	10,2	DAYCO	16 375 1100	940	18,7	10	DAYCO
16 375 0389	814	22,5	10,2	DAYCO	16 375 1110	923	23	10,5	DAYCO
16 375 0390	823	17,8	9	DAYCO	16 375 1120	746	17,7	8,5	DAYCO
16 375 0400	815	22	10	DAYCO	16 375 1130	811	19,4	10	DAYCO
16 375 0410	785	16,6	8	DAYCO	16 375 1140	815	19,2	10	DAYCO
16 375 0420	832	18,5	9,6	DAYCO	16 375 1150	800	17,2	9	DAYCO
16 375 0441	795	20	9,8	RMS YOUR BEST PARTNER	16 375 1170	688	18,1	8	DAYCO
16 375 0442	795	20	9,8	DAYCO	16 375 1180	678	17,5	8	DAYCO
16 375 0470	916	22	10,5	DAYCO	16 375 1190	722	17,4	9	DAYCO
16 375 0479	916	22	10,5	DAYCO	16 375 1200	743	18,8	9	DAYCO
16 375 0520	828	16,3	8	DAYCO	16 375 1211	669	18	8	RMS YOUR BEST PARTNER
16 375 0530	778	22	9	DAYCO	16 375 1221	835	20	9,7	RMS YOUR BEST PARTNER
16 375 0550	800	20	9,6	DAYCO	16 375 1231	729	18	9,2	RMS YOUR BEST PARTNER
16 375 0560	1006	22,8	11,5	DAYCO	16 375 1302	836	21,7	10	DAYCO
16 375 0570	834	22	9,7	DAYCO	16 375 1402	1011	24,6	15	DAYCO
16 375 0580	816	18,8	9,4	DAYCO					
16 375 0600	937	22,3	10,8	DAYCO					
16 375 0620	770	17,5	8	DAYCO					
16 375 0630	820	18	8,2	DAYCO					
16 375 0650	872	23	11,5	DAYCO					
16 375 0659	872	23	11,5	DAYCO					

LEGENDA MISURE - MEASURES LEGEND

L = Lunghezza Cinghia - Belt length

S = Spessore Cinghia - Belt thickness

A = Altezza dente - Tooth height

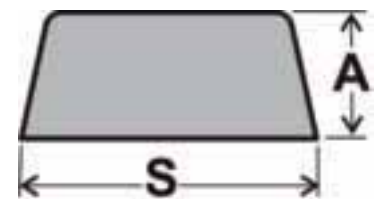

(Misure Fornite dal Costruttore • Measures from supplier)



CINGHIE MISCELATORE SCOOTER - MIXER BELTS FOR SCOOTER MARCA MODELLO - TRADEMARK MODEL		RMS	DAYCO	CODICE ORIGINALE ORIGINAL CODE
GILERA: Dna-Easy Moving • Ice • Runner • Poggiali • FL • Purejet • Storm • Stalker-Typhoon • X • Xr PIAGGIO: Free Delivery 00-01 • Ntt 95-96 • Nrg 94-96 • Diesis 01 • Free 92-94 • FL 95-00 • Liberty 97-02 • Rst Mc2 96-98 • Mc3 01-02 • Nrg Extreme 99-00 • Purejet 02 • Quartz 92-96 • Fly 2T • Sfera Maquillage 2 94 • Sfera base 91-93 • Typhoon 01 • Vespa Et2 97-01 • Zip 00 • Base 92-96 • Rst 96-99 • Zip Fast Raider 93-94 • Zip Sp 96-02 Eu1	50	16 377 0011		286162
GILERA: Typhoon-X-Xr • Runner Fx-Fxr PIAGGIO: Hexagon 125-150 • Lx-Lxt 125-180 • Skipper-Lx 125-150 • Skr City 80	125-180	16 377 0021		431370
CINGHIE INIETTORE SCOOTER - INJECTION BELTS FOR SCOOTER				
PIAGGIO: Vespa Et2 iniezione 5-98>	50		16 377 0040	480135
CINGHIE PIAGGIO APE - V-BELTS APE				
Ape Car P2-P3 78-85 • Mp P501-P601 78-96 • Tm P602 • 82-83 • Tm P703-P703V-FL2 84-01		16 373 0021		113256
CINGHIE TRASMISSIONE CICLOMOTORE PIAGGIO-V-BELTS MOPED				
Ciao monomarcia Mix Teen-Px FL Kat		16 373 0071		102905
Si-Si-FL2-Mix-Boss-Boxer-monomarcia		16 373 0041		124593
Si-Boss-Boxer con variatore		16 373 0031		122192
Bravo mono		16 373 0061		130938
Bravo con variatore		16 373 0051		130937



GIRANTI FRIZIONE MAXI SCOOTER
MAXI SCOOTER CLUTCH ASSY

APRILIA

10 036 0010 

125: Mojito Retrò • Custom 99-01
 (R.O. AP8550407)



10 036 0030 

125: Sr 99-01
 (R.O. AP8550113)



10 036 0130 

125: Leonardo 99-01 • Leonardo St 01-04 •
 Scarabeo Mot. Rotax 99-03
 (R.O. AP0259739)



10 036 0380 

125: Atlantic Eu3 06-12 • Mojito 03-08
 Sport City Street 12 • Sport City Cube 08-10
 Sport City One 4T Eu3 >25-08-09
 Sport City Eu3 06-08 • Sr Max 11
 Scarabeo Light 07-08
 (R.O. CM144005
 B013246)



10 036 0520 

125: Sr Motard 12-13 • Sport City One 4T Eu3
 25-08-09>
 (R.O. CM1612015)



10 036 0140 

150: Leonardo 96-01 • Leonardo St 01-04
 • Scarabeo Mot. Rotax 99-03
 (R.O. AP0259738)



10 036 0330 

200: Atlantic 03-05 • Scarabeo 03 • Scarabeo
 Eu3 06-07 • Sport City 04-06 • Sport City Cube
 08-10 • Sport City Eu3 06-08
 (R.O. CM1440075)

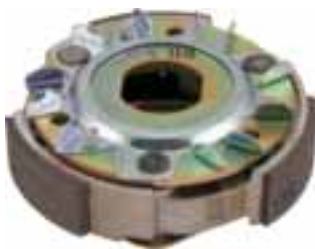

10 036 0410 

250: Atlantic 03-05 • Atlantic Eu3 06-08 • Sca-
 rabeo 04-06 • Scarabeo Light 06-08 • Sport City
 Cube 08-10 • Sport City Eu3 06-08
300: Scarabeo Light 09 • Sport City Cube 08-10
 (R.O. 8722515)



10 036 0420 

400: Scarabeo Light 06-08
 (R.O. 8488445)



10 036 0310 

500: Atlantic Sprint 05-08
 • Scarabeo Light 06-08
 (R.O. 8405775)



10 036 0320 

500: Atlantic 01-04
 (R.O. AP8560053)





BENELLI

10 036 0020

125: Adiva 01-02
(R.O. R13440631A0)



10 036 0060

125: Velvet 99-01 • Velvet Touring 02-03
(R.O. R16141031A0)



DERBI

10 036 0380

125: Boulevard Eu3 04-07 • Gp1 Eu2 06
Rambla 08-09 • Rambla E3 2 Ver 08
150: Boulevard Eu 3 04-07
(R.O. CM144005)

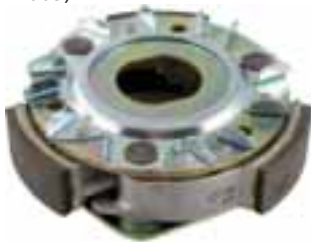

10 036 0020

125: Boulevard 02-04
150: Boulevard 02-04
(R.O. 829184)



10 036 0520

125: Boulevard 4T Eu3 08-12 • Sonar 4T 09-11
Variant Sport 4T E3 12
150: Sonar 4T 09
(R.O. CM1612015)



10 036 0050

200: Boulevard 05
(R.O. CM144012)



10 036 0410

250: Rambla 08
(R.O. 8722515)



GILERA

10 036 0030

125: Runner Fx • Fxr 97-02
Typhoon 95-98 • Typhoon X • Xr 99-00
(R.O. 485442)



10 036 0380

125: Runner 4T St Eu3 08-12 • Runner Vx 4T
Eu3 06-07 • Vx Race 06 • Vx Sc 06-07 • Vx 02-06
Nexus Eu3 07-08 • Nexus Eu3 le 08-10
(R.O. CM144005)

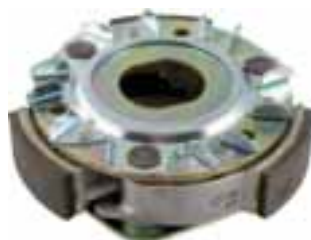

10 036 0020

125: Dna 01 • Runner Vx • Vxr 00-01
(R.O. 829184)





GIRANTI FRIZIONE MAXI SCOOTER
MAXI SCOOTER CLUTCH ASSY

GILERA

10 036 0040 

180: Runner Fx • Fxr 97-02
 (R.O. 4837595)



10 036 0050 

180: Dna 01 • Runner Vx • Vxr 00-01
 (R.O. 827394)



10 036 0330 

200: Runner Vxr 05-06 • Runner Vxr 4T St Eu3
 08 • Runner Vxr Eu3 07 • Runner Vxr Race 06 •
 (R.O. AP8575014)

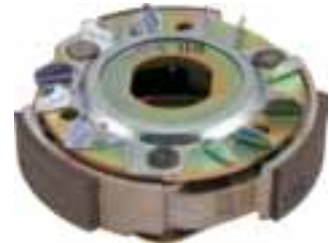

10 036 0410 

250: Nexus Eu3 06
 (R.O. CM1440175)



10 036 0310 

500: Nexus Eu3 06-09
 (R.O. 8405775)



10 036 0420 

500: Nexus 03-05
 (R.O. 8488445)



HONDA

10 036 0100 

250: Foresight 98-00
300: Sh I 07-08



10 036 0160 

125: Chiocciola 00-06 • Dylan 01-06 • Nes 00-
 07 • Sh 01-08 • Sh 125I 01-08
150: Chiocciola 00-06 • Dylan 01-06 • Nes 00-
 07 • Sh 01-08 • Sh 150I 01-08



10 036 0161 

125: Chiocciola 00-06 • Dylan 01-06 • Nes 00-
 07 • Sh 01-08 • Sh 125I 01-08
150: Chiocciola 00-06 • Dylan 01-06 • Nes 00-
 07 • Sh 01-08 • Sh 150I 01-08



ITALJET

10 036 0010 

125: Torpedo 98-00
 (R.O. 210483833)



10 036 0020 

125: Jet Set 4T • Torpedo (Mot. Leader) 00-03 •
 (R.O. 210827981)



10 036 0040 

180: Dragster 99-03





KYMCO

10 036 0160

125: Agility 4T Eu3 06-08 • Agility 4T 06 • Agility Carry 11 • Agility R16 08-12 • Agility Rs 09 • Downtown I 125 09 • Grand Dink Eu2 03-04 • Grand Dink 01-02 • Heroism 95-97 • K-Xct I 12-14 • Like Lx 12 • Like 09 • Movie Eu3 06-07 • Movie XL Eu2 03-04 • Movie XL 01 • Movie 99-00 • People Eu2 03 • People 99-00 • People Eu3 07-11 • People Eu3 08 • People Eu3 11 • People One I 13 • People S Dd Eu3 07-08 • People S 05 • Super 8 08-09 • Vivio 00 • **150:** Agility R16 08-09 • Heroism 95-97 • Movie Eu3 06-07 • **200:** Agility 200 I R16 10 • Agility I Plus 14 • Agility R16 12 • Like 2001 09 • Like Lx 12 • People S 2001 07 • People S 05
(R.O. 00127801)



10 036 0170

125: B&W 00 • Dink 97-98 • Dink Classic 02 • Dink Classic Eu2 03 • Dink Lx 98-00 • Grand Dink 01-02 • Grand Dink Eu2 03-04
150: B&W 00 • Dink 97-98 • Dink Classic 02 • Dink Classic Eu2 03 • Dink Lx 98-00
(R.O. 127961)



10 036 0360

200: Downtown 10 • People Gti 10-11
Downtown Abs I 11 • Downtown I 11
250: B&W 00 • B&W Eu2 00-03 • Grand Dink 01-02 • Grand Dink Eu2 03-04 • People Lc 03-04 • People S 06 • People S I 07 • X Citing 05 • X Citing I 06-07 • Yup 03
300: People S I 08 • X Citing I 08 • X Citing I R 08-09 • Downtown 09 • Abs 10 • People Gti 10
(R.O. 127965)



10 036 0480

50: Agility 4T R10 06-08 • Agility 4T R12 05-08 • Agility 4T R16 08-12
(R.O. 00105099)



10 036 0490

50: B&W Eu2 03 • B&W 02 • Cx 93 • Dink Classic Eu2 03 • Dink Lc 98-02 • Dj W • Dj X • Dj Y • Fever 2X 99-00 • Fever 2X Eu2 03-04 • Maxxer 05 • Mxu 06-07 • People Eu2 03 • People S 05-08 • People S 4T 06-08 • People 04 • Super9 Eu2 03-04 • Super9 00 • Vitality 2T 04
(R.O. 00107100C)



10 036 0530

125: Downtown I 09 • K-Xct I 12 • People Gti 10
125-150: B&W Eu 2 03-04
(R.O. 00122170)



MALAGUTI

10 036 0060

125: Madison 99-01 • Madison R Rst 02
(R.O. 73503300)



10 036 0160

125-150: Ciak 00-01 • Ciak Master 04 • Ciak Rst Eu2 03
(R.O. 53500200)



10 036 0090

150: Madison T 99-01
(R.O. 73503600)





GIRANTI FRIZIONE MAXI SCOOTER
MAXI SCOOTER CLUTCH ASSY

MBK

10 036 0060 

125: Xq Thunder 01-02 • Yp Skyliner 98-02
 (R.O. 5DSE66200000)



10 036 0090 

150: Xn Doodo 01-02 • Xq Thunder 01-02 • Yp Skyliner 00-02
 (R.O. 5KDE66200000)



10 036 0070 

250: Yp Skyliner 00-03 • Yp Skyliner Abs 03
300: Xc Kilibre 03
 (R.O. 5GM166200100)



PEUGEOT

10 036 0360 

125: Yp Skyliner 98-02 • Xq Thunder 01-02
 (R.O. 5DSE66200000)



10 036 0300 

100: Elyseo 99-01 • Speedfight 97-00 • Vivacity 99-01 • X-Fight 00-01
 (R.O. 754144)



10 036 0100 

250: Sv 01-02
 (R.O. 754982)



PIAGGIO

10 036 0010 

125: Hexagon Lx4 98-99 • Liberty 98-00 • Sfera 95-97 • Vespa Et4 96-98
 (R.O. 4838335)



10 036 0020 

125: Beverly 01-03 • X8 04 • X9 Evolution 03
 (R.O. 829184)



10 036 0030 

125: Hexagon 94-97 • Hexagon Lx • Lxt 98-99 • Skipper 94-97 • Skipper Lx 98-99
150: Hexagon 94-97 • Skipper 94-97
 (R.O. 485442)





PIAGGIO

10 036 0380 

125: Beverly Eu3 / Sport 07-08 • Beverly Rst 04-07 • Beverly Rst 4t 4V le Eu3 10-13 • Beverly Tourer Eu3 07-10 • Beverly Eu3 Mic 07 • Carnaby 07-10 • Fly Eu3 08-11 • Hexagon Gtx 00 • Liberty 4T Eu3 Delivery - Single 07-12 • Liberty 4T Eu3 Delivery - Tnt 08-09 • Liberty 01-02 • Liberty Rst 04-05 • Mp3 07-08 • Mp3 le Touring 11-12 • Mp3 Yourban ERL 11-12 • Mp3 Ibrido 09-10 • Mp3 le 08-09 • Skipper 4T 00-02 • Super Hexagon Gtx 12" 01-02 • Vespa Gts Eu3 07-12 • Vespa Gts 4T le Super 09-13 • Vespa Et4 99-02 • Vespa Gran Turismo / Eu3 03-07 • Vespa Gtv 07-08 • Vespa Gtv 4T Navy Eu3 08 • X Evo 07-12 • X10 4T 4V le Eu3 12-13 • X7 Eu3 08 • X7 Evo le Eu3 09-10 • X8 Premium Eu2/3 06-07 • X8 05-06 • X9 Evolution / Eu3 05-07 • X9 01-02 • Zip 00-02
150: Vespa Lx Eu3 le 09-11 • Vespa S4 le e College 09-12
(R.O. CM144005 - B013246)

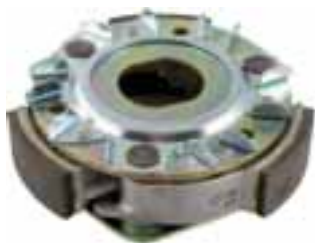

10 036 0510 

125: Fly 4T 3V le Eu3 Lem 12 • Vespa 946 4T 3V Abs 13 • Vespa Lx 4T 3V le - Touring 12-13 • Vespa S4T 3V le 12
150: Vespa Lx 4T 3V le - Touring 12-13
(R.O. CM1672015)



10 036 0520 

125: Fly / Eu3 05-07 • Liberty 4T 06-07 • Liberty Eu3 07-08 • Liberty 4T Sport Eu3 06-08 • Liberty 4T 2V le Eu3 09-12 • Liberty Rst Ptt 05-11 • Liberty Sport 06 • Typhoon 4T 2V Eu3 10-11 • Vespa Lx 4T Eu3 Touring 10-11 • Vespa Lx 4T FL 09 • Vespa Lx Eu3 le 09-10 • Vespa Lx Eu3 06-08 • Vespa Lx 05-06 • Vespa Lx V le 4T 10-12 • Vespa Lxv 4T Eu3 06-09 • Vespa Lx 4T Navy Eu3 08 • Vespa S 4T Eu3 07-08 • Vesp S4 T le e College 09-11 • X8 Street Eu2 06-07
150: Fly 05-07 • Fly Eu3 08-11 • Liberty Moc 4T Eu3 09-13 • Liberty 4T Eu3 08 • Liberty 4T Sport Eu3 08 • Vespa Lx Touring 10-12 • Vespa Lx 05-06 • Vespa Lx Eu3 06-08 • Vespa Lx 4T FL 09 • Vespa S 4T 08-09 • X8 Street Eu2 06-08
(R.O. CM1612015-CM144025)



10 036 0040 

180: Hexagon Lx • Lxt 98-99
(R.O. 4837595)



10 036 0050 

180: Hexagon Gtx 00 • S. Hexagon Gtx 12 01-02
200: Liberty 06 • Liberty 4T Eu3 07-08 • Liberty 4T Sport Eu3 06-07 • Liberty Rst 04 • Liberty Sport 06
(R.O. CM144012)



10 036 0330 

200: Beverly 01-03 • Carnaby 07-08 • Vespa Granturismo 06-07 • X8 05-07
(R.O. CM1440075)

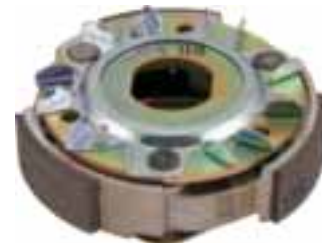

10 036 0100 

250: X9 00-01
(R.O. 496302)



10 036 0410 

250: Beverly 06-07 • Beverly Cruiser 07-09 • Beverly Eu3 Mic 07 • Beverly le Eu3 06-08 • Beverly Rst 04-05 • Beverly Sport 06-08 • Beverly Tourer Eu3 08-09 • Carnaby 08 • Mp3 06-08 • Mp3 Lt 09 • Mp3 Mic 08-09 • Vespa Gt 60 Eu3 06-07 • Vespa Gts • Gts Abs 05-09 • Vespa Gtv 06-09 • Vespa Gtv 4T Navy Eu3 08 • X7 Eu3 08 • X8 Eu3 05-08 • X9 Evolution 06 • Xevo 07
300: Beverly 300 le Tourer 09 • Carnaby Cruiser 09 • Vespa Gts Super 08 • X7 Evo le Eu3 09
(R.O. 8722515)



10 036 0420 

400: Beverly Eu3 06-07 • Beverly Tourer Eu3 08-09 • Mp3 07-08 • X Evo 07-09 • X8 Eu3 06-08
(R.O. 8488445)





GIRANTI FRIZIONE MAXI SCOOTER
MAXI SCOOTER CLUTCH ASSY

PIAGGIO

10 036 0310

500: Beverly 02-06 • Beverly Cruiser 07-11 •
 Beverly Eu3 06-08 • X9 Evolution 06-07 • X9
 Evolution Abs 06-07
 (R.O. 8405775)



10 036 0320

500: X9 01-02
 (R.O. 826053)



SUZUKI

10 036 0370

125: Burgman K2 - K6 02-06
 (R.O. 2150120E60000)



10 036 0430

125: Burgman K7 - L0 07-10 • Burgman L1 11
 • Sixteen K8 - L0 08-10 • Sixteen L1 11
 (R.O. 21501-46G10-000)



10 036 0440

150: Sixteen K8 - L0 08-10 • Sixteen L1 11
 (R.O. 21501-46G20-000)



10 036 0120

250: Burgman W - K2 98-02
 (R.O. 21501-14F02-000)



10 036 0110

400: Burgman K3 - K6 03-06 • Burgman X - K2
 99-02
 (R.O. 2150115F01000)



10 036 0450

200: Burgman 07-10
 (R.O. 21501-03H30-000)



10 036 0460

400: Burgman 07-10
 (R.O. 21501-05H20-000)





SYM

10 036 0160 

10 036 0161 

125: Joyride Eu2 05-06 • Joyride Eu3 07
Joyride Evo 09

180: Track Runner 06-07
(R.O. 22300RA1000)



YAMAHA

10 036 0390 

125: Vpx-City 08 • Yp R X X-Max 06-09
(R.O. 1B9E66200000)



10 036 0090 

150: Xn Teos 01-02 • Xq Maxster 01-02 • Yp
Majesty 01-02
(R.O. 5KDE66200000)



10 036 0070 

250: Vp X City 07-10 • Yp R Black X X-Max 09
• Yp R X • Max 06-10
250: Majesty 2000 >03
300: Xc Versity 03-06
(R.O. 5GM166200100)



10 036 0350 

400: Yp Majesty 04-06
(R.O. 5RU166201000)



10 036 0060 

125: Yp Majesty 98-02 • Xq Maxter 01-02
(R.O. 5DSE66200000)



10 036 0400 

400: Yp Majesty 07-08 • Yp Majesty Abs 07-08
(R.O. 5RU166202000)





GIRANTI FRIZIONE RACING 50 CC

RACING CLUTCH ASSY 50 CC

10 036 0190 

RACING REGOLABILI SCOOTER 50
ADJUSTABLE SCOOTER 50 < 1998
Per motori **MINARELLI-YAMAHA**
Fino al 12/97 - Ø 105



10 036 0200 

RACING REGOLABILI SCOOTER 50
ADJUSTABLE SCOOTER 50 > 1998
Per motori **MINARELLI-YAMAHA 50** Dal '98
GILERA - PIAGGIO - Ø 107



10 036 0210 

Ø 105
RACING MASSE ALLEGGERITE
RACING LIGHT BRAKE SHOES
Per **MOTORI MINARELLI-YAMAHA**
< 1998



10 036 0220 

Ø 107
RACING MASSE ALLEGGERITE
RACING LIGHT BRAKE SHOES
Per motori **MINARELLI-YAMAHA 50**
GILERA - PIAGGIO
> 1998





10 036 0230 

MBK-YAMAHA-MINARELLI 50 >1998
GILERA PIAGGIO 50 - Ø 107



10 036 0240 

MBK-YAMAHA-MINARELLI 50
Fino al 1997 - Ø 105



10 036 0250 

MOTORI FRANCO MORINI 50 Ø 110
ATALA - CAGIVA - DERBY - ITALJET
MALAGUTI - MBK - SUZUKI - YAMAHA



SET CAMPANE GIRANTE - CLUTCH BELL KITS

10 037 0010 

HONDA 125-150: SH • Nes Chiocciola
• Dylan • Phanteon 4T
KIMCO 125: Heroism • Movie 99-00 • Movie XL
99-00 • People 99-00 • People Eu2 03 • Vivio 00
150 Heroism 95-97 • Movie XL Eu2 03 • People
99-00 • People Eu2 03 • Vivio 00
MALAGUTI 125-150: Ciak 00-02 • Ciak
Restyling Eu2 03 • Ciak Master 04



10 037 0020 

HONDA 250: Foresight 98>
300: Sh I 07-08
PEUGEOT 250: Sv 01-02
PIAGGIO 250: X9 00-01





CAMPANE FRIZIONE
CLUTCH BELLS

APRILIA

10 026 0010 

50: Mojito 04-08 • Scarabeo 2T Eu2 Mot. Piaggio 10-11 • Scarabeo 2T Net 09-10 • Scarabeo 4T 4V Net 09-10 • Scarabeo 4T 4V 10 • Scarabeo 4T Restyling Eu3 06-09 • Scarabeo Quattro 09 • Scarabeo Street 2T Restyling 06-09 • Sport City One 2T 4T 08-10 • Sr R Factory ie e Carburatore 10-11 • Sr R, R Factory 04-09
100: Scarabeo 4T Net Eu3 10 • Scarabeo 4T Net 10 • Scarabeo 4T Restyling 06-09 • Scarabeo 4T 10 (R.O. AP8551021-289933)



10 026 0020 

50: Amico Tutti i Modelli - *All models* 90> Rally Lc 95-96 • Scarabeo 94-95 (R.O. AP8206135)



10 026 0030 

50: Sr Tutti i Modelli - *All models* 96>



10 026 0040 

125: Mojito Retrò Custom 99-01 (R.O. AP8550351)



10 026 0050 

125: Atlantic 03-05 • Scarabeo 04-06 Scarabeo Eu3 06-07 (R.O. AP8577095)



10 026 0170 

400: Atlantic Sprint 05-08 • Scarabeo Light 06-08
500: Atlantic Sprint 05-08 • Scarabeo Light 06-08 (R.O. AP8560026)



10 026 0180 

MOTORE ROTAX - ROTAX ENGINE
125: Leonardo 96-01 • Leonardo St 01-04 • Scarabeo Mot Rotax 99-03 • **150:** Leonardo St 01-04 • Scarabeo Mot Rotax 99-03
200: Scarabeo Mot Rotax 99-03 (R.O. AP0259662)



10 026 0190 

125: Atlantic Eu3 06-08 • Sport City 04-06 • Sr Max 11
200: Sport City 04-06 • Sport City Cube 08
250: Atlantic Eu3 06-08 • Sport City Cube 06-08
300: Scarabeo Light 09 • Sport City Cube 08 Sr Max 11 (R.O. 8440494)



BETA

10 026 0020 

50: Chrono 93-94 • Quadra 94>



10 026 0030 

50: Ark 96> • Chrono 96>





DERBI

10 026 0010 

50: Atlantis 2T Eu2 07-09 • Atlantis 2T 10 Atlantis 4T Eu2 07 • Atlantis 4T 04-06 • Atlantis 02 Bullet 03-05 • Atlantis 02 City 03-06 • Atlantis 02 Red Bullet 03 • Atlantis 02 Two Chic 05 Atlantis 02 • Boulevard 2T 09 • Boulevard 4T Eu2 25 Km/h 09 • Gp1 Eu2 05 • Gp1 Open Eu2 06-09 • Gp1 Race Eu2 05-07 • Gp1 01-02 • Gp1 03 • Sonar 2T 09
100: Atlantis 4T 04-06 • Boulevard 4T 10 (R.O. 289933)



10 026 0050 

125-150: Boulevard Eu3 04-07 Boulevard 02-04
200: Boulevard 05 (R.O. 82517R)



10 026 0190 

125: Boulevard 4T Eu3 08-09 • Rambla 08 • Gp1 Eu2 06 • Gp1 Low Seat Eu3 07-08
150: Boulevard 4T Eu3 10
250: Rambla 08 • Gp1 Low Seat Eu3 07-08 Gp1 06-07
300: Rambla 10 (R.O. 8440494)



GILERA

10 026 0010 

50: Dna 00-02 • Easy Moving 95-96 • Ice 01-05 • Runner 97-00 • Stalker 97-08 • Storm 94-95 • Typhoon 94-97 (R.O. 289933)



10 026 0050 

125: Dna 01 • Runner Vx-Vxr 02-04
180: Dna 01 • Runner Vx • Vxr 00-04 (R.O. 82517R)



10 026 0170 

500: Fuoco 07-09 • Nexus 03-05 (R.O. 825176)



10 026 0190 

125: Nexus Eu3 07-08 • Runner Vx Sc 06-07
200: Runner Vxr 05-06 • Runner Vxr Eu3 07
250: Nexus Eu3 06 • Oregon 06-08
300: Nexus Eu3 09 (R.O. 8440494)





CAMPANE FRIZIONE
CLUTCH BELLS

HONDA

10 026 0110



125-150: Chiocciola 00-06 • Dylan 01-06 • Nes 00-07 • Pantheon 2T 98-02
Sh 125 01-08 Sh 125 L 01-08

10 026 0210



250: Foresight 98> • Jazz 00-04
300: Sh 300i Abs 07> • Sh i 07-08
(R.O. 22100-KFG-000)



ITALJET

10 026 0020



MOTORI MINARELLI - MINARELLI ENGINE
50: Bazooka 91> • Pista 92>



KYMCO

10 026 0110



125: Agility Carry 11-11 • Agility R16 09-09 •
Agility R16 12-12 • Agility Rs 09-09 • Down-
town i 09-09 • K-Xct i 12-14 • Like Lx 12 • Like
09-09 • People Eu3 11 • People One i 13-13 •
People S Dd Eu3 07-08 • People S 05 • Super 8
08 • Super 8 09-09 • Agility R16 08
150: Agility R16 09
200: Agility i R16 10 • Agility i Plus 14 • Agility
R16 12 • Like i 09 •
Like Lx 12 • People S 05



MALAGUTI

10 026 0020



50: Centro 92> • F 10 (All Models) 92-96



10 026 0030



50: Centro SL 98> • F 10 97>
• F 12 Phantom Aria (Da Telaio 405188) 97>
• F 15 Firefox 98> • Yesterday 97>



10 026 0110



125-150: Ciak 00-01 • Ciak Master 04
• Ciak Rst Eu2 03
(R.O. 52601300)





MBK

10 026 0020 

MOTORI MINARELLI - MINARELLI ENGINE Ø 105
50: Booster <94 • Booster Ng 95>
• Booster Spirit 96> • Rocket 96> • Sorriso <96
(R.O. 72601700)

10 026 0030 

MOTORI MINARELLI - MINARELLI ENGINE Ø 107
50: Booster All Models 97> • Nitro 97>
• Ovetto 97> • Sorriso 97>
(R.O. 72602700)

10 026 0080 

250: Yp Skyliner 00-03 • Yp Skyliner Abs 03
300: Xc Kilibre 03
(R.O. 5GM166110000)



PEUGEOT

10 026 0210 

250: Sv 01-02



PIAGGIO

10 026 0010 

50: Diesis 01 • Fly 2T-4T 05-07 • Free 92-94 • Liberty 97-05 • Nrg 94-96 • Quartz 92-96
Typhoon 01-09 • Vespa Et2-Et4 97-05 • Zip 95-04
100: Fly 4T 06-08 • Free 02-03 • Zip 4T 06-08
125: Vespa S 4T Le 09
(R.O. 289933)

10 026 0040 

125: Hexagon Lx4 98-99 • Liberty 98-00 • Sfera 95-97 • Vespa Et4 96-02
(R.O. 82503R)

10 026 0050 

125: Beverly 01-03 • X8 04-06
• X9 01-02 • X9 Evolution 03
180: X9 Amalfi 00-03
200: Beverly 01-03 • X8 04 • X9 02-03
• X9 Evolution 03
(R.O. 82517R)





CAMPANE FRIZIONE CLUTCH BELLS

PIAGGIO

10 026 0170 

400: Beverly Eu3 06-07 • Beverly Tourer Eu3 08-09 • Mp3 07-08 • X Evo 07-09 • X8 Eu3 06-08
500: Beverly 02-06 • Beverly Cruiser 07-09 • X9 01-02 • X9 Evolution 03-07
(R.O. 825176)



10 026 0190 

125: Beverly Rst 06-07 • Carnaby 07-09
150: Liberty 4T Eu3 08 • Vespa Lx 05-06
200: Carnaby 07-08 • Liberty 06 • X8 05-07
250: Beverly 06-07 • Carnaby 08 • Mp3 06-08
300: Beverly le Tourer 09 • Carnaby Cruiser 09
(R.O. 8440494)



10 026 0210 

250: X9 00-01



YAMAHA

10 026 0020 

MOTORI MINARELLI - MINARELLI ENGINE Ø 105
50: Axis 93> • Bw'S 92-96 • Jog 88> • Jog (Italia) 93-96 • Spy <96
(R.O. 72601700)



10 026 0030 

MOTORI MINARELLI - MINARELLI ENGINE Ø 107
50: Aerox 97> • Breeze 97> • Bw'S 97> • Jog All Models 97>
(R.O. 72602700)



10 026 0080 

250: Black X • Max 09 • Majesty 00-03 • Majesty Abs 03 • X-City 07-10 • X-Max 05-10
300: Versity 03-06
(R.O. 5GM166110000)



10 026 0200 

125: X-City 08-10 • X Max 06-10
(R.O. 1B9E66110000)



CAMPANE FRIZIONE VENTILATE - VENTILATED CLUTCH OUTER

10 026 0150 

MOTORI MINARELLI
MINARELLI ENGINE 50 CC Ø 107
MBK-MINARELLI-YAMAHA



10 026 0160 

MOTORI PIAGGIO
PIAGGIO ENGINE 50 CC Ø 107
GILERA - PIAGGIO



CAMPANE FRIZIONE 50 CC
CLUTCH BELLS 50 CC



MODELLO - MODEL	ANNO YEAR	CAMPANA FRIZIONE CLUTCH OUTER
APRILIA		
Amico Tutti I Modelli	90>	10 026 0020
Amico Tutti I Modelli	96>	10 026 0030
Gulliver	95-96	10 026 0020
Gulliver	97>	10 026 0030
Mojito	04-08	10 026 0010
Rally Lc	95-96	10 026 0020
Rally Liquid Cooled	96>	10 026 0030
Scarabeo	94-95	10 026 0020
Scarabeo	96>	10 026 0030
Scarabeo 4T Rst Eu3	06-09	10 026 0010
Scarabeo Quattro	09	10 026 0010
Scarabeo Street 2T Rst	06-09	10 026 0010
Sonic	98>	10 026 0030
Sport City One 2T	08-09	10 026 0010
Sport City One 4T	08	10 026 0010
Sr Netscaper	98>	10 026 0030
Sr Racing	97>	10 026 0030
Sr Stealth	97>	10 026 0030
Sr Tutti I Modelli	93-95	10 026 0020
Sr Tutti I Modelli	96>	10 026 0030
Sr Www	97>	10 026 0030
Sr R R Factory	04-09	10 026 0010
Sr Street	03-08	10 026 0010
Scarabeo 4T Rst 100cc	06-09	10 026 0010
BENELLI		
491 Gt	97>	10 026 0030
491 Sport	97>	10 026 0030
K2 (Ac)	98>	10 026 0030
K2 (Lc)	98>	10 026 0030
BETA		
Ark	96>	10 026 0030
Chrono	93-94	10 026 0020
Chrono	96>	10 026 0030
Quadra	94>	10 026 0020
Tempo	93>	10 026 0020
GARELLI		
Pony	92>	10 026 0020
Sr	92>	10 026 0020
GILERA		
Dna	00-02	10 026 0010
Dna	05-07	10 026 0010
Dna Gp Experience	03-04	10 026 0010
Easy Moving	95-96	10 026 0010
Ice	01-05	10 026 0010
Runner	97-00	10 026 0010

MODELLO - MODEL	ANNO YEAR	CAMPANA FRIZIONE CLUTCH OUTER
Runner Poggiali	02	10 026 0010
Runner Purejet	02-07	10 026 0010
Runner Purejet St	08	10 026 0010
Runner Sp	02-07	10 026 0010
Runner Sp St & Simoncelli	08-09	10 026 0010
Stalker	97-09	10 026 0010
Stalker Naked	08	10 026 0010
Stalker Spec Edit	07-08	10 026 0010
Storm	94-95	10 026 0010
Storm Eu2	07	10 026 0010
Typhoon	94-97	10 026 0010
Typhoon X	98-99	10 026 0010
Typhoon Xr	00	10 026 0010
ITALJET		
Bazooka	91>	10 026 0020
Dragster	97>	10 026 0030
Pista	92>	10 026 0020
Reporter	90>	10 026 0020
Scoop	93>	10 026 0020
Yankee	94>	10 026 0020
LEM		
Flash	94>	10 026 0020
Ghibli	90>	10 026 0020
MALAGUTI		
Centro	92>	10 026 0020
Centro SL	98>	10 026 0030
F 10	97>	10 026 0030
F 10 (All Models)	92-96	10 026 0020
F 12 Phantom	94-96	10 026 0020
F 12 Phantom Ac	97>	10 026 0030
F 12 Phantom Lc	97>	10 026 0030
F 12 Phantom Twin Disk	98>	10 026 0030
F 15 Firefox	96-97	10 026 0020
F 15 Firefox	98>	10 026 0030
F 15 Firefox Twin Disk	97>	10 026 0030
Yesterday	97>	10 026 0030
MBK		
Active	90>	10 026 0020
Booster	<94	10 026 0020
Booster All Models	97>	10 026 0030
Booster Ng	95>	10 026 0020
Booster R	94>	10 026 0020
Booster Spirit	96>	10 026 0020
Booster Track	96>	10 026 0020
Nitro	97>	10 026 0030
Ovetto	97>	10 026 0030



CAMPANE FRIZIONE 50 CC

CLUTCH BELLS 50 CC

MODELLO - MODEL	ANNO YEAR	CAMPANA FRIZIONE CLUTCH OUTER
Rocket	96>	10 026 0020
Sorriso	<96	10 026 0020
Sorriso	97>	10 026 0030
Target	92>	10 026 0020
PIAGGIO		
Diesis	01	10 026 0010
Fly 2T	05-07	10 026 0010
Fly 4T	05-08	10 026 0010
Fly 4T Mot Chn	06-07	10 026 0010
Free	92-94	10 026 0010
Free Delivery	00-01	10 026 0010
Free FL	95-02	10 026 0010
Liberty	97-05	10 026 0010
Liberty 2T	06-08	10 026 0010
Liberty 2T Rst	04	10 026 0010
Liberty 2T Sport	06-08	10 026 0010
Liberty 4T	00-02	10 026 0010
Liberty 4T	05-08	10 026 0010
Liberty 4T Delivery Tnt	09	10 026 0010
Liberty 4T Rst	04	10 026 0010
Liberty 4T Sport	06-08	10 026 0010
Liberty Moc 2T	09	10 026 0010
Liberty Moc 4T	09	10 026 0010
Liberty Ptt Eu2	04-05	10 026 0010
Nrg	94-96	10 026 0010
Nrg Extreme	99-00	10 026 0010
Nrg Mc3	01-04	10 026 0010
Nrg Power Dd	05-09	10 026 0010
Nrg Power Dd Serie Spece	07-08	10 026 0010
Nrg Power Dt	06-08	10 026 0010
Nrg Power Dt Serie Spece	07-08	10 026 0010
Nrg Power Purejet	04-08	10 026 0010
Nrg Purejet	02-04	10 026 0010
Nrg Rst Mc2	96-98	10 026 0010
Ntt	95-96	10 026 0010
Quartz	92-96	10 026 0010
Sfera Maquillage 2	94	10 026 0010
Sfera Rst	95-97	10 026 0010
Typhoon	01-09	10 026 0010
Velofax	96-99	10 026 0010
Vespa Et2	97-05	10 026 0010
Vespa Et2 Iniezione	97-00	10 026 0010
Vespa Et4	00-05	10 026 0010
Vespa Lx 2T	05-08	10 026 0010
Vespa Lx 2T FL	09	10 026 0010
Vespa Lx 4T	05-08	10 026 0010

MODELLO - MODEL	ANNO YEAR	CAMPANA FRIZIONE CLUTCH OUTER
Vespa Lx 4T-4V	09	10 026 0010
Vespa Lxv 2T	06-08	10 026 0010
Vespa Lxv 2T Navy	08	10 026 0010
Vespa S 2T	07-08	10 026 0010
Vespa S 4T-4V	08-09	10 026 0010
Zip	95-96	10 026 0010
Zip	00-04	10 026 0010
Zip 2T	08-09	10 026 0010
Zip 4T	00-08	10 026 0010
Zip Fast Raider	93-94	10 026 0010
Zip Fast Raider Rst	96-97	10 026 0010
Zip Rst	96-99	10 026 0010
Zip Sp	96-04	10 026 0010
Zip Sp Eu2	06-09	10 026 0010
YAMAHA		
Aerox	97>	10 026 0030
Axis	93>	10 026 0020
Beluga	89>	10 026 0020
Breeze	94-96	10 026 0020
Breeze	97>	10 026 0030
Bw'S	92-96	10 026 0020
Bw'S	97>	10 026 0030
Jog	88>	10 026 0020
Jog (Ita)	93-96	10 026 0020
Jog All Models	97>	10 026 0030
Neo'S	97>	10 026 0030
Spy	<96	10 026 0020
Spy	97>	10 026 0030
Target	91>	10 026 0020
Why	98>	10 026 0030
Zest	<96	10 026 0020
Zest	96>	10 026 0030
Zuma	96>	10 026 0020

GIRANTI - CAMPANE - MAXISCOOTER

CLUTCHES - OUTERS - MAXISCOOTER



MODELLO - MODEL	CC	ANNO YEAR	CAMPANA OUTER	GIRANTE CLUTCH	MODELLO - MODEL	CC	ANNO YEAR	CAMPANA OUTER	GIRANTE CLUTCH
APRILIA					ADIVA				
Scarabeo 4t Rst	100	06-09	10 026 0010		Adiva	125	01-02		10 036 0020
Atlantic Eu3	125	06-12	10 026 0190	10 036 0380	BENELLI				
Leonardo	125	96-98	10 026 0180		Velvet	125	99-01		10 036 0060
Leonardo	125	99-01	10 026 0180	10 036 0130	Velvet Touring	125	02-03		10 036 0060
Leonardo St	125	01-04	10 026 0180	10 036 0130	DERBI				
Mojito	125	03-08	10 026 0190	10 036 0380	Rambla	250	08		10 036 0410
Mojito	125	08		10 036 0380	GILERA				
Mojito Retro' - Custom	125	99-01	10 026 0040	10 036 0010	Dna	125	01	10 026 0050	10 036 0020
Scarabeo	125	04-06	10 026 0050		Nexus Eu3	125	07-08	10 026 0190	10 036 0380
Scarabeo Eu3	125	06-07	10 026 0050		Nexus Eu3 Ie	125	08-09		10 036 0380
Scarabeo Light	125	07-08		10 036 0380	Runner Fx-Fxr	125	97-02		10 036 0030
Scarabeo Mot Rotax	125	99-03	10 026 0180	10 036 0130	Runner Vx	125	05-06	10 026 0190	10 036 0380
Sport City	125	04-06	10 026 0190	10 036 0380	Runner Vx 4t Eu3	125	07	10 026 0190	10 036 0380
Sport City Cube	125	08-10	10 026 0190	10 036 0380	Runner Vx 4t St Eu3	125	08-09		10 036 0380
Sport City Eu3	125	06-08	10 026 0190	10 036 0380	Runner Vx Race	125	06		10 036 0380
Sport City One 4T	125	08-09	10 026 0190	10 036 0380	Runner Vx Sc	125	06-07	10 026 0190	10 036 0380
Sr	125	99-01		10 036 0030	Runner Vx Vxr	125	00-01	10 026 0050	10 036 0020
Sr Max	125	11	10 026 0190		Runner Vx-Vxr	125	02-04	10 026 0050	10 036 0380
Leonardo	150	96-01		10 036 0140	Typhoon	125	95-98		10 036 0030
Leonardo St	150	01-04	10 026 0180	10 036 0140	Typhoon X-Xr	125	99-00		10 036 0030
Mojito	150	03-07	10 026 0190		Dna	180	01	10 026 0050	10 036 0050
Scarabeo Mot Rotax	150	99-03	10 026 0180	10 036 0140	Runner Fx-Fxr	180	97-02		10 036 0040
Atlantic	200	03-05		10 036 0330	Runner Vx-Vxr	180	00-01	10 026 0050	10 036 0050
Scarabeo	200	03		10 036 0330	Runner Vx-Vxr	180	02-04	10 026 0050	
Scarabeo Eu3	200	06-07	10 026 0050	10 036 0330	Runner Vxr	200	05-06	10 026 0190	10 036 0330
Scarabeo Mot Rotax	200	99-03	10 026 0180		Runner Vxr 4t St Eu3	200	08		10 036 0330
Sport City	200	04-06	10 026 0190	10 036 0330	Runner Vxr Eu3	200	07	10 026 0190	10 036 0330
Sport City Cube	200	08	10 026 0190	10 036 0330	Runner Vxr Race	200	06		10 036 0330
Sport City Eu3	200	06-08	10 026 0190	10 036 0330	Nexus Eu3	250	06	10 026 0190	10 036 0410
Atlantic	250	03-05	10 026 0050	10 036 0410	Nexus Sp Eu3	250	06-07	10 026 0190	
Atlantic Eu3	250	06-08	10 026 0190	10 036 0410	Oregon	250	06-08	10 026 0190	
Scarabeo	250	04-06	10 026 0050	10 036 0410	Nexus Eu3	300	09	10 026 0190	
Scarabeo Light	250	06-08	10 026 0190	10 036 0410	Fuoco	500	07-09	10 026 0170	
Sport City Eu3	250	06-08	10 026 0190	10 036 0410	Nexus	500	03-05	10 026 0170	10 036 0420
Sport City Cube	250	06-08	10 026 0190	10 036 0410	Nexus Eu3	500	06-09	10 026 0170	10 036 0310
Scarabeo Light	300	09	10 026 0190	10 036 0410	Nexus Sp Eu3	500	06-07	10 026 0170	
Sport City Cube	300	08	10 026 0190	10 036 0410	HONDA				
Sr Max	300	11	10 026 0190		Chiocciola	125	00-06	10 026 0110	10 036 0160
Atlantic Sprint	400	05-08	10 026 0170		Dylan	125	01-06	10 026 0110	10 036 0160
Scarabeo Light	400	06-08	10 026 0170	10 036 0420	Nes	125	00-07	10 026 0110	10 036 0160
Atlantic	500	01-04		10 036 0320	Pantheon 2t	125	98-02	10 026 0110	
Atlantic Sprint	500	05-08	10 026 0170	10 036 0310	Sh 125	125	01-08	10 026 0110	10 036 0160
Scarabeo Light	500	06-08	10 026 0170	10 036 0310	Sh 125i	125	01-08	10 026 0110	10 036 0160



GIRANTI - CAMPANE - MAXISCOOTER

CLUTCHES - OUTERS - MAXISCOOTER

MODELLO - MODEL	CC	ANNO YEAR	CAMPANA OUTER	GIRANTE CLUTCH	MODELLO - MODEL	CC	ANNO YEAR	CAMPANA OUTER	GIRANTE CLUTCH
Chiocciola	150	00-06	10 026 0110	10 036 0160	Movie XI	150	01	10 026 0110	10 036 0160
Dylan	150	01-06	10 026 0110	10 036 0160	Movie XI Eu2	150	03-04	10 026 0110	10 036 0160
Nes	150	00-07	10 026 0110	10 036 0160	People	150	99-00	10 026 0110	10 036 0160
Pantheon 2t	150	98-02	10 026 0110		People 0 Eu2	150	03	10 026 0110	10 036 0160
Sh 150	150	01-08	10 026 0110	10 036 0160	Vivio	150	00		10 036 0160
Sh 150i	150	01-08	10 026 0110	10 036 0160	People S 200i	200	07	10 026 0110	
Foresight	250	98	10 026 0210	10 036 0100	B&W	250	00		10 036 0360
Jazz	250	00-04	10 026 0210		B&W Eu2	250	03		10 036 0360
Sh	300	07-13	10 026 0210	10 036 0100	Grand Dink	250	01-02		10 036 0360
ITALJET					Grand Dink Eu2	250	03-04		10 036 0360
Jet Set 4t	125			10 036 0020	People Lc	250	03-04		10 036 0360
Torpedo	125	98-00		10 036 0010	People S	250	06		10 036 0360
Torpedo (Mot Leader)	125	00-03		10 036 0020	People S 250i	250	07		10 036 0360
Dragster	180	99-03		10 036 0040	X Citing	250	05		10 036 0360
KYMCO					X Citing I	250	06-07		10 036 0360
Agility 4t	125	06	10 026 0110	10 036 0160	Yup	250	03		10 036 0360
Agility 4t Eu3	125	06-08	10 026 0110		People S 300i	300	08		10 036 0360
Agility Rs	125	09		10 036 0160	X Citing 300i	300	08		10 036 0360
B&W	125	00		10 036 0170	X Citing 300i R	300	08-09		10 036 0360
B&W Eu2	125	03-04		10 036 0530	MALAGUTI				
Dink	125	97-98		10 036 0170	Ciak	125	00-01	10 026 0110	10 036 0160
Dink Classic	125	02		10 036 0170	Ciak Master	125	04	10 026 0110	10 036 0160
Dink Classic Eu2	125	03		10 036 0170	Ciak Rst Eu2	125	03	10 026 0110	10 036 0160
Dink Lx	125	98-00		10 036 0170	Madison	125	99-01		10 036 0060
Downtown I	125	09		10 036 0530	Madison R Rst	125	02		10 036 0060
Grand Dink	125	01-02		10 036 0170	Ciak	150	00-02	10 026 0110	10 036 0160
Grand Dink Eu2	125	03-04		10 036 0170	Ciak Master	150	04	10 026 0110	10 036 0160
Heroism	125	95-97	10 026 0110	10 036 0160	Ciak Rst Eu2	150	03	10 026 0110	10 036 0160
K-Xct I	125	12		10 036 0530	Madison T	150	99-01		10 036 0090
Movie	125	99-00	10 026 0110	10 036 0160	MBK				
Movie 125 Eu3	125	06-07	10 026 0110	10 036 0160	Skyliner	125	98-02		10 036 0060
Movie XI	125	01	10 026 0110	10 036 0160	Thunder	125	01-02		10 036 0060
Movie XI Eu2	125	03-04	10 026 0110	10 036 0160	Doodo	150	01-02		10 036 0090
People	125	99-00	10 026 0110	10 036 0160	Skyliner	150	00-02		10 036 0090
People Eu2	125	03	10 026 0110	10 036 0160	Thunder	150	01-02		10 036 0090
People Eu3	125	07-08	10 026 0110	10 036 0160	Skyliner	250	00-03	10 026 0080	10 036 0070
People Gti	125	10		10 036 0530	Skyliner Abs	250	03	10 026 0080	10 036 0070
Vivio	125	00	10 026 0110	10 036 0160	Kilibre	300	03	10 026 0080	10 036 0070
B&W	150	00		10 036 0170	PEUGEOT				
B&W Eu2	150	03-04		10 036 0530	Elyseo	100	99-01		10 036 0300
Dink	150	97-98		10 036 0170	Speedfight	100	97-00		10 036 0300
Dink Classic	150	02		10 036 0170	Vivacity	100	99-01		10 036 0300
Dink Classic Eu2	150	03		10 036 0170	X-Fight	100	00-01		10 036 0300
Dink Lx	150	98-00		10 036 0170	Sv	250	01-02	10 026 0210	10 036 0100
Heroism	150	95-97	10 026 0110						
Movie 150 Eu3	150	06-07	10 026 0110	10 036 0160					

GIRANTI - CAMPANE - MAXISCOOTER

CLUTCHES - OUTERS - MAXISCOOTER



MODELLO - MODEL	CC	ANNO YEAR	CAMPANA OUTER	GIRANTE CLUTCH	MODELLO - MODEL	CC	ANNO YEAR	CAMPANA OUTER	GIRANTE CLUTCH
PIAGGIO					Vespa Lx	125	05-06	10 026 0190	10 036 0520
Fly 4t	100	06-08	10 026 0010		Vespa Lx 4t FL	125	09	10 026 0190	10 036 0520
Free	100	02-03	10 026 0010		Vespa Lx Eu3	125	06-08	10 026 0190	10 036 0520
Zip 4t	100	06-08	10 026 0010		Vespa Lx Eu3 le	125	09	10 026 0190	
Beverly	125	01-03	10 026 0050	10 036 0020	Vespa Lx 4T Eu3 Touring	125	10-11		10 036 0520
Beverly Eu3	125	07-08		10 036 0380	Vespa Lx 4T 3V le Touring	125	12-13		10 036 0510
Beverly Eu3 Mic	125	07	10 026 0190	10 036 0380	Vespa 946 4T 3V Abs	125	13		10 036 0510
Beverly Eu3 Sport	125	07-08	10 026 0190	10 036 0380	Vespa Lxv 4t Eu3	125	06-09	10 026 0190	10 036 0520
Beverly Rst	125	06-07	10 026 0190	10 036 0380	Vespa Lx V le 4T	125	10-12		10 036 0520
Beverly Rst	125	04-05		10 036 0380	Vespa Lxv 4t Navy Eu3	125	08	10 026 0190	10 036 0520
Beverly Tourer Eu3	125	08-09		10 036 0380	Vespa Px T5	125	85-89	10 026 0140	
Carnaby	125	07-09	10 026 0190	10 036 0380	Vespa S 4t Eu3	125	07-08	10 026 0190	10 036 0520
Cosa Cl-Clx	125	88-91	10 026 0140		Vespa S 4t le	125	09-11	10 026 0010	10 036 0520
Fly	125	05-07	10 026 0190		X Evo	125	07	10 026 0190	10 036 0380
Fly Eu3	125	05-07	10 026 0190	10 036 0520	X7 Eu3	125	08	10 026 0190	10 036 0380
Fly 4T 3V le Eu3	125	12		10 036 0510	X7 Evo le Eu3	125	09	10 026 0190	10 036 0380
Hexagon	125	94-97		10 036 0030	X8	125	04	10 026 0050	10 036 0020
Hexagon Gtx	125	00		10 036 0380	X8	125	05-06	10 026 0190	10 036 0380
Hexagon Lx-Lxt	125	98-99		10 036 0030	X8 Premium Eu2	125	06	10 026 0190	10 036 0380
Hexagon Lx4	125	98-99	10 026 0040	10 036 0010	X8 Premium Eu3	125	06-07	10 026 0190	10 036 0380
Liberty	125	98-00	10 026 0040	10 036 0010	X8 Street Eu2	125	06-07	10 026 0190	10 036 0520
Liberty	125	01-02		10 036 0380	X9	125	01-02	10 026 0050	10 036 0380
Liberty 4t	125	06-07	10 026 0190	10 036 0520	X9 Evolution	125	03	10 026 0050	10 036 0020
Liberty 4t Eu3	125	07-08	10 026 0190	10 036 0520	X9 Evolution	125	05-06	10 026 0190	10 036 0380
Liberty 4t Sport Eu3	125	06-08	10 026 0190	10 036 0520	X9 Evolution Eu3	125	07	10 026 0190	10 036 0380
Liberty Moc 4t	125	09	10 026 0190		Zip	125	00-02		10 036 0380
Liberty Rst	125	04-05		10 036 0380	Cosa Cl-Clx	150	88-91	10 026 0140	
Liberty Rst Ptt	125	05-06		10 036 0380	Fly	150	05-07	10 026 0190	10 036 0520
Liberty Sport	125	06-08	10 026 0190	10 036 0520	Fly Eu3	150	08-11		10 036 0520
Mp3	125	07-08	10 026 0190	10 036 0380	Hexagon	150	94-97		10 036 0030
Mp3 Ibrido	125	09		10 036 0380	Liberty 4t Eu3	150	08	10 026 0190	10 036 0520
Mp3 le	125	08-09		10 036 0380	Liberty 4t Sport Eu3	150	08	10 026 0190	10 036 0520
Sfera	125	95-97	10 026 0040	10 036 0010	Liberty Moc 4t	150	09-13	10 026 0190	10 036 0520
Skipper	125	94-97		10 036 0030	Skipper	150	94-97		10 036 0030
Skipper 4t	125	00-02		10 036 0380	Vespa Lx	150	05-06	10 026 0190	10 036 0520
Skipper Lx	125	98-99		10 036 0030	Vespa Lx Eu3	150	06-08	10 026 0190	10 036 0520
Super Hexagon Gtx 12"	125	01-02		10 036 0380	Vespa Lx Eu3 le	150	09	10 026 0190	10 036 0520
Typhoon 4T 2V Eu3	125	10-11		10 036 0520	Vespa Lx Touring	150	10-12		10 036 0520
Vespa Et4	125	96-98	10 026 0040	10 036 0010	Vespa Lx 4T 3V le Touring	150	12-13		10 036 0510
Vespa Et4	125	99-02	10 026 0190	10 036 0380	Vespa S 4t le	150	09	10 026 0190	10 036 0520
Vespa Granturismo	125	06-07	10 026 0190	10 036 0380	X8 Street Eu2	150	06-08	10 026 0190	10 036 0520
Vespa Granturismo Eu3	125	06-07	10 026 0190	10 036 0380	Hexagon Gtx	180	00		10 036 0050
Vespa Gts 4t le Super	125	09	10 026 0190	10 036 0380	Hexagon Lx-Lxt	180	98-99		10 036 0040
Vespa Gts Eu3	125	07-09	10 026 0190	10 036 0380	Super Hexagon Gtx 12"	180	01-02		10 036 0050
Vespa Gtv	125	07-08	10 026 0190	10 036 0380	X9 Amalfi	180	00-03	10 026 0050	
Vespa Gtv 4t Navy Eu3	125	08	10 026 0190	10 036 0380	Beverly	200	01-03	10 026 0050	10 036 0330



GIRANTI - CAMPANE - MAXISCOOTER

CLUTCHES - OUTERS - MAXISCOOTER

MODELLO - MODEL	CC	ANNO YEAR	CAMPANA OUTER	GIRANTE CLUTCH
Carnaby	200	07-08	10 026 0190	10 036 0330
Cosa Cl-Clx	200	88-91	10 026 0140	
Liberty	200	06	10 026 0190	10 036 0050
Liberty 4t Eu3	200	07-08	10 026 0190	10 036 0050
Liberty 4t Sport Eu3	200	06-07	10 026 0190	10 036 0050
Liberty Rst	200	04		10 036 0050
Liberty Sport	200	06	10 026 0190	10 036 0050
Vespa Granturismo	200	03-07		10 036 0330
Vespa Pxe Arcobaleno	200	81-97	10 026 0140	
X8	200	05-07	10 026 0190	10 036 0330
X8 125-200	200	04	10 026 0050	
X9	200	02-03	10 026 0050	
X9 Evolution	200	03	10 026 0050	
Beverly	250	06-07	10 026 0190	10 036 0410
Beverly Cruiser	250	07-09	10 026 0190	10 036 0410
Beverly Eu3 Mic	250	07	10 026 0190	10 036 0410
Beverly Ie Eu3	250	06-08	10 026 0190	10 036 0410
Beverly Rst	250	04-05	10 026 0190	10 036 0410
Beverly Sport	250	06-08	10 026 0190	10 036 0410
Beverly Tourer Eu3	250	08-09	10 026 0190	10 036 0410
Carnaby	250	08	10 026 0190	10 036 0410
Mp3	250	06-08	10 026 0190	10 036 0410
Mp3 Lt	250	09	10 026 0190	10 036 0410
Mp3 Mic	250	08-09	10 026 0190	10 036 0410
Vespa Gt 60 Eu3	250	06-07	10 026 0190	10 036 0410
Vespa Gts, Gts Abs	250	05-09	10 026 0190	10 036 0410
Vespa Gtv	250	06-09	10 026 0190	10 036 0410
Vespa Gtv 4t Navy Eu3	250	08	10 026 0190	10 036 0410
X7 Eu3	250	08	10 026 0190	10 036 0410
X8 Eu3	250	05-08	10 026 0190	10 036 0410
X9	250	00-01	10 026 0210	10 036 0100
X9 Evolution	250	06	10 026 0190	10 036 0410
Xevo	250	07	10 026 0190	10 036 0410
Beverly 300 Ie Tourer	300	09	10 026 0190	10 036 0410
Carnaby Cruiser	300	09	10 026 0190	10 036 0410
Vespa Gts Super	300	08	10 026 0190	10 036 0410
X7 Evo Ie Eu3	300	09	10 026 0190	10 036 0410
Beverly Eu3	400	06-07	10 026 0170	10 036 0420
Beverly Tourer Eu3	400	08-09	10 026 0170	10 036 0420
Mp3	400	07-08	10 026 0170	10 036 0420
Mp3 Lt	400	09	10 026 0170	
Mp3 Mic	400	08-09	10 026 0170	
X Evo	400	07-09	10 026 0170	10 036 0420
X8 Eu3	400	06-08	10 026 0170	10 036 0420
Beverly	500	02-06	10 026 0170	10 036 0310

MODELLO - MODEL	CC	ANNO YEAR	CAMPANA OUTER	GIRANTE CLUTCH
Beverly Cruiser	500	07-09	10 026 0170	10 036 0310
Beverly Eu3	500	06-08	10 026 0170	10 036 0310
X9	500	01-02	10 026 0170	10 036 0320
X9 Evolution	500	03-07	10 026 0170	10 036 0310
X9 Evolution Abs	500	06-07	10 026 0170	10 036 0310
SUZUKI				
Burgman	125	02-06		10 036 0370
Burgman	125	07-10		10 036 0430
Sixteen	150	08-11		10 036 0440
Burgman	200	07-10		10 036 0450
Burgman	250	98-02		10 036 0120
Burgman	400	99-06		10 036 0110
Burgman	400	07-10		10 036 0460
SYM				
Joyride Eu2	125	05-06		10 036 0160
Joyride Eu3	125	07		10 036 0160
Joyride Evo	125	09		10 036 0160
Track Runner	180	06-07		10 036 0160
YAMAHA				
Majesty	125	98-02		10 036 0060
Maxster	125	01-02		10 036 0060
X-City	125	08	10 026 0200	10 036 0390
X-Max	125	06-09	10 026 0200	10 036 0390
Majesty	150	01-02		10 036 0090
Maxster	150	01-02		10 036 0090
Teos	150	01-02		10 036 0090
Black X-Max	250	09	10 026 0080	10 036 0070
Majesty	250	00-03	10 026 0080	
Majesty Abs	250	03	10 026 0080	
X-City	250	07-10	10 026 0080	10 036 0070
X-Max	250	05	10 026 0080	
X-Max	250	06-10	10 026 0080	10 036 0070
Versity	300	03-06	10 026 0080	10 036 0070
Majesty	400	04-06		10 036 0350
Majesty	400	07-08		10 036 0400
Majesty Abs	400	07-08		10 036 0400



APRILIA

10 032 0130 

50: Mojito Custom 2T Motore Piaggio 04-10
• Scarabeo 2T Eu2 Motore Piaggio 10-12
• Scarabeo 2T Net 09-10 • Scarabeo 2T 14
• Scarabeo 4T 4V Net 09-10 • Scarabeo 4T 4V 10-14
• Scarabeo 4T Restyling Eu3 06-09 • Scarabeo 4T 02-06
• Scarabeo Quattro 09 • Scarabeo Street 2T Restyling 06-09
• Scarabeo Street 05-06 • Sport City one 2T 08-11
• Sport City One 4T 08-10 • Sr iniezione e carburatore 14
• Sr motard 2T 12-14 • Sr Motard 4T 4V 13-14
• Sr R Factory ie e carburatore 10-14
• Sr R R Factory 04-09 • Sr Street 03-12
100: Scarabeo 4T Net Eu3 10 • Scarabeo 4T Net 09
• Scarabeo 4T Restyling 06-09 • Scarabeo 4T 01-14
(R.O. 479561)



10 032 0150 

125: Atlantic Eu3 06-12 • Atlantic 03-05 • Mojito 03-08
• Scarabeo Motore Piaggio Eu3 06 • Scarabeo 03-06
• Sport City Cube 08-10 • Sport City Eu3 06-08
• Sport City One 4T Eu3 08-11
• Sport City Street 12 • Sport City 04-06 • Sr Motard 12-14
(R.O. AP8580085)



10 032 0160 

125: Scarabeo Light 07-09 (R.O.827586)
200: Atlantic 03-05 • Scarabeo 03 • Scarabeo Eu3 06-07
• Sport City 04-06 Sport City Eu3 06-08
• Sport City Cube 08-10 (R.O. AP8575027)



10 032 0240 

400: Atlantic Sprint 05-08 • Scarabeo Light 06-08
500: Atlantic Sprint 05-08
Scarabeo 03-06 • Scarabeo Light 06-08
(R.O. 832697)



10 032 0270 

250: Atlantic Eu3 06-08 • Atlantic 03-05 • Scarabeo 04-06
• Sport City Eu3 06-08
250: Scarabeo Light 06-08 • Sport City Cube 08-12
300: Atlantic 10-11 • Scarabeo Light 09-10 • Sport City Street 12
• Sr Max 11-14 (R.O. 840193)



10 032 0310 

125: Atlantic 03-05 • Scarabeo Motore Piaggio Eu3 06
• Scarabeo 03 • Sport City Eu3 06-08 • Sport City 04-06
(R.O. AP8575027)



DERBI

10 032 0320 

500: Atlantic 01-04
(R.O. AP8560172)



10 032 0130 

50: Atlantis 2T Eu2 07-09 • Atlantis 2T 10 • Atlantis 4T Eu2 07
• Atlantis 4T 04-06 • Atlantis 02 Bullet 03-05 • Atlantis 02 City 03-06
• Atlantis 02 Red Bullet 03 • Atlantis 02 Two Chic 05 • Atlantis 02 02
• Boulevard 2T 09-14 • Boulevard 4T Eu2 25 Km/h 09
• Gp1 E2 03 • Gp1 Eu2 05 • Gp1 open Eu2 06-09
• Gp1 Race Eu2 05-07 • Gp1 01-03 • Sonar 2T 09
• Variant Sport 2T 12
100: Boulevard 4T 10-11 (R.O. 479561)



10 032 0150 

125: Boulevard Eu2 04-07 • Boulevard 02-04 • Boulevard 4T Eu3 08-12
• Gp1 Eu2 06 • Gp1 Low Seat Eu3 07-08
• Rambla E3 2Ver 08 • Rambla 08-09 • Sonar 4T 09-11
• Variant Sport 4T E3 12
150: Boulevard 4T E3 10 • Sonar 4T 09
(R.O. 845607)



10 032 0270 

125: Rambla E3 2Ver 08 • Rambla 08-09
250: Gp1 Low Seat Eu3 07-08 • Gp1 06-07
300: Rambla 10-11 (R.O. 840193)



10 032 0310 

125: Boulevard Eu2 04-07 • Boulevard 4T Eu3 08-12
• Gp1 Eu2 06 • Gp1 Low Seat Eu3 07-08 • Rambla E3 2Ver 08
• Rambla 08-09 • Sonar 4T 09-11
• Variant Sport 4T E3 12
150: Boulevard 4T E3 10 • Sonar 4T 09
(R.O. 845607)





SEMIPULEGGE MOTRICI FISSE
FIXED DRIVE HALF PULLEY

GILERA

10 032 0120 

50: Easy Moving 95-96 • Storm 94-95
• Typhoon 94-97
(R.O. 289831)



10 032 0130 

50: Dna Gp Experience 03-04 • Dna 00-07
• Ice 01-05 • Runner Poggiali 02 • Runner
Purejet St 08 • Runner Purejet 02-11 • Runner
Sp Special Edition 07 • Runner Sp St & Simon-
celli 08-09 • Runner Sp 02-12 • Runner 97-00 •
Stalker Naked 08 • Stalker Special Edition 07-08
• Stalker 97-11 • Storm Eu2 07 • Typhoon Xr 00
(R.O. 479561)



10 032 0150 

125: Dna 01 • Runner Vx Vxr 00-01
(R.O. 485118 • 485118)



10 032 0160 

180: Dna 01 • Runner Vx-Vxr 00-04
200: Runner Vxr 05-06 • Runner Vxr Eu3 07
• Runner Vxr Race 05-06 • Runner Vxr 4T St
Eu3 08-11
(R.O. 834774)



10 032 0200 

125: Runner Fx-Fxr 97-02 • Typhoon X-Xr 99-00
180: Runner Fx-Fxr 97-02
(R.O. 487957)



10 032 0240 

500: Fuoco 4T 4V ie Eu3 Lt 13-14 • Fuoco Eu3
07-13 • Nexus Eu3 06-11 • Nexus Sp Eu3 06-07
• Nexus 03-05
(R.O. 832697)



10 032 0270 

250: Nexus Eu3 06-07 • Oregon 06-10
300: Nexus Eu3 08-11
(R.O. 840193)



10 032 0310 

125: Nexus Eu3 07-08 • Runner Vx 05-06
• Runner Vx 4t Eu3 06-13 • Runner Vx Race 06
(R.O. 845607)



HONDA

10 032 0440 

125: Pantheon Fes 03-05 • Silver Wing Fes 07-
12 • Pes Injection 06-10 • Sh 01-12
150: Sh 01-12
(R.O. 22102-KGF-910)



10 032 0660 

125: Sh Mode 14-15 • Pcx 10-12
150: Pcx 10-14
(R.O. 22102-KZR-600 • 22102-KWN-900)



10 032 0640 

125: Sh Abs 13-16
150: Sh 13-16
(R.O. 2210-K01-900)





HONDA

10 032 0650

300: Sh 07-16 • Forza Abs 14-16
(R.O. 22102-KTW-900)



KYMCO

10 032 0410

125: Agility 4T Eu3 06-08 • Agility 4T 06 • Agility Carry 11 • Agility R16 08-12 • Agility Rs 09 • Like Lx 12 • Like 09 • Movie Eu3 06-07 • Movie XL Eu2 03-04 • Movie XL 01 • Movie 99-00 • People Eu2 03 • People 99-00 • People Eu3 07-11 • People One I 13 • People S Dd Eu3 0708 • People S 05 • Super 8 08 • Super 8 09 • Vivio 00 • **150:** Vivio 00 • Agility R16 08-09 • Movie Eu3 06-07 • **200:** Agility R16 10 • Agility i Plus 14 • Agility R16 12 • Like 09 • Like Lx 12 • People S 07 • People S 05
(R.O. 00126115)



10 032 0500

250: B&w Eu2 03 • B&w 00 • Grand Dink Eu2 03-04 • Grand Dink 01-02 • Kxr 03-04 • Mxu 05 • People Lc 03-04 • People S I 07 • People S 06 • X Citing I 06-07 • X Citing 05 • Yup 03
300: G-Dink 12 • Maxxer 05-06 • Mixu R 10 • Mxu 05-06 • People S i 08 • X Citing i R 08-09 • X Citing i 08
(R.O. 00127994)



MBK

10 032 0210

50: Mach G Eu1-Eu2 02-03 • Booster 01-02 • Booster Naked 03 • Booster Spirit 96-00 • Booster Ng 95-03 • Stunt 00-02 • Evolis 92-95 • Flipper 01-02 • Flipper Cat 99-00 • Fizz 94-95 • Ovetto Eu1-Eu2 02-04
(R.O. 3VLE76110000)



PEUGEOT

10 032 0300

50: Buxy 94-97 • Elyseo 99 • Looxor 01-03 • Speedake 95-97 • Speedfight Lc/Ac 97-98 • Vivacity 99 • Zenith L 94-96
100: Elyseo 99-01 • Looxor 01 • Speedfight 97-00 • Sv L 98 • Vivacity 99-01
(R.O. 732801)



PIAGGIO

10 032 0120

50: Free 92-94 • Nrg 94-96 • Ntt 95-96 • Quartz 92-96 • Sfera Rst 95-97 • Vespa Et2 97-05 • Zip 95-96 • Zip Bimodale 94-97 • Zip Fast Raider 93-97 • Zip Rst 96-99
(R.O. 289831)



10 032 0130

50: Fly 2T-4T 05-08 • Fly 4T 2V 12-15 • Fly 4T 4V 12-13 • Free FL 95-02 • Liberty 97-05 • Liberty 2T-4T 06-08 • Liberty Ptt Eu2 04-05 • Liberty 4T Ptt Double 09-15 • Liberty 4T Sport 06-08 • Liberty Iget 4T 3V ie 15-16 • Nrg Purejet 02-10 • Typhoon 01-09 • Vespa Et2 Iniezione 97-00 • Vespa Et4 00-05 • Vespa Lx 2T 05-08 • Vespa Lx 4T 4V 09-13 • Vespa Lxv 2T 06-09 • Vespa Primavera 2T 13-15 • Vespa Primavera 4T 4V 13-16 • Vespa Sprint 4T 4V 14-16 • Zip 00-04 • Zip Sp Eu2 06-13 • Zip 2T 08-13
100: Fly 4T 06-08 • Free 02-03 • Zip 4T 06-10
(R.O. 479561)



10 032 0140

125: Hexagon Lx4 98-99 • Liberty 98-00-Sfera 95-97 • Vespa Et4 96-98
(R.O. 82523R)





SEMIPULEGGE MOTRICI FISSE
FIXED DRIVE HALF PULLEY

PIAGGIO

10 032 0160 

180: Hexagon Gtx 00 • Super Hexagon Gtx 12" 01-02 • X9 Amalfi 00-03
200: Beverly 01-03 • Carnaby 07-08 • Liberty 06 • Liberty 4t Eu3 07-08 • Vespa Granturismo 03-07 • X8 05-07 • X9 02-03
(R.O. 834774)



10 032 0150 

125: Beverly Rst 04-05 • Beverly 01-03 • X8 04 • X9 Evolution 03
(R.O. 485118)



10 032 0200 

125: Hexagon Lx • Lxt 98-99
150: Skipper Lx 98-99
180: Hexagon Lx • Lxt 98-99
(R.O. 487957)



10 032 0240 

400: Beverly Eu3 06-07 • Beverly Tourer Eu3 08-10 • Mp3 ie Lt Touring 11 • Mp3 Mic 08-10 • Mp3 RL Touring 11 • Mp3 07-08 • X8 Eu3 06-08 • X Evo 07-11
500: Beverly 02-06 • Beverly Cruiser 07-12 • Beverly Eu3 06-08 • Mp3 Lt Sport 11-13 • Mp3 RL Sport 11-12 • Mp3 Lt Business Abs 14-16 • X9 Evolution 03-07 • X9 Evolution Abs 06-07 • X10 4T 4V ie Eu3 12-14
(R.O. 832697)



10 032 0270 

250: Beverly 06-07 • Beverly Cruiser 07-09 • Carnaby 08 • Mp3 06-08 • Mp3 Lt 08-09 • Vespa Gts/Gts Abs 05-09 • Vespa Gt 60 Eu3 06-07 • Vespa Gtv 07-09 • X7/X8 Eu3 05-08 • X9 Evolution 04-06
300: Beverly ie Tourer 09-10 • Beverly Rst 4T 4V 10-15 • Beverly ie Abs Eu4 16 • Mp3 ie Lt 10-11 • Mp3 ie Lt Sport 11-14 • Mp3 Yourban ERL 11-15 • Carnaby Cruiser 09 • Vespa Gts Super 08-15 • Vespa Gtv 4T 4V 10-13 • Vespa Gts ie 11-16 • X7 Evo ie Eu3 09
(R.O. 840193)



10 032 0310 

125: Beverly Tourer Eu3 07-10 • Beverly Rst 04-07 • Beverly Eu3 Mic 07 • Carnaby 07-10 • Fly 05-07 • Fly Eu3 07-11 • Hexagon Gtx 00 • Liberty 01-02 • Liberty 4T 06-07 • Liberty Rst Ptt 05-11 • Liberty Sport 06 • Liberty 4T Eu3 Delivery 07-15 • Mp3 06-08 • Super Hexagon Gtx 12" 01-02 • Vespa Et4 99-02 • Vespa Lx 05-06 • Vespa Granturismo 03-07 • Vespa Gtv 06-08 • Vespa Lx Eu3 09-11 • Vespa Lx ie 4T 10-13 • X7 Eu3 08 • X8 05-06 • X8 Premium Eu2 06-07 • X9 Evolution 03-06 • Zip 00-02
150: Fly 05-07 • Fly Eu3 08-11 • Liberty 01-02 • Liberty 4T Eu3 08 • Liberty Moc 4T 09-13 • Vespa Et4 99-02 • Vespa Lx 05-06 • Vespa Lx 4T FL 09 • Vespa Lx Eu3 06-11 • Vespa S 4T ie 08-12 • X8 Street Eu2 06-08
(R.O. 845607)



10 032 0320 

500: X9 01-02
(R.O. 830524)



10 032 0210 

50: Aerox 97-02 • Breeze 94-95 • Bw's Bump 97-98 • Bw's Naked 03 • Bw's Ng 97-06 • Bw's Original 97-02 • Jog R 02-05 • Neo's 02-06 • Why Eu1 99-00 • Why Eu2 03-05 • Why 98-06
(R.O. 3VLE76110000)



YAMAHA



APRILIA

10 032 0020 

50: Scarabeo 4T Rst Eu3 06-09
Scarabeo Quattro 09 • Sr R R Factory 04-09 • Sr
Street 03-08 • Scarabeo 4T 02-06 • Scarabeo
4T 4V 09-14 • Sr Iniezione e carburatore 14 • Sr
Motard 4T 4V 13-14
(R.O. CM110304)



10 032 0030 

50: Mojito 04-10 • Sport City One 4T 08-10
• Sr R R Factory Modello Carburatore 04-09
• Sr Street Modello Carburatore 03-12
(R.O. AP8515112)



10 032 0040 

50: Scarabeo Street 05-06 • Scarabeo Street 2T
Rst 06-09 • Sport City One 2T 08-09
(R.O. CM110302)



10 032 0050 

125: Mojito Retro' • Custom 99-01
(R.O. AP8550509)



10 032 0060 

125: Atlantic 03-05 • Scarabeo 03-06 • Scarabeo
Eu3 06-07 • Atlantic Eu3 06-12 • Scarabeo Light
07-08 • Scarabeo ie Light 09-12 • Sport City
Eu3 06-08 • Sport City 04-06 • Sport City Cube
08-10 • Sport City Street 12 • Sr Max 11-14
(R.O. AP8580222-CM144403)



10 032 0170 

200: Sport City Eu3 06-08 • Sport City 04-06
• Sport City Cube 08-10 • Atlantic 03-05 •
Scarabeo 03-07
(R.O. CM144404)



10 032 0190 

125: Mojito 03-08 • Scarabeo Light 07-08
• Sport City One 08-11 • Sr Motard 12-14
(R.O. CM144402)



10 032 0230 

500: Atlantic 01-09 • Atlantic Sprint 05-08 •
Scarabeo Light 06-08 • Atlantic 01-04
(R.O. AP8560180)



10 032 0260 

250: Sport City 06-08 • Sport City Cube 08-12
• Atlantic 03-05
(R.O. CM144407)



10 032 0330 

400: Atlantic Sprint 05-08
(R.O. 849913)



10 032 0340 

250: Atlantic Eu3 06-08 • Scarabeo Light 06-08
• Sport City Cube 08-12
300: Atlantic 10-11 • Scarabeo Light 09-10 •
Sport City Street 12 • Sr Max 11-14
(R.O. CM144408)





SEMIPULEGGE MOTRICI MOBILI
MOVABLE DRIVE HALF PULLEY

DERBI

10 032 0030 

50: Atlantis 02-10 • Atlantis 2T Eu2 07-09 • Atlantis 4T Eu2 07 • Atlantis 50-100 4T 04-06 • Atlantis 02 Bullet 03-05 • Atlantis 02 City 03-06 • Atlantis 02 Red Bullet 03 • Atlantis 02 Two Chic 05 • Atlantis 02 02 • Gp1 01-09 • Gp1 Eu2 05 • Gp1 Race Eu2 05-07 • Gp1 Open Eu2 06-09 • Gp1 01-03
(R.O. CM110301)



10 032 0040 

50: Atlantis 03-05 • Boulevard 09-14 • Sonar 09 • Variant Sport 2T 12
(R.O. CM110302)



10 032 0060 

125: Gp1 Eu2 06-Gp1 Low Seat Eu3 07-08 • Rambla 08
(R.O. CM144403)



10 032 0070 

125: Boulevard 04-12 • Sonar 4T 09-11 • Variant Sport 12
(R.O. CM103903)



10 032 0080 

150: Boulevard 02-04
(R.O. CM103901)



10 032 0170 

200: Boulevard 05-06
(R.O. CM144404)



10 032 0180 

150: Boulevard Eu2 04-07 • Boulevard Eu3 10 • Sonar 4T 09
(R.O. CM144401)



10 032 0190 

125: Boulevard Eu3 04-07 • Boulevard 4T Eu3 08-09
(R.O. CM144402)



10 032 0260 

250: Gp1 Low Seat Eu3 07-08 • Gp1 06-07
(R.O. CM144407)



10 032 0340 

250: Rambla Eu3 08 • Rambla 08-09
300: Rambla 10-11
(R.O. CM144408)





GILERA

10 032 0010 

50: Typhoon X 98-99 • Typhoon 94-97 • Easy Moving 95-96 • Storm 94-95
(R.O.430189)



10 032 0020 

50: Dna Gp Experience 03-04 • Runner Purejet St 08 • Runner Purejet 02-11 • Runner 97-00
(R.O.CM110304)



10 032 0030 

50: Dna 05-07-Runner Sp Special Edition 07 • Runner Sp St & Simoncelli 08-09 • Runner Sp 05-12 • Stalker Mod. < 03 97-04 • Storm Eu2 07 • Typhoon Xr 00
(R.O. CM110301)



10 032 0040 

50: Dna 00-02-Ice 01-05 • Runner Poggiali 02 • Runner Sp 02-04 • Stalker Naked 08 • Stalker Special Edition 07-08 • Stalker Mod. 03 > 97-11
(R.O. CM110302)



10 032 0060 

125: Nexus Eu3 ie 08-09 • Runner Vx 4T Eu3 07 • Runner Vx 4T St Eu3 08-13 • Runner Vx Race 06 • Runner Vx Sc 06-07 • Runner Vx-Vxr 00-07 • Runner Vx 05-06 • Dna 01
(R.O. CM103904 • CM144403)



10 032 0090 

125: Runner Fx-Fxr 97-02 • Typhoon X-Xr 99-00 • Typhoon 95-98
(R.O. CM102901)



10 032 0100 

200: Runner Vx-Vxr 02-04
(R.O. 832842)



10 032 0110 

180: Runner Fx-Fxr 97-02
(R.O. 487954)



10 032 0170 

200: Runner Vxr 4T St Eu3 08 • Runner Vxr Eu3 07 • Runner Vxr Race 06 • Runner Vxr 05-06
(R.O. CM144404)



HONDA

10 032 0230 

500: Fuoco 07-09 • Nexus Eu3 06-09 • Nexus Sp Eu3 06-07
(R.O. 833291)



10 032 0350 

125-150: Sh



10 032 0420 

125: Pcx





SEMIPULEGGE MOTRICI MOBILI
MOVABLE DRIVE HALF PULLEY

KYMCO

10 032 0380

50: Agility 4T Carry 11 • R10 06 • R12 05-08
 Rs 09 Like 4T 09



10 032 0400

125: Agility R16 08-12 • Movie 99-00 • People 99-00
 • People Eu2 03 • People Eu3 07-11 • People S 05 •
 People S Eu3 07-08 • Super8 08-09 • Vivio 00
150: Agility R16 08-09
200: People S 05 • People S I 07



10 032 0510

250: B&w 00 • B&w Eu2 03 • Grand Dink 01-02
 Grand Dink Eu2 03-04 • People Lc 03-04
 People S i 07 • People S 06 • X Citing 05 • X
 Citing i 06-07 • Yup 03



10 032 0490

500: X Citing 05-09



10 032 0430

125: Agility 4T Eu3 06-08 • Agility 4T 06 • Agility
 Carry 11 • Agility Rs 09 • Like Lx 12 • Like 09 • Movie
 Eu3 06-07 • Movie XL Eu2 03-04 • Movie XL 01
 • People One I 13
200: Agility i R16 10 • Agility R16 12 • Like i 09
 • Like Lx 12



MBK

10 032 0280

50: Scooter Vari - Motori Minarelli
Various scooter - Minarelli engine



10 032 0290

250: Yp Skyliner 00-03 • Yp Skyliner Abs 03
 (R.O. 5GM176200000)





PIAGGIO

10 032 0010 

50: Free FL 95-02 • Free 92-94 • Nrg 94-96 • Quartz 92-96 • Sfera Maquillage 2 94 • Sfera Rst 95-97 • Zip Rst 96-99 • Zip Bimodale 94-97 • Ntt 95-96 • Zip 95-96 • Zip Fast Raider 93-94 • Zip Fast Raider Rst 96-97
(R.O. 430189)



10 032 0020 

50: Liberty 4T 00-02 • Nrg Power Purejet 04-08 • Nrg Purejet 02-04 • Nrg Rst Mc2 96-98 • Vespa Et4 00-05 • Vespa S 4T-4V 08-09 • Zip 4T Mod. 2000 00-05 • Vespa Lx 4T-4V 09
(R.O. CM110304)



10 032 0030 

50: Diesis 01-Fly 4T Motore Chn 06-07 • Fly 4T 05-08 • Free Delivery 00-01 • Free FL Mod. 2002 95-02 • Liberty 4T Rst 04 • Liberty 4T Sport 06-08 • Liberty 4T 05-08 • Liberty Moc 4T 09 • Liberty 97-05 • Nrg Extreme 99-00 • Nrg Mc3 01-04 • Nrg Power Dd Serie Spec 07-08 • Nrg Power Dd 05-09 • Nrg Power Dt Serie Spec 07-08 • Nrg Power Dt 06-08 • Typhoon 01-09 • Vespa Et2 97-05 • Vespa Lx 4T 05-08 • Zip 4T 00-08 • Zip Sp Eu2 06-09 • Zip Sp 01-04
(R.O. CM110301)



10 032 0040 

50: Liberty 2T Rst 04 • Liberty 2T Sport 06-08 • Liberty 2T 06-08 • Liberty Moc 2T 09 • Liberty Ptt Eu2 04-05 • Liberty Mod. Cat. 2000 97-05 • Vespa Et2 Iniez. 97-00 • Vespa Lx 2T FL 09-10 • Vespa Lx 2T 05-08 • Vespa Lxv 2T Navy 08 • Vespa Lxv 2T 06-08 • Vespa S 2T 07-08 • Zip 2T 08-09 • Zip 00-04
(R.O. CM110302)



10 032 0050 

125: Hexagon Lx4 98-99 • Liberty 98-00 • Sfera 95-97 • Vespa Et4 96-98
(R.O. 82522R)



10 032 0060 

125: Beverly Eu 3 Mic 07 • Beverly Eu3 07-08 • Beverly Rst 04-07 • Beverly Rst 4T 4V ie Eu3 10-13 • Beverly 01-03 • Beverly Tourer Eu3 07-10 • Carnaby 07-10 • Hexagon Gtx 00 • Mp3 ie - Ibrido - Yourban ERL 08-12 • Super Hexagon Gtx 01-02 • Vespa Gt - Eu3 03-07 • Vespa Gts 4T ie - Navy - Eu3 07-13 • Vespa Gtv 07-08 • X Evo 07-12 • X10 4T 4V ie 12-13 • X7 Eu3 08-10 • X8 - Premium Eu3 05-07 • X9 - Evolution - Eu3 01-07
(R.O. CM144403)



10 032 0070 

125: Beverly 01-03
(R.O. CM103903)



10 032 0080 

150: Liberty Per Modelli < 2005 01-02 • Skipper 4T Per Modelli < 2005 00-02 • Vespa Et4 Per Modelli < 2005 99-02
(R.O. CM103901)



10 032 0090 

150: Skipper Lx 98-99
(R.O. 483981)





SEMIPULEGGE MOTRICI MOBILI
MOVABLE DRIVE HALF PULLEY

PIAGGIO

10 032 0100



180: Hexagon Gtx 00 • Super Hexagon Gtx 12 01-02 • X9 Amalfi 00-03
(R.O. 827693)



10 032 0110



180: Hexagon Lx-Lxt 98-99
(R.O. 487954)



10 032 0170



200: Carnaby 07-08 • Liberty 4T Eu3 07-08 • Liberty 4T Sport Eu3 06-07 • Liberty Sport 06 • Liberty 06 • Vespa Granturismo 06-07 • X8 05-07 • Beverly 01-03
(R.O. CM144404)



10 032 0180



150: Fly Eu3 08 • Fly 05-07 • Liberty 4T Eu3 08 • Liberty 4T Sport Eu3 08 • Liberty Moc 4T 09 • Vespa Lx 4T FL 09 • Vespa Lx Eu 3 ie 09 • Vespa Lx Eu 3 06-08 • Vespa Lx 05-06 • Vespa S 4T ie 09 • Vespa S 4T 08-09 • X8 Street Eu 2 06-08
(R.O. CM144401)



10 032 0190



125: Fly Eu3 07-08 • Fly 05-07 • Liberty 01-02 • Liberty 4T Eu3 Delivery 08 • Liberty 4T Eu3 07-08 • Liberty 4T Sport Eu3 06-08 • Liberty 4T 06-07 • Liberty Rst Ptt 05-06 • Liberty Rst 04-05 • Liberty Sport 06 • Skipper 4T 00-02 • Vespa Et4 99-02 • Vespa Lx 4T FL 09 • Vespa Lx Eu 3 06-08 • Vespa Lx 05-06 • Vespa Lxv 4T Eu3 06-09 • Vespa Lxv 4T Navy Eu3 08 • Vespa S 4T Eu 3 07-08 • X8 Street Eu 2 06-07 • Zip 00-02 • Vespa Lxv ie 4T 10 • Vespa S 4T ie 09
(R.O. CM144402)



10 032 0230



500: Beverly Cruiser 07-11 • Beverly Eu 3 06-08 • Beverly 02-06 • X9 Evolution Abs 06-07 • X9 Evolution 03-07 • X9 01-02
(R.O.833291)



10 032 0260



250: Beverly Rst 04-05 • Beverly 06-07 • Mp3 Lt 09 • Mp3 Mic 08-09 • Mp3 06-08 • Vespa Gt 60 Eu 3 06-07 • Vespa Gts, Gts Abs 05-09 • Vespa Gtv 4T Navy Eu3 08 • Vespa Gtv 06-09 • Xevo 07 • X7 Eu 3 08 • X8 Eu3 05-08 • X9 Evolution 04-06
(R.O. CM144407)



10 032 0330



400: Beverly Eu 3 06-07 • Beverly Tourer Eu3 08-09 • Mp3 Lt 09 • Mp3 Mic 08-09 • Mp3 07-08 • X Evo 07-09 • X8 Eu3 06-08
(R.O. 849913)



10 032 0340



250: Beverly 300 ie Tourer 09 • Carnaby Cruiser 09 • Vespa Gts Super 08 • X7 Evo ie Eu 3 09
300: Beverly 300 ie Tourer 09 • Carnaby Cruiser 09 • Vespa Gts Super 08 • X7 Evo ie Eu 3 09
(R.O. CM144408)





YAMAHA

10 032 0280 

50: Scooter Vari Per Motori Minarelli



10 032 0290 

250: Yp Majesty Abs 03 • Yp Majesty 00-01
• Yp Majesty 02-03
(R.O. 5GM176200000)



10 032 0360 

125: Vp X-City 08-11



10 032 0370 

250: Yp R X Max 06-12
300: Xc Versity 06





SEMPILEGGE CONDOTTE FISSE
FIXED DRIVEN HALF PULLEY ASSY

APRILIA

10 034 0070



50: Mojito 04-08 • Scarabeo 4T 02-06 • Scarabeo 4T 4V 09-12 • Scarabeo 4t Restyling Eu3 06-09 • Scarabeo Quattro 09 • Scarabeo Street 2T Restyling 06-09 • Sport City One 2T 08-11 • Sport City One 4T 08-10 • Sr R Factory 04-12 • Sr Street 03-08
100: Scarabeo 4T Net 10-12 • Scarabeo 4T Rst 06-09



10 034 0110



125: Mojito Retrò • Custom 99-01 (R.O. AP8550346)



10 034 0150



400-500: Atlantic Sprint 05-08 • Scarabeo light 06-08



10 034 0200



200: Atlantic 03-05 • Scarabeo 03
250: Atlantic 03-05 • Scarabeo 04-06
Sport City Eu3 06-08 (R.O. AP8580208)
300: Scarabeo Light 09 • Sport City Cube 08



10 034 0210



125: Atlantic 03-05 • Scarabeo 03- Sport City 04-06 • Sport City Street 12-13 • Sr Max 11-13 (R.O. AP8575013)



10 034 0100



Motori Minarelli - Aprilia 50 cc
(Per frizioni Ø 107)
For Minarelli - Aprilia Engines 50 cc
(For Ø 107 clutches)



10 030 0470



PERNO GUIDA VARIATORE - PULLEY PIN
APRILIA 50-100 • (R.O. AP8551041)
(Conf. 5 pz - 5 pcs set)





DERBI

10 034 0070 

50: Atlantis 02 02 • Boulevard 2T 09



10 034 0200 

250: Gp1 06-07 • Rambla 08



10 034 0210 

125: Boulevard 02-04 • Gp1 Eu2 06
150: Boulevard 02-04 • Boulevard Eu3 04-07
200: Boulevard 05



GILERA

10 034 0060 

50: Typhoon 94-97 • Typhoon X 98-99 • Easy Moving 95-96 • Storm 94-95
(R.O. 430190)



10 034 0070 

50: Dna 05-07 • Ice 01-05 • Runner 97-00 • Stalker 05-06 • Storm Eu2 07
(R.O. 479552)



10 034 0150 

500: Fuoco 07-09 • Nexus 03-05 • Nexus Eu3 06-08 •
(R.O. 832774-846696)



10 034 0200 

200: Runner Vxr 05-06 • Nexus Eu3 06-07
250: Nexus Sp Eu3 06-07 • Oregon 06-08
300: Nexus Eu3 08-09 • (R.O. 833669)



10 034 0210 

125: Nexus Eu3 07-08 • Runner Vx 05-06
(R.O. 830580)



MBK

10 034 0100 

Motori Minarelli - MbK 50 cc
(Per frizioni Ø 107)
For Minarelli - MbK Engines 50 cc
(For Ø 107 clutches)



10 034 0230 

250: Skyliner 00-03 - Abs 03
300: Kylibre 03
(R.O. 5GM176680010)





SEMIPULEGGE CONDOTTE FISSE
FIXED DRIVEN HALF PULLEY ASSY

PIAGGIO

10 034 0060



50: Free 92-94 • Free Fl 95-02 • Nrg 94-96 • Ntt 95-96 • Quartz 92-96 • Sfera Maquillage 2 94 • Vespa Et2 97-05 • Zip 95-96
(R.O. 430190)



10 034 0070



50: Diesis 01 • Fly 2T-4T 05-07 • Liberty 97-05 • Nrg Extreme 99-00 • Typhoon 01-04 • Vespa Et2 97-05 • Zip 00-04 • Zip 2T 08-09
100: Fly 4T 06-08 • Free 02-03 • Zip 4T 06-08
125: Vespa S 4T le 09
(R.O. 479552)



10 034 0110



125: Hexagon Lx4 8-99 • Liberty 98-00 • 125 Sfera 95-97 • Vespa Et4 96-98
(R.O. 4780745)



10 034 0150



400: Mp3 Mic 08-09
500: Beverly 02-06 • Beverly Cruiser 07-09 • X9 Evolution 03-05
(R.O. 832774-846696)



10 034 0200



200: Carnaby 07-08-X9 02-03 • Beverly 06-07
250: Carnaby 08 • Mp3 06-08 • Vespa Gt 60 Eu3 06-07
300: Beverly 300 le Tourer 09 • Carnaby Cruiser 09 • X7 Evo le Eu3 09
(R.O. 833669)



10 034 0210



125: Beverly 01-03 • Carnaby 07-09 • Fly 05-07 • Liberty 01-02 • Mp3 07-08 • Skipper 4T 00-02- Vespa Et4 99-02 • X7 Eu3 08-Zip 00-02
150: Fly 05-07-Liberty 4T Eu3 08 • Vespa Lx 05-06
180: X9 Amalfi 00-03
200: Liberty 06
(R.O. 830580)



10 034 0130



PULEGGIA - PULLEY

50: Ciao • Bravo • Si Monomarcia (No Variator)
Ø 90 mm
(R.O. 103049)



10 041 0010



**KIT RICAMBIO PER PULEGGIA
MOTRICE VARIATORE
REPLACEMENT KIT FOR PULLEY**

PIAGGIO: Ciao • Px • FL • Teen • Ciao tre Si • Si FL2 • Bravo • Superbravo • Boss • Grillo
Composto da: 8 Rulli, 16 Semigusci
Composed by 8 rolls • 16 Half shells
(R.O. 104559-60)



10 030 0470



**PERNO GUIDA VARIATORE - PULLEY PIN
PIAGGIO 50-100 • (R.O. 482766)**
(Conf. 5 pz - 5 pcs set)



YAMAHA

10 034 0100



**Motori Minarelli - Yamaha 50 cc
(Per frizioni Ø 107)
For Minarelli - Yamaha Engines 50 cc
(For Ø 107 clutches)**



10 034 0230



250: Vp X-City 07-12 • Yp Majesty Abs 03 • Yp Majesty Dx 98-99 • Yp Majesty 96-03 • Yp R Black X-Max 09 • Yp R X-Max Abs 11-12 • Yp R X-Max Sport 11-12 • Yp R X-Max 05-12
300: Xc Versity 03-06
(R.O. 5GM176680010)





APRILIA

10 034 0020

50: Mojito 04-08 • Scarabeo 4T 02-06 • Sport City One 2T-4T 08-09 • Sr Street 03-08
100: Scarabeo 4T 01-04
(R.O.AP8551055)



10 034 0050

Motori Minarelli - Aprilia 50 cc
(Per frizioni Ø 107)
For Minarelli-Aprilia Engines 50 cc
(For Ø 107 clutches)



10 034 0190

250: Atlantic 03-05 • Scarabeo 04-06
(R.O.AP8577055) • Sport City Eu3 • Cube 06-08
300: Scarabeo Light 09



10 034 0220

125: Atlantic Eu3 06-08 • Sport City 04-06
200: Scarabeo Light 07-08



DERBI

10 034 0020

50: Atlantis 2T-4T Eu2 07-09 • Gp1 01-03



10 034 0220

125: Gp1 Eu2 06 • Rambla 08
150-200: Boulevard 02-05
(R.O. 87899)



10 034 0190

250: Rambla 08-09 • Gp1 06-08
(R.O. 841774)



GILERA

10 034 0160

500: Fuoco 07-09
Nexus 03-05 • Nexus Eu3 06-09 • Nexus Sp Eu3
06-07
(R.O.832808)



10 034 0190

250: Nexus Eu3 06-07 • Nexus Sp Eu3 06-07 •
Oregon 06-08
300: Nexus Eu3 08-09
(R.O.841774)



10 034 0220

125: Nexus Eu3 07-08 • Runner Vx 05-06
180: Dna 01
(R.O.827499)





SEMIPULEGGE CONDOTTE SCORREVOLI

SLIDING DRIVEN HALF PULLEY

MBK

10 034 0050 

Motori Minarelli - MbK 50 cc
(Per frizioni Ø 107)
For Minarelli - MbK Engines 50 cc
(For Ø 107 clutches)



10 034 0030 

250: Skyliner 00-03 - Abs 03
300: Kylibre 03
(R.O. 4HC176701100)



PIAGGIO

10 034 0010 

50: Free FL 95-02 • Free 92-94 • Nrg Rst Mc2 96-98 • Nrg 94-96 • Ntt 95-96 • Quartz 92-96 • Sfera Maquillage 2 94 • Sfera Rst 95-97 • Vespa Et2 97-05 • Zip Bimodale 94-97 • Zip Fast Raider Rst 96-97 • Zip Fast Raider 93-94 • Zip Rst 96-99 • Zip Sp 96-00 • Zip 95-96
(R.O. 430191)



10 034 0020 

50: Fly 2T-4T 05-07 • Liberty 97-05 • Liberty 2T 06-08 • Liberty 4T 05-08 • Nrg Purejet 02-04 • Typhoon 01-09 • Vespa Et2/Et4 97-05 • Zip 00-04
100: Fly 4T 06-07 • Zip 4T 06-08
125: Vespa S 4T le 09
(R.O.827893) • (R.O.436875)



10 034 0120 

125: Hexagon Lx4 98-99 • Liberty 98-00 • Sfera 95-97 • Vespa Et4 96-98
(R.O.4780725)



10 034 0160 

400: Mp3 Mic 08-09
500: Beverly 02-06 • Beverly Cruiser 07-09
Beverly Eu3 06-08 • X9 Evolution 03-07 X9
Evolution Abs 06-07
(R.O.832808)



10 034 0190 

250: Beverly 06-07 • Beverly Cruiser 07-09 • Carnaby 08 • Mp3 06-08 • Vespa Gtv 06-09 • X7 Eu3 08 • X8 Eu3 05-08 • X9 Evolution 04-06
300: Beverly 300 le Tourer 09 • Vespa Gts Super 08 • X7 Evo le Eu3 09
(R.O.841774)



10 034 0220 

125: Beverly 01-03 • Beverly Eu3 07-08 • Carnaby 07-09 • Mp3 07-08 • Vespa Gt 03-07 • X8 04-06 (R.O.827499)
150: Fly 05-07 • Liberty 01-02 • Liberty 4T Eu3 08 • Vespa Et4 99-02 • Vespa Lx 05-06
180: Hexagon Gtx 00 • X9 Amalfi 00-03
200: Liberty 06 • Liberty 4T Eu3 07-08



YAMAHA

10 034 0050 

Motori Minarelli - Yamaha 50 cc
(Per frizioni Ø 107)
For Minarelli - Yamaha Engines 50 cc
(For Ø 107 clutches)



10 034 0030 

250: Vp X-City 07-12 • Yp Majesty Abs 03 • Yp Majesty Dx 98-99 • Yp Majesty 96-03 • Yp R Black X-Max 09 • Yp R X-Max Abs 11-12 • Yp R X-Max Sport 11-12 • Yp R X-Max 05-12
300: Xc Versity 03-06
(R.O. 4HC176701100)



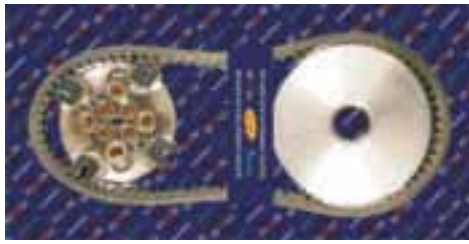

KIT PULEGGIA MOTRICE + CINGHIA DAYCO
FRONT PULLEY KIT + DAYCO BELT



CODICE KIT - CODE	DESCRIZIONE DESCRIPTION	CODICE RMS RMS CODE	RIFERIMENTI ORIGINALI OEM NUMBER			
			PIAGGIO	APRILIA	GILERA	
16 381 0010 	Semipuleggia Motrice - <i>Drive half pulley</i>	10 032 0280	-	-	-	
	Semipuleggia fissa - <i>Fixed pulley</i>	10 032 0210	-	-	-	
	Cinghia Dayco - <i>Dayco belt</i>	16 375 0082	-	-	-	
16 381 0020 	Semipuleggia Motrice - <i>Drive half pulley</i>	10 032 0290	-	-	-	
	Cinghia Dayco - <i>Dayco belt Kevlar</i>	16 375 0650	-	-	-	
16 381 0070 	Semipuleggia Motrice - <i>Drive half pulley</i>	10 032 0020	CM110304	CM110304	CM110304	
	Semipuleggia fissa - <i>Fixed pulley</i>	10 032 0130	PIAGGIO GILERA APRILIA 50 cc	479561	AP8551033	479561
	Cinghia Dayco - <i>Dayco belt</i>	16 375 0060		82712R	82712R	82712R
16 381 0080 	Semipuleggia Motrice - <i>Drive half pulley</i>	10 032 0060	CM144403	-	-	
	Semipuleggia fissa - <i>Fixed pulley</i>	10 032 0310	PIAGGIO 125 cc	845607	-	-
	Cinghia Dayco - <i>Dayco belt Kevlar</i>	16 375 0600		842009	-	-



DISCO CONTENITORE RULLI

ROLLER WEIGHT HOUSING

10 030 0090



APRILIA 125: Mojito 03-08 • Sport City One 08
DERBI 125: Boulevard 02-04
GILERA 125-180-200: Dna 01
 • Runner Vx • Vxr 00-02
PIAGGIO 125: Beverly 01-03 • Fly 05-07
 • Liberty 01-02 • Vespa Et4 99-02 • Vespa
 Lx 05-06 • X8 Street Eu2 06-07 • Zip 00-02
 (R.O.485710)



10 030 0100



GILERA 50: Easy Moving 95-96 • Storm 94-95
 • Typhoon 94-97
PIAGGIO 50: Free 92-94 • Free FL 95-02 • Nrg
 94-96 • Quartz 92-96 • Sfera Maquillage 2 94 •
 Sfera Rst 95-97 • Zip Rst 96-99
 (R.O. 430189)



10 030 0110



APRILIA 50: Mojito 04-08 • Scarabeo 4T Rst
 Eu3 06-09 • Sport City One 2T-4T 08-09 • Sr
 Street 03-08
DERBI 50: Atlantis 02 • Atlantis 2T-4T Eu2 07-
 09 • Boulevard 2T 09 • Gp1 01-0
GILERA 50: Dna 00-07 • Ice 01-05 • Runner 97-00
 • Stalker 97-09 • Storm Eu2 07 • Typhoon Xr 00
PIAGGIO 50: Diesis 01 • Fly 2T-4T 05-07 • Free
 FL 95-02 • Liberty 97-05 • Liberty 2T 06-08
 • Liberty 4T 00-08 • Nrg Purejet 02-04
 • Typhoon 01-09 • Vespa Et2-Et4 97-05 • Vespa
 Lx 2T 05-08 • Vespa Lx 4T 05-08 • Zip 00-04 •
 Zip 2T-4T 08-09
100: Fly 4T 06-08 • Free 02-03 • Zip 4T 06-10
 (R.O. 480227)



10 030 0150



APRILIA 125: Atlantic 03-05 • Scarabeo 03-06 •
 Sport City 04-06
200: Sport City 04-06 • Sport City Cube 08 •
 Sport City Eu3 06-08
250: Sport City Eu3 06-08
DERBI 125: Gp1 Eu2 06 • Rambla 08
200: Boulevard 05 • **250:** Gp1 06-07
GILERA 125: Dna 01 • Nexus Eu3 ie 08-09
200: Runner Vxr Eu3 07
250: Nexus Eu3 07 • Oregon 06-08
PIAGGIO 125: Beverly Tourer Eu3 08-09 •
 Carnaby 07-09 • Hexagon Gtx 00 • Mp3 07-08 •
 Vespa Gt Eu3 06-07
150: Fly 05-07 • Liberty 01-02 • Liberty 4T
 Eu3 08 • Vespa Et4 99-02 • Vespa Lx 05-06 • X8
 Street Eu2 06-08
180: Hexagon Gtx 00 • Super Hexagon Gtx 12"
 01-02 • X9 Amalfi 00-03
200: Beverly 01-03 • Carnaby 07-08 • Liberty
 4T Eu3 07-08 • Vespa Gt 03-07
250: Beverly 06-07 • Mp3 06-08 • X7 • X8 Eu3
 05-08
300: Beverly Rst 4T 4V ie Eu3 10-11 • Beverly
 Tourer Eu3 09-10 • Carnaby Cruiser 09-11 •
 Mp3 ie Lt 10-11 • Mp3 ie Mic 10-11 • Mp3 4T
 4V ie Lt Ibrido 10-11 • Mp3 ie Lt Touring 11 •
 Mp3 ie Lt ie Lt Sport 11 • Mp3 ie Touring 11 •
 Mp3 Yourban Erl 11 • Mp3 Yourban Lt Erl 11
 • Vespa Gts ie Touring 11 • Vespa Gts Super
 Sport 10-11 • Vespa Gts Super 08-11 • Vespa
 Gtv 4T 4V ie 10-11 • Vespa Gtv Via Montenapo-
 leone 10 • X7 Evo ie Eu 3 09-10
 (R.O. 842204)



10 030 0120



GILERA 180: Runner Fx • Fxr 97-02
PIAGGIO 125-150-180: Hexagon Lx
 Lxt 98-99 • Skipper Lx 98-99
 (R.O. 435893)



10 030 0210



APRILIA 500: Atlantic 01-04 • Atlantic Sprint
 05-08 • Scarabeo Light 06-08
GILERA 500: Fuoco 07-09 • Nexus Eu3 06-09
 • Nexus Sp Eu3 06-07
PIAGGIO 500: Beverly 02-06 • Beverly Cruiser
 07-09 • Beverly Eu3 06-08 • X9 Evolution 03-07
 • X9 Evolution Abs 06-07
 (R.O. 829344)



10 030 0130



APRILIA 125: Mojito Retro' • Custom 99-01
PIAGGIO 125: Hexagon Lx4 98-99 • Liberty
 98-00 • Sfera 95-97 • Vespa Et4 96-98
 (R.O. 436699)



10 030 0220



APRILIA 400-500 : Atlantic Sprint 05-08
 • Scarabeo Light 06-08
GILERA 500: Fuoco 06-10 • Nexus Eu3 06-10
PIAGGIO 400 Beverly Tourer Eu3 06-07 • Mp3
 07-08 • X Evo 07-09 • X8 Eu3 06-08
500: Beverly Cruiser 07- 08 • Beverly 05-06 • X9
 Evolution 06-07
 (R.O. 830901)



10 030 0140



MINARELLI-MBK-YAMAHA 50 cc
 (R.O.3VLE76230000)



10 050 0010 
MINARELLI-MBK-YAMAHA 50
 (Kit 3 pezzi - *Kit 3 pcs*)

10 050 0020 
GILERA PIAGGIO 50: (Tutti i modelli-*All Models*)
PIAGGIO100: Free
 (R.O. 289931)
 (Kit 3 pezzi - *Kit 3 pcs*)

10 050 0040 
PIAGGIO: Beverly 500 02-04
 X9 Evolution 500 03-04
 (Kit 3 pezzi - *Kit 3 pcs*)
 (R.O. 833293)

10 050 0050 
PIAGGIO: Beverly 400-500 • X8 400
 (Kit 4 pezzi - *Kit 4 pcs*)
 (R.O. 842175)

10 050 0060 
PIAGGIO: Beverly Rst 250 04-05
 Beverly Euro 3 250 • 06-X8 250 05-06
 Vespa Gts 250 05-06
 (Kit 3 pezzi - *Kit 3 pcs*)
 (R.O. 843028)

10 050 0080 
CON DISTANZIALE - WITH SPACER
YAMAHA 250: Yp Majesty Abs 03 • Dx 98-00
 Yp Majesty 96-03 • Xc Versity 03-06
MBK 250-300: Yp Skyliner Abs 03 • Yp Skiliner
 00-03 • Xc Kilibre 03
 (Kit 4 pezzi - *Kit 4 pcs*)
 (R.O. 4H176530000+4HC176540000)

10 050 0090 
HONDA 125-150: Sh
 (Kit 3 pezzi - *Kit 3 pcs*)

10 050 0100 
PIAGGIO 125: Liberty-Beverly
 (Kit 3 pezzi - *Kit 3 pcs*)
 (R.O. 434855)

10 050 0110 
GILERA 125: Runner
 (R.O. 431280)
 (Kit 6 pezzi - *Kit 6 pcs*)

10 050 0120 
CON DISTANZIALE - WITH SPACER
YAMAHA 250: X Max 05-10
 (Kit 4 pezzi - *Kit 4 pcs*)

10 050 0130 
YAMAHA 125: X-Max
 (Kit 3 pezzi - *Kit 3 pcs*)
 (R.O. 1B9E76530000)

10 050 0160 
YAMAHA 400: Xp X/Max 13-14
 (Kit 4 pezzi - *Kit 4 pcs*)
 (R.O. 1SDF581T0000)

12 185 5070 
**PIASTRINA TRAINO - FIXED PULLEY
 TOOTHED WASHER**
MINARELLI-MBK-YAMAHA 50
 (R.O. 902141305800)

14 274 0060 
**VENTOLA PULEGGIA MOTRICE
 DRIVING PULLEY FAN**
GILERA 50: Dna 00-01 • Ice 01 • Stalker 97-01
 • Typhoon XR 00 • Runner 97-00 • Poggiali - FL
 - Purejet 02
PIAGGIO 50: Diesis 01 • Free Delivery 00-01
 • Liberty 97-02 • 4T 00-02 • Nrg Rst Mc2 96-98
 • Extreme 99-00 • MC3 01-02 • Purejet 02
 • Typhoon 01 • Vespa Et2 97-01 • Et4 00-02
 Zip 2/4 T 00 • Rst 96-99 • SP 01
100: Free 02

14 274 0070 
**VENTOLA PULEGGIA MOTRICE
 DRIVING PULLEY FAN**
PIAGGIO: Free 92-94 • FL 95-00 • Ntt 95-96
 • Nrg 94-96 • Rst Mc2 96-98 • Quartz 92-96
 • Sfera base 91-93 • Maquillage 2 94 • Rst 95-97
 • Vespa Et2 97-01 • Zip & Zip bimodale 94-97
 • Zip base 92-96 • Rst 96-99 • Zip fast raider
 • Rst 96-97 • Fast raider 93-94 • Sp 00



KIT RULLI PULEGGIA MOTRICE

DRIVING PULLEY ROLLER SETS

MM 15 x 12

GRAMMATURE DISPONIBILI - WEIGHTS				
CODICE	•	•	BARCODE	N° Gr.
10 041 0230				6 2,3
10 041 0330				6 3,3
10 041 0350				6 3,5
10 041 0400				6 4
10 041 0430				6 4,3
10 041 0470				6 4,7
10 041 0500				6 5
10 041 0520				6 5,2
10 041 0550				6 5,5
10 041 0580				6 5,8
10 041 0620				6 6,2
10 041 0650				6 6,5
10 041 0680				6 6,8
10 041 0700				6 7
10 041 0720				6 7,2
10 041 0750				6 7,5
10 041 0770				6 7,7
10 041 0810				6 8,1
10 041 0830				6 8,3
10 041 0860				6 8,6
10 041 0900				6 9

MODELLO - MODELS	CC	ANNO YEAR	Gr.
APRILIA			
Amico	50	92-98	6,5
Amico Lx-Sport	50	92-93	6,5
Gulliver	50	95-98	6,5
Rally	50	95-03	6,5
Scarabeo	50	93-06	6,5
Scarabeo I.E. (Di Tech)	50	02	8,6
Sr (Cil.Orizz. Raff. Aria)	50		5,2
Sr Lc Stealth Racing www	50	94-01	6,5
Scarabeo Mot Minarelli	100	00	7,5
Carosello	50		7
BENELLI			
491 Gt	50	98-99	6,5
491 Rr	50	98-01	5,5
Naked	50	02	6,5
Pepe	50	99-01	6,5
BETA			
Ark AC/LC	50	96-08	5,5
Elkon	50	99-03	6,8
Quadra Chrono 502	50	96-99	5,5
Tempo	50	94-95	7
CAGIVA			
City	50	91-94	7,5
ITALJET			
Bazooka	50		6,5
Pista	50		6,5
MALAGUTI			
Centro Base	50	93-94	7
Centro Sl-Kat	50	94-98	7
Crosser Cr1	50	95-98	5,5
F10 Kat	50	99-00	6,5
F12 Phantom	50	94-98	6,5
Yesterday - Euro	50	97-00	6,5

MODELLO - MODELS	CC	ANNO YEAR	Gr.
MBK			
Booster	50	01-02	6,2
Booster Road	50	94-95	6,5
Booster Spirit Eu2	50	02-03	6,2
Evolis	50	94-95	7
Fizz	50	94-95	7
Flipper - Cat	50	98-02	6,5
Ovetto Eu1-Eu2	50	02-04	6,5
Sorriso	50	91-92	6,5
Booster	100	99-01	8,3
Nitro	100	00-02	9
Ovetto	100	00-02	9
YAMAHA			
Aerox	50	97-12	5,5
Breeze	50	94-95	7
Bw'S	50	04-12	5,5
Bw'S-Naked	50	03-04	6,2
Bw'S-Naked	50	09-12	5,5
Bw'S Ng	50	04-06	5,5
Bw'S Original Eu2	50	02-03	6,2
Jog R	50	02-11	6,5
Neo'S	50	97-12	6,5
Slider	50	00-02	6,2
Spy	50	95-98	7
Why	50	98-02	6,5
Aerox	100	00-02	9
Bw'S	100	99-01	8,3
Neo'S	100	99-02	9



MM 16 x 13

GRAMMATURE DISPONIBILI - WEIGHTS					MODELLO - MODELS				MODELLO - MODELS				
CODICE	●	●	BARCODE	N°	Gr.	CC	ANNO YEAR	Gr.	CC	ANNO YEAR	Gr.		
10 042 0270				6	2,7	GILERA				Sniper	50	93	7,5
10 042 0360				6	3,6	Easy Moving 50 95-96 8,5				Super 8	50	07	6,5
10 042 0400				6	4	Storm 50 94-95 8,5				Super 8 2T	50	13	8,5
10 042 0470				6	4,7	Typhoon 50 94-97 8,5				Super 9	50	00	8,5
10 042 0500				6	5	HONDA				Super 9 Sport Eu2	50	03	8,5
10 042 0510				6	5,1	Gp Dio 50 91 8,5				Top Boy	50	97-00	8,5
10 042 0550				6	5,5	Sh 50 96 9				Vitality 2T	50	04	8,5
10 042 0570				6	5,7	Shadow 50 9				Vitality 4T	50	04	6,5
10 042 0620				6	6,2	Sj Bali 50 93 8,5				Yup	50	02	8,5
10 042 0650				6	6,5	Sky 50 97 5				PEUGEOT			
10 042 0670				6	6,7	Vision Prima Serie 50 85-87 7,5				Buxy	50	94-97	9
10 042 0700				6	7	Nps Zoomer 50 - 5,5				Elyseo	50	99	9
10 042 0750				6	7,5	Sh 100 96-99 10				Looxor	50	01-03	9
10 042 0800				6	8	Sj Bali 100 96-99 10				Metal-X	50	02	9
10 042 0850				6	8,5	KYMCO				Speedake (Keihin)	50	95-97	7,5
10 042 0900				6	9	Agility 4T R10 50 06 6,5				Speedake (Mikuni)	50	95-97	9
10 042 0950				6	9,5	Agility 4T R12 50 07-08 6,5				Speedfight AC-LC	50	97-98	9
10 042 1000				6	10	Agility 4T R16 50 08-12 6,5				Squab	50	95-97	9
10 042 1050				6	10,5	Agility 2T R16 50 10 8,5				Sv Geo	50	91-95	11
10 042 1100				6	11	Agility Plus 2T 50 14 8,5				Sv Geo (Mod.94)	50	91-95	8,5
						B&W 50 02 8,5				Trekker	50	98-00	9
						Dink 50 4T 50 07 6,5				Vivacity	50	99	9
						Dink Classic Eu2 50 03 8,5				Zenith L	50	94-96	8,5
						Dink Lc 50 98-02 8,5				PGO			
						Fever Zx 50 99-00 8,5				Bic Max	50		8,5
						Heroism 50 95-97 7,5				PIAGGIO			
						Like 2T 50 09 8,5				Free	50	95-02	8,5
						Like 4T 50 09 6,5				Nrg	50	94-96	8,5
						Mxer 50 02-03 7,5				Nrg Rst Mc2 (96-97)	50	96-98	7
						People 50 99-00 8,5				Ntt	50	95-96	8,5
						People Eu2 50 03 8,5				Quartz	50	92-96	8,5
						People Eu2 50 08-11 8,5				Sfera Rst	50	95-97	8,5
						People S 50 05-08 8,5				Zip Rst	50	96-99	8,5
						Sento 50 08 6,5				Zip Fast Rider-Bimodale	50	94-97	8,5

MM 17 x 12

GRAMMATURE DISPONIBILI - WEIGHTS					MODELLO - MODELS				
CODICE	●	●	BARCODE	N°	Gr.	CC	ANNO YEAR	Gr.	
10 043 0300				6	3	APRILIA			
10 043 0360				6	3,6	Habana Kat 50 7,5			
10 043 0400				6	4	Sr (Mod.00 Mot Suzuki) 50 7,5			
10 043 0460				6	4,6	Sr Di Tech (Mod.01) 50 7,5			
10 043 0520				6	5,2	ATALA			
10 043 0550				6	5,5	Hacker 50 5,5			
10 043 0580				6	5,8	CAGIVA			
10 043 0600				6	6	Progress 50 97-99 6			
10 043 0630				6	6,3	DERBI			
10 043 0660				6	6,6	Atlantis 50 99-01 7,2			
10 043 0680				6	6,8	Atlantis Kat (Raff. Aria) 50 5,8			
10 043 0720				6	7,2	Atlantis Lc 50 99-01 7,2			
10 043 0750				6	7,5	Hunter 50 96-97 6,3			
10 043 0830				6	8,3	Paddock Lc 50 98-01 6			
10 043 0870				6	8,7	Predator Lc 50 98-01 7,2			
						ITALJET			
						Formula Lc 50 97 5,5			
						MALAGUTI			
						Ciak 100 99-00 6,6			
						SUZUKI			
						Address 50 92-95 6,6			
						Katana V-Y 50 97-00 7,2			
						Sepia S 50 95-97 6,6			
						Zillion 50 99 6,8			
						Ay-Ajw K1-K4 50 01-04 6,6			



KIT RULLI PULEGGIA MOTRICE

DRIVING PULLEY ROLLER SETS

MM 17 x 13,5

GRAMMATURE DISPONIBILI - WEIGHTS				
CODICE	•	•	BARCODE	N° Gr.
10 044 0510				6 5,1
10 044 0520				6 5,2
10 044 0660				6 6,6
10 044 0700				6 7

GRAMMATURE DISPONIBILI - WEIGHTS				
CODICE	•	•	BARCODE	N° Gr.
10 044 0840				6 8,4
10 044 0900				6 9
10 044 0940				6 9,4

MODELLO - MODELS	CC	ANNO YEAR	Gr.
PIAGGIO			
Sfera	50	91-93	5,2
Zip	50	92-93	5,2

MM 18 x 14

GRAMMATURE DISPONIBILI - WEIGHTS				
CODICE	•	•	BARCODE	N° Gr.
10 040 0710				6 12,7
10 040 0090				6 13
10 040 0092	•			6 13
10 040 0230				6 13,5
10 040 0720				6 14
10 040 0100				6 14,5
10 040 0240				6 15,5

MODELLO - MODELS	CC	ANNO YEAR	Gr.
HONDA			
Nsc Vision	110	-	14,5
KYMCO			
Agility 4T	125	06	13,5
Agility 4T Eu3	125	06-08	13,5
Agility R16	125	09-12	13
Agility Carry	125	11-12	13,5
Agility R16	125	09-12	13
Agility Plus	125	14	13
Downtown 125I	125	09	13
Downtown I	125	09	13
Heroism	125	95-97	13
Heroism	125	95-97	13
K-Xct I	125	12-14	13
Like	125	09	13,5
Like Lx	125	12	13,5
Movie	125	99-00	13
Movie	125	99-00	13
People	125	99-00	13
People Eu3	125	07-11	13
People S	125	05	13
People Gti	125	10-12	13
People Eu2	125	03	13
People	125	99-00	13
People Eu3	125	07-11	13
People Gti	125	10	13
People S DD Eu3	125	07-08	13
People S	125	05	13
Super 8	125	08-09	13
Super 8	125	08-09	13

MODELLO - MODELS	CC	ANNO YEAR	Gr.
Vivio	125	00	13
Vivio	125	00	13
People One I	125	13-14	13,5
Agility R16	150	08-09	13
Agility	150	08-09	13
Heroism	150	95-97	14,5
Movie 150 Eu3	150	06-07	15,5
People	150	99-00	14,5
Vivio	150	00	14,5
Agility R16	200	10-12	13,5
Like 200I	200	09	13,5
Like Lx	200	12	13,5
People S	200	05	13
People S I	200	07	13
Agility Plus	200	14	13,5
Agility I Plus	200	14	13
MALAGUTI			
Ciak	125	00-01	13
Ciak Master	125	04	13
Ciak Master Eu3	125	06	13
Ciak	150	00-02	14,5
Ciak Master	150	04	14,5
Ciak Master Eu2	200	06	13
APPLICAZIONI VARIE			
-	-	-	12,7
-	-	-	14

MM 18 x 15

GRAMMATURE DISPONIBILI - WEIGHTS				
CODICE	•	•	BARCODE	N° Gr.
10 040 0010				6 10,7

MODELLO - MODELS	CC	ANNO YEAR	Gr.
APRILIA			
Leonardo (I Serie)	125	96-98	10,7

MM 19 x 14

GRAMMATURE DISPONIBILI - WEIGHTS				
CODICE	•	•	BARCODE	N° Gr.
10 040 0130				6 12

MODELLO - MODELS	CC	ANNO YEAR	Gr.
APRILIA			
Mojito Retro' - Custom	125	99-01	12
ITALJET			
Torpedo	125	98-00	12

MODELLO - MODELS	CC	ANNO YEAR	Gr.
PIAGGIO			
Hexagon Lx4	125	98-99	12
Liberty	125	98-00	12
Sfera	125	95-97	12
Vespa Et4	125	96-98	12



MM 19 x 15,5

GRAMMATURE DISPONIBILI - WEIGHTS				
CODICE	●	●	BARCODE	N° Gr.
10 045 0370				6 3,7
10 045 0400				6 4
10 045 0430				6 4,3
10 045 0480				6 4,8
10 045 0530				6 5,3
10 045 0532 (CM1102035)	●			6 5,3
10 045 0550				6 5,5
10 045 0570				6 5,7
10 045 0600				6 6
10 045 0630				6 6,3
10 045 0642 (CM1102025)	●			6 6,4
10 045 0650				6 6,5
10 045 0680				6 6,8
10 045 0720				6 7,2
10 045 0750				6 7,5
10 045 0752 (CM1102015)	●			6 7,5
10 045 0780				6 7,8
10 045 0830				6 8,3
10 045 0870				6 8,7
10 045 0982 (CM1102045)	●			6 9,8

MODELLO - MODELS	CC	ANNO YEAR	Gr.
APRILIA			
Mojito	50	04-08	6,4
Scarabeo 4T 4V	50	10-12	5,3
Scarabeo Quattro	50	09	5,3
Scarabeo 2T	50	09-12	7,5
Scarabeo Street	50	05-06	7,5
Sport City One 2T	50	08-11	7,5
Sport City One 4T	50	08-10	6,4
Sr R Factory Carb.	50	10-12	5,3
Sr R Factory Ie	50	10-12	5,3
Sr R R Factory (Iniez)	50	04-09	5,3
Sr R R Factory Carb)	50	04-09	6,4
Sr Street (Carb.)	50	03-08	6,4
Sr Street (Iniez)	50	03-08	5,3
DERBI			
Atlantis 02 Bullet	50	03-05	6,4
Atlantis 50 4T	50	04-06	6,4
Atlantis 2T Eu2	50	07-10	6,4
Gp1	50	01-03	5,3
GILERA			
Dna	50	03-07	6,4
Dna	50	00-02	7,5
Ice	50	01-05	7,5
Runner	50	97-00	5,3
Runner Purejet	50	02-11	5,3
Stalker	50	97-11	7,5
Storm Eu2	50	07	6,4
Typhoon 2T Eu2-3	50	10-12	7,5
PIAGGIO			
Diesis	50	01	6,4
Fly 2T	50	10-11	7,5
Fly 4T	50	08-11	9,8
Fly 4T	50	12	5,3

MODELLO - MODELS	CC	ANNO YEAR	Gr.
Fly 4T 4V	50	12-13	5,3
Free Delivery	50	00-01	6,4
Liberty	50	97-05	6,4
Liberty (Cat.'00)	50	97-05	7,5
Liberty 2T	50	06-11	7,5
Liberty 4T	50	00-02	5,3
Liberty 4T	50	05-08	6,4
Liberty Ptt Eu2	50	04-11	7,5
Nrg Mc3	50	01-04	6,4
Nrg Purejet	50	10-11	5,3
Typhoon	50	01-09	6,4
Vespa Et2	50	97-05	6,4
Vespa Et2 Iniezione	50	97-00	7,5
Vespa Et4	50	00-05	5,3
Vespa Lx 2T	50	05-08	7,5
Vespa Lx 4T 4V	50	09-13	5,3
Vespa Lx 4T-4V Touring	50	10-13	5,3
Vespa S 4T-4V	50	08-09	5,3
Vespa S 4T-4V & College	50	08-12	5,3
Vespa S 2T	50	07-11	7,5
Vespa Primavera 4T-4V	50	13.15	5,3
Vespa Sprint 4T-4V	50	14	5,3
Zip	50	00-04	7,5
Zip 2T	50	08-11	7,5
Zip 4T	50	00-12	6,4
Zip 4T	100	06-10	9,8



KIT RULLI PULEGGIA MOTRICE

DRIVING PULLEY ROLLER SETS

MM 19 x 17

GRAMMATURE DISPONIBILI - WEIGHTS				
CODICE	•	•	BARCODE	N° Gr.
10 040 0250				6 7
10 040 0252 (CM1038045)	•			6 7,3
10 040 0260				6 8
10 040 0692 (CM1038035)	•			6 8,6
10 040 0272 (CM1038015)	•			6 10
10 040 0972	•			6 10,4
10 040 0270				6 9,5
10 040 0290		•		6 11
10 040 0160				6 12,5
10 040 0300				6 13
10 040 0140				6 15
10 040 0982	•			6 15,6

MODELLO - MODELS	CC	ANNO YEAR	Gr.
APRILIA			
Atlantic Eu3	125	06-08	7,3
Mojito	125	03-08	8
Scarabeo Light	125	07-09	8
Sport City	125	04-06	7,3
Sr	125	99-01	13
Sr Motard	125	12	8
Sr	150	99-01	13
DERBI			
Boulevard	125	02-04	8,6
Boulevard 4T Eu3	125	08-12	8
Gp1 Eu2	125	06	7,3
Rambla	125	08	7,3
Boulevard	150	02-04	10
GILERA			
Dna	125	01	7,3
Nexus Eu3 le	125	08-09	7,3
Runner Fx-Fxr	125	97-02	15
Runner Vx	125	05-06	7,3
Typhoon	125	95-98	13
PIAGGIO			
Beverly '02	125	02	7,3
Beverly '01 e '03	125		8,6
Beverly Eu3	125	07-08	7,3
Beverly Tourer Eu3	125	08-09	7,3
Carnaby	125	07-09	7,3
Fly	125	05-07	8
Fly 4T 3V le Eu3 Dt-Lem	125	12-13	10
Fly 4T 3V le Eu3 Lem	125	12-13	10,4
Fly 4T 3V le E3 Dt	125	13-15	10,4
Fly 4T 3V le Eu3 Lem	125	12-13	10,4
Hexagon	125	94-97	13
Hexagon Gtx	125	00	7,3

MODELLO - MODELS	CC	ANNO YEAR	Gr.
Liberty	125	01-02	8,6
Liberty 4T	125	06-07	8,6
Mp3	125	07-08	7,3
Super Hexagon Gtx 12"	125	01-02	7,3
Typhoon 4T 2V Eu3	125	10-11	8,6
Vespa Et4	125	99-02	8,6
Vespa Granturismo	125	03-07	7,3
Vespa Lx	125	05-06	8,6
Vespa Lx 4T 3V le-Touring	125	13	10
Vespa Lx 4T 3V le - Touring	125	12-13	10,4
Vespa Lx 4T 3V le - Touring	125	12-13	10,4
Vespa S 4T 3V le	125	12	10,4
Vespa S 4T 3V le	125	12	9,5
Vespa 946 4T 3V Abs	125	12-13	10
Vespa 946 4T 3V Abs	125	13-15	10,4
X8	125	04-06	7,3
X9	125	01-02	7,3
X9 Evolution	125	03-06	7,3
Zip	125	00-02	8,6
Fly	150	05-11	10
Liberty	150	01-02	10
Liberty Moc 4T	150	09-10	10
Liberty 4T 3V Lem	150	13-14	15,6
Skipper	150	94-97	12,5
Skipper Lx	150	98-99	13
Vespa Et4	150	99-02	10
Vespa Lx	150	09-11	10
Vespa Lt 3V IE	150	14	15,6
Vespa Gts Super le 4T 3V	150	14-15	15,6
Vespa Primavera 4T-3V	150	13-15	15,6
Vespa S 4T ie	150	09-11	10
Vespa Sprint 4T 3V le	150	15	15,6



MM 20 x 12

GRAMMATURE DISPONIBILI - WEIGHTS				
CODICE	●	●	BARCODE	N° Gr.
10 040 0340				6 8,5
10 040 0350				6 9
10 040 0360				6 9,6
10 040 0370				6 10,5
10 040 0220				6 12
10 040 0780				8 12,5
10 040 0952	●			8 12,5
10 040 0380				6 15,3
10 040 0760				8 10
10 040 0390				8 11,5
10 040 0770				8 12
10 040 0912 (52SE76320000)	●			6 13
10 040 0400				8 13,5
10 040 0040				8 14
10 040 0410				8 15,3

MODELLO - MODELS	CC	ANNO YEAR	Gr.
APRILIA			
Leonardo	250	99-04	14
BENELLI			
Velvet	125	99-01	9
Velvet	150	99-01	9,6
Velvet	250	99-01	14
KYMCO			
Downtown I	200	10	12,5
People Gti	200	10-14	12,5
Downtown I	300	09-11	15,3
Downtown Abs - Abs i	300	10-12	15,3
K-Xct I Abs	300	14	15,3
K-Xct I Abs	300	12	15,3
People Gti	300	14	15,3
People Gti Abs	300	12-14	15,3
ITALJET			
Jupiter 4T	125		9
Millennium	125		9
Jet Set 4T- Millennium	150		9,6
MALAGUTI			
Madison	125	99-01	8,5
Phantom Max	125	03	9,6
Madison T	150	99-01	9,6
Madison S	250	99-01	13,5
MBK			
Doodo	125	00-01	10,5
Flame - R	125	97	12
Skyliner	125	98-02	8,5

MODELLO - MODELS	CC	ANNO YEAR	Gr.
Thunder	125	01-02	10,5
Skyliner	150	00-02	9,6
Skyliner	180	03	15,3
Skyliner	250	00-03	11,5
Skyliner Abs	250	03	11,5
Kilibre	300	03	15,3
YAMAHA			
Cygnus - Cygnus R	125	95-98	12
Hw Xenter	125	12-15	13
Majesty	125	98-00	8,5
Majesty	125	01-02	14
Majesty	125	03-05	10,5
Teo'S	125	00	10,5
X-City	125	08-11	10,5
X-Max	125	06-12	10,5
Xc R Majesty S	125	14	13
Yw Bw's	125	10	12
Yp R X-Max	125	10-14	10,5
Majesty	150	00-02	9,6
Hw Xenter	150	12	13
Versity	150	03-06	15,3
Majesty	180	03-06	15,3
Majesty	250	00-03	11,5
Majesty	250	96-98	14
X-City	250	08-12	12
X-Max	250	05-09	14
X-Max	250	08-10	12

MM 20 x 15

GRAMMATURE DISPONIBILI - WEIGHTS				
CODICE	●	●	BARCODE	N° Gr.
10 040 0420				6 7,3
10 040 0430				6 11,5
10 040 0440				6 12,5
10 040 0170				6 13
10 040 0110				6 13,5
10 040 0902	●			6 14
10 040 0120				6 14,5
10 040 0450				6 15,5
10 040 0460				6 16,5
10 040 0962				6 18
10 040 0992	●			6 19,2

MODELLO - MODELS	CC	ANNO YEAR	Gr.
APRILIA			
Scarabeo 4T	100	01-04	7,3
Scarabeo 4T Rst	100	06-09	7,3
Scarabeo 4T-Net	100	10-12	7,3
HONDA			
Chiocciola	125	00-06	11,5
Dylan	125	01-06	11,5
Nes	125	00-07	11,5
Sh 125 - 125I	125	01-12	11,5
Pcx	125	10-13	16,5
Pantheon	125	03-05	12,5
Ps	125	06-10	11,5
Chiocciola	150	00-06	12,5
Dylan	150	01-06	12,5
Nes	150	00-07	12,5
Sh 150 - 150I	150	01-08	12,5
Ps	150	06-10	12,5
Pcx	150	10-14	18
KYMCO			
B&W	125	00	13,5
Dink	125	97-98	13,5
Grand Dink	125	01-02	13,5
B&W	150	97-00	14,5

MODELLO - MODELS	CC	ANNO YEAR	Gr.
B&W Eu2	150	03-04	14,5
Dink Lx	150	98-00	14,5
Grand Dink Eu2	150	01-04	16,5
Dink Classic	200	04	16,5
MALAGUTI			
Blog Ie	125	09-11	11,5
Centro Ie	125	08-11	11,5
F18 Warrior	125	00-02	11,5
F18 Warrior	150	00-02	13,5
Blog Ie	160	09-11	11,5
Centro Ie	160	08-09	11,5
PIAGGIO			
Free	100	02-03	7,3
Vespa Lx Primavera 4T 3V Ie	125	13-15	19,2
Vespa Sprint 4T 3V Ie	125	14-15	19,2
SUZUKI			
Burgman K2-K6	125	02-06	13
Burgman K7-L1	125	07-11	13
Uc Epicuro X - K1	125	99-01	14
Burgman K2-K6	150	02-06	16,5
Epicuro	150	99-01	13
Ux Sixteen K8 - L0	150	08-10	14
Ux Sixteen L1	150	11	14



KIT RULLI PULEGGIA MOTRICE

DRIVING PULLEY ROLLER SETS

MM 20 x 17

GRAMMATURE DISPONIBILI - WEIGHTS				
CODICE	•	•	BARCODE	N° Gr.
10 040 0020				6 8,5
10 040 0030				6 9,5
10 040 0470				6 10
10 040 0150				6 15

MODELLO - MODELS	CC	ANNO YEAR	Gr.
APRILIA			
Leonardo (I Serie)	125	99-01	8,5
Leonardo	150	99-01	9,5
Scarabeo Mot Rotax	200	99-03	10
GILERA			
Runner Fx-Fxr	180	97-02	15

MODELLO - MODELS	CC	ANNO YEAR	Gr.
ITALJET			
Dragster	180	99-03	15
PIAGGIO			
Hexagon Lx-Lxt	180	98-99	15
SUZUKI			
Sixteen	125	08-11	10
Sixteen	150	08-11	10

MM 21 x 17

GRAMMATURE DISPONIBILI - WEIGHTS				
CODICE	•	•	BARCODE	N° Gr.
10 040 0310		•		6 9
10 040 0320				6 10,3
10 040 0322 (832698)	•			6 10,7
10 040 0330		•		6 11
10 040 0672 (842870)	•			6 11,2
10 040 0842 (849480)	•			6 13,3

MODELLO - MODELS	CC	ANNO YEAR	Gr.
DERBI			
Gp1	250	06-07	11,2
Rambla	250	08-09	13,8
Rambla	300	10-12	13,8
GILERA			
Runner Vx-Vxr	200	02-04	10,7
Runner Vxr	200	05-11	10,7
Nexus Eu3	250	07	11,2
Nexus Eu3	250	06	13,8
Oregon	250	06-08	11,2
Nexus Eu3	300	08-12	11,2
PIAGGIO			
Beverly	125	01-03	10,7
Beverly Rst 4T 4V Eu3	125	10-12	11,2
Beverly Tourer Eu3	125	08-10	11,2
Carnaby	125	07-10	11,2
Mp3 Ibrido	125	09-10	11,2
Mp3 le Touring	125	11	11,2
Mp3 Yourban ERL	125	11-12	11,2
Vespa Granturismo	125	03-05	10,7
Vespa Gts 4T	125	07-11	11,2
X Evo	125	07-12	11,2
X7 Evo le Eu3	125	09-10	11,2
X10 4T 4V le Eu3	125	12	11,2
Hexagon Gtx	180	00	10,7
X9 Amalfi	180	00-03	10,7
Beverly	200	01-03	10,7
Carnaby	200	07-08	10,7

MODELLO - MODELS	CC	ANNO YEAR	Gr.
Liberty	200	06	10,7
Liberty 4T Eu3	200	07-08	10,7
Vespa Granturismo	200	03-07	10,7
X8	200	05-07	10,7
X9	200	02-03	10,7
Beverly	250	06-07	11,2
Beverly Tourer Eu3	250	08-09	13,8
Carnaby	250	08	13,8
Mp3	250	06-08	11,2
Vespa Gts- Abs	250	05-11	11,2
Vespa Gtv	250	06-09	11,2
X7 Eu3	250	08	11,2
X8 Eu3	250	05-08	11,2
X9 Evolution	250	04-06	11,2
Beverly 300 le Tourer	300	09-12	13,8
Carnaby Cruiser	300	09-11	13,8
Mp3 4T-Lt-Ibrido-Yourban	300	10-12	13,8
Mp3 Yourban ERL	300	11-15	13,3
Mp3 Lt Business - Sport Abs	300	14	13,3
Vespa Gts Super	300	08-12	13,8
Vespa Gts le & Touring	300	12-15	13,3
Vespa Gts Super Sport	300	10-13	13,3
Vespa Gtv 4T 4V ie	300	10-13	13,3
X7 Evo le Eu3	300	09-10	13,8

MODELLO - MODELS	CC	ANNO YEAR	Gr.
APRILIA			
Atlantic	125	03-05	11,2
Scarabeo	125	04-06	11,2
Scarabeo Light	125	09-11	11,2
Sport City Cube	125	08-10	11,2
Sr Max	125	11-12	11,2
Sport City	200	04-06	10,7
Sport City Cube	250	06-08	10,7
Sport City Cube	250	08-10	11,2
Sr Max	300	11-12	11,2

MM 23 x 18

GRAMMATURE DISPONIBILI - WEIGHTS				
CODICE	•	•	BARCODE	N° Gr.
10 040 0520		•		6 14
10 040 0050				6 15,5
10 040 0060				6 16
10 040 0942 (R.O. 122124)	•			6 17,5
10 040 0700				6 18
10 040 0530				6 19
10 040 0540				6 20
10 040 0580				3 20,8 3
10 040 0550		•		6 23
10 040 0560				6 24
10 040 0570				6 25
10 040 0080				6 27

MODELLO - MODELS	CC	ANNO YEAR	Gr.
HONDA			
Pantheon 2T	125	98-02	15,5
Pantheon 2T	150	98-02	16
Foresight	250		27
Foresight	250	98	25
Jazz	250	00-04	20,8+ 20,15
Sh I	300	07-12	19

MODELLO - MODELS	CC	ANNO YEAR	Gr.
KYMCO			
B&W	250	00	20
B&W Eu2	250	03	20
Grand Dink	250	01-02	20
People S	250	06	20
People S 250I	250	07	20
X Citing	250	05	20
Yup	250	03	20
Gran Dink	300	12	20
People S I	300	08	17,5
X Citing I	300	08-09	17,5
X Citing I R	300	08	17,5
PIAGGIO			
X9	250	00-01	24



MM 24 x 18

GRAMMATURE DISPONIBILI - WEIGHTS				
CODICE	●	●	BARCODE	N° Gr.
10 040 0892 (21650-14F60-000)	●	●		6 21
10 040 0070				6 23
10 040 0680		●		6 25
10 040 0180				6 31

MODELLO - MODELS	CC	ANNO YEAR	Gr.
HONDA			
Cn 4T	250		23
PIAGGIO			
Hexagon Gt-Gtx	250	98-00	23
SUZUKI			
Uh Burgman K7-L0	200	07-10	21
Uh Burgman L1	200	11-12	21
Uh Burgman L3	200	13	21
Burgman W-K2	250	98-02	31
Burgman K3-K6	250	03-06	31

MM 25 x 15

GRAMMATURE DISPONIBILI - WEIGHTS				
CODICE	●	●	BARCODE	N° Gr.
10 040 0660				8 15
10 040 0872	●	●		8 16
10 040 0862	●	●		8 17
10 040 0832 (5RU176322000)	●			8 18
10 040 0922 (5RU176325000)	●			8 20

MODELLO - MODELS	CC	ANNO YEAR	Gr.
YAMAHA			
Majesty	400	04-08	15
Majesty Abs	400	07-08	15
Majesty Abs	400	09-12	18
Yp X-Max	400	13-14	17
Xp T-Max	500	04-11	18
Xp T-Max	500	01-03	20
Xp T-Max Abs	530	12-13	18

MM 25 x 17

GRAMMATURE DISPONIBILI - WEIGHTS				
CODICE	●	●	BARCODE	N° Gr.
10 040 0642 (849914)	●			8 18,6
10 040 0652 (830899)	●			8 21,4

MODELLO - MODELS	CC	ANNO YEAR	Gr.
APRILIA			
Atlantic Sprint	400	05-08	18,6
Scarabeo Light	400	06-08	18,6
Atlantic Sprint	500	05-08	21,4
Scarabeo Light	500	06-08	21,4
GILERA			
Fuoco	500	07-12	21,4
Nexus Eu3	500	06-09	21,4
Nexus Sp Eu3	500	06-07	21,4
PIAGGIO			
Beverly Eu3	400	06-07	18,6
Beverly Tourer Eu3	400	08-10	18,6
Mp3	400	07-11	18,6
X Evo	400	07-09	18,6
X8 Eu3	400	06-08	18,6
Beverly	500	05-06	21,4
Beverly Cruiser	500	07-12	21,4
Beverly Eu3	500	06-08	21,4
Mp3 Lt-Rt	500	11-12	21,4
Mp3 Lt Sport - Business	500	11-13	21,4
Mp3 RL Sport - Business	500	11-12	21,4
X9 Evolution-Abs	500	06-07	21,4
X10 4T 4V Ie Eu3	500	12-14	21,4

MM 25 x 20

GRAMMATURE DISPONIBILI - WEIGHTS				
CODICE	●	●	BARCODE	N° Gr.
10 040 0742				6 17

MODELLO - MODELS	CC	ANNO YEAR	Gr.
KYMCO			
X Citing I Abs	400	14-15	17
X citing I	400	13-15	17





KIT RULLI PULEGGIA MOTRICE

DRIVING PULLEY ROLLER SETS

MM 25 x 22

GRAMMATURE DISPONIBILI - WEIGHTS				
CODICE	•	•	BARCODE	N° Gr.
10 040 0630	•			6 26
10 040 0480				6 27,3
10 040 0490				6 28,5
10 040 0500				6 29

MODELLO - MODELS	CC	ANNO YEAR	Gr.
APRILIA			
Atlantic	500	01-04	28,5
Scarabeo	500	03-06	28,5
GILERA			
Nexus	500	03-05	27,3
PIAGGIO			
Beverly	500	02-04	27,3
X9	500	01-02	29
X9 Evolution	500	03-05	27,3

MM 26 x 13

GRAMMATURE DISPONIBILI - WEIGHTS				
CODICE	•	•	BARCODE	N° Gr.
10 040 0610				8 17,5
10 040 0620	•			8 19
10 040 0190				8 21

MODELLO - MODELS	CC	ANNO YEAR	Gr.
MALAGUTI			
Madison K	400	02	17,5
Madison K Rst	400	02-04	17,5
SUZUKI			
Burgman X-K2	400	99-02	21
Burgman K3-L2	400	03-12	19

MM 28 x 20

GRAMMATURE DISPONIBILI - WEIGHTS				
CODICE	•	•	BARCODE	N° Gr.
10 040 0590	•			8 26
10 040 0600				8 27

MODELLO - MODELS	CC	ANNO YEAR	Gr.
HONDA			
Silver Wing	600		27

MM 29 x 22

GRAMMATURE DISPONIBILI - WEIGHTS				
CODICE	•	•	BARCODE	N° Gr.
10 040 0732	•			6 33,5
10 040 0752	•	•		6 31

MODELLO - MODELS	CC	ANNO YEAR	Gr.
KYMCO			
X Citing	500	05	33,5
X Citing 500 R	500	09	33,5
X Citing 500I	500	06-08	33,5

MODELLO - MODELS	CC	ANNO YEAR	STANDARD	HIGH QUALITY	DIMENSIONI DIMENSIONS	PESO WEIGHT	PEZZI PCS
APRILIA							
Amico	50	94-95	10 041 0650	-	15 x 12	6,5	6
Amico	50	96-98	10 041 0650	-	15 x 12	6,5	6
Amico Lx-Sport	50	92-93	10 041 0650	-	15 x 12	6,5	6
Area 51	50	98-00	10 041 0650	-	15 x 12	6,5	6
Gulliver / Lc	50	95-98	10 041 0650	-	15 x 12	6,5	6
Habana Kat	50		10 043 0750	-	17x12	7,5	6
Mojito	50	04-08	10 045 0630	10 045 0642	19x15,5	6,4	6
Rally /Lc	50	95-03	10 041 0650	-	15 x 12	6,5	6
Scarabeo	50	93-97	10 041 0650	-	15 x 12	6,5	6
Scarabeo 4T 4V	50	10-12	10 045 0530	10 045 0532	19x15,5	5,3	6
Scarabeo 4T Net	50	09-'10	10 045 0530	10 045 0532	19x15,5	5,3	6
Scarabeo 4T Rst Eu3	50	06-09	10 045 0530	10 045 0532	19x15,5	5,3	6
Scarabeo I.E. (02 Di Tech)	50		10 041 0860	-	15x12	8,6	6
Scarabeo Quattro	50	09	10 045 0530	10 045 0532	19x15,5	5,3	6
Scarabeo Street	50	05-06	10 045 0750	10 045 0752	19x15,5	7,5	6
Scarabeo Street 2T Rst	50	06-09	10 045 0750	10 045 0752	19x15,5	7,5	6
Scarabeo 2T Eu2 Piaggio	50	10-12	10 045 0750	10 045 0752	19x15,5	7,5	6
Scarabeo 2t Net	50	09-10	10 045 0750	10 045 0752	19x15,5	7,5	6

KIT RULLI PULEGGIA MOTRICE

DRIVING PULLEY ROLLER SETS



MODELLO - MODELS	CC	ANNO YEAR	STANDARD	HIGH QUALITY	DIMENSIONI DIMENSIONS	PESO WEIGHT	PEZZI PCS
Sonic	50	98-07	10 041 0650	-	15 x 12	6,5	6
Sport City One 2T	50	08-11	10 045 0750	10 045 0752	19x15,5	7,5	6
Sport City One 4T	50	08-10	10 045 0630	10 045 0642	19x15,5	6,4	6
Sr (Cil.Orizz. Raff. Aria)	50		10 041 0520	-	15x12	5,2	6
Sr / Lc	50	94-96	10 041 0650	-	15 x 12	6,5	6
Sr Stealth, Racing	50	97-99	10 041 0650	-	15 x 12	6,5	6
Sr www	50	97-01	10 041 0650	-	15 x 12	6,5	6
Sr (Mod.00 Mot Suzuki)	50		10 043 0750	-	17x12	7,5	6
Sr Di Tech (Mod.01)	50		10 043 0750	-	17x12	7,5	6
Sr R Factory Carb.	50	10-12	10 045 0630	10 045 0642	19x15,5	5,3	6
Sr R Factory ie	50	10-12	10 045 0530	10 045 0532	19x15,5	5,3	6
Sr R R Factory (Iniezione)	50	04-09	10 045 0530	10 045 0532	19x15,5	5,3	6
Sr R R Factory Carburatore - <i>Carburetor</i>)	50	04-09	10 045 0630	10 045 0642	19x15,5	6,4	6
Sr Street (Carburatore - <i>Carburetor</i>)	50	03-08	10 045 0630	10 045 0642	19x15,5	6,4	6
Sr Street (Iniezione)	50	03-08	10 045 0530	10 045 0532	19x15,5	5,3	6
Scarabeo 4T	100	01-04	10 040 0420	-	20x15	7,3	6
Scarabeo 4T Rst	100	06-09	10 040 0420	-	20x15	7,3	6
Scarabeo 4T / Net	100	10-12	10 040 0420	-	20x15	7,3	6
Scarabeo Motori Minarelli	100	00	10 041 0750	-	15x12	7,5	6
Atlantic	125	03-05	-	10 040 0672	21x17	11,2	6
Atlantic Eu3	125	06-08	10 040 0250	10 040 0252	19x17	7,3	6
Leonardo (I Serie)	125	96-98	10 040 0010	-	18x15	10,7	6
Leonardo (I Serie)	125	99-01	10 040 0020	-	20x17	8,5	6
Mojito	125	03-08	10 040 0260	-	19x17	8	6
Mojito Retro' - Custom	125	99-01	10 040 0130	-	19x14	12	6
Scarabeo	125	04-06	-	10 040 0672	21x17	11,2	6
Scarabeo Light	125	07-09	10 040 0260	-	19x17	8	6
Scarabeo Light	125	09-11	-	10 040 0672	21x17	11,2	6
Sport City	125	04-06	10 040 0250	10 040 0252	19x17	7,3	6
Sport City Cube	125	08-10	10 040 0250	10 040 0252	19x17	7,3	6
Sport City Eu3	125	06-08	10 040 0250	10 040 0252	19x17	7,3	6
Sport City One	125	08	10 040 0260	-	19x17	8	6
Sr Motard	125	12	10 040 0260	-	19x17	8	6
Sr	125	99-01	10 040 0300	-	19x17	13	6
Sr Max	125	11-12	10 040 0250	10 040 0252	19x17	7,3	6
Leonardo	150	99-01	10 040 0030	-	20x17	9,5	6
Sr	150	99-01	10 040 0300	-	19x17	13	6
Scarabeo Mot Rotax	200	99-03	10 040 0470	-	20x17	10	6
Sport City	200	04-06	10 040 0320	10 040 0322	21x17	10,7	6
Sport City Cube	200	08	10 040 0320	10 040 0322	21x17	10,7	6
Sport City Eu3	200	06-08	10 040 0320	10 040 0322	21x17	10,7	6
Leonardo	250	99-04	10 040 0040	-	20x12	14	8
Leonardo St	250	01	10 040 0040	-	20x12	14	8
Sport City Cube	250	06-08	10 040 0320	10 040 0322	21x17	10,7	6
Sport City Cube	250	08-10	10 040 0250	10 040 0252	19x17	7,3	6
Sr Max	300	11-12	10 040 0250	10 040 0252	19x17	7,3	6
Atlantic Sprint	400	05-08	-	10 040 0642	25x17	18,6	8



KIT RULLI PULEGGIA MOTRICE

DRIVING PULLEY ROLLER SETS

MODELLO - MODELS	CC	ANNO YEAR	STANDARD	HIGH QUALITY	DIMENSIONI DIMENSIONS	PESO WEIGHT	PEZZI PCS
Scarabeo Light	400	06-08	-	10 040 0642	25x17	18,6	8
Atlantic	500	01-04	10 040 0490	-	25x22	28,5	6
Atlantic Sprint	500	05-08	-	10 040 0652	25x17	21,4	8
Scarabeo	500	03-06	10 040 0490	-	25x22	28,5	6
Scarabeo Light	500	06-08	-	10 040 0652	25x17	21,4	8
ATALA							
Carosello	50		10 041 0700	-	15x12	7	6
Hacker	50		10 043 0550	-	17x12	5,5	6
BENELLI							
491 Gt	50	98-99	10 041 0650	-	15x12	6,5	6
491 Rr	50	98-01	10 041 0550	-	15x12	5,5	6
491 St	50		10 041 0550	-	15x12	5,5	6
K2 Liquid Cooled	50	99-01	10 041 0650	-	15x12	6,5	6
Naked	50	02	10 041 0650	-	15x12	6,5	6
Pepe	50	99-01	10 041 0650	-	15x12	6,5	6
Sport Racing	50		10 041 0650	-	15x12	6,5	6
Adiva	125	01-02	10 040 0260	-	19x17	8	6
Velvet	125	99-01	10 040 0350	-	20x12	9	6
Velvet Touring	125	02-03	10 040 0350	-	20x12	9	6
Velvet	150	99-01	10 040 0360	-	20x12	9,6	6
Velvet Touring	150	02-03	10 040 0360	-	20x12	9,6	6
Velvet	250	99-01	10 040 0040	-	20x12	14	8
Velvet Touring	250	02-03	10 040 0040	-	20x12	14	8
BETA							
Ark Air	50	96-08	10 041 0550	-	15x12	5,5	6
Ark Lc	50	96-03	10 041 0550	-	15x12	5,5	6
Elkon	50	99-03	10 041 0680	-	15x12	6,8	6
Quadra Chrono 502	50	96-99	10 041 0550	-	15x12	5,5	6
Tempo	50	94-95	10 041 0700	-	15x12	7	6
CAGIVA							
City	50	91-94	10 041 0750	-	15x12	7,5	6
Progress	50	97-99	10 043 0600	-	17x12	6	6
DERBI							
Atlantis	50	99-01	10 043 0720	-	17x12	7,2	6
Atlantis 02 Bullet	50	03-05	10 045 0630	10 045 0642	19x15,5	6,4	6
Atlantis 02 City	50	03-06	10 045 0630	10 045 0642	19x15,5	6,4	6
Atlantis 02 Red Bullet	50	03	10 045 0630	10 045 0642	19x15,5	6,4	6
Atlantis 02 Two Chic	50	05	10 045 0630	10 045 0642	19x15,5	6,4	6
Atlantis 2T Eu2	50	07-10	10 045 0630	10 045 0642	19x15,5	6,4	6
Atlantis 4T Eu2	50	07	10 045 0630	10 045 0642	19x15,5	6,4	6
Atlantis 50 4T	50	04-06	10 045 0630	10 045 0642	19x15,5	6,4	6
Atlantis Kat (Raffreddato Aria)	50		10 043 0580	-	17x12	5,8	6
Atlantis Lc	50	99-01	10 043 0720	-	17x12	7,2	6
Gp1	50	01-03	10 045 0530	10 045 0532	19x15,5	5,3	6
Gp1 Eu2	50	05	10 045 0530	10 045 0532	19x15,5	5,3	6
Gp1 Open Eu2	50	06-09	10 045 0630	10 045 0642	19x15,5	6,4	6
Gp1 Race Eu2	50	05-07	10 045 0630	10 045 0642	19x15,5	6,4	6

KIT RULLI PULEGGIA MOTRICE

DRIVING PULLEY ROLLER SETS



MODELLO - MODELS	CC	ANNO YEAR	STANDARD	HIGH QUALITY	DIMENSIONI DIMENSIONS	PESO WEIGHT	PEZZI PCS
Hunter	50	96-97	10 043 0630	-	17x12	6,3	6
Paddock Lc	50	98-01	10 043 0600	-	17x12	6	6
Predator Lc	50	98-01	10 043 0720	-	17x12	7,2	6
Boulevard	125	02-04	-	10 040 0692	19x17	8,6	6
Boulevard Eu3	125	04-07	-	10 040 0692	19x17	8,6	6
Boulevard 4T Eu3	125	08-12	10 040 0260	-	19x17	8	6
Sonar 4T	125	09-12	-	10 040 0692	19x17	8,6	6
Variant Sport 4T Eu3	125	12	-	10 040 0692	19x17	8,6	6
Gp1 Eu2	125	06	10 040 0250	10 040 0252	19x17	7,3	6
Gp1 Low Seat 125 Eu3	125	07-08	10 040 0250	10 040 0252	19x17	7,3	6
Rambla	125	08	10 040 0250	10 040 0252	19x17	7,3	6
Boulevard	150	02-04	10 040 0270	10 040 0272	19x17	10	6
Boulevard Eu3	150	04-07	10 040 0270	10 040 0272	19x17	10	6
Gp1	250	06-07	-	10 040 0672	21x17	11,2	6
Gp1 Low Seat 250 Eu3	250	07-08	-	10 040 0672	21x17	11,2	6
Rambla	250	08-09	-	10 040 0842	21x17	13,8	6
Rambla	300	10-12	-	10 040 0842	21x17	13,8	6
GILERA							
Dna	50	05-07	10 045 0630	10 045 0642	19x15,5	6,4	6
Dna	50	00-02	10 045 0750	10 045 0752	19x15,5	7,5	6
Dna Gp Experience	50	03-04	10 045 0630	10 045 0642	19x15,5	6,4	6
Easy Moving	50	95-96	10 042 0850	-	16x13	8,5	6
Ice	50	01-05	10 045 0750	10 045 0752	19x15,5	7,5	6
Runner	50	97-00	10 045 0530	10 045 0532	19x15,5	5,3	6
Runner Poggiali	50	02	10 045 0750	10 045 0752	19x15,5	7,5	6
Runner Purejet	50	02-07	10 045 0530	10 045 0532	19x15,5	5,3	6
Runner Purejet St	50	08-11	10 045 0530	10 045 0532	19x15,5	5,3	6
Runner Sp	50	05-07	10 045 0630	10 045 0642	19x15,5	6,4	6
Runner Sp	50	02-04	10 045 0750	10 045 0752	19x15,5	7,5	6
Runner Sp	50	10-12	10 045 0630	10 045 0642	19x15,5	6,4	6
Runner Sp Special Edition	50	07	10 045 0630	10 045 0642	19x15,5	6,4	6
Runner Sp St & Simoncelli	50	08-09	10 045 0630	10 045 0642	19x15,5	6,4	6
Stalker	50	97-11	10 045 0750	10 045 0752	19x15,5	7,5	6
Stalker Naked	50	08	10 045 0750	10 045 0752	19x15,5	7,5	6
Stalker Special Edition	50	07-08	10 045 0750	10 045 0752	19x15,5	7,5	6
Storm	50	94-95	10 042 0850	-	16x13	8,5	6
Storm Eu2	50	07	10 045 0630	10 045 0642	19x15,5	6,4	6
Typhoon	50	94-97	10 042 0850	-	16x13	8,5	6
Typhoon X	50	98-99	10 042 0850	-	16x13	8,5	6
Typhoon Xr	50	00	10 045 0630	10 045 0642	19x15,5	6,4	6
Dna	125	01	10 040 0250	10 040 0252	19x17	7,3	6
Nexus Eu3 ie	125	08-09	10 040 0250	10 040 0252	19x17	7,3	6
Runner Fx-Fxr	125	97-02	10 040 0140	-	19x17	15	6
Runner Vx	125	05-06	10 040 0250	10 040 0252	19x17	7,3	6
Runner Vx 4T Eu3	125	07	10 040 0250	10 040 0252	19x17	7,3	6
Runner Vx 4T St Eu3	125	08-09	10 040 0250	10 040 0252	19x17	7,3	6
Runner Vx Race	125	06	10 040 0250	10 040 0252	19x17	7,3	6



KIT RULLI PULEGGIA MOTRICE

DRIVING PULLEY ROLLER SETS

MODELLO - MODELS	CC	ANNO YEAR	STANDARD	HIGH QUALITY	DIMENSIONI DIMENSIONS	PESO WEIGHT	PEZZI PCS
Runner Vx Sc	125	06-07	10 040 0250	10 040 0252	19x17	7,3	6
Runner Vx Vxr	125	00-01	10 040 0250	10 040 0252	19x17	7,3	6
Runner Vx-Vxr	125	02-04	10 040 0250	10 040 0252	19x17	7,3	6
Typhoon	125	95-98	10 040 0300	-	19x17	13	6
Typhoon X-Xr	125	99-00	10 040 0300	-	19x17	13	6
Runner Fx-Fxr	180	97-02	10 040 0150	-	20x17	15	6
Runner Vx-Vxr	200	02-04	10 040 0320	10 040 0322	21x17	10,7	6
Runner Vxr	200	05-06	10 040 0320	10 040 0322	21x17	10,7	6
Runner Vxr 4T St Eu3	200	08-11	10 040 0320	10 040 0322	21x17	10,7	6
Runner Vxr Eu3	200	07	10 040 0320	10 040 0322	21x17	10,7	6
Runner Vxr Race	200	06	10 040 0320	10 040 0322	21x17	10,7	6
Nexus Eu3	250	07	-	10 040 0672	21x17	11,2	6
Nexus Eu3	250	06	10 040 0250	10 040 0252	19x17	7,3	6
Nexus Sp Eu3	250	06-07	10 040 0250	10 040 0252	19x17	7,3	6
Oregon	250	06-08	-	10 040 0672	21x17	11,2	6
Nexus Eu3	300	08-12	10 040 0250	10 040 0252	19x17	7,3	6
Fuoco	500	07-12	-	10 040 0652	25x17	21,4	8
Nexus	500	03-05	10 040 0480	-	25x22	27,3	6
Nexus Eu3	500	06-12	-	10 040 0652	25x17	21,4	8
Nexus Sp Eu3	500	06-07	-	10 040 0652	25x17	21,4	8
HONDA							
Gp Dio	50	91	10 042 0850	-	16x13	8,5	6
Sfx V	50	95	10 042 0900	-	16x13	9	6
Sh	50	96	10 042 0900	-	16x13	9	6
Shadow	50		10 042 0900	-	16x13	9	6
Sj Bali	50	93	10 042 0850	-	16x13	8,5	6
Sky	50	97	10 042 0500	-	16x13	5	6
Vision Met-In	50		10 042 0850	-	16x13	8,5	6
Vision Prima Serie	50	85-87	10 042 0750	-	16x13	7,5	6
Nps Zoomer	50		10 042 0550	-	16x13	5,5	6
Sh	100	96-99	10 042 1000	-	16x13	10	6
Sj Bali	100	96-99	10 042 1000	-	16x13	10	6
Nsc Vision	110		10 040 0100	-	18x14	14,5	6
Chiocciola	125	00-06	10 040 0430	-	20x15	11,5	6
Dylan	125	01-06	10 040 0430	-	20x15	11,5	6
Nes	125	00-07	10 040 0440	-	20x15	12,5	6
Pantheon 2T	125	98-02	10 040 0050	-	23x18	15,5	6
Pantheon	125	03-05	10 040 0440	-	20x15	12,5	6
Sh 125 – 125i	125	01-12	10 040 0430	-	20x15	11,5	6
Pcx	125	10-13	10 040 0460	-	20x15	16,5	6
Ps	125	06-10	10 040 0430	-	20x15	11,5	6
Chiocciola	150	00-06	10 040 0440	-	20x15	12,5	6
Dylan	150	01-06	10 040 0440	-	20x15	12,5	6
Nes	150	00-07	10 040 0440	-	20x15	12,5	6
Pantheon 2T	150	98-02	10 040 0060	-	23x18	16	6
Sh 150 – 150i	150	01-08	10 040 0440	-	20x15	12,5	6
Ps	150	06-10	10 040 0440	-	20x15	12,5	6

KIT RULLI PULEGGIA MOTRICE
DRIVING PULLEY ROLLER SETS



MODELLO - MODELS	CC	ANNO YEAR	STANDARD	HIGH QUALITY	DIMENSIONI DIMENSIONS	PESO WEIGHT	PEZZI PCS
Pcx	150	10-14	10 040 0962	-	20x15	18	6
Cn 4T	250		10 040 0070	-	24x18	23	6
Foresight	250		10 040 0080	-	23x18	27	6
Foresight	250	98	10 040 0570	-	23x18	25	6
Jazz	250	00-04	10 040 0580	-	23x18	29,8+20,15	6
Sh i	300	07-12	10 040 0530	-	23x18	19	6
Silver Wing	600		10 040 0600	-	28x20	27	8
ITALJET							
Bazooka	50		10 041 0650	-	15x12	6,5	6
Formula Lc	50	97	10 043 0550	-	17x12	5,5	6
Pista	50		10 041 0650	-	15x12	6,5	6
Reporter	50		10 041 0650	-	15x12	6,5	6
Dragster	125	99-03	10 040 0140	-	19x17	14,5	6
Jet Set 4T	125		10 040 0260	-	19x17	8	6
Jupiter 4T	125		10 040 0350	-	20x12	9	6
Millennium	125		10 040 0350	-	20x12	9	6
Torpedo	125	98-00	10 040 0130	-	19x14	12	6
Torpedo (Mot Leader)	125	00-03	10 040 0260	-	19x17	8	6
Jet Set 4T	150		10 040 0360	-	20x12	9,6	6
Millennium	150		10 040 0360	-	20x12	9,6	6
Dragster	180	99-03	10 040 0150	-	20x17	15	6
Millennium	180		10 041 0750	-	15x12	7,5	6
KYMCO							
Agility 2T R16	50	10-12	10 042 0850	-	16x13	8,5	6
Agility 4T Carry	50	11-12	10 042 0650	-	16x13	6,5	6
Agility 4T R10	50	06	10 042 0650	-	16x13	6,5	6
Agility 4T R12	50	07-08	10 042 0650	-	16x13	6,5	6
Agility 4T R16	50	08-12	10 042 0650	-	16x13	6,5	6
Agility Plus 2T	50	14	10 042 0850	-	16x13	8,5	6
Agility R12	50	05	10 042 0650	-	16x13	6,5	6
Agility Rs	50	09	10 042 0650	-	16x13	6,5	6
Agility RS Naked 2T	50	10	10 042 0850	-	16x13	8,5	6
B&w	50	02	10 042 0850	-	16x13	8,5	6
B&w Eu2	50	03	10 042 0850	-	16x13	8,5	6
Cx	50	93	10 042 0850	-	16x13	8,5	6
Cx Super	50	94-97	10 042 0850	-	16x13	8,5	6
Dink 50 4T	50	07	10 042 0650	-	16x13	6,5	6
Dink Classic Eu2	50	03	10 042 0850	-	16x13	8,5	6
Dink Lc	50	98-02	10 042 0850	-	16x13	8,5	6
Dj W	50	94-00	10 042 0850	-	16x13	8,5	6
Dj X	50	91-92	10 042 0850	-	16x13	8,5	6
Djy	50	93	10 042 0850	-	16x13	8,5	6
Fever Zx	50	99-00	10 042 0850	-	16x13	8,5	6
Fever Zx Eu2	50	03-04	10 042 0750	-	16x13	7,5	6
Heroism	50	95-97	10 042 0750	-	16x13	7,5	6
K12	50	95-00	10 042 0850	-	16x13	8,5	6
Kb	50	95-00	10 042 0850	-	16x13	8,5	6



KIT RULLI PULEGGIA MOTRICE

DRIVING PULLEY ROLLER SETS

MODELLO - MODELS	CC	ANNO YEAR	STANDARD	HIGH QUALITY	DIMENSIONI DIMENSIONS	PESO WEIGHT	PEZZI PCS
Like 2T	50	09	10 042 0850	-	16x13	8,5	6
Like 4T	50	09	10 042 0650	-	16x13	6,5	6
Mxer	50	02-03	10 042 0750	-	16x13	7,5	6
People	50	04	10 042 0850	-	16x13	8,5	6
People	50	99-00	10 042 0850	-	16x13	8,5	6
People Eu2	50	03	10 042 0850	-	16x13	8,5	6
People Eu2	50	08-11	10 042 0850	-	16x13	8,5	6
People S	50	05-08	10 042 0850	-	16x13	8,5	6
People S 4T	50	06-08	10 042 0650	-	16x13	6,5	6
Sento	50	08	10 042 0650	-	16x13	6,5	6
Sniper	50	93	10 042 0750	-	16x13	7,5	6
Sniper Dd	50	94-96	10 042 0750	-	16x13	7,5	6
Super 8	50	07	10 042 0650	-	16x13	6,5	6
Super 8 2T	50	09	10 042 0850	-	16x13	8,5	6
Super 8 2T	50	13	10 042 0850	-	16x13	8,5	6
Super 8 4T	50	09	10 042 0650	-	16x13	6,5	6
Super 9	50	00	10 042 0850	-	16x13	8,5	6
Super 9 Sport Eu2	50	03-04	10 042 0850	-	16x13	8,5	6
Top Boy	50	97-00	10 042 0850	-	16x13	8,5	6
Vitality 2T	50	04	10 042 0850	-	16x13	8,5	6
Vitality 4T	50	04	10 042 0650	-	16x13	6,5	6
Yup	50	02	10 042 0850	-	16x13	8,5	6
Yup Eu2	50	03	10 042 0850	-	16x13	8,5	6
Agility 4T	125	06	10 040 0230	-	18x14	13,5	6
Agility 4T Eu3	125	06-08	10 040 0230	-	18x14	13,5	6
Agility Carry	125	11-12	10 040 0230	-	18x14	13,5	6
Agility Plus	125	14	10 040 0090	10 040 0092	18x14	13	6
Agility R16	125	09-12	10 040 0090	10 040 0092	18x14	13	6
Agility Rs	125	09	10 040 0230	-	18x14	13,5	6
B&w	125	00	10 040 0110	-	20x15	13,5	6
Dink	125	97-98	10 040 0110	-	20x15	13,5	6
Dink Classic	125	02	10 040 0110	-	20x15	13,5	6
Dink Classic Eu2	125	03	10 040 0110	-	20x15	13,5	6
Dink Lx	125	98-00	10 040 0110	-	20x15	13,5	6
Downtown 125 i	125	09	10 040 0090	10 040 0092	18x14	13	6
Grand Dink	125	01-02	10 040 0110	-	20x15	13,5	6
Grand Dink Eu2	125	03-04	10 040 0110	-	20x15	13,5	6
Heroism	125	95-97	10 040 0090	10 040 0092	18x14	13	6
K-Xct i	125	12-14	10 040 0090	10 040 0092	18x14	13	6
Like	125	09	10 040 0230	-	18x14	13,5	6
Like Lx	125	12	10 040 0230	-	18x14	13,5	6
Movie	125	99-00	10 040 0090	10 040 0092	18x14	13	6
Movie 125 Eu3	125	06-07	10 040 0230	-	18x14	13,5	6
Movie XL	125	01	10 040 0230	-	18x14	13,5	6
Movie XL Eu2	125	03-04	10 040 0230	-	18x14	13,5	6
People	125	99-00	10 040 0090	10 040 0092	18x14	13	6
People Eu2	125	03	10 040 0090	10 040 0092	18x14	13	6

KIT RULLI PULEGGIA MOTRICE
DRIVING PULLEY ROLLER SETS



MODELLO - MODELS	CC	ANNO YEAR	STANDARD	HIGH QUALITY	DIMENSIONI DIMENSIONS	PESO WEIGHT	PEZZI PCS
People Eu3	125	07-11	10 040 0090	10 040 0092	18x14	13	6
People Gti	125	10	10 040 0090	10 040 0092	18x14	13	6
People One i	125	13-14	10 040 0230	-	18x14	13,5	6
People S	125	05	10 040 0090	10 040 0092	18x14	13	6
People S Dd Eu3	125	07-08	10 040 0090	10 040 0092	18x14	13	6
Super 8	125	08-09	10 040 0090	10 040 0092	18x14	13	6
Vivio	125	00	10 040 0090	10 040 0092	18x14	13	6
Agility R16	150	08-09	10 040 0090	10 040 0092	18x14	13	6
B&w	150	97-00	10 040 0120	-	20x15	14,5	6
B&w Eu2	150	03-04	10 040 0120	-	20x15	14,5	6
Dink Classic	150	02	10 040 0120	-	20x15	14,5	6
Dink Classic Eu2	150	03	10 040 0120	-	20x15	14,5	6
Dink Lx	150	98-00	10 040 0120	-	20x15	14,5	6
Grand Dink Eu2	150	01-02	10 040 0460	-	20x15	16,5	6
Grand Dink Eu2	150	03-04	10 040 0460	-	20x15	16,5	6
Heroism	150	95-97	10 040 0100	-	18x14	14,5	6
Movie 150 Eu3	150	06-07	10 040 0240	-	18x14	15,5	6
Movie XL	150	01	10 040 0240	-	18x14	15,5	6
Movie XL Eu2	150	03-04	10 040 0240	-	18x14	15,5	6
People	150	99-00	10 040 0100	-	18x14	14,5	6
People 0 Eu2	150	03	10 040 0100	-	18x14	14,5	6
Vivio	150	00	10 040 0100	-	18x14	14,5	6
Agility 200 R16	200	10-12	10 040 0230	-	18x14	13,5	6
Agility i Plus	200	14	10 040 0090	10 040 0092	18x14	13	6
Agility Plus	200	14	10 040 0230	-	18x14	13,5	6
Dink Classic	200	04	10 040 0460	-	20x15	16,5	6
Like 200I	200	09	10 040 0230	-	18x14	13,5	6
Like Lx	200	12	10 040 0230	-	18x14	13,5	6
People S	200	05	10 040 0090	10 040 0092	18x14	13	6
People S i	200	07	10 040 0090	10 040 0092	18x14	13	6
B&w	250	00	10 040 0540	-	23x18	20	6
B&w Eu2	250	03	10 040 0540	-	23x18	20	6
Grand Dink	250	01-02	10 040 0540	-	23x18	20	6
Grand Dink Eu2	250	03-04	10 040 0540	-	23x18	20	6
People Lc	250	03-04	10 040 0540	-	23x18	20	6
People S	250	06	10 040 0540	-	23x18	20	6
People S 250i	250	07	10 040 0540	-	23x18	20	6
X Citing	250	05	10 040 0540	-	23x18	20	6
X Citing i	250	06-07	10 040 0540	-	23x18	20	6
Yup	250	03	10 040 0540	-	23x18	20	6
Downtown Abs i	300	10-12	10 040 0410	-	20x12	15,3	8
Downtown-Downtown i	300	09-11	10 040 0410	-	20x12	15,3	8
Gran Dink	300	12	10 040 0540	-	23x18	20	6
K-Xct i	300	12	10 040 0410	-	20x12	15,3	8
K-Xct i Abs	300	14	10 040 0410	-	20x12	15,3	8
People Gti	300	11-14	10 040 0410	-	20x12	15,3	8
People Gti Abs	300	12-14	10 040 0410	-	20x12	15,3	8



KIT RULLI PULEGGIA MOTRICE

DRIVING PULLEY ROLLER SETS

MODELLO - MODELS	CC	ANNO YEAR	STANDARD	HIGH QUALITY	DIMENSIONI DIMENSIONS	PESO WEIGHT	PEZZI PCS
People S i	300	08	-	10 040 0942	23x17,5	17,5	6
X Citing i	300	08	-	10 040 0942	23x17,5	17,5	6
X Citing i R	300	08-09	-	10 040 0942	23x17,5	17,5	6
X Citing i	400	13-15	-	10 040 0742	25x20	17	6
X Citing i ABS	400	13-15	-	10 040 0742	25x20	17	6
X Citing	500	05	-	10 040 0732	29x22	33,5	6
X Citing 500 R	500	09	-	10 040 0732	29x22	33,5	6
X Citing 500i	500	06-08	-	10 040 0732	29x22	33,5	6
X Citing 500i R	500	07-08	-	10 040 0732	29x22	33,5	6
MALAGUTI							
Centro Base	50	93-94	10 041 0700	-	15x12	7	6
Centro SL	50	94-98	10 041 0700	-	15x12	7	6
Centro SL Kat	50	99-00	10 041 0700	-	15x12	7	6
Crosser Cr1	50	95-98	10 041 0550	-	15x12	5,5	6
F10 Jet Line	50	92-98	10 041 0650	-	15x12	6,5	6
F10 Kat	50	99-00	10 041 0650	-	15x12	6,5	6
F10 Rst Eu1	50	01-02	10 041 0650	-	15x12	6,5	6
F10 Rst Eu2	50	02-06	10 041 0650	-	15x12	6,5	6
F12 Aria Rst Eu2	50	06	10 041 0650	-	15x12	6,5	6
F12 Phantom	50	94-98	10 041 0650	-	15x12	6,5	6
F12 Phantom Eu1	50	99-00	10 041 0650	-	15x12	6,5	6
F12 Phantom Lc	50	94-98	10 041 0650	-	15x12	6,5	6
F12 Phantom Lc Rst Eu1	50	01-02	10 041 0650	-	15x12	6,5	6
F12 Phantom Lc Rst Eu2	50	02	10 041 0650	-	15x12	6,5	6
F15 Fire Fox Air Cooled	50	05-06	10 041 0650	-	15x12	6,5	6
Yesterday - Euro	50	97-00	10 041 0650	-	15x12	6,5	6
Ciak	100	99-00	10 043 0660	-	17x12	6,6	6
Blog ie	125	09-11	10 040 0430	-	20x15	11,5	6
Centro ie	125	08-09	10 040 0430	-	20x15	11,5	6
Centro SL ie	125	09-11	10 040 0430	-	20x15	11,5	6
Ciak	125	00-01	10 040 0090	10 040 0092	18x14	13	6
Ciak Master	125	04	10 040 0090	10 040 0092	18x14	13	6
Ciak Master Eu3	125	06	10 040 0090	10 040 0092	18x14	13	6
Ciak Rst Eu2	125	03	10 040 0090	10 040 0092	18x14	13	6
F18 Warrior	125	00-02	10 040 0430	-	20x15	11,5	6
Madison	125	99-01	10 040 0340	-	20x12	8,5	6
Madison R Rst	125	02	10 040 0340	-	20x12	8,5	6
Madison R Rst Eu2	125	03-04	10 040 0360	-	20x12	9,6	6
Phantom Max	125	03	10 040 0360	-	20x12	9,6	6
Ciak	150	00-02	10 040 0100	-	18x14	14,5	6
Ciak Master	150	04	10 040 0100	-	18x14	14,5	6
Ciak Rst Eu2	150	03	10 040 0100	-	18x14	14,5	6
F18 Warrior	150	00-02	10 040 0110	-	20x15	13,5	6
Madison T	150	99-01	10 040 0360	-	20x12	9,6	6
Blog ie	160	09-11	10 040 0430	-	20x15	11,5	6
Centro ie	160	08-09	10 040 0430	-	20x15	11,5	6
Ciak Master Eu2	200	06	10 040 0090	10 040 0092	18x14	13	6

KIT RULLI PULEGGIA MOTRICE

DRIVING PULLEY ROLLER SETS



MODELLO - MODELS	CC	ANNO YEAR	STANDARD	HIGH QUALITY	DIMENSIONI DIMENSIONS	PESO WEIGHT	PEZZI PCS
Madison S	250	99-01	10 040 0400	-	20x12	13,5	8
Madison K	400	02	10 040 0610	-	26x13	17,5	8
Madison K Rst	400	02-04	10 040 0610	-	26x13	17,5	8
MBK							
Booster	50	01-02	10 041 0620	-	15x12	6,2	6
Booster	50	92-94	10 041 0650	-	15x12	6,5	6
Booster Naked	50	03	10 041 0620	-	15x12	6,2	6
Booster Ng	50	01-03	10 041 0620	-	15x12	6,2	6
Booster Ng	50	95-98	10 041 0700	-	15x12	7	6
Booster Ng	50	99	10 041 0650	-	15x12	6,5	6
Booster Ng Eu1	50	99-00	10 041 0650	-	15x12	6,5	6
Booster Road (Ita)	50	94-95	10 041 0650	-	15x12	6,5	6
Booster Spirit	50	03	10 041 0620	-	15x12	6,2	6
Booster Spirit	50	96-98	10 041 0700	-	15x12	7	6
Booster Spirit	50	99-00	10 041 0650	-	15x12	6,5	6
Booster Spirit Eu2	50	02	10 041 0620	-	15x12	6,2	6
Booster Spirit Eu2	50	02-03	10 041 0620	-	15x12	6,2	6
Booster Track	50	96-98	10 041 0700	-	15x12	7	6
Evolis	50	94-95	10 041 0700	-	15x12	7	6
Fizz	50	94-95	10 041 0700	-	15x12	7	6
Flipper	50	98-02	10 041 0650	-	15x12	6,5	6
Flipper Catalitico	50	99-00	10 041 0650	-	15x12	6,5	6
Flipper Eu2	50	03-04	10 041 0650	-	15x12	6,5	6
Forte (Che-Ita)	50	94-96	10 041 0650	-	15x12	6,5	6
Mach G Eu1	50	02-03	10 041 0650	-	15x12	6,5	6
Mach G Eu2	50	02-04	10 041 0650	-	15x12	6,5	6
Nitro	50	97-04	10 041 0550	-	15x12	5,5	6
Nitro Eu2	50	03	10 041 0550	-	15x12	5,5	6
Nitro Jaguar	50	04	10 041 0550	-	15x12	5,5	6
Ovetto (Che-Ita)	50	97-01	10 041 0650	-	15x12	6,5	6
Ovetto Eu1	50	02-04	10 041 0650	-	15x12	6,5	6
Ovetto Eu2	50	02-03	10 041 0650	-	15x12	6,5	6
Sorriso	50	91-92	10 041 0650	-	15x12	6,5	6
Sorriso	50	93-95	10 041 0650	-	15x12	6,5	6
Stunt	50	00-02	10 041 0620	-	15x12	6,2	6
Booster	100	99-01	10 041 0830	-	15x12	8,3	6
Nitro	100	00-02	10 041 0900	-	15x12	9	6
Ovetto	100	00-02	10 041 0900	-	15x12	9	6
Dodo	125	01-02	10 040 0370	-	20x12	10,5	6
Flame – R	125	95-99	10 040 0390	-	20x12	12	6
Flame F	125	00	10 040 0370	-	20x12	10,5	6
Flame R	125	96-99	10 040 0370	-	20x12	10,5	6
Skyliner	125	98-02	10 040 0340	-	20x12	8,5	6
Skyliner	125	01-02	10 040 0370	-	20x12	10,5	6
Thunder	125	01-02	10 040 0370	-	20x12	10,5	6
Thunder	150	01-02	10 040 0370	-	20x12	10,5	6
Skyliner	150	01-02	10 040 0370	-	20x12	10,5	6



KIT RULLI PULEGGIA MOTRICE

DRIVING PULLEY ROLLER SETS

MODELLO - MODELS	CC	ANNO YEAR	STANDARD	HIGH QUALITY	DIMENSIONI DIMENSIONS	PESO WEIGHT	PEZZI PCS
Skyliner	180	03	10 040 0410	-	20x12	15,3	8
Skyliner	250	00-03	10 040 0390	-	20x12	11,5	8
Skyliner Abs	250	03	10 040 0390	-	20x12	11,5	8
Kilibre	300	03	10 040 0410	-	20x12	15,3	8
PEUGEOT							
Buxy	50	94-97	10 042 0900	-	16x13	9	6
Elyseo	50	99	10 042 0900	-	16x13	9	6
Looxor	50	01-03	10 042 0900	-	16x13	9	6
Metal-X	50	02	10 042 0900	-	16x13	9	6
Speedake (Keihin)	50	95-97	10 042 0750	-	16x13	7,5	6
Speedake (Mikuni)	50	95-97	10 042 0900	-	16x13	9	6
Speedfight AC-LC	50	97-98	10 042 0900	-	16x13	9	6
Speedfight AC Cat	50	99	10 042 0900	-	16x13	9	6
Squab	50	95-97	10 042 0900	-	16x13	9	6
St Rapido	50	85-93	10 042 0750	-	16x13	7,5	6
Sv Geo	50	91-95	10 042 1100	-	16x13	11	6
Sv Geo (Mod:94)	50	91-95	10 042 0850	-	16x13	8,5	6
Trekker	50	98-00	10 042 0900	-	16x13	9	6
Vivacity	50	99	10 042 0900	-	16x13	9	6
Vivacity Catalitico	50	99-02	10 042 0900	-	16x13	9	6
Vivacity Vsx-Xr	50	02-04	10 042 0900	-	16x13	9	6
X-Fight	50	00	10 042 0900	-	16x13	9	6
Xrace	50	03	10 042 0900	-	16x13	9	6
Zenith L	50	94-96	10 042 0850	-	16x13	8,5	6
PGO							
Big Max	50		10 042 0850	-	16x13	8,5	6
PIAGGIO							
Diesis	50	01	10 045 0630	10 045 0642	19x15,5	6,4	6
Fly 2T	50	05-07	10 045 0750	10 045 0752	19x15,5	7,5	6
Fly 2T	50	10-11	10 045 0750	10 045 0752	19x15,5	7,5	6
Fly 4T	50	08	10 045 0630	10 045 0642	19x15,5	6,4	6
Fly 4T	50	08-11		10 045 0982	19x15,5	9,8	6
Fly 4T	50	12	10 045 0530	10 045 0532	19x15,5	5,3	6
Fly 4T 4V	50	12-13	10 045 0530	10 045 0532	19x15,5	5,3	6
Fly 4T Mot Chn	50	06-07	10 045 0630	10 045 0642	19x15,5	6,4	6
Free	50	92-94	10 042 0850	-	16x13	8,5	6
Free Delivery	50	00-01	10 045 0630	10 045 0642	19x15,5	6,4	6
Free FL	50	95-02	10 042 0850	-	16x13	8,5	6
Liberty	50	97-05	10 045 0630	10 045 0642	19x15,5	6,4	6
Liberty (Cat'00)	50	97-05	10 045 0750	10 045 0752	19x15,5	7,5	6
Liberty 2T	50	06-08	10 045 0750	10 045 0752	19x15,5	7,5	6
Liberty 2T Rst	50	04	10 045 0750	10 045 0752	19x15,5	7,5	6
Liberty 2T Sport	50	06-08	10 045 0750	10 045 0752	19x15,5	7,5	6
Liberty 4T	50	00-02	10 045 0530	10 045 0532	19x15,5	5,3	6
Liberty 4T	50	05-08	10 045 0750	10 045 0752	19x15,5	7,5	6
Liberty Moc 2T	50	09-11	10 045 0750	10 045 0752	19x15,5	7,5	6
Liberty 4T Delivery	50	10-11	10 045 0750	10 045 0752	19x15,5	7,5	6

KIT RULLI PULEGGIA MOTRICE

DRIVING PULLEY ROLLER SETS



MODELLO - MODELS	CC	ANNO YEAR	STANDARD	HIGH QUALITY	DIMENSIONI DIMENSIONS	PESO WEIGHT	PEZZI PCS
Liberty 4T PTT	50	09-11	10 045 0750	10 045 0752	19x15,5	7,5	6
Liberty 4T Sport	50	07-08	10 045 0750	10 045 0752	19x15,5	7,5	6
Liberty Ptt Eu2	50	04-05	10 045 0750	10 045 0752	19x15,5	7,5	6
Liberty 4T Rst	50	04	10 045 0630	10 045 0642	19x15,5	6,4	6
Liberty 4T Moc & Elle	50	09-11	10 045 0630	10 045 0642	19x15,5	6,4	6
Nrg	50	94-96	10 042 0850	-	16x13	8,5	6
Nrg Extreme	50	99-00	10 045 0630	10 045 0642	19x15,5	6,4	6
Nrg Mc3	50	01-04	10 045 0750	10 045 0752	19x15,5	7,5	6
Nrg Mc3 Acqua	50	01	10 045 0480	-	19x15,5	4,8	6
Nrg Power Dd	50	05-06	10 045 0630	10 045 0642	19x15,5	6,4	6
Nrg Power Dd Spec	50	07-08	10 045 0630	10 045 0642	19x15,5	6,4	6
Nrg Power Dt	50	06-11	10 045 0630	10 045 0642	19x15,5	6,4	6
Nrg Power Purejet	50	04-06	10 045 0530	10 045 0532	19x15,5	5,3	6
Nrg Power Purejet	50	10-11	10 045 0530	10 045 0532	19x15,5	5,3	6
Nrg Purejet	50	02-04	10 045 0530	10 045 0532	19x15,5	5,3	6
Nrg Purejet	50	10	10 045 0530	10 045 0532	19x15,5	5,3	6
Nrg Rst Mc2 (96-97)	50	96-98	10 042 0700	-	16x13	7	6
Nrg Rst Mc2 (98)	50	96-98	10 045 0530	10 045 0532	19x15,5	5,3	6
Ntt	50	95-96	10 042 0850	-	16x13	8,5	6
Quartz	50	92-96	10 042 0850	-	16x13	8,5	6
Sfera	50	91-93	10 044 0520	-	17x13,5	5,2	6
Sfera Maquillage 2	50	94	10 042 0850	-	16x13	8,5	6
Sfera Rst	50	95-97	10 042 0850	-	16x13	8,5	6
Typhoon	50	01-09	10 045 0630	10 045 0642	19x15,5	6,4	6
Typhoon 2T E2	50	10-12	10 045 0750	10 045 0752	19x15,5	7,5	6
Typhoon 2T E3 Ch	50	11	10 045 0750	10 045 0752	19x15,5	7,5	6
Vespa Et2	50	97-05	10 045 0630	10 045 0642	19x15,5	6,4	6
Vespa Et2 Iniezione	50	97-00	10 045 0750	10 045 0752	19x15,5	7,5	6
Vespa Et4	50	00-05	10 045 0530	10 045 0532	19x15,5	5,3	6
Vespa Lx 2T	50	05-08	10 045 0750	10 045 0752	19x15,5	7,5	6
Vespa Lx 2T FL	50	09-10	10 045 0750	10 045 0752	19x15,5	7,5	6
Vespa Lx 2T Touring	50	10-11	10 045 0750	10 045 0752	19x15,5	7,5	6
Vespa Lxv 2T	50	06-08	10 045 0750	10 045 0752	19x15,5	7,5	6
Vespa Lxv 2T Navy	50	08	10 045 0750	10 045 0752	19x15,5	7,5	6
Vespa Lx 4T-4V touring	50	10-13	10 045 0530	10 045 0532	19x15,5	5,3	6
Vespa Lx 4T-4V	50	09-13	10 045 0530	10 045 0532	19x15,5	5,3	6
Vespa Primavera	50	13-15	10 045 0530	10 045 0532	19x15,5	5,3	6
Vespa S 2T	50	07-11	10 045 0750	10 045 0752	19x15,5	7,5	6
Vespa S 4T-4V & College	50	13-15	10 045 0530	10 045 0532	19x15,5	5,3	6
Vespa S 4T-4V	50	08-11	10 045 0530	10 045 0532	19x15,5	5,3	6
Vespa Sprint 4T-4V	50	14	10 045 0530	10 045 0532	19x15,5	5,3	6
Zip	50	92-93	10 044 0520	-	17x13,5	5,2	6
Zip	50	00-04	10 045 0750	10 045 0752	19x15,5	7,5	6
Zip 2T	50	08-11	10 045 0750	10 045 0752	19x15,5	7,5	6
Zip 4T	50	00-12	10 045 0630	10 045 0642	19x15,5	6,4	6
Zip Fast Raider Rst	50	96-97	10 042 0850	-	16x13	8,5	6
Zip Fast Raider	50	96-97	10 042 0850	-	16x13	8,5	6



KIT RULLI PULEGGIA MOTRICE

DRIVING PULLEY ROLLER SETS

MODELLO - MODELS	CC	ANNO YEAR	STANDARD	HIGH QUALITY	DIMENSIONI DIMENSIONS	PESO WEIGHT	PEZZI PCS
Zip Rst	50	95-96	10 042 0850	-	16x13	8,5	6
Zip Bimodale	50	94-97	10 042 0850	-	16x13	8,5	6
Zip Rst	50	96-99	10 042 0850	-	16x13	8,5	6
Zip Sp	50	96-00	10 042 0700	-	16x13	7	6
Zip Sp	50	01-04	10 045 0630	10 045 0642	19x15,5	6,4	6
Zip Sp Eu2	50	06-12	10 045 0630	10 045 0642	19x15,5	6,4	6
Free	100	02-03	10 040 0420	-	20x15	7,3	6
Zip 4T	100	06-10	-	10 045 0982	19x15,5	9,8	6
Beverly	125	01-03	10 040 0320	10 040 0322	21x17	10,7	6
Beverly	125	01-03	-	10 040 0692	19x17	8,6	6
Beverly Eu3	125	07-08	10 040 0250	10 040 0252	19x17	7,3	6
Beverly Eu3 Mic	125	07	10 040 0250	10 040 0252	19x17	7,3	6
Beverly Eu3 Sport	125	07-08	10 040 0250	10 040 0252	19x17	7,3	6
Beverly Rst	125	04-07	10 040 0250	10 040 0252	19x17	7,3	6
Beverly Rst 4T 4V ie Eu3	125	10-12	10 040 0250	10 040 0252	19x17	7,3	6
Beverly Tourer Eu3	125	08-10	10 040 0250	10 040 0252	19x17	7,3	6
Carnaby	125	07-10	10 040 0250	10 040 0252	19x17	7,3	6
Fly	125	05-07	10 040 0260	-	19x17	8	6
Fly 4T 3V ie E3 Dt	125	13-15	-	10 040 0972	19x17	10,4	6
Fly 4T 3V ie Eu3 Lem	125	12-13	-	10 040 0972	19x17	10,4	6
Fly Eu3	125	07-08	-	10 040 0692	19x17	8,6	6
Fly 4T 3V ie Eu3 Lem	125	12-13	-	10 040 0972	19x17	10,4	6
Hexagon	125	94-97	10 040 0300	-	19x17	13	6
Hexagon Gtx	125	00	10 040 0250	10 040 0252	19x17	7,3	6
Hexagon Lx-Lxt	125	98-99	10 040 0140	-	19x17	14,5	6
Hexagon Lx4	125	98-99	10 040 0130	-	19x14	12	6
Liberty	125	98-00	10 040 0130	-	19x14	12	6
Liberty	125	01-02	-	10 040 0692	19x17	8,6	6
Liberty 4T	125	06-07	-	10 040 0692	19x17	8,6	6
Liberty 4T Eu3	125	07-08	-	10 040 0692	19x17	8,6	6
Liberty 4T Eu3 Delivery	125	08	-	10 040 0692	19x17	8,6	6
Liberty 4T Sport Eu3	125	06-08	-	10 040 0692	19x17	8,6	6
Liberty Rst	125	04-05	-	10 040 0692	19x17	8,6	6
Liberty Rst Ptt	125	05-11	-	10 040 0692	19x17	8,6	6
Liberty Sport	125	06	-	10 040 0692	19x17	8,6	6
Liberty Moc 4T & Elle	125	09-12	-	10 040 0692	19x17	8,6	6
Mp3	125	07-08	10 040 0250	10 040 0252	19x17	7,3	6
Mp3 ie	125	08-09	10 040 0250	10 040 0252	19x17	7,3	6
Mp3 Ibrido	125	09-10	10 040 0250	10 040 0252	19x17	7,3	6
Mp3 ie Touring	125	11	10 040 0250	10 040 0252	19x17	7,3	6
Mp3 Yourban Erl	125	11-12	10 040 0250	10 040 0252	19x17	7,3	6
Sfera	125	95-97	10 040 0130	-	19x14	12	6
Skipper	125	94-97	10 040 0160	-	19x17	12,5	6
Skipper 4T	125	00-02	-	10 040 0692	19x17	8,6	6
Skipper Lx	125	98-99	10 040 0300	-	19x17	13	6
Typhoon 4T 2V E3	125	10-11	-	10 040 0692	19x17	8,6	6
Super Hexagon Gtx 12"	125	01-02	10 040 0250	10 040 0252	19x17	7,3	6

KIT RULLI PULEGGIA MOTRICE

DRIVING PULLEY ROLLER SETS



MODELLO - MODELS	CC	ANNO YEAR	STANDARD	HIGH QUALITY	DIMENSIONI DIMENSIONS	PESO WEIGHT	PEZZI PCS
Vespa Et4	125	96-98	10 040 0130	-	19x14	12	6
Vespa Et4	125	99-02	-	10 040 0692	19x17	8,6	6
Vespa Granturismo	125	03-05	10 040 0320	10 040 0322	21x17	10,7	6
Vespa Granturismo Eu3	125	06-07	10 040 0250	10 040 0252	19x17	7,3	6
Vespa Gts Eu3	125	07-11	10 040 0250	10 040 0252	19x17	7,3	6
Vespa Gts 4T ie Super	125	09-12	10 040 0250	10 040 0252	19x17	7,3	6
Vespa Gtv	125	07-08	10 040 0250	10 040 0252	19x17	7,3	6
Vespa Gtv 4T Navy Eu3	125	08	10 040 0250	10 040 0252	19x17	7,3	6
Vespa Lx	125	05-06	-	10 040 0692	19x17	8,6	6
Vespa Lx 4T FL	125	09	-	10 040 0692	19x17	8,6	6
Vespa Lx 4T Eu3 Touring	125	10-11	-	10 040 0692	19x17	8,6	6
Vespa Lx Eu3	125	06-08	-	10 040 0692	19x17	8,6	6
Vespa Lxv ie 4T	125	10-12	-	10 040 0692	19x17	8,6	6
Vespa Lxv 4T Eu3	125	06-09	-	10 040 0692	19x17	8,6	6
Vespa Lxv 4T Navy Eu3	125	08	-	10 040 0692	19x17	8,6	6
Vespa Lx 4T 3V ie - Touring	125	12-13	-	10 040 0972	19x17	10,4	6
Vespa Lx 4T 3V ie - Touring	125	12-13	-	10 040 0972	19x17	10,4	6
Vespa S 4T Eu3	125	07-08	-	10 040 0692	19x17	8,6	6
Vespa S 4T ie & College	125	09-11	-	10 040 0692	19x17	8,6	6
Vespa S 4T 3V ie	125	12	-	10 040 0972	19x17	10,4	6
Vespa Lx Primavera 4T 3V ie	125	13-15	-	10 040 0992	19,2	19,2	6
Vespa Sprint 4T ie	125	14-15	-	10 040 0992	19,2	19,2	6
Vespa 946 4T 3V Abs	125	13-15	-	10 040 0972	19x17	10,4	6
X Evo	125	07-12	10 040 0250	10 040 0252	19x17	7,3	6
X7 Eu3	125	08	10 040 0250	10 040 0252	19x17	7,3	6
x7 Evo Ie Eu3	125	09-10	10 040 0250	10 040 0252	19x17	7,3	6
X8	125	04-06	10 040 0320	10 040 0322	21x17	10,7	6
X8 Premium Eu2	125	06	10 040 0250	10 040 0252	19x17	7,3	6
X8 Premium Eu3	125	06-07	10 040 0250	10 040 0252	19x17	7,3	6
X8 Street Eu2	125	06-07	-	10 040 0692	19x17	8,6	6
X9	125	01-02	10 040 0250	10 040 0252	19x17	7,3	6
X9 Evolution	125	03-06	10 040 0250	10 040 0252	19x17	7,3	6
X9 Evolution Eu3	125	07	10 040 0250	10 040 0252	19x17	7,3	6
X10 4T 4V ie Eu3	125	12	10 040 0250	10 040 0252	19x17	7,3	6
Zip	125	00-02	-	10 040 0692	19x17	8,6	6
Fly	150	05-07	10 040 0270	10 040 0272	19x17	10	6
Fly Eu3	150	08-11	10 040 0270	10 040 0272	19x17	10	6
Liberty	150	01-02	10 040 0270	10 040 0272	19x17	10	6
Liberty 4T Eu3 - Sport	150	08	10 040 0270	10 040 0272	19x17	10	6
Liberty Moc 4T	150	09-10	10 040 0270	10 040 0272	19x17	10	6
Liberty 4T 3V Lem	150	13-14	-	10 040 0982	19x17	15,6	6
Skipper	150	94-97	10 040 0160	-	19x17	12,5	6
Skipper 4T	150	00-02	10 040 0270	10 040 0272	19x17	10	6
Skipper Lx	150	98-99	10 040 0300	-	19x17	13	6
Vespa Et4	150	99-02	10 040 0270	10 040 0272	19x17	10	6
Vespa Lx	150	05-06	10 040 0270	10 040 0272	19x17	10	6
Vespa Lx 4T FL	150	09	10 040 0270	10 040 0272	19x17	10	6



KIT RULLI PULEGGIA MOTRICE

DRIVING PULLEY ROLLER SETS

MODELLO - MODELS	CC	ANNO YEAR	STANDARD	HIGH QUALITY	DIMENSIONI DIMENSIONS	PESO WEIGHT	PEZZI PCS
Vespa Lx Eu3	150	06-08	10 040 0270	10 040 0272	19x17	10	6
Vespa Lx Eu3 ie	150	09-11	10 040 0270	10 040 0272	19x17	10	6
Vespa Lx Touring	150	10-11	10 040 0270	10 040 0272	19x17	10	6
Vespa Lt 4T 3V ie	150	14	-	10 040 0982	19x17	15,6	6
Vespa Gts Super ie 4T 3V	150	14-15	-	10 040 0982	19x17	15,6	6
Vespa Primavera 4T 3V	150	13-15	-	10 040 0982	19x17	15,6	6
Vespa S 4T	150	08-09	10 040 0270	10 040 0272	19x17	10	6
Vespa S 4T ie	150	09-11	10 040 0270	10 040 0272	19x17	10	6
Vespa Sprint 4T 3V ie	150	15	-	10 040 0982	19x17	15,6	6
X8 Street Eu2	150	06-08	10 040 0270	10 040 0272	19x17	10	6
Hexagon Gtx	180	00	10 040 0320	10 040 0322	21x17	10,7	6
Hexagon Lx-Lxt	180	98-99	10 040 0150	-	20x17	15	6
Super Hexagon Gtx 12"	180	01-02	10 040 0320	10 040 0322	21x17	10,7	6
X9 Amalfi	180	00-03	10 040 0320	10 040 0322	21x17	10,7	6
Beverly	200	01-03	10 040 0320	10 040 0322	21x17	10,7	6
Carnaby	200	07-08	10 040 0320	10 040 0322	21x17	10,7	6
Liberty	200	06	10 040 0320	10 040 0322	21x17	10,7	6
Liberty 4T Eu3	200	07-08	10 040 0320	10 040 0322	21x17	10,7	6
Liberty 4T Sport Eu3	200	06-07	10 040 0320	10 040 0322	21x17	10,7	6
Liberty Rst	200	04	10 040 0320	10 040 0322	21x17	10,7	6
Liberty Sport	200	06	10 040 0320	10 040 0322	21x17	10,7	6
Vespa Granturismo	200	03-07	10 040 0320	10 040 0322	21x17	10,7	6
X8	200	05-07	10 040 0320	10 040 0322	21x17	10,7	6
X8 125-200	200	04	10 040 0320	10 040 0322	21x17	10,7	6
X9	200	02-03	10 040 0320	10 040 0322	21x17	10,7	6
X9 Evolution	200	03	10 040 0320	10 040 0322	21x17	10,7	6
Beverly	250	06-07	-	10 040 0672	21x17	11,2	6
Beverly Cruiser	250	07-09	-	10 040 0842	21x17	13,8	6
Beverly Eu3 Mic	250	07	-	10 040 0842	21x17	13,8	6
Beverly ie Eu3	250	06-08	-	10 040 0842	21x17	13,8	6
Beverly Rst	250	04-05	-	10 040 0672	21x17	11,2	6
Beverly Sport	250	06-08	-	10 040 0842	21x17	13,8	6
Beverly Tourer Eu3	250	08-09	-	10 040 0842	21x17	13,8	6
Carnaby	250	08	-	10 040 0842	21x17	13,8	6
Hexagon Gt-Gtx	250	98-00	10 040 0070	-	24x18	23	6
Mp3	250	06-08	-	10 040 0672	21x17	11,2	6
Mp3 Lt	250	09	-	10 040 0672	21x17	11,2	6
Mp3 Mic	250	08-09	-	10 040 0672	21x17	11,2	6
Vespa Gt 60 Eu3	250	06-07	-	10 040 0672	21x17	11,2	6
Vespa Gts- Abs	250	05-11	-	10 040 0672	21x17	11,2	6
Vespa Gtv	250	06-09	-	10 040 0672	21x17	11,2	6
Vespa Gtv 4T Navy	250	08	-	10 040 0672	21x17	11,2	6
X7 Eu3	250	08	-	10 040 0672	21x17	11,2	6
X8 Eu3	250	05-08	-	10 040 0672	21x17	11,2	6
X9	250	00-01	10 040 0560	-	23x18	24	6
X9 Evolution	250	04-06	-	10 040 0672	21x17	11,2	6
Xevo	250	07-11	-	10 040 0672	21x17	11,2	6

KIT RULLI PULEGGIA MOTRICE
DRIVING PULLEY ROLLER SETS



MODELLO - MODELS	CC	ANNO YEAR	STANDARD	HIGH QUALITY	DIMENSIONI DIMENSIONS	PESO WEIGHT	PEZZI PCS
Beverly 300 ie Tourer	300	09-10	-	10 040 0842	21x17	13,8	6
Beverly Rst 4T 4V ie Eu3	300	10-12	-	10 040 0842	21x17	13,8	6
Carnaby Cruiser	300	09-11	-	10 040 0842	21x17	13,8	6
Mp3 ie Lt	300	10-11	-	10 040 0842	21x17	13,8	6
Mp3 ie Mic	300	10-11	-	10 040 0842	21x17	13,8	6
Mp3 4T 4V Lt Ibrido	300	10-11	-	10 040 0842	21x17	13,8	6
Mp3 ie Lt Touring	300	11	-	10 040 0842	21x17	13,8	6
Mp3 ie Lt – ie Lt Sport	300	11-13	-	10 040 0842	21x17	13,8	6
Mp3 Lt Sport – Business Abs	300	14	-	10 040 0842	21x17	13,8	6
Mp3 ie Touring	300	11	-	10 040 0842	21x17	13,8	6
Mp3 Yourban Erl	300	11-15	-	10 040 0842	21x17	13,8	6
Mp3 Yourban Lt Erl	300	11-12	-	10 040 0842	21x17	13,8	6
Vespa Gts Super	300	08-11	-	10 040 0842	21x17	13,8	6
Vespa Gts ie Touring	300	11-12	-	10 040 0842	21x17	13,8	6
Vespa Gts ie & Touring	300	12-15	-	10 040 0842	21x17	13,8	6
Vespa Gts ie	300	12	-	10 040 0842	21x17	13,8	6
Vespa Gts Super Sport	300	10-13	-	10 040 0842	21x17	13,8	6
Vespa Gtv 4T ie	300	10-13	-	10 040 0842	21x17	13,8	6
Vespa Gtv Via Montenapoleone	300	10	-	10 040 0842	21x17	13,8	6
X7 Evo ie Eu3	300	09-10	-	10 040 0842	21x17	13,8	6
Beverly Eu3	400	06-07	-	10 040 0642	25x17	18,6	6
Beverly Tourer Eu3	400	08-10	-	10 040 0642	25x17	18,6	8
Mp3	400	07-08	-	10 040 0642	25x17	18,6	8
Mp3 Lt	400	09	-	10 040 0642	25x17	18,6	8
Mp3 Mic	400	08-11	-	10 040 0642	25x17	18,6	8
Mp3 ie Lt -Sport	400	08-10	-	10 040 0642	25x17	18,6	8
Mp3 ie Lt Touring	400	11	-	10 040 0642	25x17	18,6	8
Mp3 ie Rt Touring	400	11	-	10 040 0642	25x17	18,6	8
X Evo	400	07-09	-	10 040 0642	25x17	18,6	8
X8 Eu3	400	06-08	-	10 040 0642	25x17	18,6	8
Beverly	500	02-04	10 040 0480	-	25x22	27,3	8
Beverly	500	05-06	-	10 040 0652	25x17	21,4	6
Beverly Cruiser	500	07-12	-	10 040 0652	25x17	21,4	8
Beverly Eu3	500	06-08	-	10 040 0652	25x17	21,4	8
Mp3 Lt Sport – Business	500	11-13	-	10 040 0652	25x17	21,4	8
Mp3 RI Sport – Business	500	11-12	-	10 040 0652	25x17	21,4	8
X9	500	01-02	10 040 0500	-	25x22	29	8
X9 Evolution	500	03-05	10 040 0480	-	25x22	27,3	8
X9 Evolution–Abs	500	06-07	-	10 040 0652	25x17	21,4	8
X10 4T 4V ie Eu3	500	12-14	-	10 040 0652	25x17	21,4	8
SUZUKI							
Address	50	92-95	10 043 0660	-	17x12	6,6	6
Aj Zz Sepia S	50	95-97	10 043 0660	-	17x12	6,6	6
Ap R-T (R7)	50	94-97	10 043 0660	-	17x12	6,6	6
AY AYW K1-K4	50	01-04	10 043 0660	-	17x12	6,6	6
Katana V-Y	50	97-00	10 043 0720	-	17x12	7,2	6
Zillion	50	99	10 043 0680	-	17x12	6,8	6



KIT RULLI PULEGGIA MOTRICE

DRIVING PULLEY ROLLER SETS

MODELLO - MODELS	CC	ANNO YEAR	STANDARD	HIGH QUALITY	DIMENSIONI DIMENSIONS	PESO WEIGHT	PEZZI PCS
Burgman K2-K6	125	02-06	10 040 0170	-	20x15	13	6
Burgman K7-L0	125	07-10	10 040 0170	-	20x15	13	6
Burgman L1	125	11	10 040 0170	-	20x15	13	6
Sixteen	125	08-11	10 040 0470	-	20x17	10	6
Uc Epicuro X - K1	125	99-01	-	10 040 0902	20x15	14	6
Epicuro	150	99-01	10 040 0170	-	20x15	13	6
Ux Sixteen K8 - L0	150	08-10	-	10 040 0902	20x15	14	6
Sixteen	150	08-11	10 040 0470	-	20x17	10	6
Uh Burgman K7-L0	200	07-10	-	10 040 0892	24x17	14	6
Uh Burgman L1	200	11-12	-	10 040 0892	24x17	14	6
Uh Burgman L3	200	13	-	10 040 0892	24x17	14	6
Burgman	250	03-06	10 040 0180	-	24x18	31	6
Burgman	250	98-02	10 040 0180	-	24x18	31	6
Burgman	400	99-02	10 040 0190	-	26x13	21,4	8
Burgman	400	03-12	10 040 0620	-	26x13	19	8
YAMAHA							
Aerox	50	97-12	10 041 0550	-	15x12	5,5	6
Aerox Eu2	50	03	10 041 0550	-	15x12	5,5	6
Aerox R	50	99-00	10 041 0550	-	15x12	5,5	6
Axis	50	95-96	10 041 0650	-	15x12	6,5	6
Breeze	50	94-95	10 041 0700	-	15x12	7	6
Bw'S	50	03	10 041 0620	-	15x12	6,2	6
Bw'S	50	04-05	10 041 0550	-	15x12	5,5	6
Bw'S	50	06-12	10 041 0550	-	15x12	5,5	6
Bw'S Bump	50	97-98	10 041 0700	-	15x12	7	6
Bw'S Naked	50	03	10 041 0620	-	15x12	6,2	6
Bw'S Naked	50	04	10 041 0550	-	15x12	5,5	6
Bw'S Naked	50	09-12	10 041 0550	-	15x12	5,5	6
Bw'S Next Generation	50	01-06	10 041 0620	-	15x12	6,2	6
Bw'S Next Generation	50	04-06	10 041 0550	-	15x12	5,5	6
Bw'S Next Generation	50	97-98	10 041 0700	-	15x12	7	6
Bw'S Next Generation	50	99	10 041 0650	-	15x12	6,5	6
Bw'S Next Generation Cat.	50	99-00	10 041 0650	-	15x12	6,5	6
Bw'S Original	50	01-02	10 041 0620	-	15x12	6,2	6
Bw'S Original	50	97-98	10 041 0700	-	15x12	7	6
Bw'S Original	50	99-00	10 041 0650	-	15x12	6,5	6
Bw'S Original Eu2	50	02	10 041 0620	-	15x12	6,2	6
Bw'S Original Eu2	50	03	10 041 0620	-	15x12	6,2	6
Bw'S R	50	01	10 041 0620	-	15x12	6,2	6
Cr Z	50	91-95	10 041 0650	-	15x12	6,5	6
Ct Ss	50	92-95	10 041 0650	-	15x12	6,5	6
Cts	50	90-95	10 041 0650	-	15x12	6,5	6
Jog R	50	02-11	10 041 0650	-	15x12	6,5	6
Jog R Eu2	50	02-05	10 041 0650	-	15x12	6,5	6
Neo'S	50	97-12	10 041 0650	-	15x12	6,5	6
Neo'S Eu2	50	02-03	10 041 0650	-	15x12	6,5	6
Slider	50	00-02	10 041 0620	-	15x12	6,2	6

KIT RULLI PULEGGIA MOTRICE
DRIVING PULLEY ROLLER SETS



MODELLO - MODELS	CC	ANNO YEAR	STANDARD	HIGH QUALITY	DIMENSIONI DIMENSIONS	PESO WEIGHT	PEZZI PCS
Spy	50	95-98	10 041 0700	-	15x12	7	6
Why	50	98-02	10 041 0650	-	15x12	6,5	6
Why Eu1	50	99-00	10 041 0650	-	15x12	6,5	6
Why Eu2	50	03-05	10 041 0650	-	15x12	6,5	6
Aerox	100	00-02	10 041 0900	-	15x12	9	6
Bw'S	100	99-01	10 041 0830	-	15x12	8,3	6
Neo'S	100	99-02	10 041 0900	-	15x12	9	6
Yw Bw's	125	10	10 040 0220	-	20x12	12	6
Cygnus - Cygnus R	125	95-98	10 040 0390	-	20x12	11,5	8
Cygnus - Cygnus R	125	97	10 040 0220	-	20x12	12	6
Cygnus R	125	99-03	10 040 0370	-	20x12	10,5	6
Hw Xenter	125	12-15	-	10 040 0912	20x12	13	6
Majesty	125	98-00	10 040 0340	-	20x12	8,5	6
Majesty	125	01-02	10 040 0040	-	20x12	14	8
Majesty	125	03-05	10 040 0370	-	20x12	10,5	6
Maxster	125	01-02	10 040 0370	-	20x12	10,5	6
Teo'S	125	00	10 040 0370	-	20x12	10,5	6
Xc125 Majesty S	125	14	-	10 040 0912	20x12	13	6
X-City	125	08-11	10 040 0370	-	20x12	10,5	6
X-Max	125	06-14	10 040 0370	-	20x12	10,5	6
X-Max Abs	125	13-14	10 040 0370	-	20x12	10,5	6
Hw Xenter	150	12-15	-	10 040 0912	20x12	13	6
Teo'S	150	01-02	10 040 0040	-	20x12	14	8
Maxster	150	01-02	10 040 0040	-	20x12	14	8
Majesty	150	01-02	10 040 0040	-	20x12	14	8
Majesty	180	03-06	10 040 0410	-	20x12	15,3	8
Black X-Max	250	09	10 040 0770	-	20x12	12	6
Majesty	250	00-03	10 040 0390	-	20x12	11,5	8
Majesty	250	96-98	10 040 0040	-	20x12	14	8
Majesty Abs	250	03	10 040 0390	-	20x12	11,5	8
Majesty Dx	250	98-99	10 040 0040	-	20x12	14	8
X-Max	250	05-09	10 040 0040	-	20x12	14	8
X-City	250	08-12	10 040 0770	-	20x12	12	8
X-Max -Abs- Sport	250	07-12	10 040 0770	-	20x12	12	8
Versity	300	03-06	10 040 0410	-	20x12	15,3	8
Majesty	400	04-08	10 040 0660	-	25x15	15	8
Majesty Abs	400	07-08	10 040 0660	-	25x15	15	8
Majesty - Abs	400	09-12	-	10 040 0832	25x15	18	8
Yp X-Max	400	13-14	-	10 040 0862	25x15	17	8
T-Max- Abs -Black M.-White M.-Night M.	500	04-11	-	10 040 0832	25x15	18	8
T-Max	500	01-03	-	10 040 0922	25x15	20	8
T-Max	530	12-13	-	10 040 0832	25x15	18	8
T-Max Abs	530	12-13	-	10 040 0832	25x15	18	8



KIT TAGLIANDO SCOOTER

SERVICE KIT FOR SCOOTER



CODICE KIT TAGLIANDO SERVICE KIT CODE	PASTIGLIE - GANASCIA BRAKE PADS - BRAKE SHOES		FILTRO ARIA AIR FILTER	FILTRO OLIO OIL FILTER CHAMPION	CANDELA SPARK PLUG CHAMPION	CINGHIA BELT DAYCO	RULLINI ROLLERS
	ANT-FRONT	POST-REAR					
APRILIA: Scarabeo 50 4t 06-09 Scarabeo 4t 4v Net 09 Scarabeo Restyling Eu3 06-09 Scarabeo Quattro 09							
16 382 0090 	22 510 0190	22 512 0421	10 060 2100 (AP8202249) Aspirazione - Intake 10 060 1180 (832972) Carter	-	24 621 0220	16 375 0069 (480852)	10 045 0532 (CM1102035) 19 X 15,5 5,3GR
HONDA: Sh 125 02-08							
16 382 0050 	22 510 0270	22 512 0471	10 060 1131 (17210KGF900)	-	24 621 0500	16 375 0479 (23100KGF91)	10 040 0430 20 X 15 11,5GR
HONDA: Sh 125 >09							
16 382 0060 	22 510 2540	22 510 2560	10 060 1131 (17210KGF900)	-	24 621 0500	16 375 0479 (23100KGF91)	10 040 0430 20 X 15 11,5GR
HONDA: Sh 150 I							
16 382 0070 	22 510 2540	22 510 2560	10 060 1131 (17210KGF900)	-	24 621 0500	16 375 0739 (23100KGF901)	10 040 0440 20 X 15 12,5GR
HONDA: Sh 150 01-08							
16 382 0080 	22 510 0270	22 512 0471	10 060 1131 (17210KGF900)	-	24 621 0500	16 375 0739 (23100KGF901)	10 040 0440 20 X 15 12,5GR
KYMCO: 50 4t 12"							
16 382 0170 	22 510 0580	22 512 0091	10 060 2390 (0164044)	-	24 621 0400	16 375 0330 (00107541)	10 042 0650 16 x 13 6,5GR
KYMCO: 50 4t 10"							
16 382 0180 	22 510 0580	22 512 0091	10 060 2400 (0163126)	-	24 621 0400	16 375 0330 (00107541)	10 042 0650 16 x 13 6,5GR
KYMCO: Agility 125 R16							
16 382 0040 	22 510 2710	22 510 1200	10 060 2310 (0162377)	-	24 621 0400	16 375 0441 (00127541) 	10 040 0090 18 X 14 13 GR
MBK: Booster 50							
16 382 0140 	22 510 0190	22 512 0061	10 060 0310 (3VLE44510100)	-	24 621 0200	16 375 0089	10 041 0650 15 x 12 6,5GR
PEUGEOT: Tkr 50							
16 382 0160 	22 510 0080	22 512 0091	10 060 0370 (730199)	-	24 621 0130	16 375 0169	10 042 0900 16 X 13 9GR 6PZ
PIAGGIO: Zip 50 2t 08-13							
16 382 0130 	22 510 0300	22 512 0351	10 060 0920 (487719) Aspirazione - Intake 10 060 1190 (486942) Carter	-	24 621 0270	16 375 0050 (478954)	10 045 0752 (CM1102015) 19X15,5 7,5GR
PIAGGIO: Liberty 125 Ptt 05-11							
16 382 0020 	22 510 0300	22 512 0421	10 060 0910 (487287)	10 060 9045 (86235R)	24 621 0250	16 375 0389 (841213)	10 040 0692 (CM1038035) 19 X 17 8,6GR

KIT TAGLIANDO SCOOTER

SERVICE KIT FOR SCOOTER













RMS
MOTORCYCLE PARTS

DAYCO

CHAMPION



CODICE KIT TAGLIANDO SERVICE KIT CODE	PASTIGLIE - GANASCIA BRAKE PADS - BRAKE SHOES		FILTRO ARIA AIR FILTER	FILTRO OLIO OIL FILTER 	CANDELA SPARK PLUG 	CINGHIA BELT 	RULLINI ROLLERS
	ANT-FRONT	POST-REAR					
PIAGGIO: Vespa Lx 125 05-11							
16 382 0100 	22 510 0300	22 512 0351	10 060 1160 (843194)	10 060 9045 (86235R)	24 621 0500	16 375 0389 (841213)	10 040 0692 (CM1038035) 19 X 17 8,6GR
PIAGGIO: Vespa Gts 125 le 07-12							
16 382 0190 	22 510 2620	22 510 0450	10 060 2560 (842093) Variatore - Pulley 10 060 2110 (831997) Aspirazione - Intake	10 060 9045 (86235R)	24 621 0210	16 375 0389 (841213)	10 040 0252 (CM1038045) 19 X 17 7,3GR
PIAGGIO: Vespa Gts 300 10-13							
16 382 0120 	22 510 2620	22 510 0450	10 060 2560 (842093) Variatore - Pulley 10 060 2110 (831997) Aspirazione - Intake	10 060 9045 (86235R)	24 621 0500	16 375 0810 (843963)	10 040 0842 (CM849480) 21 X 17 13,8GR
PIAGGIO: Mp3 400							
16 382 0030 	22 510 0300	22 510 2620	10 060 0990 (829258)	10 060 9075	24 651 0250	16 375 0680 (832738)	10 040 0642 (849914) 25 X 17 18,6GR 8PZ
YAMAHA: Aerox 50							
16 382 0150 	22 510 0190	22 510 0280	10 060 0060 (3KJ144510000)	-	24 621 0200	16 375 0089	10 041 0550 15 x 12 5,5GR
YAMAHA: X-Max 125 06-09							
16 382 0010 	22 510 0770	22 510 0490	10 060 2410 (1B9144510000)	10 060 9385	24 621 0500	16 375 0800 (B9E7641000)	10 040 0370 20 X 12 10,5GR
YAMAHA: Majesty 125 06-09							
16 382 0110 	22 510 0430	22 510 0490	10 060 0870 (SDS154070100) Variatore - Pulley 10 060 0790 (SDSE44510000) Aspirazione - Intake	-	24 621 0240	16 375 0300 (NSE7641000)	10 040 0370 20 X 12 10,5GR



SETTORI MESSA IN MOTO

KICK STARTER SECTOR

10 025 0010



50: MINARELLI - MBK - YAMAHA
(R.O. 3E5156010100)



10 025 0020



APRILIA 50: Sonic
MALAGUTI 50: F10 • Yesterday
MBK 50: Evolis • Fizz • Forte
YAMAHA 50: Breeze • Axis
(R.O. 70104100)



10 025 0600



GILERA 50 : Dna • Easy Moving
Ice • Runner • Stalker Storm • Typhoon • X • XR
PIAGGIO 50: Diesis • Free • FL • Delivery
• Liberty - 2/4T • Ntt • Nrg • Mc3
Rst • Mc2 • Extreme • Quartz • Sfera Rst •
Maquillage • Base • Skr City • Typhoon
Vespa Et2 • Iniez. Et4 • Zip • 2/4 T • Base
Rst • Fast • Rider Rst • Sp
(R.O. 488079)



10 025 0620



PIAGGIO 125: Liberty 98-00 • Sfera Rst 95-97 •
Vespa Et4 • 96-99-Hexagon LX 4 98-99
(R.O. 478723)



10 025 0630



GILERA 125: Runner Fx • Fxr-Typhoon • X • Xr •
95-00
PIAGGIO 125-150: Hexagon • Skipper
Skipper Lx 94-99
125-180: Hexagon LX • Lxt
(R.O. 434087)



10 025 0680



KYMCO 50: Agility 4T Carry 11 • Agility 4T R12
07-08 • Agility Rs 09 • Agility R12 05 • Cx 93-97 •
Dink 4T 07 • Dj 93-00 • Fever Zx 99-04 • K12 95-
00 • Kb 95-00 • Like 4T 09 • Super 8 07 • Super 8
4T 09 • Vitality 4T 04 People S 4T 06-08
(R.O. 00106010)



10 025 0640



PIAGGIO 125-150 : Et4 99-01 • Liberty • Zip
• Skipper 4T 00>
(R.O. 830284)



10 025 0660



PIAGGIO 150: Vespa GL Sprint
(R.O. 140920)



10 025 0670



PIAGGIO 50: Vespa S • Vespa R • Vespa Pk • SS
125: Vespa Et3 Primavera
(R.O. 79734)





10 025 4610 

GILERA 50: Scooter 2/4 T
PIAGGIO 50: Scooter 2/4 T
125-150: Vespa Et4 >99
 (R.O. 483537)



10 025 4620 

PIAGGIO 125: Hexagon Lx4 98-99 • Zip 4T 00 ET4 97>
125-150: Skipper 4T 00 • Liberty 98-01 • Vespa Et4 10-99>
 (R.O. 483539)



10 025 4630 

GILERA 125: Runner • Fx • Fxr >98 Typhoon 95-98 • X 99-00
PIAGGIO 125-150: Hexagon Lx • Hexagon • Skipper 94-97
 (R.O. 432491)



10 025 4640 

GILERA 125: Typhoon Xr
125-180: Runner - Fx - Fxr 97-02
PIAGGIO 125-150: Skipper LX 98
180: Hexagon Lxt
 (R.O. 483538)



10 025 4650 

50: MINARELLI-MBK- YAMAHA



10 025 4660 

PIAGGIO 50: Ape FL • FL2 89-95 • Ape FL3 Europa 96-99 • Ape Rst Mix 99-05 • Ape Tm P 85-89 • Vespa FL 90 • Vespa FL2 Automatica 90-91 • Vespa FL2 Hp 91-97 • Vespa N 89-90 Vespa Pk XL Plurimatic 85-90 • Vespa Pk XL Rush 99-89 • Vespa Px XL 85-88 •
50-125: Vespa Pk 82-84 • Vespa Pk S Automatica 84-89 • Vespa FL 89-90 • Vespa Pk XL 86-89 • Vespa Px 30 Anni 07-08 • Vespa Px Eu 2 01-07
125-150-200: Cosa 2 91-97 • Cosa CL-CLX 88-91 • Vespa Pxe Arcobaleno 91-97
 (R.O. 248293)



10 025 4680 

Dentatura: 14/65 • *Sprockets:* 14/65
KYMC0 50: Agility 2T R16 10 • 4T Carry 11 • 4T R10 06-08 • 4T R12 07-08 • 4T R16 08-09 • R12 05 • Rs Naked 2T 10 • Rs 09 • Dink 4T 07 • Filly Lx 01-02 • Like 4T 09 • People Eu2 11 • People S 4T 06-08 • Sento 08 • Super 8 4T 09 • Super 8 07 • Vitality 4T 04
 (R.O. 00107245)



10 025 4710 

Dentatura: 13/47 • *Sprockets:* 13/47
PIAGGIO 125: Hexagon Lx4 98-99 • Liberty 98-00 • Sfera 95-97 • Vespa Et4 96-98
 (R.O. 293799)



10 025 4720 

Dentatura: 14/47 • *Sprockets:* 14/47
APRILIA 100: Scarabeo 4T Net Eu3 10 • Scarabeo 4T Net 10 • Scarabeo 4T Restyling 06-09 • Scarabeo 4T 10-12
DERBI 50-100: Atlantis 4T 04-06
GILERA 125-180: Runner Fx-Fxr 97-02 • Typhoon X-Xr 99-00 • Typhoon 95-98
PIAGGIO 100: Fly 4T 06-08 • Free 02-03 • Zip 4T 06-10
125: Hexagon Lx-Lxt 98-99 • Hexagon 94-97 • Skipper Lx 98-99 • Skipper 94-97
 (R.O. 431321)





PIGNONI MESSA IN MOTO

STARTER PINION

10 025 4670



Dentatura: 14/63 - Sprockets: 14/63

APRILIA 50: Mojito 04-08 • Scarabeo 2T Eu2 Motore Piaggio 10-12 • Scarabeo 2T Net 09-10 • Scarabeo Street 2T Restyling 06-09 • Sport City One 2T 08-11 • Sr R Factory ie e Carburatore - *Carburetor* 10-12 • Sr R Factory 04-09

DERBI 50: Atlantis 2T Eu2 07-09 • Atlantis 2T 10 • Atlantis 02 Bullet 03-05 • Atlantis 02 City 03-06 • Atlantis 02 Red Bullet 03 • Atlantis 02 Two Chic 05 • Atlantis 02 02 • Boulevard 2T 09 • Gp1 Eu2 05 • Gp1 Open Eu2 06-09 • Gp1 Race Eu2 05-07 • Gp1 01-03 • Sonar 2T 09

GILERA 50: Dna Gp Experience 03-04 • Dna 00-07 • Easy Moving 95-96 • Ice 01-05 • Runner Poggiali 02 • Runner Sp Special Edition 07 • Runner Sp St & Simoncelli 08-09 • Runner Sp 02-07 • Runner 97-00 • Stalker Naked 08 • Stalker S. E. 07-08 • Stalker 97-11 • Storm Eu2 07 • Storm 94-95 • Typhoon X 98-99 • Typhoon Xr 00 • Typhoon 94-97 • Runner Sp 10-11

PIAGGIO 50: Diesis 01 • Fly 2T 05-11 • Free Delivery 01-01 • Free FL 95-02 • Free 92-94 • Liberty 2T Rst 04 • Liberty 2T Sport 06-08 • Liberty 2T 06-08 • Liberty Ptt Eu2 04-05 • Liberty 97-05 • Nrg Extreme 99-00 • Nrg Mc3 01-04 • Nrg power Dd Serie Speciale 07-11 • Nrg Power Dd 10 • Nrg Power Dt Serie Speciale 07-08 • Nrg Power Dt 06 • Nrg Rst Mc2 96-98 • Nrg 94-96 • Ntt 95-96 • Quartz 92-95 • Sfera Maquillage 2 94 • Sfera Rst 95-97 • Sfera 91-93 • Typhoon 2T E2 10-12 • Typhoon 2T E3 Ch 11 • Typhoon 01-09 • Vespa Et2 Iniezione 97-00 • Vespa Et2 97-05 • Vespa Lx 2T FL 09-10 • Vespa Lx 2T 05-08 • Vespa Lxv 2T Navy 08 • Vespa Lxv 2T 06-08 • Zip 2T 08-11 • Zip Bimodale 94-97 • Zip fast Raider Rst 96-97 • Zip Fast Raider 93-94 • Zip Rst 96-99 • Zip Sp Eu2 06-12 • Zip Sp 96-04 • Zip 92-94 • Liberty Moc 2T & Elle 09-11 • Nrg power Dt 07-11 • Vespa Lx 2T Touring 10-11 • Vespa S 2T & Colledge 07-11 (R.O. 82531R)



10 025 4700



Dentatura: 14/55 - Sprockets: 14/55

APRILIA 50: Rs 06-10 • Scarabeo 4T 4V Net 09-10 • Scarabeo 4T 4V 10 • Scarabeo 4T Restyling Eu 3 06-09 • Scarabeo Quattro 09 • Sport City One 4T 08-10 • Sr Factory ie e Carburatore - *Carburetor* 10-12 • Sr R - R Factory 04-09

DERBI 50: Atlantis 4T Eu 2 07 • Atlantis 50-100 4T 04-06 • Boulevard 4T Eu 2 25 Km/h 09 • Gpr 2T Eu2 09-10 • Gpr Nude & Gpr Nude Tuning 06-08 • Gpr nude Sport 06 • Gpr R Eu2 - Gpr Replica Eu2 08 • Gpr Racing Eu2 06 • Gpr Replica & Gpr R Eu2 06 • Gpr Replica 2T malossi 07 • Gpr Replica Pesek Eu2 07 • Senda R Drd Pro Eu 2 05-11 • Senda Sm Drd Pro Eu 2 05-11

GILERA 50: Runner Purejet St 08 • Runner Purejet 02-11

PIAGGIO 50: Fly 4T Motore Chn 06-07 • Fly 4T 05-11 • Liberty 4T Delivery Tnt 09 • Liberty 4T Delivery 10-11 • Liberty Ptt 09-11 • Liberty Rst 04 • Liberty 4T Sport 06-08 • Liberty 4t 00-08 • Liberty moc 4T & Elle 09-11 • Nrg Power Purejet 04-11 • Nrg purejet 02-10 • Vespa Et4 00-05 • Vespa Lx 4T-4V Touring 10-11 • Vespa Lx 4T-4V 09-11 • Vespa Lx 4T 05-08 • Vespa S 4T-4V & Colledge 08-11 • Zip 4T 00-10 (R.O. 96922R)



10 025 4730



Dentatura: 14/40 - Sprockets: 14/40

APRILIA 125: Atlantic Eu3 125-250 06-08 • Atlantic Eu3 10-11 • Mojito 03-08 • Sport >City Cube 08-10 • Sport City Eu3 06-08 • Sport City One Eu3 08-10 • Sport City 04-06

DERBI 125: Boulevard 125-150 Eu3 04-07 • Boulevard 125-150 02-04 • Gp1 Eu2 06 • Gp1 Low seat Eu3 07-08 • Rambla 125-250 E3 2 vers. 08 • Rambla 125-250 08-09 • Sonar 4T 09 • **150:** Boulevard 4T E3 10

200: Boulevard 05

GILERA 125: Dna 125-180 01 • Nexus Eu 3 07-08 • Runner Vx 4T Eu3 06-07 • Runner Vx 4T St Eu 3 08-11 • Runner Vx Race 06 • Runner Vx Sc 06-07 • Runner Vx-Vxr 125-180 00-01 • Runner Vx-Vxr 125-200 02-04 • Runner Vx 05-06

200: Runner Vxr 4T St Eu3 08-11 • Runner Vxr Eu3 07 • Runner Vxr Race 06 • Runner Vxr 05-06

PIAGGIO 125: Beverly Eu3 Mic 07 • Beverly Eu3 Sport 07-08 • Beverly Eu3 07-08 • Beverly Rst 04-07 • Beverly Tourer Eu3 08-10 • Beverly 01-03 • Carnaby 07-10 • Fly Eu3 07-11 • Fly 05-07 • Hexagon Gtx 00 • Liberty 4T Eu3 Delivery 08 • Liberty 4T Eu3 07-08 • Liberty 4T Sport Eu306-08 • Liberty 4T 06-07 • liberty Moc 4T & Elle 09-12 • Liberty Rst Ptt 05-11 • Liberty Rst 04-05 • Liberty Sport 06 • Liberty 01-02 • Mp3 07-08 • Skipper 4T 00-02 • Super Hexagon Gtx 12 01-02 • Typhoon 4T 2V E3 10-11 • Vespa Et4 99-02 • Vespa Gt Eu3 06-07 • Vespa Gt 03-07 • Vespa Gts Eu3 07-11 • Vespa Gtv 4T Navy Eu3 08 • Vespa Gtv 07-08 • Vespa Lx 4T Eu3 Touring 10-11 • Vespa Lx 4T FL 09 • Vespa Lx Eu3 le 09-10 • Vespa Lx Eu3 06-08 • Vespa Lx 05-06 • Vespa Lxv 4T Eu3 06-09 • Vespa S 4T le & Colledge 09-11 • X Evo 07-11 V X7 Eu3 08 V X8 Premium Eu2-3 06-07 • X8 Street Eu2 06-07 • X8 04-06 • X9 Evolution Eu3 07 • X9 Evolution 03-06 • X9 01-02 • Zip 00-02 • Fly Eu3 08-11

150: Fly 05-07 • Liberty 4T Eu3 08 • Liberty 4T Sport Eu3 08 • Liberty Moc 4T 09-10 • Vespa Lx Eu3 ie 09-11 • Vespa Lx Eu3 06-08 • Vespa Lx Touring 10-11 • Vespa Lx 05-06 • Vespa S 4T ie & Colledge 09-11 • Vespa S 4T 08-09 • X8 Street Eu2 06-08

180: X9 Amalfi 00-03

200: Carnaby 07-08 • Liberty 4T Eu3 07-08 • Liberty 4T Sport Eu3 06-07 • Liberty Rst 04 • Liberty Sport 06 • Liberty 06 • Vespa GT 06-07 • X8 05-07 • X9 Evolution 03 • X9 02-03 (R.O. 82612R)



10 025 4740



KYMCO 50: Agility 4T Carry 11 • Agility 4T R12 07-08 • Agility 4T R16 08-12 • Agility R12 05 • Agility Rs 09 • Cx 93-97 • Dink 4T 07 • Dj 93-00 • Fever Zx 99-04 • K12 95-00 • Kb 95-00 • Like 4T 09 • Super 8 07 • Super 8 4T 09 • Vitality 4T 04 (R.O. 00106109)



BOCCOLE MESSA IN MOTO

STARTER BUSHES



10 025 1000 

50: MINARELLI - MBK - YAMAHA
(Conf. 5 Pz. - 5 Pcs. Pack)



10 025 1030 

PIAGGIO 50: Sfera Maquillage 2 • Sfera Rst Quartz • Ntt • Nrg • Nrg Rst Mc2 • Free FL Zip E Zip • Zip Base • Zip Rst v Zip Fast Rider Zip SP • Vespa Et2
GILERA 50: Typhoon • Storm • Easy Moving Spessore 4 mm - *Thickness 4 mm*
(Conf. 5 Pz. - 5 Pcs. Pack)
(R.O. 433862)



10 025 1050 

PIAGGIO 50: Diesis 01 • Free Delivery 00-01 Fly 2T/4T • Liberty 2t RST • 4t RST 04 • Liberty 97-02 • 4T 00-02 • NRG Extreme 99-00 RST Mc2 96-98 • Mc3 01-02 • Purejet 02-04 Vespa Et2 97-01 • Et2 iniezione 97-00 • Et4 00-02 • Zip Rst 96-99 • Sp 01-04 • Euro 1 00-02 • 4T 00-04
PIAGGIO 100: Free 02-03
GILERA 50: Dna 00-02 • Dna GP Experience 03-04 • Ice 01 • Runner Poggiali • FL • Purejet 97-02 • Stalker 97-04 • Typhoon XR 00 Typhoon 01-04 • (Conf. 5 Pz. - 5 Pcs. Pack)
(R.O. 479866)



10 025 1010 

FORO INTERNO Ø 15 MM
INTERNAL HOLE Ø 15 MM
PIAGGIO 125: Vespa Et4 • Sfera Rst Liberty 98 • Hexagon Lx4
(Conf. 5 Pz. - 5 Pcs. Pack)
(R.O. 435027)



10 025 1020 

FORO INTERNO Ø 17 MM
INTERNAL HOLE Ø 17 MM
PIAGGIO 125-150: Skipper 94-97 • Skipper Lx 98-99 • Hexagon Lx • Lxt 98-99 • Hexagon 94-97 • Vespa Et4 99-01
GILERA 125: Typhoon 95-98 • Typhoon X Xr 99-00 • Runner Fx
125-180: Fxr 97-00
(Conf. 5 Pz. - 5 Pcs. Pack)
(R.O. 478032)



10 025 1040 

PER POMPA MIKUNI - FOR MIKUNI PUMP
PEUGEOT 50: Buxy 94-97 • Eliseo 99 Elystar TSDI 03 • Looxor 01-02 • TSDI 02 Metal X 02 • Speedake 95-97 • Speedfight aria • Kat acqua 97-99 • Squab 95-97 • Vivacity 99 • Kat 99-02 • Serie speciali 02 • Trekker 98-00 • Zenith L 94-96 • LN • LS-N 97-98 • X-Fight 00 • X race 03
100: Elyseo 99-01 • Looxor 01 • SVL 98 • Speedfight 97-00 • Trekker 98 • Vivacity 99-01 • X Fight 00-01
(Conf. 5 Pz. - 5 Pcs. Pack)



10 025 0393 

INGRANAGGIO MESSA IN MOTO
Z12 Foro 20,5 mm
KICK STARTER GEAR - Z12 Hole 20,5 mm
PIAGGIO: Vespa Px 125-150-200 • T5 • Rally 200 VNX - VLX - VSX - VNX5T - VSE1
(R.O. 113256)



10 025 0403 

INGRANAGGIO MESSA IN MOTO
Z12 Foro 21,8 mm
KICK STARTER GEAR - Z12 Hole 21,8 mm
PIAGGIO: Vespa Px 125-150 Sprint • Gtr • Super VNX - VLX - VSX - VLB
(R.O. 089229)



10 025 0413 

INGRANAGGIO MESSA IN MOTO
Z12-13 Foro 22 mm
KICK STARTER GEAR - Z12-13 Hole 22 mm
PIAGGIO: Vespa 125-150 Super 66-79 • P150 S VNB - VNT - VNS
(R.O. 058680)





BOCCOLE MESSA IN MOTO

STARTER BUSHES

12 193 0010



MOLLA MESSA IN MOTO - STARTER SPRING
PIAGGIO - GILERA: Scooter 50
(Conf. 5 Pz. - 5 Pcs. Pack)
(R.O. 289495)



12 193 0020



MOLLA MESSA IN MOTO - STARTER SPRING
MINARELLI - MBK - YAMAHA: Scooter 50
(Conf. 5 Pz. - 5 Pcs. Pack)
(R.O. 905083260900)



12 193 0030



MOLLA PIGNONE SCORREV. MESSA IN MOTO
STARTER PINION SPRING
MINARELLI - MBK - YAMAHA:
Scooter 50 - (Conf. 10 Pz. - 10 Pcs. Pack)
(R.O. 3VLE56730000)



12 193 0050



MOLLA MESSA IN MOTO - STARTER SPRING
PIAGGIO: Vespa Px 125-150-200 -T5-Pxe 125-150-200 - VNX-VLX-VBX-VNX5T-VNX2-VLX2-VSX1-VLA-VLB-VBC- (R.O. 47218)



12 193 0060



MOLLA MESSA IN MOTO - STARTER SPRING
PIAGGIO: Vespa 50-90-125 Primavera -Et3 V5A1-V5B1-V5B2-V5SA1-V9A1-VMA2-VMB1-VMX1T - (R.O. 78478)



12 193 0070



MOLLA - SPRING
PIAGGIO: Vespa px 125-150-200 -t5-pxe 125-150-200 - VNX-VLX-VBX-VNX5T-VNX2-VLX2-VSX1-VLA-VLB-VBC- (R.O. 139100)



12 187 0060



BUSSOLA ALBERO MESSA IN MOTO
BUSH FOR STARTER SHAFT
50: MALAGUTI - MINARELLI - MBK - YAMAHA
(R.O. 903801524000)





12 153 0010 

BENELLI 50: 491 Gt 98-99 • Pepe 99-01 • K2-Lc 98-01
MALAGUTI 50: Centro Base 93-94 • Centro SL 94-98 • Ciak 99-00 • F10 Rst Eu1 Eu2 01-03 • F12 Phantom 94-98 • F15 Fire Fox 96-98 • Yesterday • Yesterday Euro 97-00 (R.O.08100903)
MBK 50: Booster Track 96-98 • Evolis 92-95 • Fizz 94-95 • Forte 94-96
YAMAHA 50: Bw'S Bump 97-98 • Axis 95-96 • Breeze 94-95
Nera - Black



12 153 0011 

BENELLI 50: 491 Gt 98-99 • Pepe 99-01 • K2-Lc 98-01
MALAGUTI 50: Centro Base 93-94 • Centro SL 94-98 • Ciak 99-00 • F10 Rst Eu1 • Eu2 01-03 • F12 Phantom 94-98 • F15 Fire Fox 96-98 • Yesterday • Yesterday Euro 97-00 (R.O.08100903)
MBK 50: Booster Track 96-98 • Evolis 92-95 • Fizz 94-95 • Forte 94-96
YAMAHA 50: Bw'S Bump 97-98 • Axis 95-96 • Breeze 94-95
Cromato - Chrome plated



12 153 0020 

MBK 50: Booster Rocket 97-98 • Booster Spirit 96-98 • Booster Ng 95-98 • Nitro 97-98
YAMAHA 50: Bw'S Next Generation 97-98 • Bw'S Original 97-98 • Spy 95-98 • Aerox 97-98 (R.O.3VLE56200100)
Nera - Black



12 153 0021 

MBK 50: Booster Rocket 97-98 • Booster Spirit 96-98 • Booster Ng 95-98 • Nitro 97-98
YAMAHA 50: Bw'S Next Generation 97-98 • Bw'S Original 97-98 • Spy 95-98 • Aerox 97-98 (R.O.3VLE56200100)
Cromato - Chrome plated



12 153 0030 

PEUGEOT 50: Buxy 94-97 • Speedake 95-97 • Speedfight Ac-Lc 97-98 • Sv Geo 91-95 • Zenith L 94-96
100: Elyseo 99-01 • Speedfight 97-00 • Sv L 98 • Vivacity 99-01 • X-Fight 00-01 (R.O.723494)
Nera - Black



12 153 0040 

DERBI 50: Atlantis 02 • Boulevard 2T-4T 09 • Gp1 01-03
GILERA 50: Dna 00-07 • Easy Moving 95-96 • Ice 01-05 • Runner 97-00 • Stalker 97-09 • Storm Eu2 07 • Typhoon 94-97 (R.O.286214)
125: Runner Fx-Fxr 97-02 • Typhoon 95-98
PIAGGIO 50: Diesis 01 • Fly 2T-4T 05-07 • Free 92-94 • Liberty 97-05 • Liberty 4T 00-08 • Nrg 94-96 • Quartz 92-96 • Sfera 91-93 • Typhoon 01-09 • Zip 92-04
100: Fly 4T 06-08 • Free 02-03 • Zip 4T 06-08
125: Skipper 94-97 (R.O.286214)
Nera - Black



12 153 0041 

DERBI 50: Atlantis 02 • Boulevard 2T-4T 09 • Gp1 01-03
GILERA 50: Dna 00-07 • Easy Moving 95-96 • Ice 01-05 • Runner 97-00 • Stalker 97-09 • Storm Eu2 07 • Typhoon 94-97 (R.O.286214)
125: Runner Fx-Fxr 97-02 • Typhoon 95-98
PIAGGIO 50: Diesis 01 • Fly 2T-4T 05-07 • Free 92-94 • Liberty 97-05 • Liberty 4T 00-08 • Nrg 94-96 • Quartz 92-96 • Sfera 91-93 • Typhoon 01-09 • Zip 92-04
100: Fly 4T 06-08 • Free 02-03 • Zip 4T 06-08
125: Skipper 94-97 (R.O.286214)
Cromato - Chrome plated



12 153 0100 

APRILIA 50: Gulliver 95-98 • Rally 95-03 • Area 51 98-00 • Gulliver Lc 96-98 • Rally Lc 96-99 • Scarabeo 93-05 • Sonic 98-07 • Sr 94-96 • Sr Lc 94-96 (R.O.AP8235073)
Alluminio - Aluminium





PEDIVELLE AVVIAMENTO

KICK STARTER LEVERS

12 153 0050



PIAGGIO: Vespa 50-90-125 • 125 Primavera • ET3
V5A1-V5B1-V5SA1-V9A1-VMA2
(R.O. 079077)

Alluminio - Aluminium



12 153 0060



PIAGGIO: Vespa 50-125 Pk - Rush - N - Pk XL 125
V5X1T-VMX1T-VMX5T-V5X5-V5X4
(R.O. 2161415)

Alluminio - Aluminium



12 153 0070



PIAGGIO: Vespa Px 125-150 • Pe 200 - Pxe
Arcobaleno • Cosa 125-150-200
VNX-VLX-VBX-VNX2-VLX2-VSX1-VLR1T-VLR-VSR1
(R.O. 1743125)

Alluminio - Aluminium



12 153 0080



PIAGGIO 50: Vespa Et2 97-05 • Vespa Et2
Iniezione 97-00 • Vespa Et4 00-05 • Vespa Lx 2T
05-08 • Vespa S 4T-4V 08-09
(R.O.969421)

Alluminio - Aluminium



12 153 0090



PIAGGIO 125: Vespa Et4
(R.O. 479133)

Alluminio - Aluminium



12 153 0170



PIAGGIO: Vespa 150 GL • Sprint • Super
Sprint Veloce
VLB-VLA-VBC
(R.O. 174310)

Alluminio - Aluminium



12 153 0180



PIAGGIO: Vespa 125-150 59
VNB1/2-VBB-VBA1T
(R.O. 083986)

Alluminio - Aluminium



12 153 0210



COPPIA PEDIVELLE - RH + LH LEVERS

PIAGGIO: Ciao
(R.O. 180888/9)





APRILIA

10 030 0240 

150-200: Scarabeo 4T



10 030 0300 

125: Atlantic 03-05 • Scarabeo 04-06 • Sport City 06-08 • **250:** Sport City Cube 08-12
300: Sport City Street 12 • Atlantic 10-11 • Scarabeo Light 09-10 • Sr Max 11-14 • **400:** Atlantic Sprint 05-08 • Scarabeo Light 06-08 • **500:** Atlantic 01-04 • Scarabeo 03-06 (R.O. 8494905)



10 030 0400 

125: SR Max 11-14 • Sport City 06-08 • Atlantic 06-08
250: Atlantic Eu3 06-08 • Sport City Cube 08-12 • Scarabeo Light 06-08 (R.O. 8477975)



DERBI

10 030 0300 

300: Rambla 10-11 (R.O. 8494905)



10 030 0400 

125: Rambla 08-09
250: GP1 Low Seat Eu3 07-08 • Rambla 08-09 • (R.O. 8477975)



GILERA

10 030 0300 

250: Oregon 06-10
300: Nexus Eu 3 08-11
500: Fuoco Eu3 07-14 • Nexus 06-11 (R.O. 8494905)



10 030 0400 

125: Nexus Eu3 ie 08-10
250: Nexus Eu3 06-07 • Nexus SP Eu3 06-07 (R.O. 8477975)



HONDA

10 030 0260 

125: Pantheon Fes 04-05 • Silver Wing Fes 07-12 • Pes 06-08 • Sh 05-12
150: Pantheon Fes 03-05 • Sh 05-12 (R.O. 31110-KRJ-901)



10 030 0290 

250: Foresight 98-02 • Foresight 05 (R.O. 31110-KFG-008)





RUOTE LIBERE AVVIAMENTO

STARTER WHEELS

KYMCO

10 030 0260



125: G-Dink 12
200: Dink Eu3 i 06-07 • Downtown 10 • People Gti 10-14
250: People S-Si 06-07 • X Citing i 05-07 •
300: Downtown 09-11 • G-Dink 12 • K-Xct 12-14 • Maxxer 05-06 • Mxu 05-10 • People Gti 10-14 • People Si 08 • X-Citing 08-09
350: Downtown 15-16
 (R.O. 0126013)



10 030 0280



125: Agility Carry 11 • Agility plus 14-16 • Agility R16 08-12 • Agility Rs 09 • Heroism 95-97 • Like 09-12 • Mxer 02-03 • People One 13-16 • Agility 4T 06-08 • Movie 99-04 • People 99-11 • People S 05-08 • Super 8 08-09 • Vivio 00 • Zing 97-98
150: Agility R16 08-09 • Heroism 95-97 • Vivio 00 • Zing 97-98 • Mxer 04 • Mxu 05-06
200: Agility R16 10-12 • Agility Plus 14-16 • Like 09-12 • People S 05-07
 (R.O. 00128248 • 00128742)



10 030 0290



200: Dink Classic 04 • Dink Eu 3 i 06-07 (71001292>)
250: Bew/Eu2 00-03 • Grand Dink Eu2 01-04 • KXR 03-04 • MXU 05 • People Lc 03-04 • Yup 03
300: Maxxer 05-06 (Vin 61100480 >) • Mxu 05-06 (>61000532)
 (R.O. 00128935)



MBK

10 030 0010



50: Cs Mack G 02-04 • Cw Booster 90-95 • Cw Booster Naked 03 • Cw Booster Spirit 99-03 • Cw L Booster 01-03 • Cw Rs Booster Ng 99-03 • Cw Booster Rocket 97-98 • Cw Booster Track 96-02 • Ew Stunt 00-02 • Ya R Forte 94-96 • Ye Evolis 92-95 • Yh Flipper 99-04 • Ym Fizz 94-95 • Yn R Ovetto 02-04 • Yq Nitro 97-04
 (R.O. 3VL155700000)



10 030 0230



125: Flame • Flame R 95-99 • Doodo 00-01 • Thunder 01-02 • Skyliner 98-02
150: Doodo 01-02 • Thunder 01-02 • Skyliner 00-02
 (R.O. 5NSE55700000)



10 030 0270



250: Skyliner 00-03 • Abs 03
300: Kilibre 03
 (R.O. 4HC155900200)



10 030 0390



125-180: Skyliner 03
 (R.O. 5XME55700000)





PIAGGIO

10 030 0300 

250: Beverly Rst 04-05 • Vespa Gts 05-12 • X9 06 • **300:** Beverly Rst 4T 4V 10-15 • Beverly Tourer 09-10 • Carnaby Cruiser 09-12 • Mp3 10-14 • Vespa Gts 08-16 • Vespa Gtv 10-13 • X7 Evo 09-10 • **350:** Beverly 4T 4V 11-14 • X10 4T 4V 12-15 • **400:** Beverly 06-10 • Mp3 07-11 • X Evo 07-11 • X8 06-08 • **500:** Beverly 02-12 • Mp3 11-16 • X10 4T 4V 12-14 • X9 01-02 • X9 Evolution 03-05
(R.O. 8494905)

10 030 0400 

125: Beverly Rst 4T 4V 10-15 • Mp3 08-12 • Vespa Gts 09-16 • X7 Evo 09-10
250: Beverly Cruiser 07-09 • Beverly Tourer 07-09 • Beverly 06-08 • Carnaby 08 • Mp3 06-09 • Vespa Gts 05-16 • Vespa Gtv 06-09 • X Evo 07-16 • X7 08 • X8 05-08
(R.O. 8477975)

10 030 0190 

Ciao
Ruota Libera Z 18 - *Freewheel Z 18*
(R.O. 103631)

10 030 0200 

Bravo • SI
Ruota Libera 16 - *Freewheel Z 16*
(R.O. 114531)



SUZUKI

10 030 0290 

200: Burgman 07-14
250: Burgman 98-06

10 030 0330 

125: Epicuro 99-01 • Burgman 02-06 • Sixteen 08-11 • **150:** Epicuro 99-01 • Burgman 02-06 • Sixteen 08-11

10 030 0370 

400: Burgman X-K6 99-06



10 030 0380 

400: Burgman 07-15





RUOTE LIBERE AVVIAMENTO

STARTER WHEELS

YAMAHA

10 030 0010



50: Bw's Bump 97-98 • Bw's Naked 03-16 • Bw's Next Generation 97-06 • Bw's Original 97-02 • Bw's 04-16 • Cs Jog R 02-15 • Cw Bw's 95-04 • Ns Aerox 13-16 • Yh Why 99-06 • Yn Neo's 97-16 • Yq Aerox 97-12



10 030 0230



125: Beluga 90-95 • Cygnus 95-98 • Teo's 00 • Maxster 01-02 • Majesty 98-02

150: Flyone 90-95 • Teo's 01-02 • Maxster 01-02 • Majesty 00-02
(R.O. 5NSE55700000)



10 030 0250



125: Yp X • City 08-11 • Yp R X Max 06-16
(R.O. 1B9E55800000)



10 030 0270



250: X City 07-15 • Majesty 96-03 • Yp R X Max 07-16
300: Versity 03-06
(R.O. 4HC155900200)



10 030 0310



400: Majesty 04-11 • Yp R X Max 13-16
(R.O. 5RU155900000)



10 030 0320



500: Xp T Max 01-11 • **530:** Xp T Max 12-14
1200: Xtz Super Tenere 10-11
1300: Fjr A Abs 06-11 • Fjr A 03-05 • Fjr As 06-08 • Fjr 01-04 • Xvs A Midnight Star 07-08 • Xvz Royal Star 96-00 • Xvz Tf Royal Star Venture 00
1700: V Max 09-10
(R.O. 5NK155900000)



10 030 0390



125: Majesty 03-09
180: Majesty 03-06
(R.O. 5XME55700000)





KYMCO

10 031 0010

125: Agility 4T Eu3 06-08 • Agility 4T 06 • Movie Eu3 06-07

125-150: Movie XL Eu2 03-04 • Movie XL 01 • Movie 99-00 • People Eu2 03 • People 99-00 • People Eu3 07-11 • People S DD Eu3 07-08 • People S 05 • Super 8 08-09 • Vivio 00

150: Movie Eu3 06-07

Mixer Eu2 04

Mxu 05-06

200:

People Si 07

People S 05

(R.O. 00128792)

(R.O. 0128730)

(R.O. 0128728)



10 031 0020

250: B&w Eu2 03 • B&w 00 • Grand Dink Eu2 03-04 • Grand Dink 01-02 • Kxr 03-04 • Mxu 05 •

People Lc 03-04 • Yup 03

300: Maxxer Vin 61100480 > 05-06

MXU > 6100052 05-06

(R.O. 00128935 • 00128933)



MBK

10 031 0070

250: X City 07-15 • Majesty 96-03

• Yp R X Max 07-16

300: Versity 03-06

(R.O. 4HC155900200 • 4HC155170000)



10 031 0120

125: Xc Flame F 00 • Xck Flame R 96-99

• Xct Flame 95-99

(R.O. 5NSE55700000 • 4CWE55240100)



SUZUKI

10 031 0040

125-150: Sixteen 08-11

(R.O. 12649-20E02-00 • 12601-20841-000)



10 031 0060

400: Burgman 99-06

(R.O. 12600-15824-000)





KIT RUOTE LIBERE AVVIAMENTO CON INGRANAGGIO

STARTER WHEELS AND GEAR KITS

YAMAHA

10 031 0070



250: X City 07-11 • Majesty 96-03 • Dx 98-99 •
Abs 03 • Black X Max 09 • X Max 05-11 • X Max
Abs/Sport 11 - **300:** Versity 03-06
(R.O. 4HC155900200 • 1COE55170000)



10 031 0110



125: Nxc Cygnus X 04-11
(R.O. 5TYE55240000 • 5TYE55700100)



10 031 0120



125: Xc Cygnus R 99-03 • Xck Cygnus R 97-03
Xct Cygnus 95-98
(R.O. 4CVE552400100 • 4CVE55700000)



10 031 0090



500: Xp T Max 01-11 • **530:** Xp T Max 12-16
(R.O. 5NK155900000 • 5GJ155170000)



10 031 0100



125: Vp X City 08-11 • Yp R X Max 06-16
(R.O. 1B9E55800000 • 5YPE55240000)



12 191 0060 

SET 6 MOLLE FRIZIONE
6 CLUTCH SPRINGS SET
YAMAHA 500: T-Max 01-07
 (R.O. 5GJ1653910)

12 191 0070 

SET 6 MOLLE FRIZIONE
6 CLUTCH SPRINGS SET
YAMAHA: T-Max 08-11
 (R.O. 4B51653900)

12 191 0080 

SET 6 MOLLE FRIZIONE
6 CLUTCH SPRINGS SET
YAMAHA 530: T-Max 12-14
 (R.O. 59C1653900)

12 195 0120 

MOLLA FRIZIONE - CLUTCH SPRING
PIAGGIO 50-90-125: Vespa Primavera • Et3
 V5A1•V5B1•V5B2•V9A1•VMA2•VMB1•VMX1T
 (R.O. 112390)

12 195 0140 

MOLLA FRIZIONE - CLUTCH SPRING
PIAGGIO 125-150-200: Vespa Px -T5-Pxe-Cosa
 VNX-VLX-VBX-VNX5T-VNX2-VLX2-VSX1-VLA-
 VLB-VBC-VNR-VLR-VSR
 (R.O. 022821)

10 030 0070 

DISCO INTERNO FRIZIONE
CLUTCH INTERNAL DISC
PIAGGIO: Vespa Px 125 E • Px 150 E
 (R.O. 094425)

10 028 0100 

SERIE 11 DISCHI FRIZIONE
7 CLUTCH DISCS SET
YAMAHA 500: T-Max 01-11

10 028 0110 

SERIE 13 DISCHI FRIZIONE - 13 CLUTCH DISCS SET
YAMAHA 530: T Max 12-14

10 030 0050 

KIT PARASTRAPPI TRASMISSIONE PRIMARIA
PRIMARY DRIVE KIT
PIAGGIO: Vespa Px 125 • Px 150
 (R.O. 077370-077371- 078853)

10 030 0060 

KIT PARASTRAPPI TRASMISSIONE PRIMARIA
PRIMARY DRIVE KIT
PIAGGIO: Vespa Px 200 E
 (R.O. 077370-077371-078853-077372)

10 030 0080 

KIT PARASTRAPPI TRASMISSIONE PRIMARIA
PRIMARY DRIVE KIT
PIAGGIO 50: Vespa • Vespa Pk
90: Vespa • **125:** Vespa Primavera • Pk
 V5A1-V5B1-V5B2-V9A1-VMA2-VMB1-V5X1T-VMX1T
 (R.O. 154625)





FRIZIONI - TRASMISSIONI PRIMARIE

CLUTCHES - PRIMARY DRIVES



10 024 0130 

COPPIA INGRANAGGI TRASMISSIONE PRIMARIA DENTI ELICOIDALI (Z 22-63)
PRIMARY DRIVE GEARS HELICOIDAL TEETH (Z 22-63)

PIAGGIO: Vespa 50-90 - 50 Pk

10 024 0140 

COPPIA INGRANAGGI TRASMISSIONE PRIMARIA DENTI ELICOIDALI (Z 24-61)
PRIMARY DRIVE GEARS HELICOIDAL TEETH (Z 24-61)

PIAGGIO: Vespa 50-90 • Et3 • 125 Pk

10 024 0150 

COPPIA INGRANAGGI TRASMISSIONE PRIMARIA DENTI DRITTI (Z 24-72)
PRIMARY DRIVE GEARS STRAIGHT TEETH (Z 24-72)

PIAGGIO: Vespa 50-90 • 50 Pk

10 024 0160 

COPPIA INGRANAGGI TRASMISSIONE PRIMARIA DENTI DRITTI (Z 27-69)
PRIMARY DRIVE GEARS STRAIGHT TEETH (Z 27-69)

PIAGGIO: Vespa 125 • ET3 • 125 PK

10 024 0170 

COPPIA INGRANAGGI TRASMISSIONE PRIMARIA DENTI ELICOIDALI (Z 18-67) SENZA PARASTRAPPI
PRIMARY DRIVE GEARS HELICOIDAL TEETH (Z 18-67) WITHOUT SHOCK ABSORBER SPRINGS

PIAGGIO: Vespa 50 denti elicoidali Z 18-67

10 026 0130 

CAMPANA FRIZIONE - CLUTCH BOX

PIAGGIO: Vespa Px 125 E • Px 150 E • 150 Sprint-150 GL • (R.O. 059369)

10 026 0140 

CAMPANA FRIZIONE - CLUTCH BOX

PIAGGIO: Cosa CL-CLX 150-200 88-91
Vespa Px T5 125 85-89
Vespa PxeArcobaleno 200 81-97 • Rally 200 (R.O. 2458295)

10 026 0100 

MOZZETTO FRIZIONE

CLUTCH SPIDER
PIAGGIO: Vespa 50-90-125 Pk • Ape 50 Tm • P (R.O. 2/79497)

10 026 0230 



Tipo originale - *Original Type*

Tattamento ad Induzione - *Induction Treatment*

10 026 0240 



Tipo originale - *Original Type*

Tattamento ad Induzione - *Induction Treatment*



10 026 0253 



BOCCOLA FRIZIONE - CLUTCH BUSH

PIAGGIO 200: Vespa Pe - Rally - Cosa (R.O. 159853)





10 030 0430 

RALLINO FRIZIONE - PUSH ROAD CLUTCH
PIAGGIO: Vespa 50
(R.O. 078453)



10 030 0440 

RALLINO FRIZIONE - PUSH ROAD CLUTCH
PIAGGIO: Vespa Primavera 125
(R.O. 165019)



10 030 0460 

RALLINO FRIZIONE - PUSH ROAD CLUTCH
PIAGGIO: Vespa Px-Gl-Sprint-Super
Vla-Vlb-Vbc-Vnx-Vlx-Vbx
(R.O. 089858)



10 030 0040 

PIATTELLO CON MOLLA RALLINO FRIZIONE
ACTUATING PLATE FOR CLUTCH
PIAGGIO: Ape Mp
(R.O. 131899 - 110957 - 131900)

10 030 0180 

PIAGGIO: Vespa 50 Sp./Et3 • Pk • Pk XL • Rush
(R.O. 016821 - 014457 - 165019)



10 030 0161 

PIATTELLO CON MOLLA RALLINO FRIZIONE
ACTUATING PLATE FOR CLUTCH
PIAGGIO: Vespa Px 125 • Px 150 • GL Sprint
Super • Vnx • Vlx • Vlb • VLa • Vbc
(R.O. 016821 - 014457 - 2/89858)



10 030 0171 

PIATTELLO CON MOLLA RALLINO FRIZIONE
ACTUATING PLATE FOR CLUTCH
PIAGGIO: Vespa Pe 200 • Vsx • Vsx2
Made in Taiwan
(R.O. 025026 - 014457 - 2/89858)



10 036 0260 

SERIE MASSETTE FRIZIONE AVVIAMENTO
STARTER CLUTCH SET WITH AUTOMATIC SPEED
(3 pz - 3 Pcs).
PIAGGIO: Ciao • Bravo • Si • Superbravo • Grillo
s/variatore - *Without variator*
(R.O. 249813)



10 026 0120 

CAMPANA INTERNA
INTERNAL DRUM CLUTCH
PIAGGIO: Ciao • Si
(R.O. 2/114943)



10 030 0450 

LEVETTA FRIZIONE - CLUTCH LEVER
PIAGGIO: Vespa GL • Px
(R.O. 083806)



12 189 0070 

MOLLA FRIZIONE MASSETTE AVVIAMENTO
STARTER SET SPRING
PIAGGIO: Ciao • Si • Grillo • Bravo 2
Conf. 50 Pcs. - 50 Pcs bag
(R.O. 121753)

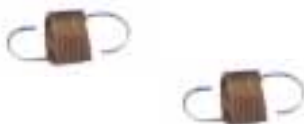

12 195 0130 

MOLLA MASSETTE FRIZIONE
CLUTCH SPRING
PIAGGIO: Ciao • Si • Grillo • Bravo 2
Conf. 50 Pcs. - 50 Pcs bag
(R.O. 121537)

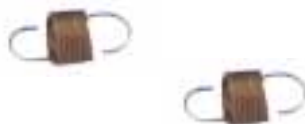



CROCERE E INGRANAGGI CAMBIO

GEAR SELECTOR AND SLIDING

10 022 0020



CROCERA INNESTO MARCE
GEAR SELECTOR

PIAGGIO 50: Pk XL 85-88 • Ape FL • FL2 85-95
Ape FL • FL2 85-95 • Ape FL3 Europa 96-98
50-90: FL • 50 (91-97)-FL 125 89
50-125: Vespa 67-96 • Pk 82-84
(R.O. 134902)



10 022 0100



CROCERA INNESTO MARCE MM 5,5
GEAR SELECTOR MM 5,5

PIAGGIO 150: Vespa Px
Pe Serie Arcobaleno
Sprint
(R.O. 130939)



10 022 0110



CROCERA INNESTO 4 MARCE
SELECTOR 4 GEARS

PIAGGIO 50-250: Ape 74-78
50: Vespa 50 Special
90: SS
125: Primavera Et3
(R.O. 111589)



10 022 0120



CROCERA INNESTO 3 MARCE
SELECTOR 3 GEARS

PIAGGIO 50-90: Vespa 78-80
(R.O. 165304)



10 024 0060



INGRANAGGIO INVERTITORE
INVERTER GEAR

Z 20 / 12 - ASSE-AXLE Ø 20 / 22
PIAGGIO: Ape car P2-P3 (78-85)
Ape Mp P501-P601 (78-96)
Ape Tm P602 (82-83)
(R.O. 169744)



10 024 0080



INGRANAGGIO SCORREVOLE Z 21
SLIDING GEAR Z 21

PIAGGIO: Ape car P2/P3 (78-85)
Ape Mp P501-P601
(78-96) • Ape Tm P602 (82-83)
(R.O. 118909)





10 022 1000 

PRESELETTORE CAMBIO

GEAR BOX SELECTOR

PIAGGIO 150: Vespa GL•Sprint•VLA•VLB • VLC
(R.O. 092167)



10 022 1010 

PRESELETTORE CAMBIO

GEAR BOX SELECTOR

PIAGGIO 125: Vespa Px
150: Vespa Px • Vespa Ps
200: Vespa Px
VNX•VLX•VSX•VBX1T
(R.O. 138880)



10 022 1020 

PRESELETTORE CAMBIO CON SPIA A FOLLE

GEAR BOX SELECTOR WITH NEUTRAL INDICATOR

PIAGGIO 125: Vespa Px • Cosa
150: Vespa Px • Cosa
200: Vespa Px Arcobaleno • Cosa
VNX2T•VLX1T•VXS1T•VNR1T
(R.O. 199803)



10 022 1030 

PRESELETTORE CAMBIO

GEAR BOX SELECTOR

PIAGGIO 125-150-200: Vespa Px
VNX2T•VLX1T•VXS1T
(R.O. 196585)



14 258 0110 

14 258 0113 



COPRISELETTORE CROMATO

GEAR BOX CHROMED COVER

PIAGGIO: Vespa Px • Pe • Vnx • VLx • Vsx • Vnx2
VLx2 • Vsx2





TRASMISSIONE APE

APE TRANSMISSION



12 183 0160 

12 183 0163 

GIUNTO ELASTICO - *COUPLING*

Ape Car P2-P3 78-85 • Car Max Diesel 86-96
Tmp 703 • P703V 84-99 • Tmp703
P703V Diesel 87-98
(R.O.228302)

12 183 0170 

GIUNTO ELASTICO - *COUPLING*

PIAGGIO 420: Ape Poker Benzina 93
Fori fissaggio \varnothing 10 - *Fixing holes \varnothing 10*
(R.O.226345)

12 183 0250 

GIUNTO ELASTICO - *COUPLING*

Poker benzina Diesel 93-97
Porter Quargo 05
Fori fissaggio \varnothing 12 - *Fixing holes \varnothing 12*
(R.O.268253)

12 183 0180 

CUFFIA TENUTA OLIO SEMIASSE APE P 50 *SHAFT PROTECTION*

50: FL • FL 2 89-95 • 50 FL3 Europa 96-98
Rst Mix 50 99
(R.O.119989)



12 183 0190 

CUFFIA TENUTA OLIO SEMIASSE APE MP-CAR *SHAFT PROTECTION*

Car P2-P3 78-85 • Mp P501 • P601 78-96
Tm P602 82-83 • Tmp 703P 703V 84-99
(R.O.198618)





10 024 0090

KIT ALBERO RUOTA POSTERIORE
REAR WHEEL SHAFT KIT

GILERA 50: Easy Moving • Storm • Typhoon
PIAGGIO 50: Free • Free FL • Nrg Rst • Ntt •
Quartz 50 • Sfera • Sfera Rst • Sfera Maquillage
2 • Zip • Zip 95 • Zip Fast Rider • Zip e Zip
Nrg Rst Mc2 96-97q
80: Skr City • Sfera
(Albero R.O. 478155 - Scodellino R.O. 194423)
(Dado R.O. 194424 - Copiglia R.O. 012789)



10 024 0110

KIT ALBERO RUOTA POSTERIORE
REAR WHEEL SHAFT KIT

GILERA 50: Runner Runner D. Disco 97-00
Stalker • Stalker Doppio Disco 97-00
PIAGGIO 50: Liberty • Vespa Et2 • Vespa Et2
Iniez. • Zip Fast Rider Rst • Zip Freno a Disco Rst
Zip Rst • Zip Sp • Nrg RST Mc2 98
(Albero R.O. 480053 - Scodellino R.O. 194423)
(Dado R.O. 194424 - Copiglia R.O. 012789)

10 024 0050

ALBERO RUOTA POSTERIORE - REAR WHEEL AXLE

(Senza Ingranaggio - *Without gear*)

SCOOTER 50:

MOTORI MINARELLI • YAMAHA • APRILIA
MALAGUTI • MBK



10 024 0120

ALBERO SECONDARIO - DRIVEN SHAFT

PIAGGIO 125-150-200: Vespa Px E

Px T5 - Cosa 1 - Cosa 2

(R.O. 235908)



10 024 0193



ALBERO SECONDARIO - DRIVEN SHAFT

PIAGGIO 125-150-200: Vespa Px 81-97 • GL Sprint Super Rally 200

VNX - VLX - VSX - VLB1T - VNC1T - VNL1T - VSE1T

(R.O. 157800)





PARTICOLARI GOMMA MOTORE PIAGGIO

PIAGGIO RUBBER ENGINE PARTS

12 183 0060 

TAMPONE AMMORTIZZATORE
SHOCK ABSORBER RUBBER BUFFER

Vespa 50-125-Et3 • 50 Pk-125 Pk • Px • Pe
(R.O. 060536)



12 183 0130 

SUPPORTO ELASTICO X MARMITTA
RUBBER MUFFLER BRACKET

Ape 50 • FL2 • FL3 Eu • P
• Rst Mix Tmp
(R.O. 127350)



12 183 0200 

SUPPORTO ELASTICO MOTORE POST. APE
REAR RUBBER ENGINE MOUNTING

Mp Car-Car P2 • P3 78-85
Mp P501 • P601 78-96
(R.O.105976)



12 183 0270 

SUPPORTO MOTORE ANTIVIBRANTE
ENGINE MOUNT SILENTBLOCK

Vespa Primavera 50-90
(R.O. 112204)



12 183 0280 

12 183 0283 

SUPPORTO MOTORE ANTIVIBRANTE
ENGINE MOUNT SILENTBLOCK

Vespa Pe 200
(R.O. 174724)



12 183 0380 

TAMPONE DI SCANTRO
BUFFER

Vespa 50-90 • Primavera Et3
V5A1-V5B1-V5B2-V5SA1-V9A1-VMA2-VMB1
(R.O. 078578)



12 183 0390 

TAMPONE DI SCANTRO
BUFFER

Vespa Pk 50-125
V5X1T-V5X5T-V5S1T-VMX1T-VMX5T
(R.O. 165206)



12 183 0400 

TAMPONE DI SCANTRO
BUFFER

Vespa Px125-150 • P200E
VNX-VLX-VBX -T5 VNX5T
Vespa Pxe 125-150-200
VNX2-VLX2-VSX1
Vespa 150 GL • Sprint • Super
VLA-VLB-VBC
(R.O. 178338)



12 183 0510 

TAMPONE MOTORE
ENGINE BUFFER

Vespa Px 125-150
VNX1T-VLX1T
(R.O. 059589)



12 183 0520 

TAMPONE MOTORE
ENGINE BUFFER

Vespa Px 125-150
VNX1T-VLX1T
(R.O. 059588)



**12 183 0640****SILENTBLOCK**

Motori Piaggio: 50-125-150-200-250-300
For Piaggio Engines: 50-125-150-200-250-300
(R.O. 272750)

**12 183 0740****SILENTBLOCK**

50: Agility 2T R16 10-12 • Agility 4T Carry 11
Agility 4T R10 06-08 • Agility 4T R12 07-08
Agility 4T R16 08-12 • Agility Plus 2T -4T 14
Agility R12 05 • Agility Rs Naked 2T 10 • Agility
Rs 09 • B&w Eu2 03 • B&w 02 • Dink 4T 07 • Dink
Classic Eu2 03 • Dink Lc 98-02 • Filly Lx 01-02
Filly 98-00 • Heroism 95-97 • Like 2T 09 • Like 4T 09
Mxer Eu2 02-03 • People Eu2 03-11 • People S 4T
06-08 • People S 05-08 • People 99-04 • Sento 50
08 • Sniper Dd 93-96 • Super 8 2T 09 • Super 8 2T
13 • Super 8 4T 09 • Super 8 4T 13 • Super 8 07
Super 9 Sport Eu2 03-04 • Super 9 00 • Top Boy 97-
00 • Vitality 2T-4T 04 • Yup Eu2 03 • Yup 02
125: Agility 4T Eu3 06-08 • Agility 4T 06 • Agility
Carry 11 • Agility Plus 14 • Agility R16 08-12
Agility Rs 09 • B&w 125-150 00 • Dink Eu3 06-07
Dink 125-150 97-98 • Dink Classic 125-150 Eu2 03
Dink Classic 125-150 02 • Dink Lx 125-150 98-00
G-Dink 12 • Grand Dink 125-150 Eu2 01-04
Heroism 95-97 • Like Lx 12 • Like 09 • Movie Eu3
06-07 • Movie XL 125-150 Eu2 03-04

**12 183 0750****SILENTBLOCK**

50: Agility R12 05 • B&w Eu2 03 • B&w 02
Cx Super 94-97 • Cx 93 • Dink 50 4T 07 • Dink Classic
Eu2 03 • Dink Lc 98-02 • Dj W 94-00 • Dj X 91-92 • Dj
Y 93 • Fever Zx Eu2 03-04 • Fever Zx 99-00 • Filly Lx
01-02 • Filly 98-00 • Heroism 95-97 • K 12 95-00 • Kb
95-00 • Like 2T 09 • Mixer Eu2 04
Mxfr 02-03 • People Eu2 03 • People Eu2 08
People Eu2 11 • People S 4T 06-08 • People S 05-08 •
People 99-00 • People 04 • Sento 08 • Sniper Dd 94-
96 • Sniper 93 • Super 9 Sport Eu2 03 • Super 9 Sport
Eu2 04 • Super 9 00 • Top Boy 97-00 • Vitality 2T 04 •
Vitality 4T 04 • Yup Eu2 03 • Yup 02
125: Agility 4T 06 • Agility Plus 14 • Agility R16 09 •
B&w 125-150 Eu2 03-04 • B&w 125-150 00 • Dink
125 Eu3 06-07 • Dink 125-150 97-98 • Dink Classic
125-150 Eu2 03 • Dink Classic 125-150 02 • Dink Lx
125-150 98-00 • G-Dink 12 • Grand Dink 125-150
Eu2 03-04 • Grand Dink 125-150 01-02 • Heroism
95-97 • Movie 125 Eu3 06-07 • Movie XL 125-150 Eu2
03-04 • Movie XL 125-150 01 • Movie 99-00 • People
125-150 Eu2 03 • People 125-150 99-00 • People Eu3
07 • People Eu3 08 • People Eu3 11 • People S Dd Eu3
07-08 • People S 05 • Vivio 125-150 00
150: Heroism 95-97 • Movie 150 Eu3 06-07 •
200: Dink Classic 04 • Dink Eu3 I 06-07 • People S 07

**12 183 0760****SILENTBLOCK**

250: People Lc 03-04 • People S I 250 07-07 •
People S 06-06 • X Citing I 06-07 • X Citing 05-05
Yup 03-03 • **300:** G-Dink 12-12 • People S I 08-08
X Citing I R 08-08 • X Citing I R 09-09 • X Citing I 08-
08 • **400:** X Citing I Abs 14-14 • X Citing I Abs 15-15
X Citing I 13-13 • X Citing I 15-15

**12 183 0770****SILENTBLOCK**

125: Downtown I 09 • K-Xct I 12-14 • People Gti 10
200: Downtown I 10 • People Gti 10 • People Gti 14
250: B&w Eu2 03 • B&w 250 00 • Grand Dink Eu2
03-04 • Grand Dink 01-02 • **300:** Downtown I 09 •
Downtown Abs I 10-11 • Downtown I 11 • G-Dink
12 • K-Xct I Abs 14 • K-Xct I 12 • People Gti Abs 12-
14 • People Gti 10-14 • **350:** Downtown I Abs 15

**12 183 0780****SILENTBLOCK**

125: Downtown 09 • K-Xct I K-Xct I 12-14
People Gti 10 • **200:** Downtown I 10 • People Gti
10-14 • **250:** X Citing I 06-07 • X Citing 05
300: Downtown I 09-11 • Downtown Abs I 11 •
Downtown Abs 10 • K-Xct I Abs 12-14 • People
Gti Abs 12-14 • People Gti 10-14 • X Citing 300 I R
08-09 • **350:** Downtown I Abs 15 • **400:** X Citing I
Abs 14 • X Citing I Abs 13-15
500: X Citing R 05-09 • X Citing I R07-08 • X Citing
I 06-08 • **700:** Myroad I 11





CUFFIE - COPRIVENTOLA
CYLINDER COWLING - FLYWHEEL COVER

14 256 0110



CUFFIA MOTORE - CYLINDER COWLING

PIAGGIO 50: Vespa R • S • Special • Revival • N • FL • Pk 82-84 • Pk XL • XL Rush 85-88
(R.O. 139261)



14 256 0120



CUFFIA MOTORE - CYLINDER COWLING

PIAGGIO 200: Vespa Px • Vespa Px Arcobaleno • Cosa CL • CLX
180-200: Rally
(R.O. 431054)



14 256 0130



CUFFIA MOTORE - CYLINDER COWLING

PIAGGIO 125/150: Vespa Px-Pe Arcobaleno-Cosa / VNX-VLX--VNX2-VLX2-VLR1T-VLR-VLX1
(R.O. 843530-431056)



14 256 0160



CUFFIA MOTORE - CYLINDER COWLING

PIAGGIO 125: Vespa Et3 Primavera
(R.O.174702)



14 256 0010



CUFFIA MOTORE - CYLINDER COWLING

(Cilindro orizzontale - *Horizontal Cylinder*)
MINARELLI - YAMAHA - MBK 50
(R.O. 72105400)



14 256 0020



CUFFIA MOTORE - CYLINDER COWLING

(Cilindro verticale - *Vertical Cylinder*)
MINARELLI - YAMAHA - MBK 50
(R.O. 3VLE265100)



14 258 0010



CONVOGLIATORE - COPRIVOLANO

CONVEYOR - FLYWHEEL COVER
(Cilindro verticale - *Vertical Cylinder*)
MINARELLI - YAMAHA - MBK 50
(R.O. 3VLE265300)



14 258 0020



CONVOGLIATORE - COPRIVOLANO

CONVEYOR - FLYWHEEL COVER
(Cilindro orizzontale - *Horizontal Cylinder*)
MINARELLI - YAMAHA - MBK 50
(R.O. 72105100)





14 258 0091 

COPRIVENTOLA IN FERRO NERO
BLACK STEEL FLYWHEEL COVER
PIAGGIO: Vespa Pk-XL • Rush • N • FL •
Ape 50
(R.O. 244735)



14 258 0101 

COPRIVENTOLA IN FERRO NERO
BLACK STEEL FLYWHEEL COVER
PIAGGIO: Vespa Px • Pe
(Senza avv. elettrico - *Without electric starter*)
(R.O. 194362)



14 258 0100 

COPRIVENTOLA IN FERRO CROMATO
CHROMED STEEL FLYWHEEL COVER
PIAGGIO: Vespa Px • Pe
(Senza avv. elettrico - *Without electric starter*)
(R.O. 610236M)



14 258 0090 

COPRIVENTOLA IN FERRO CROMATO
CHROMED STEEL FLYWHEEL COVER
PIAGGIO: Vespa Pk • XL • Rush • N • FL •
Ape 50
(R.O. 244735)



14 258 0140 

COPRIVENTOLA IN FERRO NERO
BLACK STEEL FLYWHEEL COVER
PIAGGIO 50-90-125: Vespa Primavera
(R.O. 133658)





RMS

YOUR BEST PARTNER

▶ CATENE TRASMISSIONE

DRIVE CHAINS





In 35 anni di attività **KMC** è divenuta la più grande azienda produttrice di catene di trasmissione industriale e per motocicli ,offrendo prodotti di elevata qualità che soddisfano le esigenze del mercato sia come primo equipaggiamento che dell' aftermarket . Dopo anni di impegno e sforzi le fabbriche di **KMC** situate in Asia hanno ricevuto le certificazioni ISO-9001 e TS-16949.

Nelle proprie fabbriche **KMC** applica le più avanzate soluzioni tecniche ed utilizza i migliori materiali in commercio ,impegnandosi nel realizzare catene sempre più affidabili e che diano soddisfazione nella guida ai propri clienti.

***KMC** has become the leading chain manufacturer within the 35 years of operation. **KMC** offers products with superior quality, serving for global original equipment demands and aftermarket customer demands. With years of efforts, **KMC** now has factories in Asia with ISO-9001 & TS-16949 certificates. To achieve the most efficient production management, **KMC** practices the advanced engineering in its plants. **KMC** is committed to excel for creating the most reliable and joyful chain using experience for the customers.*

LEGENDA ICONE - ICONS DESCRIPTION



Catena dedicata all'utilizzo stradale
Designed for on - Road use



Catena dedicata all'utilizzo in fuoristrada
Designed for off-Road bikes



Catena sigillata con ORing a sezione circolare
Equipped with round-shaped seal



Catena sigillata con ORing con profilo a croce
Equipped with cross-shaped seal to enhance durability



Catena con particolare sistema di chiusura che aumenta la resistenza a fatica
Equipped with four-sides - riveting pins



Catena con maglie espressamente studiate a sezione maggiorata per una resistenza superiore a fatica
With heavier plates to increase tensile strength



Catena con rulli speciali ad alta resistenza
Equipped with solid bushing to upgrade fatigue resistance



Catena con perni ad alta resistenza
Equipped with specially processed pin to increase wear resistance



Catena con trattamento al nickel per le maglie
With silver-colored nickel plating and corrosion resistance



Catena con trattamento antiusura e frizione
Chain with special treatment for low friction

CATENE TRASMISSIONE - DRIVE CHAINS



CATENA DI TRASMISSIONE

KMC offre una gamma completa di catene di trasmissione per motociclette caratterizzate da alte prestazioni, elevata durata e accurata precisione dimensionale.

Il processo produttivo rigorosamente controllato garantisce che ogni componente soddisfi i più rigidi requisiti richiesti in campo motociclistico garantendo una qualità costante nel tempo oltre al miglior rapporto qualità / prezzo.

DRIVE CHAIN

KMC offers a full range of drive chains for motorcycles characterized by high-performance, high durability and precise dimensional accuracy. The strictly controlled manufacturing process ensures that every component meets the strictest requirements in motorcycle market, ensuring consistent quality over time and the best price / quality balance.

16 371 0130 	
MODELLO - MODEL	MAGLIE - LINKS
415H	130

16 371 9010 	
GIUNTO CATENA - CONNECTING LINK	
Con molletta - With clip	



16 371 0160 	
MODELLO - MODEL	MAGLIE - LINKS
415H	140

16 371 9010 	
GIUNTO CATENA - CONNECTING LINK	
Con molletta - With clip	



16 371 0150 	
MODELLO - MODEL	MAGLIE - LINKS
420H	120

16 371 9020 	
GIUNTO CATENA - CONNECTING LINK	
Con molletta - With clip	



16 371 0170	
MODELLO - MODEL	MAGLIE - LINKS
420H	140



16 371 9020
GIUNTO CATENA - CONNECTING LINK
Con molletta - <i>With clip</i>



16 371 0210	
MODELLO - MODEL	MAGLIE - LINKS
428H	140



16 371 9160
GIUNTO CATENA - CONNECTING LINK
Con molletta - <i>With clip</i>



16 371 0100	
MODELLO - MODEL	MAGLIE - LINKS
520H	120



16 371 9030
GIUNTO CATENA - CONNECTING LINK
Con molletta - <i>With clip</i>



16 371 0120	
MODELLO - MODEL	MAGLIE - LINKS
530H	120



16 371 9040
GIUNTO CATENA - CONNECTING LINK
Con molletta - <i>With clip</i>



CODICE RMS RMS CODE	CODICE KMC KMC CODE	P	W	D	T	T2	d	L	G	-	-
		PASSO PITCH	LARGHEZZA INTERNA ROLLER LINK WIDTH	DIAM. RULLO ROLLER DIAMETER	SPESSORE PIASTRINA EST. PIN LINK PLATE THICKNESS	SPESSORE PIASTRINA INT. ROLLER LINK PLATE THICKNESS	DIAM. PERNO PIN DIAMETER	LUNGHEZZA PERNO OVER-ALL WIDTH. RIV.	LUNGHEZZA PERNO GIUNTO OVER-ALL WIDTH. CON.	CARICO ROTTURA MINIMO MINIMUM TENSILE STRENGTH	CARICO ROTTURA MEDIO AVERAGE TENSILE STRENGTH
UNITÀ DI MISURA UNIT OF MEASURE		mm.	mm.	mm.	mm.	mm.	mm.	mm.	mm.	KGf	KGf
16 371 0130	415H	12,7	4,68	7,77	1,5	1,5	3,95	13,0	14,7	1810	1900
16 371 0160	415H	12,7	4,68	7,77	1,5	1,5	3,95	13,0	14,7	1810	1900
16 371 0150	420H	12,7	6,25	7,77	1,8	1,8	3,95	15,90	17,35	1840	2100
16 371 0170	420H	12,7	6,25	7,77	1,8	1,8	3,95	15,90	17,35	1840	2100
16 371 0210	428H	12,7	7,85	8,51	1,8	1,8	4,45	17,55	19,05	2180	2300
16 371 0100	520H	15,875	6,25	10,16	2,35	2,35	5,07	18,25	20,20	3100	3300
16 371 0120	530H	15,875	9,4	10,16	2,35	2,35	5,07	21,55	23,50	3100	3300

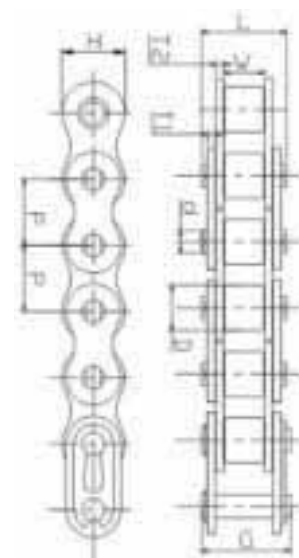

CATENE MOTOCROSS - MOTOCROSS CHAINS



CATENA MOTOCROSS

Catena per applicazioni off – road , prodotta con le migliori leghe d'acciaio e con esclusivi trattamenti termici che garantiscono una maggiore resistenza richiesta dalla guida in fuoristrada .

KMC , inoltre impiega speciali perni cromati e rullini ad alta resistenza che garantiscono un'usura minima ed elevato assorbimento degli shock caratteristici del motocross.

Queste qualità garantiscono al motociclista una guida fluida , divertente e sicura nel fuoristrada.

MOTOCROSS CHAIN

Chain for off – road applications , made from the best steel alloys and exclusive heat treatments guaranteeing greater strength required by off-road driving.

KMC also uses special chrome pins and rollers that ensure high strength , low consumption and high shocks absorption typical of motocross . These qualities provide to rider a smooth , fun and safe off-road ride .

16 371 0090	
MODELLO - MODEL	MAGLIE - LINKS
428DX	140

16 371 9120	
GIUNTO CATENA - CONNECTING LINK	
Con molletta - With clip	



16 371 0110	
MODELLO - MODEL	MAGLIE - LINKS
520DX	120

16 371 9130	
GIUNTO CATENA - CONNECTING LINK	
Con molletta - With clip	



CODICE RMS RMS CODE	CODICE KMC KMC CODE	P	W	D	T	T2	d	L	G	-	-
		PASSO PITCH	LARGHEZZA INTERNA ROLLER LINK WIDTH	DIAM. RULLO ROLLER DIAMETER	SPESORE PIASTRINA EST. PIN LINK PLATE THICKNESS	SPESORE PIASTRINA INT. ROLLER LINK PLATE THICKNESS	DIAM. PERNO PIN DIAMETER	LUNGHEZZA PERNO OVER-ALL WIDTH- RIV.	LUNGHEZZA PERNO GIUNTO OVER-ALL WIDTH- CON.	CARICO ROTTURA MINIMO MINIMUM TENSILE STRENGTH	CARICO ROTTURA MEDIO AVERAGE TENSILE STRENGTH
16 371 0090	428DX	12,7	7,85	8,51	2	2	4,51	18,80	20,00	2500	3000
16 371 0110	520DX	15,875	6,25	10,16	2	2	5,14	17,35	19,35	3500	3950

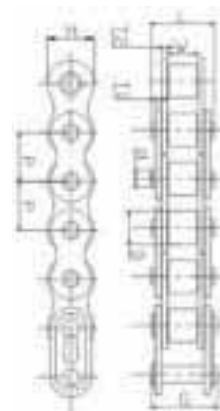

CATENE TRASMISSIONE SIGILLATE CON O-RING - O-RING SEALED DRIVE CHAINS



CATENA TRASMISSIONE SIGILLATA CON O-RING

Il disegno specifico delle catene sigillate KMC rende costante la lubrificazione prolungando la vita della catena stessa. La lega d'acciaio di qualità superiore e i trattamenti termici garantiscono una maggiore resistenza alle sollecitazioni. Inoltre, lo speciale grasso contenuto dagli anelli di tenuta, mantiene costante la lubrificazione ed elimina l'attrito durante il funzionamento, garantendo un'usura minore ed una vita della catena prolungata nel tempo.

O-RING SEALED DRIVE CHAIN

Specific design of sealed-in lubrication allows KMC sealed chain to have a longer and optimum life. Superior alloy steel and heat-treatment provides better performance in strength. In addition, special formulated grease retained by sealants ring, keeps a constant lubrication eliminating friction and prolonging chain life.

16 371 0220

MODELLO - MODEL	MAGLIE - LINKS
428UO	140

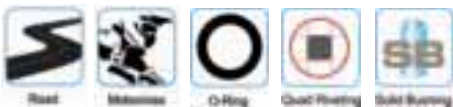

16 371 9170

GIUNTO CATENA - CONNECTING LINK
Con molletta - With clip



16 371 0030

MODELLO - MODEL	MAGLIE - LINKS
520UO	120



16 371 9080

GIUNTO CATENA - CONNECTING LINK
Con molletta - With clip



16 371 0180

MODELLO - MODEL	MAGLIE - LINKS
525SUO	120



16 371 9090

GIUNTO CATENA - CONNECTING LINK
Con molletta - With clip



16 371 0070

MODELLO - MODEL	MAGLIE - LINKS
530SUO	120

16 371 9100

GIUNTO CATENA - CONNECTING LINK
A Ribadire - Riveted



16 371 0290

MODELLO - MODEL	MAGLIE - LINKS
525SUO	130L



CODICE RMS RMS CODE	CODICE KMC KMC CODE	P PASSO PITCH	W LARGHEZZA INTERNA ROLLER LINK WIDTH	D DIAM. RULLO ROLLER DIAMETER	T SPESORE PIASTRINA EST. PIN LINK PLATE THICKNESS	T2 SPESORE PIASTRINA INT. ROLLER LINK PLATE THICKNESS	d DIAM. PERNO PIN DIAMETER	L LUNGHEZZA PERNO OVER-ALL WIDTH, RIV.	G LUNGHEZZA PERNO GIUNTO OVER-ALL WIDTH, CON.	- CARICO ROTTURA MINIMO MINIMUM TENSILE STRENGTH
UNITÀ DI MISURA UNIT OF MEASURE		mm.	mm.	mm.	mm.	mm.	mm.	mm.	mm.	KGF
16 371 0220	428UO	12,7	7,85	8,51	1,8	1,8	4,51	20,1	21,8	2100
16 371 0030	520UO	15,875	6,25	10,16	2,2	2,2	5,24	20,55	21,85	3300
16 371 0180	525SUO	15,875	7,85	10,16	2,2	2,2	5,24	22,35	22,65	3900
16 371 0070	530SUO	15,875	9,4	10,16	2,4	2,4	5,35	24,70	25	4300
16 371 0290	525SUO	15,875	7,85	10,16	2,2	2,2	5,24	22,35	22,65	3900

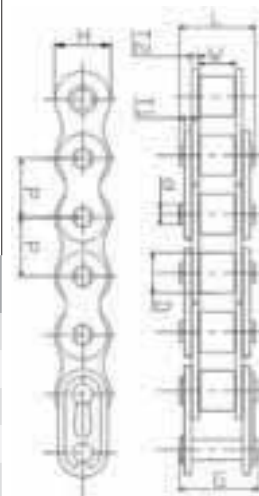

GIUNTI CATENE - CONNECTING LINKS

16 371 9070

GIUNTO CATENA - CONNECTING LINK
Con molletta - With clip

Giunto per catena 530 OR
Connecting link for 530 OR chain



16 371 9110

GIUNTO CATENA - CONNECTING LINK
A Ribadire - Riveted



CATENE TRASMISSIONE SIGILLATE CON CROSS-RING
CROSS-RING SEALED DRIVE CHAINS



CATENA TRASMISSIONE SIGILLATA CON CROSS-RING

Il disegno specifico delle catene sigillate **KMC** rende costante la lubrificazione prolungando la vita della catena stessa. La lega d'acciaio di qualità superiore e i trattamenti termici garantiscono una maggiore resistenza alle sollecitazioni. Il grasso contenuto dagli anelli di tenuta, mantiene costante la lubrificazione ed elimina l'attrito durante il funzionamento, garantendo un'usura minore ed una vita della catena prolungata nel tempo. Inoltre lo speciale profilo degli elementi sigillanti garantisce una maggiore tenuta del lubrificante, prestazioni superiori, maggior resistenza, riducendo notevolmente gli attriti.

CROSS-RING SEALED DRIVE CHAIN

Specific design of sealed-in lubrication allows **KMC** sealed chain to have a longer and optimum life. Superior alloy steel and heat-treatment provides better performance in strength. Grease retrained by sealant ring, keeps a constant lubrication eliminating friction and prolonging chain life. In addition, special shaped sealant cross ring gives to chain best performances, more resistance and tensile strength, friction reduction.

16 371 0190



MODELLO - MODEL

MAGLIE - LINKS

525EX

120



16 371 9140



GIUNTO CATENA - CONNECTING LINK

A Ribadire - Riveted



16 371 0200



MODELLO - MODEL

MAGLIE - LINKS

530EX

120



16 371 9150



GIUNTO CATENA - CONNECTING LINK

A Ribadire - Riveted



CODICE RMS RMS CODE	CODICE KMC KMC CODE	P	W	D	T	T2	d	L	G	-
		PASSO PITCH	LARGHEZZA INTERNA ROLLER LINK WIDTH	DIAM. RULLO ROLLER DIAMETER	SPESSORE PIASTRINA EST. PIN LINK PLATE THICKNESS	SPESSORE PIASTRINA INT. ROLLER LINK PLATE THICKNESS	DIAM. PERNO PIN DIAMETER	LUNGHEZZA PERNO OVER-ALL WIDTH. RIV.	LUNGHEZZA PERNO GIUNTO OVER-ALL WIDTH. CON.	CARICO ROTTURA MINIMO MINIMUM TENSILE STRENGTH
UNITÀ DI MISURA UNIT OF MEASURE		mm.	mm.	mm.	mm.	mm.	mm.	mm.	mm.	KGF
16 371 0080	520EX	15,875	6,25	10,16	2,2	2,2	5,24	20,65	20,65	3600
16 371 0190	525EX	15,875	7,85	10,16	2,2	2,2	5,24	22,35	22,35	3900
16 371 0200	530EX	15,875	9,4	10,16	2,4	2,4	6,25	24,70	24,70	4500

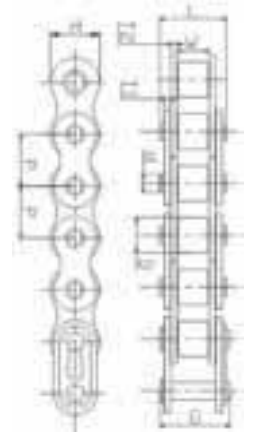

CATENE MINIMOTO - *MINIMOTO CHAINS*



16 371 0010 



MODELLO - MODEL	MAGLIE - LINKS
25HD	158

CODICE RMS RMS CODE	CODICE KMC KMC CODE	P	W	D	T	T2	d	L	-
		PASSO PITCH	LARGHEZZA INTERNA ROLLER LINK WIDTH	DIAM. RULLO ROLLER DIAMETER	SPESSORE PIASTRINA EST. PIN LINK PLATE THICKNESS	SPESSORE PIASTRINA INT. ROLLER LINK PLATE THICKNESS	DIAM. PERNO PIN DIAMETER	LUNGHEZZA PERNO OVER-ALL WIDTH. RIV.	CARICO ROTTURA MINIMO MINIMUM TENSILE STRENGTH
UNITÀ DI MISURA UNIT OF MEASURE		mm.	mm.	mm.	mm.	mm.	mm.	mm.	KGF
16 371 0010	25HD	6,35	3,18	3,3	1	1	2,31	8,9	550

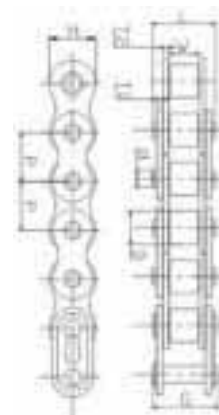



AM CHAIN è il brand più prestigioso del gruppo industriale **AMC CHAIN INDUSTRIAL CO LTD** introdotto nel mercato delle catene di trasmissione nel 2013.

Nelle catene **AM CHAIN** si è voluto confluire tutte le più avanzate tecnologie per quanto riguarda la conoscenza dei materiali, i loro trattamenti termici /galvanici e le tecnologie costruttive.

Nelle catene **AM CHAIN** troviamo trattamenti antifrizione ed antiusura, una speciale cura costruttiva di perni, rullini e maglie per garantire elevatissime caratteristiche meccaniche oltre all'utilizzo di cross ring a ridotto coefficiente d'attrito ed alta tenuta per mantenere costante la lubrificazione anche nell'uso più esasperato.

AM CHAIN is the most prestigious brand that AMC CHAIN INDUSTRIAL CO LTD introduced in the drive chain market during 2013.

AM CHAIN wants to merge all the most advanced technology and knowledge of materials, their heat treatment / plating and construction technologies.

With AM CHAIN you can find all the latest technologie concerning anti-friction and anti-wear treatments, a special design features of pins, rollers and links to ensure high mechanical characteristics as well as the use of cross ring with a low coefficient of friction and high resistance to maintain constant lubrication even in the most exasperated use.

16 371 0230

MODELLO - MODEL **MAGLIE - LINKS**

520EX-GO

120

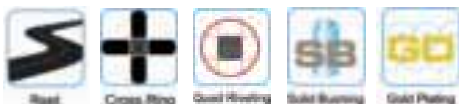

16 371 9220

GIUNTO CATENA - CONNECTING LINK

A Ribadire - Riveted



16 371 0260

MODELLO - MODEL **MAGLIE - LINKS**

520EX

120



16 371 9250

GIUNTO CATENA - CONNECTING LINK

A Ribadire - Riveted



16 371 0240 	
MODELLO - MODEL	MAGLIE - LINKS
525EX-GO	120



16 371 9230 	
Giunto Catena • Connecting Link	
A Ribadire • Riveted	



16 371 0270 	
MODELLO - MODEL	MAGLIE - LINKS
525EX	120



16 371 9260 	
GIUNTO CATENA - CONNECTING LINK	
A Ribadire - Riveted	



16 371 0250 	
MODELLO - MODEL	MAGLIE - LINKS
530EX-GO	120



16 371 9240 	
GIUNTO CATENA - CONNECTING LINK	
A Ribadire - Riveted	



16 371 0280 	
MODELLO - MODEL	MAGLIE - LINKS
530EX	120

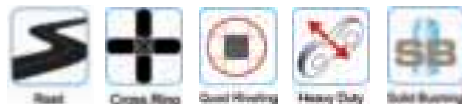

16 371 9270 	
GIUNTO CATENA - CONNECTING LINK	
A Ribadire - Riveted	



CODICE RMS RMS CODE	CODICE KMC KMC CODE	P	W	D	T	T2	d	L	G	-	-
		PASSO PITCH	LARGHEZZA INTERNA ROLLER LINK WIDTH	DIAM. RULLO ROLLER DIAMETER	SPESORE PIASTRINA EST. PIN LINK PLATE THICKNESS	SPESORE PIASTRINA INT. ROLLER LINK PLATE THICKNESS	DIAM. PERNO PIN DIAMETER	LUNGHEZZA PERNO OVER-ALL WIDTH. RIV.	LUNGHEZZA PERNO GIUNTO OVER-ALL WIDTH. CON.	CARICO ROTTURA MINIMO MINIMUM TENSILE STRENGTH	CARICO ROTTURA MEDIO AVERAGE TENSILE STRENGTH
UNITÀ DI MISURA UNIT OF MEASURE		mm.	mm.	mm.	mm.	mm.	mm.	mm.	mm.	KGf	KGf
16 371 0230	520EX-GO	15,875	6,25	10,16	2,2	2,2	5,24	20,65	20,65	3600	3800
16 371 0240	525EX-GO	15,875	7,85	10,16	2,2	2,2	5,24	22,35	22,35	3900	4200
16 371 0250	530EX-GO	15,875	9,4	10,16	2,4	2,4	6,25	24,70	24,70	4500	4700
16 371 0260	520EX	15,875	6,25	10,16	2,2	2,2	5,24	20,65	20,65	3600	3800
16 371 0270	525EX	15,875	7,85	10,16	2,2	2,2	5,24	22,35	22,35	3900	4200
16 371 0280	530EX	15,875	9,4	10,16	2,4	2,4	6,25	24,70	24,70	4500	4700



RMS

YOUR BEST PARTNER

▶ LEVE
LEVERS

▶ COMANDI GAS
PORTALEVA
GAS CONTROL

▶ RMS
YOUR BEST PARTNER

▶ COMPAGNIE MOTO
domino



**LEVE
LEVERS**

APRILIA

18 410 0010



(SX) 50: Amico 92



18 410 0021



(SX) 50: Amico 94 • Amico 96-98 • Amico GL GLE 93-95 • Amico Lx SportCat 92-93 • Gulliver S 95 • Rally 94-95 • Rally 01-03 • Sr 93-95 • Sr H2O Ditech e Carburatore - *Carburetor* 00-03 • Sr Liquid Cooled 94-95
(SX) 125: Sr 00
(R.O. AP8218153)



18 410 0031



(DX-SX) 50: Rally Lc 96-99
(R.O. AP8213279)



18 410 0041



(SX) 50: Scarabeo Tamb+Tamb • (*Disc Drum*) 93-97 • Scarabeo Disc+Tamb • (*Disc Drum*) 93-96
(R.O. AP8218176)



18 410 0051



(SX) 50: Scarabeo Disc+Tamb • (*Disc Drum*) 97 • Scarabeo Disc+Tamb • (*Disc Drum*) 99-05
(SX) 100: Scarabeo Motori Minarelli 00
(R.O. AP8218329)



18 410 0061



(SX) 50: Amico 96-98 • Gulliver – T/V/W 96-98 • Gulliver Lc 96-98 • Mojito Retro – Habana 99-03 • Rally 96-98 • Sonic 98-07 • Sonic Gp 98-08 • Sr 96 • Sr Liquid Cooled 96 • Sr Stealth, Racing 97-99 • Sr Www 97-99
(SX) 125: Mojito Retrò 99-07 • Sr 99
(R.O. AP8218274)



18 410 0071



(SX) 50: Scarabeo Disc+Disc 98-05 • Scarabeo Ditech 01-04
(SX) 125: Leonardo 96-98
(R.O. AP8118461)



18 410 0571



Impianto Heng Tong - *Heng Tong System*
(DX-SX) 50: Sr R Factory ie e Carburatore - *Carburetor* 10-14 • Sr R Factory Mot Aprilia 05 • Sr R R Factory 04-09 **(DX-SX) 125:** Sport City Eu3 06-08 • Sport City 04-06 • Sport City Street 12
(DX-SX) 200: Sport City 04-06
(DX-SX) 300: Sport City Street 12
(R.O. AP8213602)



18 410 0581



Impianto Grimeca - *Grimeca System*
(DX-SX) 50: Sr R Factory ie e Carburatore - *Carburetor* 10-11 • Sr R Factory Mot Aprilia 05 • Sr R R Factory 04-09
(DX-SX) 125: Sport City Eu3 06-08 • Sport City 04-06
(R.O. AP8590035)



18 410 0771



Impianto Heng Tong - *Heng Tong System*
(DX-SX) 125: Atlantic 03-05 • Atlantic Eu3 06-12 • Scarabeo le Light 09-12 • Scarabeo Light 07-08 • Scarabeo Motore Piaggio Eu3 06 • Scarabeo 04-06 • Sport City Cube 08-10
(DX-SX) 250: Scarabeo Light 06-08 • Sport City Cube 08-10
(DX-SX) 300: Atlantic 10-11 • Scarabeo Light 09-10
(DX-SX) 400-500: Atlantic Sprint 05-08 • Scarabeo Light 06-08
(R.O. AP8133809)



18 410 0861



(SX) 50: Sr Motard 12-13 • Sport City One 2T 08-11 • Sport City One 4T 08-10
125: Sr Motard 12-13 • Sport City One 4T Eu 3 08-11
(R.O. 564681)



18 410 1001



(SX) 50: Mojito Custom 2T Mot. Piaggio 04-10 • Mojito Custom 99-03
125: Mojito Custom 99-07 • Mojito 08
(R.O. AP8218495)



● Terminale grosso - *Big end lever*
■ Colore nero - *Black*
□ Colore lucido - *Glossy*

GRI Grimeca
H.T. Heng Tong
BRE Brembo

DX Destra - *Right*
SX Sinistra - *Left*

LEVE
LEVERS



APRILIA

18 412 0010 

(DX) 50: Amico 92



18 412 0021 

Impianto Grimeca - *Grimeca System*
(DX) 50: Amico 96-98 • Amico GL GLE 93-95 • Amico Lx Sport Cat 92-93 • Rally 94-95 • Rally 01-03 • Scarabeo Disc+Tamb • (*Disc Drum*) 93-96 • Sr 93-95 • Sr Liquid Cooled 94-95
(R.O. AP8218156)



18 412 0041 

(DX) 50: Scarabeo Tamb+Tamb • (*DrumDrum*) 93-97 (R.O. AP8218172)



18 412 0051 

Impianto Grimeca - *Grimeca System*
(DX) 50: Amico 96-98 • Rally 96-98 • Scarabeo 4T 02-06 • Scarabeo 4T Rst Eu3 06-09 • Scarabeo Ditech 01-04 • Scarabeo Quattro 09 • Scarabeo Street 05-06 • Scarabeo Street 2T Rst 06-09 • Sr 96 • Sr Liquid Cooled 96
(DX) 100: Scarabeo 4T 01-04 • Scarabeo 4T Net 10 • Scarabeo 4T Rst 06-09 • Scarabeo Motore Minarelli 00
(DX) 125: Leonardo 96-98
(R.O. AP8218273)



18 412 0061 

Impianto Grimeca - *Grimeca System*
(DX) 50: Gulliver Lc 96-98 • Mojito Retro - Habana 99-03 • Sonic 98-07 • Sonic Gp 98-08 • Sr Stealth, Racing 97-99 • Sr Stealth, Racing 97 • Sr Www 97-99
(DX) 125: Mojito 03-07 • Mojito Retrò • Custom 99-01 • Sr 99
(SX) 50: Sr Stealth, Racing 97



18 412 0501 

Impianto Grimeca - *Grimeca System*
(DX-SX) 50: Sr Ditech Eu2 02-03 • Sr H2O Ditech e Carburatore - *Carburetor* 00-03 • Sr Street 03-11
(DX) 125: Sr 00
(R.O. AP8218549)



18 412 0521 

(DX-SX) 500: Atlantic 01-04 • Scarabeo 03-06
(DX-SX) 125: Scarabeo Motore Rotax 99-01
(R.O. AP8118542)



18 412 0531 

(DX-SX) 250: Leonardo 99-04
(R.O. AP8218480)



18 412 0651 

Impianto Heng Tong - *Heng Tong System*
(DX) 50: Sport City One 2T/4T 08-10
(DX) 125: Sport City One 4T Eu3 08-10
(R.O. 497041)



18 412 0661 

Impianto Heng Tong - *Heng Tong System*
(DX-SX) 50: Sr Iniezione e Carburatore 14 - *Carburetor* 14 • Sr R Factory ie e Carburatore - *Carburetor* 10-14 • Sr Street
(DX-SX) 125: Sr Max 11-14
(DX-SX) 300: Sr Max 11-14
(R.O. 600475)



18 412 0711 

Impianto Heng Tong - *Heng Tong System*
(DX) 50: Scarabeo 4T 4V Net 10 • Scarabeo 2T Net 10
(DX) 100: Scarabeo 4T 10
(R.O. 497042)



18 412 0931 

Impianto Heng Tong - *Heng Tong System*
(DX) 50: Scarabeo 2T Net 09 • Scarabeo 4T 4V Net 09 • Scarabeo 4T Restyling Eu3 06-09 • Scarabeo 4T 02-06 • Scarabeo Quattro 09 • Scarabeo Street 2T Restyling 06-09 • Scarabeo Street 05-06
(DX) 100: Scarabeo 4T Net 10 • Scarabeo 4T Restyling 06-09
(R.O. AP8218640)





LEVE
LEVERS

APRILIA

18 412 0941 

(DX) 50: Mojito Custom 99-03 • Mojito 04-08
125: Mojito Retrò Custom 99-01 • Mojito 03-08
660: Pegaso Strada (Fun) - Factory - Tr 05-09
(R.O. AP8218479)

18 412 0971 

(DX-SX) 50: Sr Street 03-12
(R.O. AP8213597)



DERBI

18 410 0571 

Impianto Heng Tong - *Heng Tong System*
(SX) 125: Rambla Eu3 – II Vers. 08-09
(SX) 300: Rambla 10-11
(R.O. AP8213601)



18 410 0581 

Impianto Grimeca - *Grimeca System*
(SX) 125: Rambla Eu3 – II Vers. 08-09
(SX) 300: Rambla 10-11
(R.O. AP8590035)



18 410 0601  ●

(SX) 50: Boulevard 2T 09-10 • Boulevard 4T 09-10 • Boulevard 2T 09-10 • Boulevard 4T 09-10 • Sonar 2T 10-11
(SX) 100: Boulevard 4T 10
(SX) 125: Sonar 4T 09
(SX) 150: Boulevard Eu3 – II Vers. 10 • Boulevard Eu3 110 • Sonar 4T 09
(R.O. 564683)



18 410 0861 

(SX) 50: Variant Sport 2T 12
125: Variant Sport 4T Eu 3 12 • Boulevard 02-07
150: Boulevard 02-07
200: Boulevard 05
(R.O. 564681)



18 412 0652 

Impianto Heng Tong - *Heng Tong System*
(DX) 50: Boulevard 2T 09-10 • Sonar 2T 10-11
(DX) 100: Boulevard 4T 10
(R.O. 646833)



18 412 0711  ●

Impianto Heng Tong - *Heng Tong System*
(DX) 50: Boulevard 4T 09-10
(DX) 125: Sonar 4T 09
(DX) 150: Boulevard Eu3 110 • Sonar 4T 09
(R.O. 497042)



GILERA

18 412 0731  ●

Impianto Grimeca - *Grimeca System*
(DX) 50: Boulevard 2T 09-10 • Boulevard 4T 09-10
(DX) 100: Boulevard 4T 10
(DX) 150: Boulevard Eu3 – II Vers. 10
(R.O. 646803)



18 410 0111 

(SX) 50: Easy Moving 95-96 • Storm 94-95 • Typhoon 94-97 • Typhoon X 98-99 • Typhoon Xr 00
(R.O. 564689)



18 410 0181 

(SX) 50: Storm Eu2 07
(SX) 125: Runner FxFxr 97-02
(R.O. 561131)



● Terminale grosso - *Big end lever*
■ Colore nero - *Black*
□ Colore lucido - *Glossy*

GRI Grimeca
H.T. Heng Tong
BRE Brembo

DX Destra - *Right*
SX Sinistra - *Left*

LEVE
LEVERS



GILERA

18 410 0531 

(SX) 50: Stalker 97-06 • Stalker 07-09 • Stalker Spec Edit 07-08
(R.O. 562450)



18 410 0591 

(SX) 50: Stalker 97-06 • Stalker 07-09 • Stalker Spec Edit 07-08
(R.O. 564682)



18 410 0601 

(SX) 125: Runner Fx Fxr 97-02
(R.O. 564683)



18 410 0851 

(SX) 50: Ice 01-05 • Stalker Naked 08
(R.O. 647552)



18 412 0091 

(DX) 50: Storm 94-95 • Typhoon 94-97 • Typhoon X 98-99 • Typhoon Xr 00
(R.O. 564690)



18 412 0101 

(DX) 125: Typhoon 95-98 • Typhoon XXr 99-00
(R.O. 271449)



18 412 0111 

Impianto Grimeca - *Grimeca System*
(DX-SX) 50: Runner 97-00 • Runner Poggiali 02 • Runner Purejet 02-04 • Runner Sp 02-04 • Stalker 97-00
(DX-SX) 180: Runner VxVxr 00-04
(DX) 180: Runner FxFxr 97-02
(SX) 125: Runner FxFxr 97-02
(R.O. 494952)



18 412 0231 

(DX) 50: Easy Moving 95-96
(R.O. 494951)



18 412 0601 

Impianto Brembo - *Brembo System*
(DX-SX) 50: Dna 00-07 • Dna Gp Experience 03-04
(DX-SX) 500: Fuoco Eu3 07-11 • Nexus 03-05 • Nexus Eu3 06-11 • Nexus Sp Eu3 06-07
(SX) 125: Dna 01
(R.O. 646829-497031)



18 412 0651 

Impianto Heng Tong - *Heng Tong System*
(DX-SX) 50: Runner Poggiali 02 • Runner Purejet 02-04
(DX-SX) 125: Runner FxFxr 97-02 • Runner VxVxr 00-01
(DX) 50: Stalker 07-09 • Stalker Spec Edit 07-08
(SX) 180: Runner FxFxr 97-02
(R.O. 497041)



18 412 0652 

Impianto Heng Tong - *Heng Tong System*
(DX-SX) 50: Runner Purejet 05-10 • Runner Purejet St 08 • Runner Sp 05-07 • Runner Sp 10 • Runner Sp Spec Edit 07 • Storm Eu2 07
(DX-SX) 125: Runner Vx 05-06 • Runner Vx 4T Eu3 07 • Runner Vx 4T St Eu3 08-09 • Runner Vx Race 06 • Runner VxVxr 00-01
(DX-SX) 200: Runner Vxr 05-06 • Runner Vxr 4T St Eu3 08 • Runner Vxr Eu3 07
(DX-SX) 180: Runner VxVxr 00-04
(R.O. 646833)



18 412 0661 

Impianto Heng Tong - *Heng Tong System*
(DX-SX) 50: Dna 00-07 • Dna Gp Experience 03-04
(DX-SX) 125: Nexus Eu3 07-08 • Nexus Eu3 le 08-10
(DX-SX) 250: Nexus Eu3 06-07 • Nexus Sp Eu3 06-07
(DX) 50: Stalker Naked 08 - **(SX) 300:** Nexus Eu3 08-09 - **(SX) 500:** Fuoco Eu3 07-11
(R.O. 600475)





LEVE
LEVERS

GILERA

18 412 0711



Impianto Heng Tong - *Heng Tong System*
(DX-SX) 50: Runner Purejet 05-10 • Runner Purejet St 08 • Runner Sp 05-07 • Runner Sp 10 • Runner Sp Spec Edit 07
(DX-SX) 125: Runner FxFxr 97-02 • Runner Vx 05-06 • Runner Vx 4T Eu3 07 • Runner Vx 4T St Eu3 08-09
(DX-SX) 180: Runner FxFxr 97-02 • Runner VxVxr 00-04
(DX-SX) 200: Runner Vxr 05-06 • Runner Vxr 4T St Eu3 08 • Runner Vxr Eu3 07 • Runner Vxr Race 06
(R.O. 497042)

18 412 0721



Impianto Brembo - *Brembo System*
(DX-SX) 50: Dna 00-07 • Dna Gp Experience 03-04
(DX) 50: Ice 01-05
(SX) 125: Dna 01
(DX) 500: Fuoco Eu3 07-11
(DX-SX) 500: Nexus 03-05 • Nexus Eu3 06-11 • Nexus Sp Eu3 06-07
(R.O. 497031)

18 412 0731



Impianto Grimeca - *Grimeca System*
(DX) 50: Runner Sp Spec Edit 07
(DX-SX) 125: Runner Vx 05-06 • Runner Vx Race 06
(DX-SX) 200: Runner Vxr 05-06 • Runner Vxr Eu3 07 • Runner Vxr Race 06
(SX) 125: Runner Vx Sc 06-07
(R.O. 646803)



HONDA

18 410 0341



(SX) 50: Sh 19-95> • FiftyBalj
• Sh Freno Disco - *Brake Disc*
100: Bali

18 410 0371



(SX) 50: Sky Freno Disco - *Brake Disc*

18 410 0381



(SX) 50: Sky 96>
• Sh Freno Disco - *Brake Disc 96>*



18 410 0391



(SX) 50: Sfx Vision • Pk Wallaro

18 410 0441



(SX) 125-150: @ • Sh • Dylan

18 410 0451



(SX) 125-150-250: Pantheon • Foresight



18 410 0611



(SX) 125: Sh L 09-10
(SX) 150: Sh L 09-10
(SX) 300: Sh 07-08 • Sh L 07-08

18 412 0421



(DX) 50: Sky F.D. <96

18 412 0431



(DX) 50: Sfx • Sh Freno Disco - *Brake Disc 96>*



● Terminale grosso - *Big end lever*
■ Colore nero - *Black*
□ Colore lucido - *Glossy*

GRI Grimeca
H.T. Heng Tong
BRE Brembo

DX Destra - *Right*
SX Sinistra - *Left*

LEVE
LEVERS



HONDA

18 412 0441 

(DX) 50-100: Balj



18 412 0541 

(DX) 125-150: @ • Sh • Dylan



18 412 0551 

(DX) 125-150-250: Pantheon • Foresight



ITALJET

18 412 0741 

(DX) 125: Sh L 09-10

(DX) 150: Sh L 09-10

(DX) 300: Sh 07-08 • Sh I 07-08



18 410 0131 

(SX) 50: Pista • Bazoka • Scoop • Dj W 94-00

• Dj X 91-92 • Djy 93



KYMCO

18 410 0461 

(SX) 50: Mixer 02-03 • Mixer Eu2 04 • Mxu 06-07 • Mxu Sr 06

(SX) 125: Dink Eu3 06-07 • Dink 97-98

(SX) 200: Dink Eu3 L 06-07

(R.O. 00153984)



18 410 0471 

(SX) 125: B&w 00 • B&w Eu2 03-04 • Dink Classic 02 • Dink Lx 98-00 • Grand Dink 01-02 • People Gti 10

(SX) 150: B&w 00 • B&w Eu2 03-04 • Dink Classic Eu2 02-03 • Dink Lx 98-00 • Grand Dink 01-02 • Grand Dink Eu2 03-04

(SX) 200: Dink Classic 04 • People Gti 10

(SX) 250: B&w 00 • B&w Eu2 03 • Grand Dink Eu2 03-04 • People Lc 03-04 • People S 06 • People S 250L 07 • Yup 03

(SX) 300: People Gti 10 • People S 300 L 08

(R.O. 00153977)



18 410 0481 

(SX) 50: Agility 4T R12 07-08 • Agility R12 05 • Fever Zx Eu2 03-04 • People 99-00 • People Eu2 08-11 • Sento 08 • Vitality 2T 04 • Vitality 4T 04 • Yup Eu2 03

(SX) 125: Agility 4T 06 • Agility 4T Eu3 06-08 • Movie 99-00 • Movie Eu3 06-07 • Movie XL Eu2 03-04 • People 99-00 • People Eu3 07-11 • People S 05 • Vivio 00

(SX) 150: Movie Eu3 06-07 • People 99-00 • People Eu2 03

(SX) 200: People S 05

(R.O. 0015216100152050)



18 410 0541 

(SX) 50: Super 9 00 • Super 9 Sport Eu2 03-04

(SX) 125: Like 09 • People S Dd Eu3 07-08

(SX) 200: Like 200L 09 • People S 20-01 07

(R.O. 00153782)



18 410 0711 

(SX) 50: Agility 4T R10 06-08 • Top Boy 97-00

(R.O. 00152580)



18 410 0721 

(SX) 50: Agility 4T R16 08 • Agility 4T R16 09

(R.O. 00153308)





**LEVE
LEVERS**

KYMCO

18 410 0741



(SX) 50: People S 05-08 • People S 4T 06-08
• Super 8 07 • Super 8 2T 09 • Super 8 4T 09
(SX) 125: Super 8 08-09
(R.O. 00153759)



18 410 0751



(SX) 125: Agility R16 08-09
(SX) 150: Agility R16 08 • Agility R16 09
(SX) 200: Agility L R16 10
(R.O. 00153414)



18 410 0761



(SX) 125: Downtown I 09 • **200:** Downtown I
10 • **300:** Downtown I 09 • Downtown Abs I 11
• Downtown Abs 10 • Downtown I11 • X Citing
I R 08-09 • X Citing I 08 • **700:** Myroad I 11
(R.O. 00153298)



18 412 0461



(DX) 50: Dink 50 4T 07
(DX) 125: Dink Eu3 06-07 • Dink 97-98
(DX) 200: Dink Eu3L 06-07
(R.O. 00156915)



18 412 0571



(DX) 50: B&w 02 • B&w Eu2 03 • Dink Classic
Eu2 03 • Dink Lc 99-02
(DX) 125: B&w 00 • B&w Eu2 03-04 • Dink
Classic 02 • Dink Classic Eu2 03 • Dink Lx 98-00
• People Gti 10
(DX) 150: B&w 00 • B&w Eu2 03-04 • Grand
Dink 01-02 • Grand Dink Eu2 03-04
(DX) 200: Dink Classic 04 • People Gti 10
(DX) 250: B&w 00 • B&w Eu2 03 • Grand Dink
01-02 • People Lc 03-04 • People S 06 • People
S 250L 07 • Yup 03
(DX) 300: People Gti 10 • People S 300L 08
(R.O. 00153960)



18 412 0581



(DX) 50: Agility 4T R12 07-08 • Agility R12 05
• Agility Rs 09 • Agility Rs Naked 2T 10 • People
99-00 • People 04 • Sento 08 • Super 8 07 •
Super 8 2T 09 • Super 8 4T 09 • Vitality 2T 04 •
Vitality 4T 04 • Yup Eu2 03
(DX) 125: Agility 4T 06 • Agility 4T Eu3 06-08
• Agility Rs 09 • People 99-00 • People Eu2 03 •
People Eu3 07-11 • Super 8 08-09
(DX) 150: People 99-00 • People Eu2 03
(R.O. 00153159)



18 412 0681



(DX) 50: Fever Zx 99-00 • Fever Zx Eu2 03-04 •
Like 2T 09 • People S 05-08 • People S 4T 06-08
• Super 9 00 • Super 9 Sport Eu2 03-04
(DX) 125: Like 09 • Movie 99-00 • Movie 125
Eu3 06-07 • Movie XL 01 • Movie XL Eu2 03-04
• People S 05 • People S Dd Eu3 07-08 • Vivio 00
(DX) 150: Movie Eu3 06-07
(DX) 200: Like 200L 09 • People S 05 • People
S 200L 07
(R.O. 00153760)



18 412 0761



(DX) 50: Agility 4T R10 06-08 • Agility 4T R16
08 • Agility 4T R16 09 • Top Boy 97-00
(DX) 125: Agility R16 08-09
(DX) 150: Agility R16 08 • Agility R16 09
(DX) 200: Agility I R16 10
(R.O. 00153413)



18 412 0801



(DX) 125: Downtown I 09 • **200:** Downtown I
10 • **300:** Downtown I 09 • Downtown Abs I 11
• Downtown Abs 10 • Downtown I11 • X Citing
I R 08-09 • X Citing I 08 • **700:** Myroad I 11
(R.O. 00153297)



LEM

18 410 0131



(SX) 50: Flash • Tornado – Centro Base 93-94 •
Centro SL 94-95 • F10 Jet Line 92-93



- Terminale grosso - *Big end lever*
- Colore nero - *Black*
- Colore lucido - *Glossy*

GRI Grimeca
H.T. Heng Tong
BRE Brembo

DX Destra - *Right*
SX Sinistra - *Left*

LEVE
LEVERS



LML

18 410 0251 

(DX-SX) 125-150: LML Freno Tamburo
Brake Shoes
(R.O. 138836)



18 410 0911 

(SX) 125-150: LML Freno Disco - *Brake Disc*
(R.O. 225340)



18 412 0791 

(DX) 125-150: LML Freno Disco - *Brake Disc*
(R.O. 494804)



MALAGUTI

18 410 0361 

(SX) 50: Centro SL 96-98 • Centro SL Kat 99-00 • Ciak 99-00 • Ciak Master 04 • Ciak Mono Eu2 2.3 03 • Crosser Cr1 95-98 • F10 Ac 08 • F10 Rst Eu1 01-02 • F10 Rst Eu2 06 • F12 Aria Rst Eu2 06 • F12 Phantom 94-98 • F12 Phantom Lc 94-98 • F12 Phantom Rst Eu2 02 • F15 Fire Fox Ac 05-06 • Yesterday Euro 97-00
(SX) 125: Ciak 00-01 • Ciak Master 04 • Ciak Master Eu3 06
(SX) 150: Ciak 00-02 • Ciak Master 04 • Ciak Rst Eu2 03
(SX) 200: Ciak Master Eu2 06
(R.O. 12113303)



18 410 0631 

(SX) 50: Ciak Td 00-01 • F12 Lc Rst Eu2 06 • F12 Phantom Lc Eu1 99-00 • F12 Phantom Lc Rst Eu2 02 • F12 Phantom Lc Twin Disks 98 • F12R Phantom Lc 07-10 • F15 Fire Fox 96-98 • F15 Fire Fox eu2 02-03 • F15 Fire Fox Rst Eu2 2.3 03-04 • F15 Fire Fox Twin Disks 98-99 • F15 Lc Rst Eu2 04-05
(SX) 100: Ciak 99-00 • F12 Phantom 99-00
(SX) 125: F18 Warrior 00-02
(R.O. 12114203)



18 410 0641 

(SX) 50: F12R Phantom Lc (Da Manubrio ZJM5883) 0710
(SX) 125: Blog 11 • Centro SI 11
(SX) 160: Blog le 11 • Centro SI 11
(R.O. 12121103)



18 410 0651 

(SX) 50: Centro 4T 08 • Centro SI 4T 10 • F12R Phantom Ac 09-10
(R.O. 12120903)



18 410 0661 

(SX) 125: Blog 09-10 • Centro le 08-09 • Centro SI 09-10
(SX) 160: Blog 09-10 • Centro le 08-09
(R.O. 12119803)



18 410 0671 

SX 50: F12R Phantom Ac 07-08
(R.O. 12120703)



18 412 0411 

DX 50: Centro SL 94-98 • Centro SL Kat 99-00 • Ciak 99-00 • Ciak Master 4T 05-06 • Ciak Master Eu2 06 • Ciak Mono Eu2 03 • Ciak Td 00-01 • Crosser Cr1 95-98 • F10 Ac 08 • F10 Jet Line 92-98 • F10 Kat 99-00 • F10 Rst Eu1 01-02 • F10 Rst Eu 22.3 03-04 • F10 Rst Eu2 02-03 • F10 Rst Eu2 06 • F12 AC/Lc Rst Eu2 06 • F12 Phantom 94-98 • F12 Phantom Lc 94-98 • F12 Phantom Lc Eu1 99-00 • F12 Phantom Lc Rst Eu1/Eu2 01-02 • F12 Phantom Lc Twin Disks 98 • F12 Phantom Rst Eu1/Eu2 01-02 • F12R Phantom Ac 07-08 • F12R Phantom Lc 07-10 • F15 Fire Fox 96-98 • F15 Fire Fox Ac 05-06 • F15 Fire Fox eu2 02-03 • F15 Fire Fox Twin Disks Kat 98-00 • F15 Lc Rst Eu2 04-05 • Yesterday Eu 97-00
(DX) 100: Ciak 99-00 • F12 Phantom 99-00
(DX) 125: Ciak 00-01 • Ciak Master 04 • Ciak Master Eu3 06 • Ciak Rst Eu2 03 • F18 Warrior 00-02
(DX) 150: Ciak 00-02 • Ciak Master 04 • Ciak Rst Eu2 03 • F18
(DX) 200: Ciak Master Eu2 06 Warrior 00-02
(R.O. 12113203)





LEVE
LEVERS

MALAGUTI

18 412 0591 

(DX-SX) 125: Madison 99-01 • Madison 3 06-09 • Madison R Rst 02 • Phantom Max 03
(DX-SX) 200: Madison S Rst 02 • Madison S Rst Eu2 03 • Phantom Max 03
(DX-SX) 250: Madison 3 06-09 • Madison S 99-01 • Password 05-06 • Password Eu3 07-08
(DX-SX) 400: Madison K 02 • Madison KRst 02-04
(DX-SX) 500: Spidermax Gt 04-05 • Spidermax Gt eu3 06
(SX) 150: Madison T 99-01
(SX) 160: Centro SI 09-10
(SX) 180: Madison R 01-02
(R.O. 12114303)



18 412 0771 

(DX) 50: Centro 4T 08 • Centro SI 4T 10 • F10 Ac Eco 09-10 • F12R Phantom Ac 09-10 • F12R Phantom Lc (Da Manubrio ZJM5883) 07-10
(DX) 125: Blog 11 • Centro SI 11
(DX) 160: Blog le 11 • Centro SI 11
(R.O. 12121003)



18 412 0781 

(DX) 125: Blog 09-10 • Centro le 08-09 Centro SL 09-10
(DX) 160: Blog 09-10 • Centro le 08-09 Centro SL 09-10
(R.O. 12119703)



MBK

18 410 0010 

(SX) 50: Booster 90-94 • Evolis 92-96
(R.O. 3VLH39120100)



18 410 0021 

(SX) 50: Looxor 01-03 • Looxor TsdI 02 • Ludix 10 Trend • Snake 04 • Ludix 14 Elegant 04 • Speedake 95-97 • Speedfight 2 Ac 05-06 • Speedfight Lc 97-98 • Speedfight Ac 97-98 • Speedfight Ac Cat 99 • Squab 95-97 • Trekker 98-00 • Vivacity 99 • Vivacity Cat 99-02 • XFight Ac 00 • Zenith L 94-96 • Zenith LnLs 97-98
(SX) 100: Elyseo 99-01 • Trekker 98 • Vivacity 99-01
(SX) 125: Sv Tamburo/Drum 91-95 • Elyseo 99-00 • Elyseo 01
(SX) 150: Elyseo 99-00
(R.O. 754174)



18 410 0131 

(SX) 50: Ct S/Ss Sorriso 91-95 • Ct Ss New Sorriso 95-96 • Target 91-95
(R.O. 1NTH391200)



18 410 0141 

(SX) 100: Ovetto 00-02
(R.O. 5ADH391202)



18 410 0151 

(SX) 50: Booster R Road 94-95 • Booster Spirit 96-98 • Evolis 95 • Fizz 94-95 • Forte 94-95
(R.O. 4KHH391200)



18 410 0161 

(SX) 50: Booster Ng 95-98 • Booster Rocket 97-98 • Booster Spirit Special 00 • Booster Track 96-98
(R.O. 4SBH391200)



18 410 0401 

(SX) 50: Booster 01-03 • Booster L 01-03 • Booster Naked 03 • Booster Ng 01-03 • Booster Ng Eu2 01-06 • Booster Spirit Eu2 Sp 02-03 • Booster Spirit L 03 • Mach G Eu1Eu2 02-04 • Stunt 00-02
(R.O. 5JHH391200)



18 410 0411 

(SX) 50: Flipper Cat 6900 • Flipper 98-02 • Flipper Eu2 01-04
(R.O. 5EUH391200)



18 410 0421 

(SX) 50: Booster Ng 99 • Booster Spirit 99-00
(R.O. 4SBH391210)



● Terminale grosso - Big end lever
 ■ Colore nero - Black
 □ Colore lucido - Glossy

GRI Grimeca
H.T. Heng Tong
BRE Brembo

DX Destra - Right
SX Sinistra - Left

LEVE
LEVERS



MBK

18 410 0491 

(SX) 125: Doodo 00-02 • Skyliner 98-02
(SX) 150: Doodo 01-02 • Skyliner 00
 (R.O. 5DSH391201)



18 410 0501 

(SX) 250: Skyliner Abs 00-03
 (R.O. 5CG839121100)



18 410 0801 

(SX) 100: Yw Booster 99-01
 (R.O. 4VPH39121000)



18 412 0010 

(DX) 50: Booster 90-94
 (R.O. 3VLH39221000)



18 412 0151 

(DX) 50: Booster R Road 94-95 • Booster Spirit Special 0 • Evolis 92-96 • Evolis 95 • Fizz 94-95 • Forte 94-95 • Target 91-95
(DX) 125: Xc K Flame R 97-98
(DX) 150: Vertex 97
 (R.O. 2NA8392201)



18 412 0161 

(DX) 50: Booster Spirit 96-98
 (R.O. 4VVH392200)



18 412 0171 

(DX) 50: Booster Ng 95-98 • Booster Track 96-98
 (R.O. 4SBH392200)



18 412 0181 

(DX) 50: Booster Rocket 97-98
 (R.O. 4TDH392200)



18 412 0391 

(DX-SX) 50: Nitro Tutti – Jaguar Eu2 97-04
 (R.O. 5BRH39120100)



18 412 0401 

(DX) 50: Ovetto Eu1Eu2 • Tutti 97-04
(DX) 100: Ovetto 00-02
 (R.O. 5ADH392201)



18 412 0471 

(DX) 50: Booster Spirit 99-00
 (R.O. 4VVH392210)



18 412 0481 

(DX) 50: Booster Ng 01-03 • Booster Ng Eu2 01-06 • Stunt 00-02
 (R.O. 5JHH392200)



18 412 0491 

(DX) 50: Flipper Cat 69-00 • Flipper 98-02 • Flipper Eu2 01-04
 (R.O. 5EUH392200)



18 412 0511 

(DX) 50: Booster Ng 99
 (R.O. 4SBH392210)



18 412 0601 

(DX) 125: Doodo 00-02 • Skyliner 98-02 • Skyline E 01-03 • Thunder 01-02
(DX) 150: Doodo 01-02 • Skyliner 00 • Skyliner 01-02 • Thunder 01-02
(SX) 125: Skyline E 01-03 • Thunder 01-02
(SX) 150: Skyliner 01-02 • Thunder 01-02
(SX) 180: Skyliner E 03-08
(SX) 300: Kilibre 03-06
 (R.O. 5DSH392201)





**LEVE
LEVERS**

MBK

18 412 0611



(DX) 250: Skyliner Abs 00-03
(R.O. 5CG8392201)



18 412 0671



Impianto AJP - *AJP System*
(DX) 50: Elyseo 99 • Jet Force 03 • Looxor 01-03 • Ludix 10 Trend • Snake 04 • Ludix 14 Elegant 04 • Speedfight Lc 97-98 • Speedfight Ac 97-98 • Trekker 98-00 • Vivacity 99 • Vivacity Cat 99-02 • XFight LcAc 00 • Zenith L 94-96 • Zenith LnLs 97-98
(DX) 100: Elyseo 99-01 • Speedfight 97-00 • Vivacity 99-01
(DX) 125: Elyseo 99-00 • Elyseo 01
(DX) 150: Elyseo 99-00
(SX) 50: Jet Force 03 • Speedfight Lc ICDICDP 97-98 • XFight Lc 00
(SX) 100: Speedfight 97-00 • XFight 00-01
(R.O. 752868)



18 412 0691



(DX-SX) 50: Jet Force 03
(DX) 50: MetalX 02 • Trk2 Wrc 04-06
(DX-SX) 100: Looxor 01 • Speedfight 97-00 • XFight 00-01
(DX-SX) 50: Speedfight 2 LcSilversport 05-06 • Speedfight Ac 97-98 • XFight Lc 00 • Xrace 03
(R.O. 757025-754709)



18 412 0701



Impianto Heng Tong - *Heng Tong System*
(DX) 50: Elyseo 99 • Speedfight 2 Ac 05-06 • Speedfight Lc 97-98 • Speedfight Ac ICDICDP 97-98 • Speedfight Ac 97-98 • Speedfight Ac Cat 99 • Squab 95-97 • Vivacity 99 • Vivacity Cat 99-02 • XFight Ac 00 • Zenith L 94-96 • Zenith LnLs 97-98
(DX) 100: Elyseo 99-01 • Sv L 98 • Vivacity 99-01 • XFight 00-01
(DX) 125: Elyseo 99-00
(SX) 50: Speedfight Ac ICDICDP 97-98 • XFight Lc 00
(SX) 100: XFight 00-01
(R.O. 752864)



18 412 0821



(DX) 50: Cw Booster Naked 03 • Cw Booster Spirit Eu2 02-03 • Cw Booster 01-02 • Cw L Booster Spirit 03 • Cw L Booster 01-03 • Cw Sp Booster Spirit Eu2 02
(R.O. 5NTH39220000)



18 412 0891



(DX) 50: Cs Mach G Eu1 02-03 • Cs Mach G Eu2 02-04
(R.O. 5RWH392200)



PGO

18 410 0131



(SX) 50: Big Max 96



18 412 0151



(DX) 50: Big Max 96



● Terminale grosso - Big end lever
■ Colore nero - Black
□ Colore lucido - Glossy

GRI Grimeca
H.T. Heng Tong
BRE Brembo

DX Destra - Right
SX Sinistra - Left

LEVE
LEVERS



PIAGGIO

18 410 0111 

(SX) 50: Free Delivery 00-01 • Free FL 95-02 • Nrg 94-96 • Ntt 95-96 • Quartz 92-96 • Typhon 01-04 • Zip 95-96 • Zip Fast Raider 93-94 • Zip Fast Raider Rst 96-97 • Zip Rst Freno Disc/Disc 96-99 • Zip Rst Freno Tamburo/Drum 96-99 • Zip Sp 96-00
(SX) 100: Free 02-03
(SX) 125: Skipper 94-97 • Super Hexagon Gtx 12 01-02
(R.O. 564689)



18 410 0170 

(SX) 50: Free 92-94 • Zip 92-93 • Zip Bimodale 94-97
(R.O. 269070)



18 410 0181 

(SX) 50: Fly 2T 05-07 • Fly 2T 10 • Fly 4T 05-10 • Liberty 2T 06-08 • Liberty 2T Rst 04 • Liberty 4T 05-08 • Liberty 4T Rst 04 • Liberty 4T Sport 06-08 • Vespa Lx 2T 05-08 • Vespa Lx 2T Touring 10-11 • Vespa Lx 4T 05-08 • Vespa Lx 4T4V 09-10 • Vespa Lx 4T4V Touring 10-11 • Vespa S 4T4V & Coll 08-11
(SX) 100: Fly 4T 06-07
(SX) 125: Fly 05-07 • Fly Eu3 08 • Hexagon LxLxt 98-99 • Hexagon Lx4 98-99 • Liberty 4T 06-07 • Liberty 4T Eu3 07-08 • Liberty Sport 06 • Vespa Lx 05-06 • Vespa Lx 4T FI 09 • Vespa Lx Eu3 le 09-10 • Vespa Lx Touring 10-11 • Vespa S 4T Eu3 07-08 • Vespa S 4T le & Colledge 09-11
(SX) 150: Fly 05-07 • Fly Eu3 08-10 • Liberty 4T Eu3 08 • Liberty 4T Sport Eu3 08 • Liberty Moc 4T 09-10 • Vespa Lx 05-06 • Vespa Lx 4T FI 09 • Vespa Lx Eu3 06-08 • Vespa Lx Eu3 le 09-11 • Vespa Lx Touring 10-11 • Vespa S 4T 08-09 • Vespa S 4T le & Colledge 09-11
(SX) 200: Liberty 06 • Liberty 4T Eu3 07-08 • Liberty 4T Sport Eu3 06-07 • Liberty Rst 04 • Liberty Sport 06
(R.O. 561131)



18 410 0201 

(SX) 50: Liberty 97-05 • Liberty 4T 00-02 • Liberty Ptt Eu2 04-05 • Vespa Et2 97-05 • Vespa Et2 Iniezione 97-00 • Vespa Et4 00-05
(SX) 125: Liberty 98-02 • Liberty 01-02 • Vespa Et4 96-02 • Vespa Et4 99-02
(R.O. 564642)



18 410 0211 

(DX-SX) 50: Vespa elestart 70-76 • Vespa special 70-83
(DX-SX) 125: Vespa Et3 75-83 • Vespa Gtr 69-78
(R.O. 165279)



18 410 0212 

(DX-SX) 50: Vespa L 66-70 • Vespa R 70-83 • vespa S 63 • Vespa Super Sprint 66-71
(DX-SX) 90: Vespa 63 • Vespa Racer 71-73 • Vespa Super Sprint 65-71
(DX-SX) 125: Vespa 55-60 • Vespa 61-67 • Vespa Primavera 67-83 • Vespa Super 66-74
(DX-SX) 150: Vespa 59-66 • Vespa GL 63-64 • Vespa Super 66-79 • Vespa Sprint 65-74
(R.O. 070578)



18 410 0250 

(DX-SX) 125: Vespa Px T5 85-89
(R.O. 226792)



18 410 0251 

(DX-SX) 125: Vespa Ts 75-78 • Vespa Px 77-97 • Vespa Px 11 (R.O. 138836)
(SX) 125: Vespa Px 11
(DX-SX) 150: Vespa Px 77-97 • Vespa Pxe Arcobaleno 77-97
(DX-SX) 200: Vespa Pxe 77-97
(R.O. 138836)



18 410 0261 

(SX) 50: Vespa Pk FL 90 • Vespa Pk FL 2 Autom. 90-91 • Vespa Pk FL 2 Hp 91-97
(SX) 125: Vespa Pk FL 89-90
(R.O. 274546)



18 410 0300 

(SX) 50: Si FL2
(R.O. 268015)



18 410 0310 

(SX) 50: Si 90-91
(R.O. 228967)





LEVE
LEVERS

PIAGGIO

18 410 0531



(SX) 50: Nrg Extreme 99-00 • Nrg Mc3 01-04 • Zip 00-04 • Zip 4T 00-05 • Zip 4T 06-10 • Zip Sp 01-04 • Zip Sp Eu2 06-09
(SX) 125: Zip 00-02
(R.O. 562450)



18 410 0591



(SX) 50: Zip 00-04 • Zip 2T 08-10 • Zip 4T 06-10 • Zip Sp 01-04 • Zip Sp Eu2 06-09
(SX) 100: Zip 4T 06-10
(R.O. 564682)



18 410 0601



(SX) 50: Fly 2T 05-07 • Fly 4T 05-10 • Liberty 2T 06-08 • Liberty 4T 05-08 • Liberty 4T Sport 07-08 • Nrg Power Dt Serie Spec 07-08 • Typhoon 05-08 • Typhoon 09 • Vespa Lx 2T 05-08 • Vespa Lx 4T 05-08 • Vespa Lx 4T4V 09-10 • Vespa Lx 4T4V Touring 10-11
(SX) 100: Fly 4T 06-07
(SX) 125: Fly 05-07 • Fly Eu3 07-08 • Hexagon LxLxt 98-99 • Hexagon Lx4 98-99 • Liberty 4T 06-07 • Liberty Sport 06 • Vespa Lx 05-06 • Vespa Lx 4T FL 09 • Vespa Lx Eu3 06-08 • Vespa S 4T Eu3 07-08 • X9 01-02
(SX) 150: Fly 05-07 • Fly Eu3 08-10 • Liberty 4T Eu3 08 • Vespa Lx 05-06 • Vespa Lx Eu3 06-08 • Vespa Lx Touring 10-11 • Vespa S 4T 08-09 • Vespa S 4T le & College 09-11
(SX) 180: X9 Amalfi 00-03
(SX) 200: Liberty 06 • Liberty 4T Eu3 07-08 • Liberty 4T Sport Eu3 06-07 • Liberty Rst 04 • Liberty Sport 06
(R.O. 564683)



18 410 0731



(SX) 50: Liberty 4T Ptt 09-10 • Liberty 4T Delivery Tnt 09
(SX) 125: Liberty 4T Eu3 Delivery 08 • Liberty Rst Ptt 05-06
(R.O. 648083)



18 410 0821



(SX) 50: Vespa Lxv 2T Navy 08 • Lxv 2T 06-08
125: Lxv 4T Eu 3 06-09 • Lxv 4T Navy Eu 3 08 • Lxv le 4T 10-12
(R.O. 648115)



18 410 0881



(DX-SX) Vespa 50-125 Primavera Vma2t
(R.O. 147319)



18 410 0851



(SX) 125-150: X8 Street Eu 2 06-08
(R.O. 647552)



18 410 0861



(SX) 50: Typhoon 2T 10-12
125: Typhoon 4T 2V Eu 3 10-11 • Skipper Lx 98-99 Skipper 4T 00-02



18 410 0891



(DX-SX) Vespa 125 Vm1t/2 Vn1t/2tVna 1/2 1/2/3/4/5/6
Vespa 150 V11/2/3 Vb1Vba1Vbb1/2Vbc1
Vespa 150 Gs Vs1/2/3/4/5 Vespa 160 Gs Vsb Vespa 180 Ss Vsc
(R.O. 033882)



18 410 0901



(DX-SX) Vespa 50 V5a3V5b2/4 V5s1 Vespa Rally 180-200 VsdVse
(R.O. 120487)



18 410 0911



(SX) Vespa Px 125-150 My 11
(R.O. 2425314)



18 410 0941



(DX-SX) 50: Vespa mod. Sport Lucida Tutti i modelli - *All Models*
(R.O. 610285M)



18 410 0951



(DX-SX) 50: Vespa mod. Sport Nera Tutti i modelli - *All Models*
(R.O. 610286M)



18 410 0961



(SX) 50: Vespa FL 90 Vespa FL2 Automatica 90-91 Vespa FL2 Hp 91-97
(SX) 125: Vespa FL 89-90
(R.O. 265947)



- Terminale grosso - *Big end lever*
- Colore nero - *Black*
- Colore lucido - *Glossy*

- GRI Grimeca
- H.T. Heng Tong
- BRE Brembo

- DX Destra - *Right*
- SX Sinistra - *Left*

LEVE
LEVERS



PIAGGIO

18 410 0971 

(SX) 50: Vespa FL 90
Vespa FL2 Automatica 90-91
Vespa FL2 Hp 91-97
(SX) 125: Vespa FL 89-90
(R.O. 265947)



18 410 1060 

(SX-DX) 50: Ciao Sc
(R.O. 156378)



18 410 1100 

(SX) 50: Ciao Px
(R.O. 176945)



18 412 0091 

(DX) 50: Free Delivery 00-01 • Free FL 95-02
• Nrg 94-96 • Ntt 95-96 • Typhoon 01-04 • Zip
Rst Freno tamburo/*Drum* 96-99
(DX) 100: Free 02-03
(R.O. 564690)



18 412 0101 

(DX) 50: Nrg Rst Mc2 96-98
(R.O. 271449)



18 412 0111 

Impianto Grimeca - *Grimeca System*
(DX) 50: Nrg Extreme 99-00 • Nrg Mc3 01-04
• Zip 00-04 • Zip 4T 00-05 • Zip Sp 01-04
(DX) 125: Hexagon 94-97 • Hexagon Gtx 00 •
Hexagon Lx4 98-99 • Skipper 4T 00-02 • Skip-
per Lx 98-99 • Super Hexagon Gtx 12 01-02 •
Zip 00-02
(DX-SX) 50: Nrg Extreme 01-04 • Nrg Purejet
02-04 • Nrg Rst Mc2 96-98
(SX) 180: Hexagon Gtx 00
(R.O. 494952)



18 412 0231 

(DX) 50: Quartz 92-96 • Zip 95-96 • Zip Fast
Raider 93-94 • Zip Fast Raider Rst 96-97 • Zip
Rst Freno Disco/*Disc* 96-99 • Zip Sp 96-00
(DX) 125: Skipper 94-97
(R.O. 494951)



18 412 0261 

Impianto Grimeca - *Grimeca System*
(DX) 50: Liberty 97-05 • Liberty 4T 00-02
• Vespa Et2 97-05 • Vespa Et2 Iniezione 97-00
• Vespa Et4 00-05
(DX) 125: Liberty 98-02 • Vespa Et4 96-02
(R.O. 494948)



18 412 0281 

(DX) 50: Vespa Pk FL 90 • Vespa Pk FL 2
Autom. 90-91 • Vespa Pk FL 2 Hp 91-97
(R.O. 274546)



18 412 0291 

(DX) 50: Vespa Pk FL 90 • Vespa Pk FL 2
Autom. 90-91 • Vespa Pk FL 2 Hp 91-97
(DX) 125: Vespa Pk FL 88-90
(R.O. 274546)



18 412 0330 

(DX) 50: Si FL2
(R.O. 268014)



18 412 0531 

Impianto Grimeca Abs - *Grimeca Abs System*
(DX-SX) 500: X9 Evolution 03-05 • X9 Evolu-
tion Abs 06-07
(R.O. 600829)





LEVE
LEVERS

PIAGGIO

18 412 0601 

Impianto Brembo - *Brembo System*
(DX-SX) 200: Beverly 01-03 • Carnaby 07-08
(DX-SX) 125: Beverly 01-03 • Beverly Eu3 07-08 • Beverly Eu3 Mic 07 • Beverly Rst 06-07 • Beverly Tourer Eu3 08-09 • Carnaby 07-09
(DX-SX) 200: X9 02-03
(DX-SX) 250: Beverly Eu3 Mic 07 • Beverly Le Eu3 06-08 • Beverly Rst 0405
(DX-SX) 400: Beverly Eu3 0607 • Beverly Tourer Eu3 08-09
(DX-SX) 500: Beverly 05-06 • Beverly Eu3 06-08 • X9 Evolution 03-05
(DX) 125: Beverly Eu3 Sport 07-08
(DX) 180: X9 Amalfi 00-03
 (R.O. 646829)



18 412 0641 

Impianto Heng Tong - *Heng Tong System*
(DX) 50: Liberty 97-05 • Liberty 4T 00-02 • Liberty Ptt Eu2 04-05 • Vespa Et2 97-05 • Vespa Et4 00-05
(DX) 125: Liberty 01-02 • Vespa Et4 99-02
 (R.O. 497039)



18 412 0651 

Impianto Heng Tong - *Heng Tong System*
(DX-SX) 50: Nrg Mc3 01-04 • Nrg Power Purejet 04-05 • Nrg Purejet 02-04
(DX) 50: Typhoon 2T Eu2 10-11 • Zip 4T 06-10 • Zip Sp 01-04 • Zip Sp Eu2 06-09
(DX) 125: Skipper 4T 00-02 • Super Hexagon Gtx 12 01-02 • Typhoon 4T 2V Eu3 10-11
 (R.O. 497041)



18 412 0652 

Impianto Heng Tong - *Heng Tong System*
(DX) 50: Fly 2T 10 • Fly 4T 05-07 • Liberty 2T 06-08 • Liberty 4T 05-08 • Nrg Power Dt 06-11 • Vespa Lx 2T 05-08 • Vespa Lx 4T 05-08 • Vespa Lx 4T 4V 09-10 • Vespa Lx 4T 4V Touring 10-11 • Vespa S 4T4V & College 08-11
(DX-SX) 50: Nrg Power Dd 07-10 • Nrg Power Purejet 07-11 • Nrg Purejet 10
(DX) 100: Fly 4T 06-07
(DX) 125: Fly 05-07 • Fly Eu3 08 • Liberty 4T 06-07 • Liberty 4T Eu3 07-08 • Liberty Rst Ptt 05-06 • Liberty Sport 06 • Vespa Gts Eu3 07-10 • Vespa Lx 05-06 • Vespa Lx 4T FL 09 • Vespa Lx Eu3 06-08 • Vespa Lx Touring 10-11 • Vespa S 4T Eu3 07-08
(DX) 150: Fly 05-07 • Fly Eu3 08-10 • Liberty 4T Eu3 08 • Vespa Lx 05-06 • Vespa Lx 4T FL 09 • Vespa Lx Eu3 ie 09-11 • Vespa Lx Touring 10-11 • Vespa S 4T 08-09
(DX) 200: Liberty 06 • Liberty 4T Eu3 07-08 • Liberty 4T Sport Eu3 06-07 • Liberty Sport 06
(DX) 300: Vespa Gts Super Sport 10
(DX-SX) 125: Vespa Granturismo 03-05
 (R.O. 646833)



18 412 0661 

Impianto Heng Tong - *Heng Tong System*
(DX-SX) 125: Beverly 01-03 • Beverly Eu3 07-08 • Beverly Eu3 Mic 07 • Beverly Eu3 Sport 07-08 • Beverly Rst 04-07 • Beverly Tourer Eu3 08-09 • Carnaby 07-09 • X7 Evo Ie Eu3 09-10 • X9 Evolution 05-07 • X9 Evolution Eu3 07 • X7 Eu3 08
(SX) 125: Mp3 07-08 • Mp3 Ibrido 09-10 • Mp3 Ie 08-09 • Mp3 Yourban Erl 11
(DX-SX) 200: Beverly 01-03 • Carnaby 07-08 • X8 05-07
(DX-SX) 250: Beverly 06-07 • Beverly Eu3 Mic 07 • Beverly Ie Eu3 06-08 • Beverly Rst 04-05 • Beverly Sport 06-08 • Beverly Tourer Eu3 08-09 • Carnaby 08
(DX-SX) 300: Beverly Tourer Eu3 09-10 • Carnaby Cruiser 09-11 • X7 Evo Ie Eu3 09-10
(SX) 400: Beverly Eu3 06-07 • Beverly Tourer Eu3 08-09 • Mp3 07-08 • Mp3 Ie Lt Touring 11 • Mp3 Ie Lt Sport 08-10 • Mp3 Mic 08-11 • X Evo 07-11 • X8 Eu3 06-08
(SX) 500: Beverly 05-06 • Beverly Eu3 06-08
 (R.O. 600475)



18 412 0711 

Impianto Heng Tong - *Heng Tong System*
(DX) 50: Fly 2T 10 • Fly 4T 05-10 • Liberty 2T 06-08 • Liberty 4T 05-08 • Liberty 4T Ptt 09-10 • Liberty 4T Delivery Tnt 09 • Liberty 4T Sport 07-08 • Nrg Power Dt 06-11 • Typhoon 05-08 • Typhoon 09 • Vespa Lx 2T 05-08 • Vespa Lx 2T FL 09-10 • Vespa Lx 2T Touring 10-11 • Vespa Lx 4T 05-08 • Vespa Lx 4T4V 09-10 • Vespa Lx 4T4V Touring 10-11
(DX-SX) 50: Nrg Power Dd 05-06 • Nrg Power Dd 07-10 • Nrg Power Dd Serie Spec 07-10 • Nrg Power Purejet 06-08 • Nrg Purejet 10
(DX) 100: Fly 4T 06-07
(DX-SX) 125: Vespa Granturismo 06-07 • Vespa Granturismo Eu3 06-07 • Vespa Gts 4T ie Super 09-11 • Vespa Gts Eu3 07-10
(DX) 125: Fly 05-07 • Fly Eu3 08 • Liberty 4T 06-07 • Liberty Moc 4T & Elle 09-10 • Liberty Sport 06 • Vespa Lx 05-06 • Vespa Lx 4T FL 09 • Vespa Lx Eu3 06-08 • Vespa Lx Eu3 ie 09-10 • Vespa Lx Touring 10-11 • Vespa S 4T Eu3 07-08
(DX) 150: Fly 05-07 • Fly Eu3 08-10 • Liberty 4T Eu3 08 • Liberty 4T Sport Eu3 08 • Liberty Moc 4T 09-10 • Vespa Lx 05-06 • Vespa Lx 4T FL 09 • Vespa Lx Eu3 06-08 • Vespa Lx Eu3 ie 09-11 • Vespa Lx Touring 10-11 • Vespa S 4T 08-09 • Vespa S 4T Ie & College 09-11
(DX) 200: Liberty 06 • Liberty 4T Sport Eu3 06-07 • Liberty Rst 04 • Liberty Sport 06
(DX-SX) 300: Vespa Gts ie Touring 11 • Vespa Gts Super 08-10
(DX-SX) 200: Vespa Granturismo 06-07
 (R.O. 497042)



● Terminale grosso - Big end lever
■ Colore nero - Black
□ Colore lucido - Glossy

GRI Grimeca
H.T. Heng Tong
BRE Brembo

DX Destra - Right
SX Sinistra - Left

LEVE
LEVERS



PIAGGIO

18 412 0721



Impianto Brembo - *Brembo System*

(DX-SX) 200: Beverly 01-03 • Carnaby 07-08
(DX-SX) 125: Beverly 01-03 • Beverly Eu3 07-08 • Beverly Eu3 Mic 07 • Beverly Rst 06-07 • Beverly Tourer Eu3 08-09 • Carnaby 07-09
(DX-SX) 200: X9 02-03
(DX-SX) 250: Beverly Eu3 Mic 07 • Beverly ie Eu3 06-08 • Beverly Rst 04-05
(DX-SX) 400: Beverly Eu3 06-07 • Beverly Tourer Eu3 08-09
(DX-SX) 500: Beverly 05-06 • Beverly Eu3 06-08 • X9 Evolution 03-05
(DX) 125: Beverly Eu3 Sport 07-08
(DX) 180: X9 Amalfi 00-03

18 412 0731



Impianto Grimeca - *Grimeca System*

(DX) 50: Fly 2T 05-07 • Fly 2T 10 • Fly 4T 05-07 • Fly 4T Mot Chn 06-07 • Liberty 2T 06-08 • Liberty 2T Rst 04 • Liberty 2T Sport 06-08 • Liberty 4T 05-08 • Liberty 4T Rst 04 • Liberty 4T Sport 06-08 • Liberty Moc 2T 09-10 • Liberty Moc 4T & Elle 09-10 • Nrg Power Dd Serie Spec 07-10 • Nrg Power Dt 06-08 • Nrg Power Dt Serie Spec 07-08 • Vespa Lx 2T 05-08 • Vespa Lx 4T 05-08 • Vespa S 2T & College 07-11 • Vespa S 4T4V & College 08-11
(DX) 100: Fly 4T 06-07
(DX) 125: Fly 05-07 • Fly Eu3 07 • Fly Eu3 08 • Hexagon LxLxt 98-99 • Hexagon Lx4 98-99 • Liberty 4T 06-07 • Liberty 4T Eu3 07-08 • Liberty 4T Eu3 Delivery 08 • Liberty 4T Sport Eu3 06-08 • Liberty Rst Ptt 05-06 • Liberty Sport 06 • Vespa Lx 05-06 • Vespa Lx Eu3 06-08 • Vespa S 4T Eu3 07-08
(DX) 150: Fly 05-07 • Fly Eu3 08-10 • Liberty 4T Eu3 08 • Liberty 4T Sport Eu3 08 • Vespa Lx 05-06 • Vespa Lx Eu3 06-08
(DX) 200: Liberty 06 • Liberty 4T Eu3 07-08 • Liberty 4T Sport Eu3 06-07 • Liberty Sport 06
(SX) 250: Hexagon GtGtx 98-00 • Vespa Gts, Gts Abs 05-10
(R.O. 646803)

18 412 0791



(DX) 125: Vespa Px 11 • Vespa Px 11 • Vespa Px Millenium 07-08
(DX) 200: Vespa Px F. Disco 98-01
(R.O. 494804)



18 412 0911



50: Vespa Hp



18 412 0921



(DX-SX) 250: Beverly Cruiser 07-09
500: Beverly Cruiser 07-12
(R.O. 649196)



18 412 1001



Impianto Heng Tong - *Heng Tong System*
(DX-SX)
300: Carnaby Cruiser 09-12
(R.O. 665870)



18 412 1070



(DX) 50: Ciao Px
(R.O. 177340)



18 412 1080



(DX) 50: Si 90-91
(R.O. 228966)



18 414 0050



LEVA DECOMPRESSORE

PIAGGIO 50: Bravo Erre 2 75-81 • Ciao 80-88 • Si 79-88 • Superbravo 85-90
(R.O. 176946)



18 414 0060



LEVA DECOMPRESSORE

PIAGGIO 50: Ciao • Si
(R.O. 268099)





LEVE
LEVERS

SUZUKI

18 410 0521



(SX) 125: Uh Burgman K2K6 02-03 • Uh Burgman K7L0 07-10 • Uh Burgman L1 11 • Ux Sixteen K8L0 08-10 • Ux Sixteen L1 11

(SX) 150: Uh Burgman K2K6 02-03 • Ux Sixteen K8L0 08-10 • Ux Sixteen L1 11

(SX) 200: Uh Burgman K7L0 07-10 • Uh Burgman L1 11

(SX) 250: An Burgman K3K6 03-06 • An Burgman WK2 98-02

(SX) 400: An Burgman K3K6 03-06 • An Burgman K7L0 07-10 • An Burgman L1 11 • An Burgman XK2 99-02

(R.O. 5750014F00000)

18 412 0621



(DX) 50: Aj Zz Sepia S 95-97

(DX) 110: Ug Hokuto 00

(DX) 125: An SY 95-00 • Uc Epicuro XK1 99-01

(DX) 150: AntY 96-00 • Uc Epicuro XK1 99-01

(R.O. 5742129C00000)

18 412 0631



(DX) 125: Uh Burgman K2K6 02-03 • Uh Burgman K7L0 07-10 • Uh Burgman L1 11 • Ux Sixteen K8L0 08-10 • Ux Sixteen L1 11

(DX) 150: Uh Burgman K2K6 02-03 • Ux Sixteen K8L0 08-10 • Ux Sixteen L1 11

(DX) 200: Uh Burgman K7L0 07-10 • Uh Burgman L1 11

(DX) 250: An Burgman K3 K6 03-06 • An Burgman WK2 98-02

(DX) 400: An Burgman K3 K6 03-06 • An Burgman K7L0 07-10 • An Burgman L1 11 • An Burgman XK2 99-02

(R.O. 5742114F00000)



YAMAHA

18 410 0010



(SX) 50: Bw'S Tamburo - Drum



18 410 0131



(SX) 50: Cr Z 91-95 • Ct S/Ss 90-95

(R.O. 1NTH391200)



18 410 0141



(SX) 50: Yn Neo'S/Eu2 97-06

(SX) 100: Yn Neo'S 00-01

(R.O. 5ADH391202)



18 410 0151



(SX) 50: Ya R Axis 95 • Ym Breeze 94-95

(R.O. 4KHH391200)



18 410 0161



(SX) 50: Bw'S Bump 97-98 • Bw'S Ng 97-98 •

Bw'S Original S. Special 99-00 • Cw Rs Spy 95-98

(R.O. 4SBH391200)



18 410 0401



(SX) 50: Bw'S 04-09 • Bw'S 10-11 • Bw'S Naked

03 • Bw'S Naked 04 • Bw'S Naked 09-11 • Bw'S

Ng 01-06 • Bw'S Original/Eu2 01-03 • Bw'S R 01

• Cw Bw'S L 03 • Cw Bw'S L 04 • Cw Bw'S Original

Eu2 02 • Cw Bw'S Original Sp 02 • Cs Jog R

02-11 • Cs Jog R Eu2 02-09 • Ew Slider 00-02 •

Yn Neo'S 07-11 • Yn F Neo's \$ 09-11

(R.O. 5JHH391200)



18 410 0411



(SX) 50: Yh Why/Eu1/Eu2 98-09

(R.O. 5EUH391200)



18 410 0421



(SX) 50: Bw'S Ng Cat 99-00 • Bw'S Original

97-98 • Bw'S Original 99-00

(R.O. 4SBH391210)



18 410 0491



(SX) 125: Xn Teo'S 00-01 • Yp Majesty 99-00

(SX) 150: Xn Teo'S 00-02 • Yp Majesty 00

(R.O. 5DSH391201)



● Terminale grosso - *Big end lever*
■ Colore nero - *Black*
□ Colore lucido - *Glossy*

GRI Grimeca
H.T. Heng Tong
BRE Brembo

DX Destra - *Right*
SX Sinistra - *Left*

LEVE
LEVERS



YAMAHA

18 410 0501 

(SX) 250: Yp Majesty 00-03 • Yp Majesty
(DX) 98-00 • Yp Majesty/Abs 00-06
(R.O. 5CG8391100)



18 410 0561 

(SX) 400: Yp Majesty 04-08
(SX) 500: Xp TMax/Ie/Abs/Black 01-07
(R.O. 5GJ8391200)



18 410 0621 

(SX) 125: Vp XCity 08-10 • Yp R XMax 06-10
(SX) 250: Vp XCity 07-10 • Yp R XMax/Black
05-10
(R.O. 1B9H392200)



18 410 0781 

(SX) 125: Nxc Cygnus X 04-11
(R.O. 5MLH39121000)



18 410 0791 

(SX) 400: Yp Majesty 09-11
500: Xp T Max 08-11
530: Xp T Max 12-13



18 410 0801 

(SX) Bw's 100 99-01 • Yw Bw's 125 10
(R.O. 4VPH39121000)



18 410 1051 

(SX) 400: X-Max 13>
(R.O. 1SDH391200)



18 412 0010 

(DX) 50: Bw'S Tamburo - *Drum*
(R.O. 3VLH39221000)



18 412 0151 

(DX) 50: Cr Z 9195 • Ya R Axis 95 • Ya Za Jog Z
95-96 • Ym Breeze 94-95
(R.O. 2NA8392201)



18 412 0161 

(DX) 50: Bw'S Original 97-98
(R.O. 4VVH392200)



18 412 0171 

(DX) 50: Bw'S Bump 97-98 • Bw'S Ng 97-98
(R.O. 4SBH392200)



18 412 0181 

(DX) 50: Cw Rs Spy 95-98
(R.O. 4TDH392200)



18 412 0391 

(DX-SX) 50: Yq Aerox L/R/Eu2 97-08 • Yq Aerox
R Replica 08
(R.O. 5BRH39120100)



18 412 0401 

(DX) 50: Yn Neo'S/Eu2 97-06
(DX) 100: Yn Neo'S 00-01
(R.O. 5ADH392201)



18 412 0471 

(DX) 50: Bw'S Original 99-00
(R.O. 4VVH392210)





LEVE
LEVERS

YAMAHA

18 412 0481



(DX) 50: Bw'S 04-09 • Bw'S 10-11 • Bw'S Naked 04 • Bw'S Naked 09-11 • Bw'S Ng 01-06 • Cw Bw'S L 04 • Ew Slider 00-02
(R.O. 5JHH392200)



18 412 0491



(DX) 50: Yh Why/Eu1/Eu2 98-09
(R.O. 5EUH392200)



18 412 0511



(DX) 50: Bw'S Ng Cat 99-00
(R.O. 45BH392210)



18 412 0561



(DX) 400: Yp Majesty 04-08
(DX) 500: Xp TMax/Ie/Abs/Black 01-07
(R.O. 5GJ8392200)



18 412 0601



(DX-SX) 125: Xq Maxster 01-02 • Yp Majesty 01-09 • Yp Majesty E 01-09
(DX-SX) 150: Xq Maxster 01-02 • Yp Majesty 01-02
(SX) 300: Vp Versity/Xc 03-08
(R.O. 5DSH392201)



18 412 0611



(DX) 250: Yp Majesty 00-03 • Yp Majesty (DX) 98-00 • Yp Majesty/Abs 00-06
(R.O. 5CG8392201)



18 412 0751



(DX) 125: Vp XCity 08-10 • Yp R XMax 06-10
(DX) 250: Vp XCity 07-10 • Yp R XMax/Black 05-10
(R.O. 1B9H391200)



18 412 0821



(DX) 50: Bw's Naked 03 • Bw's Original Eu 2 03 • Bw's Original 01-02 • Bw's R 01 • Cw Bw's Original Eu 2 02 • Cw L Bw's 03 • Cw Sp Bw's Original Eu 2 02
(R.O. 5NTH39220000)



18 412 0841



(DX-SX) 50: Yq Aerox 09-12
(R.O. 3C6H39120000)



18 412 0851



(DX) 400: Yp Majesty Abs 09-11 • Yp Majesty 09-11
500: Xp TMax Abs Sv 11 • Xp TMax Abs 08-11 • Xp TMax Sv 11 • Xp TMax White Max 10 • Xp TMax 08-11
530: Xp TMax Abs 12 • Xp TMax 12
(R.O. 4B5839220000)



18 412 0871



(DX) 125: Nxc Cygnus X 04-11
(R.O. 5MLH39220000)



18 412 0891



(DX) 50: Cs Jog R Eu 2 02-05 Cs Jog R 02-11
(R.O. 5RWH392200)



18 412 1011



(DX) 400: X-Max 13>
(R.O. 1SDH392200)



● Terminale grosso - Big end lever
 ■ Colore nero - Black
 □ Colore lucido - Glossy

GRI Grimeca
 H.T. Heng Tong
 BRE Brembo

DX Destra - Right
 SX Sinistra - Left

LEVE
LEVERS



CC	MODELLO - MODEL	ANNO YEAR	COLORE - COLOUR	SINISTRA - LEFT		IMPIANTO SYSTEM	TERMINALE TERMINAL	DESTRA - RIGHT		IMPIANTO SYSTEM	TERMINALE TERMINAL
				CODICE RMS RMS CODE	RIF. ORIGINALE OEM NUMBER			CODICE RMS RMS CODE	RIF. ORIGINALE OEM NUMBER		
APRILIA											
50	Amico	92	■	18 410 0010				18 412 0010			
50	Amico	94	■	18 410 0021	AP8218153						
50	Amico	96-98	■	18 410 0021	AP8218153			18 412 0021	AP8218156	Gri.	
50	Amico	96-98	□	18 410 0061	AP8218274			18 412 0051	AP8218273	Gri.	
50	Amico Gl-Gle	93-95	■	18 410 0021	AP8218153			18 412 0021	AP8218156		
50	Amico Lx- Sport-Cat	92-93	■	18 410 0021	AP8218153			18 412 0021	AP8218156		
50	Gulliver - S	95	■	18 410 0021	AP8218153						
50	Gulliver - T/V/W	96-98	□	18 410 0061	AP8218274						
50	Gulliver Lc	96-98	□	18 410 0061	AP8218274			18 412 0061	AP8218288	Gri.	
50	Mojito Retro - Habana	99-03	□	18 410 0061	AP8218274			18 412 0061	AP8218288	Gri.	
50	Mojito Custom 2T Mot. Piaggio	04-10	□	18 410 1001	AP8218495			18 412 0941	AP8218479		
50	Mojito Custom	99-03	□	18 410 1001	AP8218495			18 412 0941	AP8218479		
50	Rally	94-95	■	18 410 0021	AP8218153			18 412 0021	AP8218156	Gri.	
50	Rally	96-98	□	18 410 0061	AP8218274			18 412 0051	AP8218273	Gri.	
50	Rally	01-03	■	18 410 0021	AP8218153			18 412 0021	AP8218156	Gri.	
50	Rally Lc	96-99	□	18 410 0031	AP8213279			18 410 0031	AP8213279		
50	Scarabeo Tamb+Tamb	93-97	■	18 410 0041	AP8218176			18 412 0041	AP8218172		
50	Scarabeo Disc+Tamb	93-96	■	18 410 0041	AP8218176			18 412 0021	AP8218156	Gri.	
50	Scarabeo Disc+Tamb	97	□	18 410 0051	AP8218329			18 412 0051	AP8218273	Gri.	
50	Scarabeo Disc+Disc	98-05	□	18 410 0071	AP8118461			18 412 0051	AP8218273	Gri.	
50	Scarabeo Disc+Tamb	99-05	□	18 410 0051	AP8218329			18 412 0051	AP8218273	Gri.	
50	Scarabeo 4T	02-06	□		AP8218570			18 412 0051	AP8218273	Gri.	
50	Scarabeo 4T 4V Net	10	□		AP8218570			18 412 0931	AP8218640	H.T.	
50	Scarabeo 4T 4V	10-12	□		AP8218570			18 412 0711	497042	H.T.	
50	Scarabeo 4T Rst Eu3	06-09	□		AP8218570			18 412 0051	AP8218273	Gri.	
50	Scarabeo Ditech	01-04	□	18 410 0071	AP8118461			18 412 0931	AP8218640	H.T.	
50	Scarabeo 2T Net	10	□		AP8218570			18 412 0051	AP8218273	Gri.	
50	Scarabeo 2T Net	09	□		AP8218570			18 412 0931	AP8218640	H.T.	
50	Scarabeo 2T Eu2 Mot. Piaggio	10-12	□		AP8218570			18 412 0051	AP8218273	Gri.	
50	Scarabeo Quattro	09	□		AP8218570			18 412 0931	AP8218640	H.T.	
50	Scarabeo Street	05-06	□		AP8218570			18 412 0051	AP8218273	Gri.	
50	Scarabeo Street 2T Rst	06-09	□		AP8218570			18 412 0931	AP8218640	H.T.	
50	Sonic	98-07	□	18 410 0061	AP8218274			18 412 0061	AP8218288	Gri.	
50	Sonic Gp	98-08	□	18 410 0061	AP8218274			18 412 0061	AP8218288	Gri.	
50	Sport City One 2T/4T	08-11	■	18 410 0861	564681			18 412 0651	497041	H.T.	
50	Sr	93-95	■	18 410 0021	AP8218153			18 412 0021	AP8218156	Gri.	
50	Sr	96	□	18 410 0061	AP8218274			18 412 0051	AP8218273	Gri.	
50	Sr Motard	12-13	■	18 410 0861	564681			18 412 0651	497041	H.T.	
50	Sr Ditech Eu2	02-03	■	18 412 0501	AP8218549	Gri.		18 412 0501	AP8218549	Gri.	
50	Sr H2O Ditech E Carb.	00-03	■	18 410 0021	AP8218153			18 412 0501	AP8218549	Gri.	
50	Sr H2O Ditech E Carb.	00-03	■	18 412 0501	AP8218549	Gri.		18 412 0501	AP8218549	Gri.	
50	Sr Liquid Cooled	94-95	■	18 410 0021	AP8218153			18 412 0021	AP8218156	Gri.	
50	Sr Liquid Cooled	96	□	18 410 0061	AP8218274			18 412 0051	AP8218273	Gri.	



LEVE LEVERS

CC	MODELLO - MODEL	ANNO YEAR	COLORE - COLOUR	SINISTRA - LEFT		IMPIANTO SYSTEM	TERMINALE TERMINAL	DESTRA - RIGHT		IMPIANTO SYSTEM	TERMINALE TERMINAL
				CODICE RMS RMS CODE	RIF. ORIGINALE OEM NUMBER			CODICE RMS RMS CODE	RIF. ORIGINALE OEM NUMBER		
50	Sr R Factory Ie E Carb.	10-14	■	18 410 0571	AP8213601	H.T.		18 410 0571	AP8213602	H.T.	
50	Sr R Factory Ie E Carb.	10-11	■	18 410 0581	AP8590035	Gri.		18 410 0581	AP8590035	Gri.	
50	Sr R Factory Mot Aprilia	05	■	18 410 0571	AP8213601	H.T.		18 410 0571	AP8213601	H.T.	
50	Sr R Factory Mot Aprilia	05	■	18 410 0581	AP8590035	Gri.		18 410 0581	AP8590035	Gri.	
50	Sr R R Factory	04-09	■	18 410 0571	AP8213601	H.T.		18 410 0571	AP8213601	H.T.	
50	Sr R R Factory	04-09	■	18 410 0581	AP8590035	Gri.		18 410 0581	AP8590035	Gri.	
50	Sr Stealth, Racing	97-99	□	18 410 0061	AP8218274			18 412 0061	AP8218288	Gri.	
50	Sr Stealth, Racing	97	□	18 412 0061	AP8218288	Gri.		18 412 0061	AP8218288	Gri.	
50	Sr Street	03-11	■	18 412 0501	AP8218549	Gri.		18 412 0501	AP8218549	Gri.	
50	Sr Street	03-12	■	18 412 0971	AP8213597			18 412 0971	AP8213597		
50	Sr Www	97-99	□	18 410 0061	AP8218274			18 412 0061	AP8218288	Gri.	
50	Sr Iniezione/Carburatore	14	■	18 412 0661	600475	H.T.		18 412 0661	600475	H.T.	
50	Sr R Factory Iniezione/Carburatore	10-14	■	18 412 0661	600475	H.T.		18 412 0661	600475	H.T.	
50	Sr Street	03-12	■	18 412 0661	600475	H.T.		18 412 0661	600475	H.T.	
100	Scarabeo 4T	01-04	□		AP8218570			18 412 0051	AP8218273	Gri.	
100	Scarabeo 4T	10-12	□		AP8218570			18 412 0711	497042	H.T.	
100	Scarabeo 4T Net	10	□		AP8218570			18 412 0051	AP8218273	Gri.	
100	Scarabeo 4T Net Eu3	10	□		AP8218570			18 412 0931	AP8218640	H.T.	
100	Scarabeo 4T Rst	06-09	□		AP8218570			18 412 0711	497042	H.T.	
100	Scarabeo Mot Minarelli	00	□	18 410 0051	AP8218329			18 412 0051	AP8218273	Gri.	
125	Leonardo	96-98	□	18 410 0071	AP8118461			18 412 0051	AP8218273	Gri.	
125	Sport City Eu3	06-08	■	18 410 0571	AP8213601	H.T.		18 410 0571	AP8213602	H.T.	
125	Sport City Eu3	06-08	■	18 410 0581	AP8590035	Gri.		18 410 0581	AP8590035	Gri.	
125	Mojito	08	□	18 410 1001	AP8218495			18 412 0941	AP8218479	Gri.	
125	Mojito Custom	99-07	□	18 410 1001	AP8218495			18 412 0941	AP8218479	Gri.	
125	Mojito Retro'	99-07	□	18 410 0061	AP8218274			18 412 0061	AP8218288	Gri.	
125	Scarabeo Mot Rotax	99-01	□	18 412 0521	AP8118542			18 412 0521	AP8118542		
125	Sport City	04-06	■	18 410 0571	AP8213601	H.T.		18 410 0571	AP8213602	H.T.	
125	Sport City	04-06	■	18 410 0581	AP8590035	Gri.		18 410 0581	AP8590035	Gri.	
125	Sport City One 4T Eu3	08-11	■	18 410 0861	564681			18 412 0651	497041	H.T.	
125	Sr	00	■	18 410 0021	AP8218153			18 412 0501	AP8218549	Gri.	
125	Sr	99	□	18 410 0061	AP8218274			18 412 0061	AP8218288	Gri.	
125	Sr Motard	12-13	■	18 410 0861	564681			18 412 0651	497041	H.T.	
125	Atlantic Eu3	06-08	■	18 410 0771	AP8133809	H.T.		18 410 0771	AP8133809	H.T.	
125	Atlantic Eu3	10-12	■	18 410 0771	AP8133809	H.T.		18 410 0771	AP8133809	H.T.	
125	Atlantic	03-05	■	18 410 0771	AP8133809	H.T.		18 410 0771	AP8133809	H.T.	
125	Scarabeo Ie Light	11-12	■	18 410 0771	AP8133809	H.T.		18 410 0771	AP8133809	H.T.	
125	Scarabeo Ie Light	09-10	■	18 410 0771	AP8133809	H.T.		18 410 0771	AP8133809	H.T.	
125	Scarabeo Light	07-08	■	18 410 0771	AP8133809	H.T.		18 410 0771	AP8133809	H.T.	
125	Scarabeo Mot. Piaggio Eu3	06	■	18 410 0771	AP8133809	H.T.		18 410 0771	AP8133809	H.T.	
125	Scarabeo	04-06	■	18 410 0771	AP8133809	H.T.		18 410 0771	AP8133809	H.T.	
125	Sport City Cube	08-10	■	18 410 0771	AP8133809	H.T.		18 410 0771	AP8133809	H.T.	
125	Sr Max	11-14	■	18 412 0661	600475	H.T.		18 412 0661	600475	H.T.	
150	Leonardo	96-98	□	18 410 0071	AP8118461			18 412 0051	AP8218273	Gri.	
150	Sr	00	■	18 410 0021	AP8218153			18 412 0501	AP8218549	Gri.	
150	Sr	99	□	18 410 0061	AP8218274			18 412 0061	AP8218288	Gri.	

● Terminale grosso - Big end lever
 ■ Colore nero - Black
 □ Colore lucido - Glossy

GRI Grimeca
 H.T. Heng Tong
 BRE Brembo

DX Destra - Right
 SX Sinistra - Left

LEVE
LEVERS



CC	MODELLO - MODEL	ANNO YEAR	COLORE - COLOUR	SINISTRA - LEFT		IMPIANTO SYSTEM	TERMINALE TERMINAL	DESTRA - RIGHT		IMPIANTO SYSTEM	TERMINALE TERMINAL
				CODICE RMS RMS CODE	RIF. ORIGINALE OEM NUMBER			CODICE RMS RMS CODE	RIF. ORIGINALE OEM NUMBER		
200	Scarabeo Mot Rotax	99-01	□	18 412 0521	AP8118542			18 412 0521	AP8118542		
200	Sport City	04-06	■	18 410 0571	AP8213601	H.T.		18 410 0571	AP8213602	H.T.	
200	Sport City	04-06	■	18 410 0581	AP8590035	Gri.		18 410 0581	AP8590035	Gri.	
200	Scarabeo le Light	11-12	■	18 410 0771	AP8133809	H.T.		18 410 0771	AP8133809	H.T.	
250	Leonardo	99-04	□	18 412 0531	AP8218480			18 412 0531	AP8218480		
250	Atlantic Eu3	06-08	■	18 410 0771	AP8133809	H.T.		18 410 0771	AP8133809	H.T.	
250	Scarabeo Light	06-08	■	18 410 0771	AP8133809	H.T.		18 410 0771	AP8133809	H.T.	
250	Sport City Cube	08-10	■	18 410 0771	AP8133809	H.T.		18 410 0771	AP8133809	H.T.	
300	Sport City Street	12	■	18 410 0571	AP8213601	H.T.		18 410 0571	AP8213602	H.T.	
300	Atlantic	10-11	■	18 410 0771	AP8133809	H.T.		18 410 0771	AP8133809	H.T.	
300	Scarabeo Light	09-10	■	18 410 0771	AP8133809	H.T.		18 410 0771	AP8133809	H.T.	
300	Sr Max	11-14	■	18 412 0661	600475	H.T.		18 412 0661	600475	H.T.	
400	Atlantic Sprint	05-08	■	18 410 0771	AP8133809	H.T.		18 410 0771	AP8133809	H.T.	
400	Scarabeo Light	06-08	■	18 410 0771	AP8133809	H.T.		18 410 0771	AP8133809	H.T.	
500	Atlantic	01-04	□	18 412 0521	AP8118542			18 412 0521	AP8118542		
500	Scarabeo	03-06	□	18 412 0521	AP8118542			18 412 0521	AP8118542		
500	Atlantic Sprint	05-08	■	18 410 0771	AP8133809	H.T.		18 410 0771	AP8133809	H.T.	
500	Scarabeo Light	06-08	■	18 410 0771	AP8133809	H.T.		18 410 0771	AP8133809	H.T.	
660	Pegaso Strada (Fun) - T	05-09	□					18 412 0841	AP8218479		
DERBI											
50	Boulevard 2T	09-10	□	18 410 0601	564683		●	18 412 0731	646803	Gri.	●
50	Boulevard 4T	09-10	□	18 410 0601	564683		●	18 412 0731	646803	Gri.	●
50	Boulevard 2T	09-10	□	18 410 0601	564683		●	18 412 0652	646833	H.T.	
50	Boulevard 4T	09-10	□	18 410 0601	564683		●	18 412 0711	497042	H.T.	
50	Sonar 2T	10-11	□	18 410 0601	564683		●	18 412 0652	646833	H.T.	
50	Variant Sport 2T	12	■	18 410 0861	564681			18 412 0651	497041	H.T.	
100	Boulevard 4T	10	□	18 410 0601	564683		●	18 412 0731	646803	Gri.	●
100	Boulevard 4T	10	□	18 410 0601	564683		●	18 412 0652	646833	H.T.	
125	Variant Sport 4T Eu3	12	■	18 410 0861	564681			18 412 0651	497041	H.T.	
125	Boulevard	02-07	■	18 410 0861	564681						
150	Boulevard Euro 3 - II Vers.	10	□	18 410 0601	564683		●	18 412 0731	646803	Gri.	●
150	Boulevard Euro 3	11-10	□	18 410 0601	564683		●	18 412 0711	497042	H.T.	
150	Boulevard	02-07	■	18 410 0861	564681						
125	Rambla -Eu3 - II Vers.	08-09	■	18 410 0581	AP8590035	Gri.		18 410 0581	AP8590035	Gri.	
125	Rambla -Eu3 - II Vers.	08-09	■	18 410 0571	AP8213601	H.T.		18 410 0571	AP8213602	H.T.	
125	Sonar 4T	09	□	18 410 0601	564683		●	18 412 0711	497042	H.T.	
150	Sonar 4T	09	□	18 410 0601	564683		●	18 412 0711	497042	H.T.	
200	Boulevard	05	■	18 410 0861	564681						
250	Rambla -Eu3 - II Vers.	08-09	■	18 410 0581	AP8590035	Gri.		18 410 0581	AP8590035	Gri.	
250	Rambla -Eu3 - II Vers.	08-09	■	18 410 0571	AP8213601	H.T.		18 410 0571	AP8213602	H.T.	
300	Rambla	10-11	■	18 410 0581	AP8590035	Gri.		18 410 0581	AP8590035	Gri.	
300	Rambla	10-11	■	18 410 0571	AP8213601	H.T.		18 410 0571	AP8213602	H.T.	
GILERA											
50	Dna	00-07	■	18 412 0721	497031	Bre.	●	18 412 0721	497031	Bre.	●
50	Dna	00-07	■	18 412 0661	600475	H.T.	●	18 412 0661	600475	H.T.	●
50	Dna	00-07	■	18 412 0601	646829 - 497031	Bre.		18 412 0601	646829 - 497031	Bre.	
50	Dna Gp Experience	03-04	■	18 412 0721	497031	Bre.	●	18 412 0721	497031	Bre.	●



LEVE LEVERS

CC	MODELLO - MODEL	ANNO YEAR	COLORE - COLOUR	SINISTRA - LEFT		IMPIANTO SYSTEM	TERMINALE TERMINAL	DESTRA - RIGHT		IMPIANTO SYSTEM	TERMINALE TERMINAL
				CODICE RMS RMS CODE	RIF. ORIGINALE OEM NUMBER			CODICE RMS RMS CODE	RIF. ORIGINALE OEM NUMBER		
50	Dna Gp Experience	03-04	■	18 412 0661	600475	H.T.	●	18 412 0661	600475	H.T.	●
50	Dna Gp Experience	03-04	■	18 412 0601	646829 - 497031	Bre.		18 412 0601	646829 - 497031	Bre.	
50	Easy Moving	95-96	■	18 410 0111	564689			18 412 0231	494951		
50	Ice	01-05	■	18 410 0851	647552			18 412 0721	497031	Bre.	●
50	Ice	01-05	■					18 412 0601	646829 - 497031	Bre.	
50	Runner	97-00	■	18 412 0111	494952	Gri.		18 412 0111	494952	Gri.	
50	Runner Disco Ant./Tamb. Post	97-00	■					18 412 0111	494952	Gri.	
50	Runner Poggiali	02	■	18 412 0111	494952	Gri.		18 412 0111	494952	Gri.	
50	Runner Poggiali	02	■	18 412 0651	497041	H.T.		18 412 0651	497041	H.T.	
50	Runner Purejet	02-04	■	18 412 0111	494952	Gri.		18 412 0111	494952	Gri.	
50	Runner Purejet	02-04	■	18 412 0651	497041	H.T.		18 412 0651	497041	H.T.	
50	Runner Purejet	05-10	□	18 412 0711	497042	H.T.	●	18 412 0711	497042	H.T.	●
50	Runner Purejet	05-10	□	18 412 0652	646833	H.T.		18 412 0652	646833	H.T.	
50	Runner Purejet St	08	□	18 412 0711	497042	H.T.	●	18 412 0711	497042	H.T.	●
50	Runner Purejet St	08	□	18 412 0652	646833	H.T.		18 412 0652	646833	H.T.	
50	Runner Sp	02-04	■	18 412 0111	494952	Gri.		18 412 0111	494952	Gri.	
50	Runner Sp	05-07	□	18 412 0711	497042	H.T.	●	18 412 0711	497042	H.T.	●
50	Runner Sp	05-07	□	18 412 0652	646833	H.T.		18 412 0652	646833	H.T.	
50	Runner Sp	10	□	18 412 0652	646833	H.T.		18 412 0652	646833	H.T.	
50	Runner Sp	10	□	18 412 0711	497042	H.T.	●	18 412 0711	497042	H.T.	●
50	Runner Sp Spec Edit	07	□	18 412 0652	646833	H.T.		18 412 0711	497042	H.T.	
50	Runner Sp Spec Edit	07	□	18 412 0711	497042	H.T.	●	18 412 0731	646803	Gri.	●
50	Runner Sp Spec Edit	07	□	18 412 0711	497042	H.T.	●	18 412 0711	497042	H.T.	●
50	Runner Sp Spec Edit	07	□	18 412 0652	646833	H.T.		18 412 0652	646833	H.T.	
50	Runner Sp St & Simoncell	08-09	□	18 412 0652	646833	H.T.		18 412 0652	646833	H.T.	
50	Runner Sp St & Simoncell	08-09	□	18 412 0711	497042	H.T.	●	18 412 0711	497042	H.T.	●
50	Stalker	97-00	■	18 412 0111	494952	Gri.		18 412 0111	494952	Gri.	
50	Stalker	97-06	■	18 410 0531	562450			18 412 0111	494952	Gri.	
50	Stalker	97-06	■	18 410 0591	564682		●	18 412 0111	494952	Gri.	
50	Stalker	07-09	■	18 410 0591	564682		●	18 412 0651	497041	H.T.	
50	Stalker	07-09	■	18 410 0531	562450			18 412 0651	497041	H.T.	
50	Stalker Naked	08	■	18 410 0851	647552			18 412 0661	600475	H.T.	●
50	Stalker Spec Edit	07-08	■	18 410 0531	562450			18 412 0651	497041	H.T.	
50	Stalker Spec Edit	07-08	■	18 410 0591	564682		●	18 412 0651	497041	H.T.	
50	Storm	94-95	■	18 410 0111	564689			18 412 0091	564690		
50	Storm Eu2	07	□	18 410 0181	564683			18 412 0652	646833	H.T.	
50	Storm Eu2	07	□	18 410 0181	564683			18 412 0711	497042	H.T.	●
50	Typhoon	94-97	■	18 410 0111	564689			18 412 0091	564690		
50	Typhoon X	98-99	■	18 410 0111	564689			18 412 0091	564690		
50	Typhoon Xr	00	■	18 410 0111	564689			18 412 0091	564690		
125	Dna	01	■	18 412 0721	497031	Bre.	●	18 412 0721	497031	Bre.	●
125	Dna	01	■	18 412 0601	646829 - 497031	Bre.		18 412 0601	646829 - 497031	Bre.	
125	Nexus Eu3	07-08	■	18 412 0661	600475	H.T.	●	18 412 0661	600475	H.T.	●
125	Nexus Eu3 le	08-10	■	18 412 0661	600475	H.T.	●	18 412 0661	600475	H.T.	●
125	Runner Fx-Fxr	97-02	□	18 410 0181	564683			18 412 0652	646833	H.T.	
125	Runner Fx-Fxr	97-02	□	18 412 0711	497042	H.T.	●	18 412 0711	497042	H.T.	●
125	Runner Fx-Fxr	97-02	□	18 410 0601	564683		●	18 412 0711	497042	H.T.	●

● Terminale grosso - Big end lever
 ■ Colore nero - Black
 □ Colore lucido - Glossy

GRI Grimeca
 H.T. Heng Tong
 BRE Brembo

DX Destra - Right
 SX Sinistra - Left

LEVE
LEVERS



CC	MODELLO - MODEL	ANNO YEAR	COLORE - COLOUR	SINISTRA - LEFT		IMPIANTO SYSTEM	TERMINALE TERMINAL	DESTRA - RIGHT		IMPIANTO SYSTEM	TERMINALE TERMINAL
				CODICE RMS RMS CODE	RIF. ORIGINALE OEM NUMBER			CODICE RMS RMS CODE	RIF. ORIGINALE OEM NUMBER		
125	Runner Fx-Fxr	97-02	■	18 412 0651	497041	H.T.		18 412 0651	497041	H.T.	
125	Runner Fx-Fxr	97-02	■	18 412 0111	494952	Gri.		18 412 0111	494952	Gri.	
125	Runner Fx-Fxr	97-02	■					18 412 0111	494952	Gri.	
125	Runner Vx	05-06	□	18 412 0711	497042	H.T.	●	18 412 0711	497042	H.T.	●
125	Runner Vx	05-06	□	18 412 0652	646833	H.T.		18 412 0652	646833	H.T.	
125	Runner Vx	05-06	□	18 412 0731	646803	Gri.	●	18 412 0731	646803	Gri.	●
125	Runner Vx 4T Eu3	07	□	18 412 0711	497042	H.T.	●	18 412 0711	497042	H.T.	●
125	Runner Vx 4T Eu3	07	□	18 412 0652	646833	H.T.		18 412 0652	646833	H.T.	
125	Runner Vx 4T St Eu3	08-09	□	18 412 0711	497042	H.T.	●	18 412 0711	497042	H.T.	●
125	Runner Vx 4T St Eu3	08-09	□	18 412 0652	646833	H.T.		18 412 0652	646833	H.T.	
125	Runner Vx Race	06	□	18 412 0731	646803	Gri.	●	18 412 0731	646803	Gri.	●
125	Runner Vx Race	06	□	18 412 0711	497042	H.T.	●	18 412 0711	497042	H.T.	●
125	Runner Vx Race	06	□	18 412 0652	646833	H.T.		18 412 0652	646833	H.T.	
125	Runner Vx Sc	06-07	□	18 412 0731	646803	Gri.	●	18 412 0711	497042	H.T.	●
125	Runner Vx-Vxr	00-01	□	18 412 0711	497042	H.T.	●	18 412 0711	497042	H.T.	●
125	Runner Vx-Vxr	00-01	□	18 412 0652	646833	H.T.		18 412 0652	646833	H.T.	
125	Runner Vx-Vxr	00-01	■	18 412 0651	497041	H.T.		18 412 0651	497041	H.T.	
125	Typhoon	95-98	■					18 412 0101	271449		
125	Typhoon X-Xr	99-00	■					18 412 0101	271449		
180	Dna	01	■	18 412 0721	497031	Bre.	●	18 412 0721	497031	Bre.	●
180	Dna	01	■	18 412 0601	646829 - 497031	Bre.		18 412 0601	646829 - 497031	Bre.	
180	Runner Fx-Fxr	97-02	□	18 410 0181	564683			18 412 0652	646833	H.T.	
180	Runner Fx-Fxr	97-02	□	18 412 0711	497042	H.T.	●	18 412 0711	497042	H.T.	●
180	Runner Fx-Fxr	97-02	□	18 410 0601	564683		●	18 412 0711	497042	H.T.	●
180	Runner Fx-Fxr	97-02	■	18 412 0651	497041	H.T.		18 412 0651	497041	H.T.	
180	Runner Fx-Fxr	97-02	■	18 412 0111	494952	Gri.		18 412 0111	494952	Gri.	
180	Runner Fx-Fxr	97-02	■					18 412 0111	494952	Gri.	
180	Runner Vx-Vxr	00-04	□	18 412 0711	497042	H.T.	●	18 412 0711	497042	H.T.	●
180	Runner Vx-Vxr	00-04	□	18 412 0652	646833	H.T.		18 412 0652	646833	H.T.	
180	Runner Vx-Vxr	00-04	■	18 412 0111	494952	Gri.		18 412 0111	494952	Gri.	
200	Runner Vxr	05-06	□	18 412 0711	497042	H.T.	●	18 412 0711	497042	H.T.	●
200	Runner Vxr	05-06	□	18 412 0652	646833	H.T.		18 412 0652	646833	H.T.	
200	Runner Vxr	05-06	□	18 412 0731	646803	Gri.	●	18 412 0731	646803	Gri.	●
200	Runner Vxr 4T St Eu3	08	□	18 412 0711	497042	H.T.	●	18 412 0711	497042	H.T.	●
200	Runner Vxr 4T St Eu3	08	□	18 412 0652	646833	H.T.		18 412 0652	646833	H.T.	
200	Runner Vxr Eu3	07	□	18 412 0711	497042	H.T.	●	18 412 0711	497042	H.T.	●
200	Runner Vxr Eu3	07	□	18 412 0652	646833	H.T.		18 412 0652	646833	H.T.	
200	Runner Vxr Eu3	07	□	18 412 0731	646803	Gri.	●	18 412 0731	646803	Gri.	●
200	Runner Vxr Race	06	□	18 412 0711	497042	H.T.	●	18 412 0711	497042	H.T.	●
200	Runner Vxr Race	06	□	18 412 0652	646833	H.T.		18 412 0652	646833	H.T.	
200	Runner Vxr Race	06	□	18 412 0731	646803	Gri.	●	18 412 0731	646803	Gri.	●
250	Beverly Cruiser	07-09	□	18 410 0841	649196	Bre.		18 410 0841	649196	Bre.	
250	Nexus Eu3	06-07	■	18 412 0661	600475	H.T.	●	18 412 0661	600475	H.T.	●
250	Nexus Sp Eu3	06-07	■	18 412 0661	600475	H.T.	●	18 412 0661	600475	H.T.	●
300	Nexus Eu3	08-09	■	18 412 0661	600475	H.T.	●	18 412 0661	600475	H.T.	●
500	Beverly Cruiser	07-12	□	18 410 0841	649196	Bre.		18 410 0841	649196	Bre.	
500	Fuoco Eu3	07-11	■	18 412 0661	600475	H.T.	●	18 412 0601	646829 - 497031	Bre.	



LEVE LEVERS

CC	MODELLO - MODEL	ANNO YEAR	COLORE - COLOUR	SINISTRA - LEFT		IMPIANTO SYSTEM	TERMINALE TERMINAL	DESTRA - RIGHT		IMPIANTO SYSTEM	TERMINALE TERMINAL
				CODICE RMS RMS CODE	RIF. ORIGINALE OEM NUMBER			CODICE RMS RMS CODE	RIF. ORIGINALE OEM NUMBER		
500	Fuoco Eu3	07-11	■	18 412 0661	600475	H.T.	●	18 412 0721	497031	Bre.	●
500	Nexus	03-05	■	18 412 0721	497031	Bre.	●	18 412 0721	497031	Bre.	●
500	Nexus	03-05	■	18 412 0601	646829	Bre.		18 412 0601	646829	Bre.	
500	Nexus Eu3	06-11	■	18 412 0721	497031	Bre.	●	18 412 0721	497031	Bre.	●
500	Nexus Eu3	06-11	■	18 412 0601	646829	Bre.		18 412 0601	646829	Bre.	
500	Nexus Sp Eu3	06-07	■	18 412 0721	497031	Bre.	●	18 412 0721	497031	Bre.	●
500	Nexus Sp Eu3	06-07	■	18 412 0601	646829	Bre.		18 412 0601	646829	Bre.	
HONDA											
50	Sh-fifty-balj-sh - Ft	>95	■	18 410 0341							
50	Sky - Fd		■	18 410 0371				18 412 0421			
50	Sh - Fd	96>	■	18 410 0381				18 412 0431			
50	Sfx		■	18 410 0391				18 412 0431			
50	Vision Pk Wallaro		■	18 410 0391							
50	Balj		■	18 410 0341				18 412 0441			
100	Balj		■	18 410 0341				18 412 0441			
125	Chiocciola - Sh-Dylan		□	18 410 0441				18 412 0541			
150	Chiocciola - Sh-Dylan		□	18 410 0441				18 412 0541			
125	Sh I	09-10	□	18 410 0611				18 412 0741			
150	Sh I	09-10	□	18 410 0611				18 412 0741			
125	Pantheon		■	18 410 0451				18 412 0551			
150	Pantheon		■	18 410 0451				18 412 0551			
250	Foresight		■	18 410 0451				18 412 0551			
300	Sh		□	18 410 0611				18 412 0741			
ITALJET											
50	Pista		■	18 410 0131							
50	Bazooka		■	18 410 0131							
50	Scoop		■	18 410 0131							
KYMCO											
50	Agility 4T R10	06-08	■	18 410 0711	00152580			18 412 0761	00153413		
50	Agility 4T R12	07-08	□	18 410 0481	00152161-00152050			18 412 0581	00153159		
50	Agility 4T R16	08	■	18 410 0721	00153308			18 412 0761	00153413		
50	Agility 4T R16	09	■	18 410 0721	00153308			18 412 0761	00153413		
50	Agility R12	05	□	18 410 0481	00152161-00152050			18 412 0581	00153159		
50	Agility Rs	09	□					18 412 0581	00153159		
50	Agility Rs Naked 2T	10	□					18 412 0581	00153159		
50	B&W	02	□					18 412 0571	00153960		
50	B&W Euro2	03	□					18 412 0571	00153960		
50	Dink 50 4T	07	■					18 412 0461	00156915		
50	Dink Classic Euro2	03	□					18 412 0571	00153960		
50	Dink Lc	99-02	□					18 412 0571	00153960		
50	Dj W	94-00	■	18 410 0131	00152020						
50	Dj X	91-92	■	18 410 0131	00152020						
50	Djy	93	■	18 410 0131	00152020						
50	Fever Zx	99-00	□	18 410 0481	00152161-00152050			18 412 0681	00153760		
50	Fever Zx Euro2	03-04	□	18 410 0481	00152161-00152050			18 412 0681	00153760		
50	Like 2T	09	□					18 412 0681	00153760		
50	Mxer	02-03	■	18 410 0461	00153984						

● Terminale grosso - Big end lever
 ■ Colore nero - Black
 □ Colore lucido - Glossy

GRI Grimeca
 H.T. Heng Tong
 BRE Brembo

DX Destra - Right
 SX Sinistra - Left

LEVE
LEVERS



CC	MODELLO - MODEL	ANNO YEAR	COLORE - COLOUR	SINISTRA - LEFT		IMPIANTO SYSTEM	TERMINALE TERMINAL	DESTRA - RIGHT		IMPIANTO SYSTEM	TERMINALE TERMINAL
				CODICE RMS RMS CODE	RIF. ORIGINALE OEM NUMBER			CODICE RMS RMS CODE	RIF. ORIGINALE OEM NUMBER		
50	Mxer Euro2	04	■	18 410 0461	00153984						
50	Mxu	06-07	■	18 410 0461	00153984						
50	Mxu Sr	06	■	18 410 0461	00153984						
50	People	99-00	□	18 410 0481	00152161-00152050			18 412 0581	00153159		
50	People	04	□	18 410 0481	00152161-00152050			18 412 0581	00153159		
50	People Euro2	03	□	18 410 0481	00152161-00152050			18 412 0581	00153159		
50	People Euro2	08-11	□	18 410 0481	00152161-00152050			18 412 0581	00153159		
50	People S	05-08	□	18 410 0741	00153759			18 412 0681	00153760		
50	People S 4T	06-08	□	18 410 0741	00153759			18 412 0681	00153760		
50	Sento	08	□	18 410 0481	00152161-00152050			18 412 0581	00153159		
50	Super 8	07	□	18 410 0741	00153759			18 412 0581	00153159		
50	Super 8 2T	09	□	18 410 0741	00153759			18 412 0581	00153159		
50	Super 8 4T	09	□	18 410 0741	00153759			18 412 0581	00153159		
50	Super 9	00	□	18 410 0541	00153782			18 412 0681	00153760		
50	Super 9 Sport Euro2	03-04	□	18 410 0541	00153782			18 412 0681	00153760		
50	Top Boy	97-00	■	18 410 0711	00152580			18 412 0761	00153413		
50	Vitality 2T	04	□	18 410 0481	00152161-00152050			18 412 0581	00153159		
50	Vitality 4T	04	□	18 410 0481	00152161-00152050			18 412 0581	00153159		
50	Yup Euro2	03	□	18 410 0481	00152161-00152050			18 412 0581	00153159		
125	Agility 4T	06	□	18 410 0481	00152161-00152050			18 412 0581	00153159		
125	Agility 4T Euro3	06-08	□	18 410 0481	00152161-00152050			18 412 0581	00153159		
125	Agility R16	08-09	■	18 410 0751	00153414			18 412 0761	00153413		
125	Agility Rs	09	□					18 412 0581	00153159		
125	B&W	00	□	18 410 0471	00153977			18 412 0571	00153960		
125	B&W Euro2	03-04	□	18 410 0471	00153977			18 412 0571	00153960		
125	Dink Euro3	06-07	■	18 410 0461	00153984			18 412 0461	00156915		
125	Dink	97-98	■	18 410 0461	00153984			18 412 0461	00156915		
125	Dink Classic	02	□	18 410 0471	00153977			18 412 0571	00153960		
125	Dink Classic Euro2	03	□	18 410 0471	00153977			18 412 0571	00153960		
125	Dink Lx	98-00	□	18 410 0471	00153977			18 412 0571	00153960		
125	Downtown I	09	□	18 410 0761	00153298			18 412 0801	00153297		
125	Grand Dink	01-02	□	18 410 0471	00153977			18 412 0571	00153960		
125	Grand Dink Euro2	03-04	□	18 410 0471	00153977			18 412 0571	00153960		
125	Like	09	□	18 410 0541	00153782			18 412 0681	00153760		
125	Movie	99-00	□	18 410 0481	00152161-00152050			18 412 0681	00153760		
125	Movie 125 Euro3	06-07	□	18 410 0481	00152161-00152050			18 412 0681	00153760		
125	Movie XI	01	□	18 410 0481	00152161-00152050			18 412 0681	00153760		
125	Movie XI Euro2	03-04	□	18 410 0481	00152161-00152050			18 412 0681	00153760		
125	People	99-00	□	18 410 0481	00152161-00152050			18 412 0581	00153159		
125	People Euro2	03	□	18 410 0481	00152161-00152050			18 412 0581	00153159		
125	People Euro3	07-11	□	18 410 0481	00152161-00152050			18 412 0581	00153159		
125	People Gti	10	□	18 410 0471	00153977			18 412 0571	00153960		
125	People S	05	□	18 410 0481	00152161-00152050			18 412 0681	00153760		
125	People S Dd Euro3	07-08	□	18 410 0541	00153782			18 412 0681	00153760		
125	Super 8	08-09	□	18 410 0741	00153759			18 412 0581	00153159		
125	Vivio	00	□	18 410 0481	00152161-00152050			18 412 0681	00153760		
150	Agility R16	08	■	18 410 0751	00153414			18 412 0761	00153413		



LEVE LEVERS

CC	MODELLO - MODEL	ANNO YEAR	COLORE - COLOUR	SINISTRA - LEFT		IMPIANTO SYSTEM	TERMINALE TERMINAL	DESTRA - RIGHT		IMPIANTO SYSTEM	TERMINALE TERMINAL
				CODICE RMS RMS CODE	RIF. ORIGINALE OEM NUMBER			CODICE RMS RMS CODE	RIF. ORIGINALE OEM NUMBER		
150	Agility R16	09	■	18 410 0751	00153414			18 412 0761	00153413		
150	B&W	00	□	18 410 0471	00153977			18 412 0571	00153960		
150	B&W Euro2	03-04	□	18 410 0471	00153977			18 412 0571	00153960		
150	Dink	97-98	■	18 410 0461	00153984			18 412 0461	00156915		
150	Dink Classic - Eu2	02-03	□	18 410 0471	00153977			18 412 0571	00153960		
150	Dink Lx	98-00	□	18 410 0471	00153977			18 412 0571	00153960		
150	Grand Dink	01-02	□	18 410 0471	00153977			18 412 0571	00153960		
150	Grand Dink Euro2	03-04	□	18 410 0471	00153977			18 412 0571	00153960		
150	Movie Euro3	06-07	□	18 410 0481	00152161-00152050			18 412 0681	00153760		
150	People	99-00	□	18 410 0481	00152161-00152050			18 412 0581	00153159		
150	People Euro2	03	□	18 410 0481	00152161-00152050			18 412 0581	00153159		
200	Agility I R16	10	■	18 410 0751	00153414			18 412 0761	00153413		
200	Dink Classic	04	□	18 410 0471	00153977			18 412 0571	00153960		
200	Dink Euro3l	06-07	■	18 410 0461	00153984			18 412 0461	00156915		
200	Downtown I	10	□	18 410 0761	00153298			18 412 0801	00153297		
200	Like 200l	09	□	18 410 0541	00153782			18 412 0681	00153760		
200	People Gti	10	□	18 410 0471	00153977			18 412 0571	00153960		
200	People S	05	□	18 410 0481	00152161-00152050			18 412 0681	00153760		
200	People S 200l	07	□	18 410 0541	00153782			18 412 0681	00153760		
250	B&W	00	□	18 410 0471	00153977			18 412 0571	00153960		
250	B&W Euro2	03	□	18 410 0471	00153977			18 412 0571	00153960		
250	Grand Dink	01-02	□	18 410 0471	00153977			18 412 0571	00153960		
250	Grand Dink Euro2	03-04	□	18 410 0471	00153977			18 412 0571	00153960		
250	People Lc	03-04	□	18 410 0471	00153977			18 412 0571	00153960		
250	People S	06	□	18 410 0471	00153977			18 412 0571	00153960		
250	People S 250l	07	□	18 410 0471	00153977			18 412 0571	00153960		
250	Yup	03	□	18 410 0471	00153977			18 412 0571	00153960		
300	Downtown I	09	□	18 410 0761	00153298			18 412 0801	00153297		
300	Downtown Abs	10	□	18 410 0761	00153298			18 412 0801	00153297		
300	Downtown I Abs	11	□	18 410 0761	00153298			18 412 0801	00153297		
300	Downtown I	11	□	18 410 0761	00153298			18 412 0801	00153297		
300	People Gti	10	□	18 410 0471	00153977			18 412 0571	00153960		
300	People S 300l	08	□	18 410 0471	00153977			18 412 0571	00153960		
300	X Citing I R	08	□	18 410 0761	00153298			18 412 0801	00153297		
300	X Citing I R	09	□	18 410 0761	00153298			18 412 0801	00153297		
300	X Citing I	08	□	18 410 0761	00153298			18 412 0801	00153297		
700	Myroad I	11	□	18 410 0761	00153298			18 412 0801	00153297		
LEM											
50	Flash		■	18 410 0131							
50	Tornado		■	18 410 0131							
MALAGUTI											
50	Centro 4T	08	■	18 410 0651	12120903			18 412 0771	12121003		
50	Centro Base	93-94	■	18 410 0131	12112103						
50	Centro SI	94-95	■	18 410 0131	12112103			18 412 0411	12113203		
50	Centro SI	96-98	■	18 410 0361	12113303			18 412 0411	12113203		
50	Centro SI 4T	10	■	18 410 0651	12120903			18 412 0771	12121003		
50	Centro SI Kat	99-00	■	18 410 0361	12113303			18 412 0411	12113203		

● Terminale grosso - *Big end lever*
 ■ Colore nero - *Black*
 □ Colore lucido - *Glossy*

GRI Grimeca
 H.T. Heng Tong
 BRE Brembo

DX Destra - *Right*
 SX Sinistra - *Left*

LEVE
LEVERS



CC	MODELLO - MODEL	ANNO YEAR	COLORE - COLOUR	SINISTRA - LEFT		IMPIANTO SYSTEM	TERMINALE TERMINAL	DESTRA - RIGHT		IMPIANTO SYSTEM	TERMINALE TERMINAL
				CODICE RMS RMS CODE	RIF. ORIGINALE OEM NUMBER			CODICE RMS RMS CODE	RIF. ORIGINALE OEM NUMBER		
50	Ciak	99-00	■	18 410 0361	12113303			18 412 0411	12113203		
50	Ciak Master	04	■	18 410 0361	12113303			18 412 0411	12113203		
50	Ciak Master 4T	05-06	■	18 410 0361	12113303			18 412 0411	12113203		
50	Ciak Master Euro 2	06	■	18 410 0361	12113303			18 412 0411	12113203		
50	Ciak Mono Euro 2	03	■	18 410 0361	12113303			18 412 0411	12113203		
50	Ciak Mono Euro 2 2.3	03	■	18 410 0361	12113303			18 412 0411	12113203		
50	Ciak Td	00-01	■	18 410 0631	12114203			18 412 0411	12113203		
50	Crosser Cr1	95-98	■	18 410 0361	12113303			18 412 0411	12113203		
50	F10 Ac	08	■	18 410 0361	12113303			18 412 0411	12113203		
50	F10 Ac Eco	09-10	■	18 410 0361	12113303			18 412 0771	12121003		
50	F10 Jet Line	92-93	■	18 410 0131	12112103			18 412 0411	12113203		
50	F10 Jet Line	94-98	■	18 410 0361	12113303			18 412 0411	12113203		
50	F10 Kat	99-00	■	18 410 0361	12113303			18 412 0411	12113203		
50	F10 Rst Eu1	01-02	■	18 410 0361	12113303			18 412 0411	12113203		
50	F10 Rst Eu2-2.3	03-04	■	18 410 0361	12113303			18 412 0411	12113203		
50	F10 Rst Euro 2	02-03	■	18 410 0361	12113303			18 412 0411	12113203		
50	F10 Rst Euro 2	06	■	18 410 0361	12113303			18 412 0411	12113203		
50	F12 Aria Rst Euro 2	06	■	18 410 0361	12113303			18 412 0411	12113203		
50	F12 Lc Rst Euro 2	06	■	18 410 0631	12114203			18 412 0411	12113203		
50	F12 Phantom	94-98	■	18 410 0361	12113303			18 412 0411	12113203		
50	F12 Phantom Euro1	99-00	■	18 410 0361	12113303			18 412 0411	12113203		
50	F12 Phantom Lc	94-98	■	18 410 0361	12113303			18 412 0411	12113203		
50	F12 Phantom Lc Euro1	99-00	■	18 410 0631	12114203			18 412 0411	12113203		
50	F12 Phantom Lc Rst Eu1	01-02	■	18 410 0631	12114203			18 412 0411	12113203		
50	F12 Phantom Lc Rst Eu2	02	■	18 410 0631	12114203			18 412 0411	12113203		
50	F12 Phantom Lc Rst Eu2-2.3	03-04	■	18 410 0631	12114203			18 412 0411	12113203		
50	F12 Phantom Lc Twin Disks	98	■	18 410 0631	12114203			18 412 0411	12113203		
50	F12 Phantom Rst Eu1	01-02	■	18 410 0361	12113303			18 412 0411	12113203		
50	F12 Phantom Rst Eu2	02	■	18 410 0361	12113303			18 412 0411	12113203		
50	F12 Phantom Rst Eu2-2.3	03-04	■	18 410 0361	12113303			18 412 0411	12113203		
50	F12R Phantom Ac	07-08	■	18 410 0671	12120703			18 412 0411	12113203		
50	F12R Phantom Ac	09-10	■	18 410 0651	12120903			18 412 0771	12121003		
50	F12R Phantom Lc	07-10	■	18 410 0631	12114203			18 412 0411	12113203		
50	F12R Phantom Lc (Da Manubrio ZJM5883)	07-10	■	18 410 0641	12121103			18 412 0771	12121003		
50	F15 Fire Fox	96-98	■	18 410 0631	12114203			18 412 0411	12113203		
50	F15 Fire Fox Air Cooled	05-06	■	18 410 0361	12113303			18 412 0411	12113203		
50	F15 Fire Fox Euro2	02-03	■	18 410 0631	12114203			18 412 0411	12113203		
50	F15 Fire Fox Rst Euro2-2.3	03-04	■	18 410 0631	12114203			18 412 0411	12113203		
50	F15 Fire Fox Twin Disks & Spec.	98-99	■	18 410 0631	12114203			18 412 0411	12113203		
50	F15 Fire Fox Twin Disks Kat	98-00	■	18 410 0631	12114203			18 412 0411	12113203		
50	F15 Lc Rst Euro 2	04-05	■	18 410 0631	12114203			18 412 0411	12113203		
50	F15 Lc-Tds Rst Euro 1	01	■	18 410 0631	12114203			18 412 0411	12113203		
50	Yesterday - Yesterday Euro	97-00	■	18 410 0361	12113303			18 412 0411	12113203		
100	Ciak	99-00	■	18 410 0631	12114203			18 412 0411	12113203		
100	F12 Phantom	99-00	■	18 410 0631	12114203			18 412 0411	12113203		
125	Blog	09-10	■	18 410 0661	12119803			18 412 0781	12119703		
125	Blog	11	■	18 410 0641	12121103			18 412 0771	12121003		



LEVE LEVERS

CC	MODELLO - MODEL	ANNO YEAR	COLORE - COLOUR	SINISTRA - LEFT		IMPIANTO SYSTEM	TERMINALE TERMINAL	DESTRA - RIGHT		IMPIANTO SYSTEM	TERMINALE TERMINAL
				CODICE RMS RMS CODE	RIF. ORIGINALE OEM NUMBER			CODICE RMS RMS CODE	RIF. ORIGINALE OEM NUMBER		
125	Centro le	08-09	■	18 410 0661	12119803			18 412 0781	12119703		
125	Centro SI	11	■	18 410 0641	12121103			18 412 0771	12121003		
125	Centro SI	09-10	■	18 410 0661	12119803			18 412 0781	12119703		
125	Ciak	00-01	■	18 410 0361	12113303			18 412 0411	12113203		
125	Ciak Master	04	■	18 410 0361	12113303			18 412 0411	12113203		
125	Ciak Master Euro 3	06	■	18 410 0361	12113303			18 412 0411	12113203		
125	Ciak Rst Euro2	03	■	18 410 0361	12113303			18 412 0411	12113203		
125	F18 Warrior	00-02	■	18 410 0631	12114203			18 412 0411	12113203		
125	Madison	99-01	■	18 412 0591	12114303			18 412 0591	12114303		
125	Madison 3	06-09	■	18 412 0591	12114303			18 412 0591	12114303		
125	Madison R Rst	02	■	18 412 0591	12114303			18 412 0591	12114303		
125	Madison R Rst Euro2	03-04	■	18 412 0591	12114303			18 412 0591	12114303		
125	Phantom Max	03	■	18 412 0591	12114303			18 412 0591	12114303		
150	Ciak	00-02	■	18 410 0361	12113303			18 412 0411	12113203		
150	Ciak Master	04	■	18 410 0361	12113303			18 412 0411	12113203		
150	Ciak Rst Euro2	03	■	18 410 0361	12113303			18 412 0411	12113203		
150	F18 Warrior	00-02	■	18 410 0631	12114203			18 412 0411	12113203		
150	Madison T	99-01	■	18 412 0591	12114303			18 412 0591	12114303		
160	Blog le	11	■	18 410 0641	12121103			18 412 0771	12121003		
160	Blog	09-10	■	18 410 0661	12119803			18 412 0781	12119703		
160	Centro le	08-09	■	18 410 0661	12119803			18 412 0781	12119703		
160	Centro SI	11	■	18 410 0641	12121103			18 412 0771	12121003		
160	Centro SI	09-10	■	18 412 0591	12114303			18 412 0781	12119703		
180	Madison R	01-02	■	18 412 0591	12114303			18 412 0591	12114303		
200	Ciak Master Euro 2	06	■	18 410 0361	12113303			18 412 0411	12113203		
200	Madison S Rst	02	■	18 412 0591	12114303			18 412 0591	12114303		
200	Madison S Rst Euro2	03	■	18 412 0591	12114303			18 412 0591	12114303		
200	Phantom Max	03	■	18 412 0591	12114303			18 412 0591	12114303		
250	Madison 3	06-09	■	18 412 0591	12114303			18 412 0591	12114303		
250	Madison Rs Rst	04	■	18 412 0591	12114303			18 412 0591	12114303		
250	Madison S	99-01	■	18 412 0591	12114303			18 412 0591	12114303		
250	Password	05-06	■	18 412 0591	12114303			18 412 0591	12114303		
250	Password Eu3	07-08	■	18 412 0591	12114303			18 412 0591	12114303		
250	Phantom Max	04	■	18 412 0591	12114303			18 412 0591	12114303		
400	Madison K	02	■	18 412 0591	12114303			18 412 0591	12114303		
400	Madison K Rst	02-04	■	18 412 0591	12114303			18 412 0591	12114303		
500	Spidermax Gt	04-05	■	18 412 0591	12114303			18 412 0591	12114303		
500	Spidermax Gt Euro3	06	■	18 412 0591	12114303			18 412 0591	12114303		
500	Spidermax Rs	08	■	18 412 0591	12114303			18 412 0591	12114303		
MBK											
50	Booster	01-03	■	18 410 0401	5JH-H3912-00			18 412 0821	5NTH39220000		
50	Booster	90-94	■	18 410 0010	3VLH39120100			18 412 0010	3VLH39221000		
50	Booster L	01-03	■	18 410 0401	5JH-H3912-00			18 412 0821	5NTH39220000		
50	Booster Naked	03	■	18 410 0401	5JH-H3912-00			18 412 0821	5NTH39220000		
50	Booster Ng	95-98	□	18 410 0161	4SB-H3912-00			18 412 0171	4SB-H3922-00		
50	Booster Ng	99	■	18 410 0421	4SB-H3912-10			18 412 0511	4SB-H3922-10		
50	Booster Ng	01-03	■	18 410 0401	5JH-H3912-00			18 412 0481	5JH-H3922-00		

● Terminale grosso - Big end lever
 ■ Colore nero - Black
 □ Colore lucido - Glossy

GRI Grimeca
 H.T. Heng Tong
 BRE Brembo

DX Destra - Right
 SX Sinistra - Left

LEVE
LEVERS



CC	MODELLO - MODEL	ANNO YEAR	COLORE - COLOUR	SINISTRA - LEFT		IMPIANTO SYSTEM	TERMINALE TERMINAL	DESTRA - RIGHT		IMPIANTO SYSTEM	TERMINALE TERMINAL
				CODICE RMS RMS CODE	RIF. ORIGINALE OEM NUMBER			CODICE RMS RMS CODE	RIF. ORIGINALE OEM NUMBER		
50	Booster Ng Eu2	01-06	■	18 410 0401	5JH-H3912-00			18 412 0481	5JH-H3922-00		
50	Booster R Road	94-95	■	18 410 0151	4KH-H3912-00			18 412 0151	2NA-83922-01		
50	Booster Rocket	97-98	□	18 410 0161	4SB-H3912-00			18 412 0181	4TD-H3922-00		
50	Booster Spirit	96-98	■	18 410 0151	4KH-H3912-00			18 412 0161	4VV-H3922-00		
50	Booster Spirit	99-00	■	18 410 0421	4SB-H3912-10			18 412 0471	4VV-H3922-10		
50	Booster Spirit Special		□	18 410 0161	4SB-H3912-00			18 412 0151	2NA-83922-01		
50	Booster Spirit Eu2-Sp	02-03	■	18 410 0401	5JH-H3912-00			18 412 0821	5NTH39220000		
50	Booster Spirit L	03	■	18 410 0401	5JH-H3912-00			18 412 0821	5NTH39220000		
50	Booster Track	96-98	□	18 410 0161	4SB-H3912-00			18 412 0171	4SB-H3922-00		
50	Ct S/Ss Sorriso	91-95	■	18 410 0131	1NT-H3912-00						
50	Ct Ss New Sorriso	95-96	■	18 410 0131	1NT-H3912-00						
50	Evolis	92-96	■	18 410 0010	3VLH39120100			18 412 0151	2NA-83922-01		
50	Evolis	95	■	18 410 0151	4KH-H3912-00			18 412 0151	2NA-83922-01		
50	Fizz	94-95	■	18 410 0151	4KH-H3912-00			18 412 0151	2NA-83922-01		
50	Flipper Cat	69-00	□	18 410 0411	5EU-H3912-00			18 412 0491	5EU-H3922-00		
50	Flipper	98-02	□	18 410 0411	5EU-H3912-00			18 412 0491	5EU-H3922-00		
50	Flipper Eu2	01-04	□	18 410 0411	5EU-H3912-00			18 412 0491	5EU-H3922-00		
50	Forte	94-95	■	18 410 0151	4KH-H3912-00			18 412 0151	2NA-83922-01		
50	Mach G Eu1-Eu2	02-04	■	18 410 0401	5JH-H3912-00			18 412 0891	5RWH392200		
50	Nitro Tutti - Jaguar Eu2	97-04		18 412 0391	5BRH39120100			18 412 0391	5BRH39120100		
50	Ovetto Eu1-Eu2 - Tutti	97-04	□	18 410 0141	5AD-H3912-02			18 412 0401	5AD-H3922-01		
50	Stunt	00-02	■	18 410 0401	5JH-H3912-00			18 412 0481	5JH-H3922-00		
50	Target	91-95	■	18 410 0131	1NT-H3912-00			18 412 0151	2NA-83922-01		
100	Ovetto	00-02	□	18 410 0141	5AD-H3912-02			18 412 0401	5AD-H3922-01		
125	Doodo	00-02	■	18 410 0491	5DS-H3912-01			18 412 0601	5DS-H3922-01		
125	Skyliner	98-02	■	18 410 0491	5DS-H3912-01			18 412 0601	5DS-H3922-01		
125	Skyline E	01-03	■	18 412 0601	5DS-H3922-01			18 412 0601	5DS-H3922-01		
125	Thunder	01-02	■	18 412 0601	5DS-H3922-01			18 412 0601	5DS-H3922-01		
125	Xc K Flame R	97-98	■					18 412 0151	2NA-83922-01		
150	Doodo	01-02	■	18 410 0491	5DS-H3912-01			18 412 0601	5DS-H3922-01		
150	Skyliner	00	■	18 410 0491	5DS-H3912-01			18 412 0601	5DS-H3922-01		
150	Skyliner	01-02	■	18 412 0601	5DS-H3922-01			18 412 0601	5DS-H3922-01		
150	Thunder	01-02	■	18 412 0601	5DS-H3922-01			18 412 0601	5DS-H3922-01		
150	Vertex	97	■					18 412 0151	2NA-83922-01		
180	Skyliner E	03-08	■	18 412 0601	5DS-H3922-01			18 412 0601	5DS-H3922-01		
250	Skyliner Abs	00-03	■	18 410 0501	5CG-83912-11			18 412 0611	5CG-83922-01		
300	Kilibre	03-06	■	18 412 0601	5DS-H3922-01			18 412 0601	5DS-H3922-01		
PEUGEOT											
50	Elyseo	99	■					18 412 0671	752868		AJP
50	Elyseo	99	■					18 412 0701	752864		H.T.
50	Jet Force	03	■	18 412 0671	752868		AJP	18 412 0671	752868		AJP
50	Jet Force	03	□	18 412 0691	757025-754709			18 412 0691	757025-754709		
50	Looxor	01-03	■	18 410 0021	754174			18 412 0671	752868		AJP
50	Looxor Tsdì	02	■	18 410 0021	754174			18 412 0671	752868		AJP
50	Ludix 10 Sp Blaster	05-06	■					18 412 0671	752868		AJP
50	Ludix 10 Trend - Snake	04	■	18 410 0021	754174			18 412 0671	752868		AJP
50	Ludix 14 Elegant	04	■	18 410 0021	754174			18 412 0671	752868		AJP



LEVE LEVERS

CC	MODELLO - MODEL	ANNO YEAR	COLORE - COLOUR	SINISTRA - LEFT		IMPIANTO SYSTEM	TERMINALE TERMINAL	DESTRA - RIGHT		IMPIANTO SYSTEM	TERMINALE TERMINAL
				CODICE RMS RMS CODE	RIF. ORIGINALE OEM NUMBER			CODICE RMS RMS CODE	RIF. ORIGINALE OEM NUMBER		
50	Metal-X	02	□					18 412 0691	757025-754709		
50	Speedake	95-97	■	18 410 0021	754174						
50	Speedfight 2 Aria	05-06	■	18 410 0021	754174			18 412 0671	752868	AJP	
50	Speedfight 2 Aria	05-06	■	18 410 0021	754174			18 412 0701	752864	H.T.	
50	Speedfight 2 Lc-Silversport	05-06	□	18 412 0691	757025-754709			18 412 0691	757025-754709		
50	Speedfight Acqua	97-98	■	18 410 0021	754174			18 412 0671	752868	AJP	
50	Speedfight Acqua	97-98	■	18 410 0021	754174			18 412 0701	752864	H.T.	
50	Speedfight Acqua ICD-ICDP	97-98	■	18 412 0671	752868	AJP		18 412 0671	752868	AJP	
50	Speedfight Acqua ICD-ICDP	97-98	■	18 412 0701	752864	H.T.		18 412 0701	752864	H.T.	
50	Speedfight Acqua ICD-ICDP	97-98	□	18 412 0691	757025-754709			18 412 0691	757025-754709		
50	Speedfight Aria	97-98	■	18 410 0021	754174			18 412 0671	752868	AJP	
50	Speedfight Aria	97-98	■	18 410 0021	754174			18 412 0701	752864	H.T.	
50	Speedfight Aria Catalitico	99	■	18 410 0021	754174			18 412 0671	752868	AJP	
50	Speedfight Aria Catalitico	99	■	18 410 0021	754174			18 412 0701	752864	H.T.	
50	Sv Geo Freno Tamb.-Drum	95-97	■	18 410 0021	754174						
50	Sv Geo Freno disco/Disc Grim.	91-95	■	18 410 0021	754174						
50	Squab	95-97	■	18 410 0021	754174			18 412 0671	752868	AJP	
50	Squab	95-97	■	18 410 0021	754174			18 412 0701	752864	H.T.	
50	Trekker	98-00	■	18 410 0021	754174			18 412 0671	752868	AJP	
50	Trekker	98-00	■	18 410 0021	754174			18 412 0701	752864	H.T.	
50	Trk2 Wrc	04-06	□					18 412 0691	757025-754709		
50	Vivacity	99	■	18 410 0021	754174			18 412 0671	752868	AJP	
50	Vivacity	99	■	18 410 0021	754174			18 412 0701	752864	H.T.	
50	Vivacity Catalitico	99-02	■	18 410 0021	754174			18 412 0671	752868	AJP	
50	Vivacity Catalitico	99-02	■	18 410 0021	754174			18 412 0701	752864	H.T.	
50	Vivacity Vsx-Xr	02-04	■					18 412 0671	752868	AJP	
50	Vivacity X-Race		■					18 412 0701	752864	H.T.	
50	Vivacity X-Race		■					18 412 0671	752868	AJP	
50	X-Fight Lc	00	■	18 412 0671	752868	AJP		18 412 0671	752868	AJP	
50	X-Fight Lc	00	■	18 412 0701	752864	H.T.		18 412 0701	752864	H.T.	
50	X-Fight Lc	00	□	18 412 0691	757025-754709			18 412 0691	757025-754709		
50	X-Fight Ac	00	■	18 410 0021	754174			18 412 0671	752868	AJP	
50	X-Fight Ac	00	■	18 410 0021	754174			18 412 0701	752864	H.T.	
50	Xrace	03	□	18 412 0691	757025-754709			18 412 0691	757025-754709		
50	Zenith L	94-96	■	18 410 0021	754174			18 412 0671	752868	AJP	
50	Zenith L	94-96	■	18 410 0021	754174			18 412 0701	752864	H.T.	
50	Zenith Ln-Ls	97-98	■	18 410 0021	754174			18 412 0671	752868	AJP	
50	Zenith Ln-Ls	97-98	■	18 410 0021	754174			18 412 0701	752864	H.T.	
50	Zenith FD Grimeca	97-98	■	18 410 0021	754174						
100	Elyseo	99-01	■	18 410 0021	754174			18 412 0671	752868	AJP	
100	Elyseo	99-01	■	18 410 0021	754174			18 412 0701	752864	H.T.	
100	Looxor	01	□	18 412 0691	757025-754709			18 412 0691	757025-754709		
100	Speedfight	97-00	■	18 412 0671	752868	AJP		18 412 0671	752868	AJP	
100	Speedfight	97-00	□	18 412 0691	757025-754709			18 412 0691	757025-754709		
100	Sv L	98	■					18 412 0701	752864	H.T.	
100	Trekker	98	■	18 410 0021	754174			18 412 0671	752868	AJP	
100	Trekker	98	■	18 410 0021	754174			18 412 0701	752864	H.T.	

● Terminale grosso - Big end lever
 ■ Colore nero - Black
 □ Colore lucido - Glossy

GRI Grimeca
 H.T. Heng Tong
 BRE Brembo

DX Destra - Right
 SX Sinistra - Left

LEVE
LEVERS



CC	MODELLO - MODEL	ANNO YEAR	COLORE - COLOUR	SINISTRA - LEFT		IMPIANTO SYSTEM	TERMINALE TERMINAL	DESTRA - RIGHT		IMPIANTO SYSTEM	TERMINALE TERMINAL
				CODICE RMS RMS CODE	RIF. ORIGINALE OEM NUMBER			CODICE RMS RMS CODE	RIF. ORIGINALE OEM NUMBER		
100	Vivacity	99-01	■	18 410 0021	754174			18 412 0671	752868	AJP	
100	Vivacity	99-01	■	18 410 0021	754174			18 412 0701	752864	H.T.	
100	X-Fight	00-01	■	18 412 0671	752868	AJP		18 412 0671	752868	AJP	
100	X-Fight	00-01	■	18 412 0701	752864	H.T.		18 412 0701	752864	H.T.	
100	X-Fight	00-01	□	18 412 0691	757025-754709			18 412 0691	757025-754709		
125	Sv Tamburo - Drum	91-95	■	18 410 0021	754174						
125	Elyseo	99-00	■	18 410 0021	754174			18 412 0671	752868	AJP	
125	Elyseo	99-00	■	18 410 0021	754174			18 412 0701	752864	H.T.	
125	Elyseo	01	■	18 410 0021	754174			18 412 0671	752868	AJP	
150	Elyseo	99-00	■	18 410 0021	754174			18 412 0671	752868	AJP	
150	Elyseo	99-00	■	18 410 0021	754174			18 412 0701	752864	H.T.	
PGO											
50	Big Max	96	■	18 410 0131				18 412 0151			
PIAGGIO											
50	Ciao Sc	-	□	18 410 1060	156378			18 410 1060	156378		
50	Ciao Px	-	■	18 410 1100	176945			18 412 1070	177340		
50	Fly 2T	05-07	□	18 410 0181	561131			18 412 0731	646803	Gri.	●
50	Fly 2T	05-07	□	18 410 0601	564683		●	18 412 0731	646803	Gri.	●
50	Fly 2T	10	□	18 410 0181	561131			18 412 0731	646803	Gri.	●
50	Fly 2T	10	□	18 410 0601	564683		●	18 412 0731	646803	Gri.	●
50	Fly 2T	10	□	18 410 0181	561131			18 412 0652	646833	H.T.	
50	Fly 2T	10	□	18 410 0601	564683		●	18 412 0711	497042	H.T.	●
50	Fly 4T	05-07	□	18 410 0181	561131			18 412 0731	646803	Gri.	●
50	Fly 4T	05-07	□	18 410 0601	564683		●	18 412 0731	646803	Gri.	●
50	Fly 4T	05-07	□	18 410 0181	561131			18 412 0652	646833	H.T.	
50	Fly 4T	05-07	□	18 410 0601	564683		●	18 412 0711	497042	H.T.	●
50	Fly 4T	08-10	□	18 410 0181	561131			18 412 0731	646803	Gri.	●
50	Fly 4T	08-10	□	18 410 0601	564683		●	18 412 0711	497042	H.T.	●
50	Fly 4T Mot Chn	06-07	□	18 410 0181	561131			18 412 0731	646803	Gri.	●
50	Fly 4T Mot Chn	06-07	□	18 410 0601	564683		●	18 412 0731	646803	Gri.	●
50	Fly 4T Mot Chn	06-07	□	18 410 0601	564683		●	18 412 0652	646833	H.T.	
50	Fly 4T Mot Chn	06-07	□	18 410 0601	564683		●	18 412 0711	497042	H.T.	●
50	Free	92-94	■	18 410 0170	269070						
50	Free Delivery	00-01	■	18 410 0111	564689			18 412 0091	564690		
50	Free Fl	95-02	■	18 410 0111	564689			18 412 0091	564690		
50	Liberty	97-05	□	18 410 0201	564642			18 412 0261	494948	Gri.	
50	Liberty	97-05	□	18 410 0201	564642			18 412 0641	497039	H.T.	
50	Liberty 2T	06-08	□	18 410 0181	561131			18 412 0731	646803	Gri.	●
50	Liberty 2T	06-08	□	18 410 0601	564683		●	18 412 0731	646803	Gri.	●
50	Liberty 2T	06-08	□	18 410 0601	564683		●	18 412 0652	646833	H.T.	
50	Liberty 2T	06-08	□	18 410 0601	564683		●	18 412 0711	497042	H.T.	●
50	Liberty 2T Rst	04	□	18 410 0181	561131			18 412 0731	646803	Gri.	●
50	Liberty 2T Rst	04	□	18 410 0601	564683		●	18 412 0731	646803	Gri.	●
50	Liberty 2T Sport	06-08	□	18 410 0181	561131			18 412 0731	646803	Gri.	●
50	Liberty 2T Sport	06-08	□	18 410 0601	564683		●	18 412 0731	646803	Gri.	●
50	Liberty 2T Sport	06-08	□	18 410 0181	561131			18 412 0652	646833	H.T.	
50	Liberty 2T Sport	06-08	□	18 410 0601	564683		●	18 412 0711	497042	H.T.	●



LEVE
LEVERS

CC	MODELLO - MODEL	ANNO YEAR	COLORE - COLOUR	SINISTRA - LEFT		IMPIANTO SYSTEM	TERMINALE TERMINAL	DESTRA - RIGHT		IMPIANTO SYSTEM	TERMINALE TERMINAL
				CODICE RMS RMS CODE	RIF. ORIGINALE OEM NUMBER			CODICE RMS RMS CODE	RIF. ORIGINALE OEM NUMBER		
50	Liberty 4T	00-02	□	18 410 0201	564642			18 412 0261	494948	Gri.	
50	Liberty 4T	00-02	□	18 410 0201	564642			18 412 0641	497039	H.T.	
50	Liberty 4T	05-08	□	18 410 0181	561131			18 412 0731	646803	Gri.	●
50	Liberty 4T	05-08	□	18 410 0601	564683		●	18 412 0731	646803	Gri.	●
50	Liberty 4T	05-08	□	18 410 0181	561131			18 412 0652	646833	H.T.	
50	Liberty 4T	05-08	□	18 410 0601	564683		●	18 412 0711	497042	H.T.	●
50	Liberty 4T Ptt	09-10	□	18 410 0731	648083			18 412 0711	497042	H.T.	●
50	Liberty 4T Delivery Tnt	09	□	18 410 0731	648083			18 412 0711	497042	H.T.	●
50	Liberty 4T Rst	04	□	18 410 0181	561131			18 412 0731	646803	Gri.	●
50	Liberty 4T Rst	04	□	18 410 0601	564683		●	18 412 0731	646803	Gri.	●
50	Liberty 4T Sport	06-08	□	18 410 0181	561131			18 412 0731	646803	Gri.	●
50	Liberty 4T Sport	06-08	□	18 410 0601	564683		●	18 412 0731	646803	Gri.	●
50	Liberty 4T Sport	07-08	□	18 410 0181	561131			18 412 0652	646833	H.T.	
50	Liberty 4T Sport	07-08	□	18 410 0601	564683		●	18 412 0711	497042	H.T.	●
50	Liberty Moc 2T	09	□	18 410 0601	564683		●	18 412 0711	497042	H.T.	●
50	Liberty Moc 2T	09-10	□	18 410 0181	561131			18 412 0652	646833	H.T.	
50	Liberty Moc 2T	09-10	□	18 410 0601	564683		●	18 412 0731	646803	Gri.	●
50	Liberty Moc 2T	09-10	□	18 410 0181	561131			18 412 0731	646803	Gri.	●
50	Liberty Moc 4T & Elle	09-10	□	18 410 0181	561131			18 412 0652	646833	H.T.	
50	Liberty Moc 4T & Elle	09-10	□	18 410 0601	564683		●	18 412 0711	497042	H.T.	●
50	Liberty Moc 4T & Elle	09-10	□	18 410 0181	561131			18 412 0731	646803	Gri.	●
50	Liberty Moc 4T & Elle	09-10	□	18 410 0601	564683		●	18 412 0731	646803	Gri.	●
50	Liberty Ptt Eu2	04-05	□	18 410 0201	564642			18 412 0641	497039	H.T.	
50	Nrg	94-96	■	18 410 0111	564689			18 412 0091	564690		
50	Nrg Extreme	99-00	■	18 410 0531	562450			18 412 0111	494952	Gri.	
50	Nrg Extreme	01-04	■	18 412 0111	494952	Gri.		18 412 0111	494952	Gri.	
50	Nrg Mc3	01-04	■	18 410 0531	562450			18 412 0111	494952	Gri.	
50	Nrg Mc3	01-04	■	18 412 0651	497041	H.T.		18 412 0651	497041	H.T.	
50	Nrg Power Dd	05-06	□	18 412 0711	497042	H.T.	●	18 412 0711	497042	H.T.	●
50	Nrg Power Dd	07-10	□	18 412 0711	497042	H.T.	●	18 412 0711	497042	H.T.	●
50	Nrg Power Dd	07-10	□	18 412 0652	646833	H.T.		18 412 0652	646833	H.T.	
50	Nrg Power Dd Serie Spec	07-10	□	18 412 0711	497042	H.T.	●	18 412 0731	646803	Gri.	●
50	Nrg Power Dd Serie Spec	07-10	□	18 412 0711	497042	H.T.	●	18 412 0711	497042	H.T.	●
50	Nrg Power Dt	06-08	□	18 410 0181	561131			18 412 0731	646803	Gri.	●
50	Nrg Power Dt	06-08	□	18 410 0601	564683		●	18 412 0731	646803	Gri.	●
50	Nrg Power Dt	06-11	□	18 410 0181	561131			18 412 0652	646833	H.T.	
50	Nrg Power Dt	06-11	□	18 410 0601	564683		●	18 412 0711	497042	H.T.	●
50	Nrg Power Dt Serie Spec	07-08	□	18 410 0181	561131			18 412 0731	646803	Gri.	●
50	Nrg Power Dt Serie Spec	07-08	□	18 410 0601	564683		●	18 412 0731	646803	Gri.	●
50	Nrg Power Dt Serie Spec	07-08	□	18 410 0181	561131			18 412 0652	646833	H.T.	
50	Nrg Power Dt Serie Spec	07-08	□	18 410 0601	564683		●	18 412 0711	497042	H.T.	●
50	Nrg Power Purejet	04-05	■	18 412 0651	497041	H.T.		18 412 0651	497041	H.T.	
50	Nrg Power Purejet	06-08	□	18 412 0711	497042	H.T.	●	18 412 0711	497042	H.T.	●
50	Nrg Power Purejet	07-11	□	18 412 0652	646833	H.T.		18 412 0652	646833	H.T.	
50	Nrg Purejet	02-04	■	18 412 0651	497041	H.T.		18 412 0651	497041	H.T.	
50	Nrg Purejet	02-04	■	18 412 0111	494952	Gri.		18 412 0111	494952	Gri.	
50	Nrg Purejet	10	□	18 412 0711	497042	H.T.	●	18 412 0711	497042	H.T.	●

● Terminale grosso - Big end lever
 ■ Colore nero - Black
 □ Colore lucido - Glossy

GRI Grimeca
 H.T. Heng Tong
 BRE Brembo

DX Destra - Right
 SX Sinistra - Left

LEVE
LEVERS



CC	MODELLO - MODEL	ANNO YEAR	COLORE - COLOUR	SINISTRA - LEFT		IMPIANTO SYSTEM	TERMINALE TERMINAL	DESTRA - RIGHT		IMPIANTO SYSTEM	TERMINALE TERMINAL
				CODICE RMS RMS CODE	RIF. ORIGINALE OEM NUMBER			CODICE RMS RMS CODE	RIF. ORIGINALE OEM NUMBER		
50	Nrg Purejet	10	□	18 412 0652	646833	H.T.		18 412 0652	646833	H.T.	
50	Nrg Rst Mc2	96-98	■					18 412 0101	271449		
50	Nrg Rst Mc2	96-98	■	18 412 0111	494952	Gri.		18 412 0111	494952	Gri.	
50	Ntt	95-96	■	18 410 0111	564689			18 412 0091	564690		
50	Quartz	92-96	■	18 410 0111	564689			18 412 0231	494951		
50	Si	90-91	■	18 410 0310	228967			18 412 1080	228966		
50	Si FL 2	-	■	18 410 0300	268015			18 412 0330	268014		
50	Typhoon	01-04	■	18 410 0111	564689			18 412 0091	564690		
50	Typhoon	05-08	□	18 410 0601	564683		●	18 412 0711	497042	H.T.	●
50	Typhoon	09	□	18 410 0601	564683		●	18 412 0711	497042	H.T.	●
50	Typhoon 2T Eu2	10-12	■	18 410 0861	564681			18 412 0651	497041	H.T.	
50	Typhoon 2T Eu3 Ch	11	■	18 410 0861	564681			18 412 0651	497041	H.T.	
50	Vespa Et2	97-05	□	18 410 0201	564642			18 412 0261	494948	Gri.	
50	Vespa Et2	97-05	□	18 410 0201	564642			18 412 0641	497039	H.T.	
50	Vespa Et2 Iniezione	97-00	□	18 410 0201	564642			18 412 0261	494948	Gri.	
50	Vespa Et4	00-05	□	18 410 0201	564642			18 412 0261	494948	Gri.	
50	Vespa Et4	00-05	□	18 410 0201	564642			18 412 0641	497039	H.T.	
50	Vespa FL2 Automatica	90-91	■					18 412 0280	265947		
50	Vespa FL2 Hp	91-97	■					18 412 0280	265947		
50	Vespa Lx 2T	05-08	□	18 410 0181	561131			18 412 0731	646803	Gri.	●
50	Vespa Lx 2T	05-08	□	18 410 0601	564683		●	18 412 0731	646803	Gri.	●
50	Vespa Lx 2T	05-08	□	18 410 0181	561131			18 412 0652	646833	H.T.	
50	Vespa Lx 2T	05-08	□	18 410 0601	564683		●	18 412 0711	497042	H.T.	●
50	Vespa Lx 2T FL	09-10	□	18 410 0181	561131			18 412 0652	646833	H.T.	
50	Vespa Lx 2T FL	09-10	□	18 410 0601	564683		●	18 412 0711	497042	H.T.	●
50	Vespa Lx 2T Touring	10-13	□	18 410 0181	561131			18 412 0652	646833	H.T.	
50	Vespa Lx 2T Touring	10-13	□	18 410 0601	564683		●	18 412 0711	497042	H.T.	●
50	Vespa Lxv 2T	06-09	□	18 410 0821	648115						
50	Vespa Lx 4T	05-08	□	18 410 0181	561131			18 412 0731	646803	Gri.	●
50	Vespa Lx 4T	05-08	□	18 410 0601	564683		●	18 412 0731	646803	Gri.	●
50	Vespa Lx 4T	05-08	□	18 410 0181	561131			18 412 0652	646833	H.T.	
50	Vespa Lx 4T	05-08	□	18 410 0601	564683		●	18 412 0711	497042	H.T.	●
50	Vespa Lx 4T-4V	09-13	□	18 410 0181	561131			18 412 0652	646833	H.T.	
50	Vespa Lx 4T-4V	09-13	□	18 410 0601	564683		●	18 412 0711	497042	H.T.	●
50	Vespa Lx 4T-4V Touring	10-13	□	18 410 0181	561131			18 412 0652	646833	H.T.	
50	Vespa Lx 4T-4V Touring	10-13	□	18 410 0601	564683		●	18 412 0711	497042	H.T.	●
50	Vespa Primavera 2T	13-14	□	18 410 0601	564683		●	18 412 0711	497042	H.T.	●
50	Vespa Primavera 4T-4V	13-14	□	18 410 0601	564683		●	18 412 0711	497042	H.T.	●
50	Vespa S 2T & College	07-12	□	18 410 0181	561131			18 412 0731	646803	Gri.	●
50	Vespa S 2T & College	07-12	□	18 410 0601	564683		●	18 412 0731	646803	Gri.	●
50	Vespa S 2T & College	07-12	□	18 410 0181	561131			18 412 0652	646833	H.T.	
50	Vespa S 2T & College	07-12	□	18 410 0601	564683		●	18 412 0711	497042	H.T.	●
50	Vespa S 4T-4V & College	08-12	□	18 410 0181	561131			18 412 0731	646803	Gri.	●
50	Vespa S 4T-4V & College	08-12	□	18 410 0601	564683		●	18 412 0731	646803	Gri.	●
50	Vespa S 4T-4V & College	08-12	□	18 410 0181	561131			18 412 0652	646833	H.T.	
50	Vespa S 4T-4V & College	08-12	□	18 410 0601	564683		●	18 412 0711	497042	H.T.	●
50	Vespa Pk FL	90	□	18 410 0261	274546						



LEVE LEVERS

CC	MODELLO - MODEL	ANNO YEAR	COLORE - COLOUR	SINISTRA - LEFT		IMPIANTO SYSTEM	TERMINALE TERMINAL	DESTRA - RIGHT		IMPIANTO SYSTEM	TERMINALE TERMINAL
				CODICE RMS RMS CODE	RIF. ORIGINALE OEM NUMBER			CODICE RMS RMS CODE	RIF. ORIGINALE OEM NUMBER		
50	Vespa Pk FL 2 Automatico	90-91	□	18 410 0261	274546						
50	Vespa Pk FL 2 Hp	91-97	□	18 410 0261	274546						
50	Vespa Sprint 2T 2V	14	□	18 410 0601	564683		●	18 412 0711	497042	H.T.	●
50	Vespa Sprint 4T 4V	14	□	18 410 0601	564683		●	18 412 0711	497042	H.T.	●
50	Zip	92-93	■	18 410 0170	269070						
50	Zip	95-96	■	18 410 0111	564689			18 412 0231	494951		
50	Zip	00-04	■	18 410 0591	564682		●	18 412 0111	494952	Gri.	
50	Zip	00-04	■	18 410 0531	562450						
50	Zip 2T	08-10	■	18 410 0591	564682		●	18 412 0651	497041	H.T.	
50	Zip 4T	00-05	■	18 410 0531	562450			18 412 0111	494952	Gri.	
50	Zip 4T	06-10	■	18 410 0531	562450			18 412 0651	497041	H.T.	
50	Zip 4T	06-10	■	18 410 0591	564682		●				
50	Zip Bimodale	94-97	■	18 410 0170	269070						
50	Zip Fast Raider	93-94	■	18 410 0111	564689			18 412 0231	494951		
50	Zip Fast Raider Rst	96-97	■	18 410 0111	564689			18 412 0231	494951		
50	Zip Rst Freno Disco/Disc	96-99	■	18 410 0111	564689			18 412 0231	494951		
50	Zip Rst Freno tamb./Drum	96-99	■	18 410 0111	564689			18 412 0091	564690		
50	Zip Sp	96-00	■	18 410 0111	564689			18 412 0231	494951		
50	Zip Sp	01-04	■	18 410 0531	562450			18 412 0651	497041	H.T.	
50	Zip Sp	01-04	■	18 410 0591	564682		●	18 412 0111	494952	Gri.	
50	Zip Sp Eu2	06-09	■	18 410 0531	562450			18 412 0651	497041	H.T.	
50	Zip Sp Eu2	06-09	■	18 410 0591	564682		●				
100	Fly 4T	06-07	□	18 410 0181	561131			18 412 0731	646803	Gri.	●
100	Fly 4T	06-07	□	18 410 0601	564683		●	18 412 0731	646803	Gri.	●
100	Fly 4T	06-07	□	18 410 0181	561131			18 412 0652	646833	H.T.	
100	Fly 4T	06-07	□	18 410 0601	564683		●	18 412 0711	497042	H.T.	●
100	Free	02-03	■	18 410 0111	564689			18 412 0091	564690		
100	Zip 4T	06-10	■	18 410 0591	564682		●				
125	Beverly	01-03	■	18 412 0601	646829	Bre.		18 412 0601	646829	Bre.	
125	Beverly	01-03	■	18 412 0721	497031	Bre.	●	18 412 0721	497031	Bre.	●
125	Beverly	01-03	■	18 412 0661	600475	H.T.	●	18 412 0661	600475	H.T.	●
125	Beverly Eu3	07-08	■	18 412 0721	497031	Bre.	●	18 412 0721	497031	Bre.	●
125	Beverly Eu3	07-08	■	18 412 0601	646829	Bre.		18 412 0601	646829	Bre.	
125	Beverly Eu3	07-08	■	18 412 0661	600475	H.T.	●	18 412 0661	600475	H.T.	●
125	Beverly Eu3 Mic	07	■	18 412 0721	497031	Bre.	●	18 412 0721	497031	Bre.	●
125	Beverly Eu3 Mic	07	■	18 412 0601	646829	Bre.		18 412 0601	646829	Bre.	
125	Beverly Eu3 Mic	07	■	18 412 0661	600475	H.T.	●	18 412 0661	600475	H.T.	●
125	Beverly Eu3 Sport	07-08	■	18 412 0661	600475			18 412 0601	646829	Bre.	
125	Beverly Eu3 Sport	07-08	■	18 412 0661	600475	H.T.	●	18 412 0661	600475	H.T.	●
125	Beverly Rst	04-07	■	18 412 0661	600475	H.T.	●	18 412 0661	600475	H.T.	●
125	Beverly Rst	06-07	■	18 412 0601	646829	Bre.		18 412 0601	646829	Bre.	
125	Beverly Rst	06-07	■	18 412 0721	497031	Bre.	●	18 412 0721	497031	Bre.	●
125	Beverly Rst 4T 4V Ie Eu3	10-11	■	18 412 0661	600475	H.T.	●	18 412 0721	497031	Bre.	●
125	Beverly Tourer Eu3	08-09	■	18 412 0601	646829	Bre.		18 412 0601	646829	Bre.	
125	Beverly Tourer Eu3	08-09	■	18 412 0721	497031	Bre.	●	18 412 0721	497031	Bre.	●
125	Beverly Tourer Eu3	08-09	■	18 412 0661	600475	H.T.	●	18 412 0661	600475	H.T.	●
125	Carnaby	07-09	■	18 412 0601	646829	Bre.		18 412 0601	646829	Bre.	

● Terminale grosso - Big end lever
 ■ Colore nero - Black
 □ Colore lucido - Glossy

GRI Grimeca
 H.T. Heng Tong
 BRE Brembo

DX Destra - Right
 SX Sinistra - Left

LEVE
LEVERS



CC	MODELLO - MODEL	ANNO YEAR	COLORE - COLOUR	SINISTRA - LEFT		IMPIANTO SYSTEM	TERMINALE TERMINAL	DESTRA - RIGHT		IMPIANTO SYSTEM	TERMINALE TERMINAL
				CODICE RMS RMS CODE	RIF. ORIGINALE OEM NUMBER			CODICE RMS RMS CODE	RIF. ORIGINALE OEM NUMBER		
125	Carnaby	07-09	■	18 412 0721	497031	Bre.	●	18 412 0721	497031	Bre.	●
125	Carnaby	07-09	■	18 412 0661	600475	H.T.	●	18 412 0661	600475	H.T.	●
125	Fly	05-07	□	18 410 0181	561131			18 412 0731	646803	Gri.	●
125	Fly	05-07	□	18 410 0601	564683		●	18 412 0731	646803	Gri.	●
125	Fly	05-07	□	18 410 0181	561131			18 412 0652	646833	H.T.	
125	Fly	05-07	□	18 410 0601	564683		●	18 412 0711	497042	H.T.	●
125	Fly Eu3	07	□	18 410 0181	561131			18 412 0731	646803	Gri.	●
125	Fly Eu3	07	□	18 410 0601	564683		●	18 412 0731	646803	Gri.	●
125	Fly Eu3	08	□	18 410 0181	561131			18 412 0731	646803	Gri.	●
125	Fly Eu3	08	□	18 410 0601	564683		●	18 412 0731	646803	Gri.	●
125	Fly Eu3	08	□	18 410 0181	561131			18 412 0652	646833	H.T.	
125	Fly Eu3	08	□	18 410 0601	564683		●	18 412 0711	497042	H.T.	●
125	Hexagon	94-97	■					18 412 0111	494952	Gri.	
125	Hexagon Gtx	00	■					18 412 0111	494952	Gri.	
125	Hexagon Lx-Lxt	98-99	□	18 410 0181	561131			18 412 0731	646803	Gri.	●
125	Hexagon Lx-Lxt	98-99	□	18 410 0601	564683		●	18 412 0731	646803	Gri.	●
125	Hexagon Lx4	98-99	□	18 410 0181	561131			18 412 0731	646803	Gri.	●
125	Hexagon Lx4	98-99	□	18 410 0601	564683		●	18 412 0731	646803	Gri.	●
125	Hexagon Lx4	98-99	■					18 412 0111	494952	Gri.	
125	Liberty	98-02	□	18 410 0201	564642			18 412 0261	494948	Gri.	
125	Liberty	01-02	□	18 410 0201	564642			18 412 0641	497039	H.T.	
125	Liberty 4T	06-07	□	18 410 0181	561131			18 412 0731	646803	Gri.	●
125	Liberty 4T	06-07	□	18 410 0601	564683		●	18 412 0731	646803	Gri.	●
125	Liberty 4T	06-07	□	18 410 0181	561131			18 412 0652	646833	H.T.	
125	Liberty 4T	06-07	□	18 410 0601	564683		●	18 412 0711	497042	H.T.	●
125	Liberty 4T Eu3	07-08	□	18 410 0181	561131			18 412 0731	646803	Gri.	●
125	Liberty 4T Eu3	07-08	□	18 410 0601	564683		●	18 412 0731	646803	Gri.	●
125	Liberty 4T Eu3	07-08	□	18 410 0181	561131			18 412 0652	646833	H.T.	
125	Liberty 4T Eu3	07-08	□	18 410 0601	564683		●	18 412 0711	497042	H.T.	●
125	Liberty 4T Eu3 Delivery	08	□	18 410 0731	648083			18 412 0731	646803	Gri.	●
125	Liberty 4T Eu3 Delivery	08	□	18 410 0731	648083			18 412 0652	646833	H.T.	
125	Liberty 4T Sport Eu3	06-08	□	18 410 0181	561131			18 412 0711	497042	H.T.	
125	Liberty 4T Sport Eu3	06-08	□	18 410 0601	564683		●	18 412 0731	646803	Gri.	●
125	Liberty 4T Sport Eu3	06-08	□	18 410 0181	561131			18 412 0652	646833	H.T.	
125	Liberty 4T Sport Eu3	06-08	□	18 410 0601	564683		●	18 412 0711	497042	H.T.	●
125	Liberty Moc 4T & Elle	09-10	□	18 410 0181	561131			18 412 0652	646833	H.T.	
125	Liberty Moc 4T & Elle	09-10	□	18 410 0601	564683		●	18 412 0711	497042	H.T.	●
125	Liberty Rst	04-05	□	18 410 0181	561131			18 412 0652	646833	H.T.	
125	Liberty Rst	04-05	□	18 410 0601	564683		●	18 412 0711	497042	H.T.	●
125	Liberty Rst Ptt	05-06	□	18 410 0731	648083			18 412 0731	646803	Gri.	●
125	Liberty Rst Ptt	05-06	□	18 410 0731	648083			18 412 0652	646833	H.T.	
125	Liberty Sport	06	□	18 410 0181	561131			18 412 0711	497042	H.T.	
125	Liberty Sport	06	□	18 410 0601	564683		●	18 412 0731	646803	Gri.	●
125	Liberty Sport	06	□	18 410 0181	561131			18 412 0652	646833	H.T.	
125	Liberty Sport	06	□	18 410 0601	564683		●	18 412 0711	497042	H.T.	●
125	Mp3	07-08	■	18 412 0661	600475	H.T.	●	18 412 0721	497031	Bre.	●
125	Mp3 Ibrido	09-10	■	18 412 0661	600475	H.T.	●	18 412 0721	497031	Bre.	●



LEVE LEVERS

CC	MODELLO - MODEL	ANNO YEAR	COLORE - COLOUR	SINISTRA - LEFT		IMPIANTO SYSTEM	TERMINALE TERMINAL	DESTRA - RIGHT		IMPIANTO SYSTEM	TERMINALE TERMINAL
				CODICE RMS RMS CODE	RIF. ORIGINALE OEM NUMBER			CODICE RMS RMS CODE	RIF. ORIGINALE OEM NUMBER		
125	Mp3 le	08-09	■	18 412 0661	600475	H.T.	●	18 412 0721	497031	Bre.	●
125	Mp3 Yourban Erl	11	■	18 412 0661	600475	H.T.	●	18 412 0721	497031	Bre.	●
125	Skipper	94-97	■	18 410 0111	564689			18 412 0231	494951		
125	Skipper 4T	00-02	■					18 412 0111	494952	Gri.	
125	Skipper 4T	00-02	■					18 412 0651	497041	H.T.	
125	Skipper Lx	98-99	■					18 412 0111	494952	Gri.	
125	Skipper Lx	98-99	■	18 410 0861	564681			18 412 0651	497041	H.T.	
125	Super Hexagon Gtx 12	01-02	■	18 410 0111	564689			18 412 0111	494952	Gri.	
125	Super Hexagon Gtx 12	01-02	■	18 410 0111	564689			18 412 0651	497041	H.T.	
125	Typhoon 4T 2V Eu3	10-11	■								
125	Typhoon 4T 2V Eu3	10-11	■	18 410 0861	564681			18 412 0651	497041	H.T.	
125	Skipper 4T	00-02	■	18 410 0861	564681			18 412 0651	497040	H.T.	
125	Vespa Et4	96-02	□	18 410 0201	564642			18 412 0261	494948	Gri.	
125	Vespa Et4	99-02	□	18 410 0201	564642			18 412 0641	497039	H.T.	
125	Vespa FL	89-90	■					18 412 0280	265947		
125	Vespa Granturismo	03-05	□	18 412 0652	646833	H.T.		18 412 0652	646833	H.T.	
125	Vespa Granturismo	06-07	□	18 412 0711	497042	H.T.	●	18 412 0711	497042	H.T.	●
125	Vespa Granturismo Eu3	06-07	□	18 412 0711	497042	H.T.	●	18 412 0711	497042	H.T.	●
125	Vespa Gts 4T le Super	09-11	□	18 412 0711	497042	H.T.	●	18 412 0711	497042	H.T.	●
125	Vespa Gts Eu3	07-12	□	18 412 0711	497042	H.T.	●	18 412 0711	497042	H.T.	●
125	Vespa Gts Eu3	07-12	□	18 412 0652	646833	H.T.		18 412 0652	646833	H.T.	
125	Vespa Lx	05-06	□	18 410 0601	564683		●	18 412 0731	646803	Gri.	●
125	Vespa Lx	05-06	□	18 410 0181	561131			18 412 0652	646833	H.T.	
125	Vespa Lx	05-06	□	18 410 0601	564683		●	18 412 0711	497042	H.T.	●
125	Vespa Lx 4T FL	09	□	18 410 0181	561131			18 412 0652	646833	H.T.	
125	Vespa Lx 4T FL	09	□	18 410 0601	564683		●	18 412 0711	497042	H.T.	●
125	Vespa Lx 4T 3V le - Touring	12-13	□	18 410 0601	564683		●	18 412 0711	497042	H.T.	●
125	Vespa Lx Eu3	06-08	□	18 410 0181	561131			18 412 0731	646803	Gri.	●
125	Vespa Lx Eu3	06-08	□	18 410 0601	564683		●	18 412 0731	646803	Gri.	●
125	Vespa Lx Eu3	06-08	□	18 410 0181	561131			18 412 0652	646833	H.T.	
125	Vespa Lx Eu3	06-08	□	18 410 0601	564683		●	18 412 0711	497042	H.T.	●
125	Vespa Lx Eu3 le	09-10	□	18 410 0601	564683		●	18 412 0711	497042	H.T.	●
125	Vespa Lx Eu3 le	09-10	□	18 410 0181	561131			18 412 0652	646833	H.T.	
125	Vespa Lx Touring	10-11	□	18 410 0181	561131			18 412 0652	646833	H.T.	
125	Vespa Lx Touring	10-11	□	18 410 0601	564683		●	18 412 0711	497042	H.T.	●
125	Vespa Lxv 4T	06-12	□	18 410 0821	648115						
125	Vespa Lx Primavera 4T 3V le	13-14	□	18 410 0601	564683		●	18 412 0711	497042	H.T.	●
125	Vespa Lxv le 4T	10-13	□	18 410 0821	648115						
125	Vespa S 4T 3V le	12	□	18 410 0601	564683		●	18 412 0711	497042	H.T.	●
125	Vespa S 4T Eu3	07-08	□	18 410 0181	561131			18 412 0731	646803	Gri.	●
125	Vespa S 4T Eu3	07-08	□	18 410 0601	564683		●	18 412 0731	646803	Gri.	●
125	Vespa S 4T Eu3	07-08	□	18 410 0181	561131			18 412 0652	646833	H.T.	
125	Vespa S 4T Eu3	07-08	□	18 410 0601	564683		●	18 412 0711	497042	H.T.	●
125	Vespa S 4T le & College	09-11	□	18 410 0181	561131			18 412 0652	646833	H.T.	
125	Vespa S 4T le & College	09-11	□	18 410 0601	564683		●	18 412 0711	497042	H.T.	●
125	Vespa Sprint 4T 3V le	14	□	18 410 0601	564683		●	18 412 0711	497042	H.T.	●
125	X Evo	07-12	■	18 412 0661	600475	H.T.	●	18 412 0661	600475	H.T.	●

● Terminale grosso - *Big end lever*
 ■ Colore nero - *Black*
 □ Colore lucido - *Glossy*

GRI Grimeca
 H.T. Heng Tong
 BRE Brembo

DX Destra - *Right*
 SX Sinistra - *Left*

LEVE
LEVERS



CC	MODELLO - MODEL	ANNO YEAR	COLORE - COLOUR	SINISTRA - LEFT		IMPIANTO SYSTEM	TERMINALE TERMINAL	DESTRA - RIGHT		IMPIANTO SYSTEM	TERMINALE TERMINAL
				CODICE RMS RMS CODE	RIF. ORIGINALE OEM NUMBER			CODICE RMS RMS CODE	RIF. ORIGINALE OEM NUMBER		
125	X7 Eu3	08	■	18 412 0661	600475	H.T.	●	18 412 0661	600475	H.T.	●
125	X7 Evo Ie Eu3	09-10	■	18 412 0661	600475	H.T.	●	18 412 0661	600475	H.T.	●
125	X8	04	■	18 412 0661	600475	H.T.	●	18 412 0661	600475	H.T.	●
125	X8	05-06	■	18 412 0661	600475	H.T.	●	18 412 0661	600475	H.T.	●
125	X8 Premium Eu2	06	■	18 412 0661	600475	H.T.	●	18 412 0661	600475	H.T.	●
125	X8 Premium Eu3	06-07	■	18 412 0661	600475	H.T.	●	18 412 0661	600475	H.T.	●
125	X8 Street Eu2	06-07	■	18 410 0851	647552			18 412 0661	600475	H.T.	●
125	X9	01-02	■	18 410 0601	564683		●	18 412 0601	646829	Bre.	
125	X9 Evolution	03	■	18 412 0721	497031	Bre.	●	18 412 0721	497031	Bre.	●
125	X9 Evolution	05-07	■	18 412 0661	600475	H.T.	●	18 412 0661	600475	H.T.	●
125	X9 Evolution Eu3	07	■	18 412 0661	600475	H.T.	●	18 412 0661	600475	H.T.	●
125	Zip	00-02	■	18 410 0531	562450			18 412 0111	494952	Gri.	
150	Fly	05-07	□	18 410 0181	561131			18 412 0731	646803	Gri.	●
150	Fly	05-07	□	18 410 0601	564683		●	18 412 0731	646803	Gri.	●
150	Fly	05-07	□	18 410 0181	561131			18 412 0652	646833	H.T.	
150	Fly	05-07	□	18 410 0601	564683		●	18 412 0711	497042	H.T.	●
150	Fly Eu3	08-10	□	18 410 0181	561131			18 412 0731	646803	Gri.	●
150	Fly Eu3	08-10	□	18 410 0601	564683		●	18 412 0731	646803	Gri.	●
150	Fly Eu3	08-10	□	18 410 0181	561131			18 412 0652	646833	H.T.	
150	Fly Eu3	08-10	□	18 410 0601	564683		●	18 412 0711	497042	H.T.	●
150	Liberty 4T Eu3	08	□	18 410 0601	564683		●	18 412 0731	646803	Gri.	●
150	Liberty 4T Eu3	08	□	18 410 0181	561131			18 412 0731	646803	Gri.	●
150	Liberty 4T Eu3	08	□	18 410 0181	561131			18 412 0652	646833	H.T.	
150	Liberty 4T Eu3	08	□	18 410 0601	564683		●	18 412 0711	497042	H.T.	●
150	Liberty 4T Sport Eu3	08	□	18 410 0181	561131			18 412 0731	646803	Gri.	●
150	Liberty 4T Sport Eu3	08	□	18 410 0601	564683		●	18 412 0731	646803	Gri.	●
150	Liberty 4T Sport Eu3	08	□	18 410 0181	561131			18 412 0652	646833	H.T.	
150	Liberty 4T Sport Eu3	08	□	18 410 0601	564683		●	18 412 0711	497042	H.T.	●
150	Liberty Moc 4T	09-10	□	18 410 0181	561131			18 412 0652	646833	H.T.	
150	Liberty Moc 4T	09-10	□	18 410 0601	564683		●	18 412 0711	497042	H.T.	●
150	Vespa Lx	05-06	□	18 410 0181	561131			18 412 0731	646803	Gri.	●
150	Vespa Lx	05-06	□	18 410 0601	564683		●	18 412 0731	646803	Gri.	●
150	Vespa Lx	05-06	□	18 410 0181	561131			18 412 0652	646833	H.T.	
150	Vespa Lx	05-06	□	18 410 0601	564683		●	18 412 0711	497042	H.T.	●
150	Vespa Lx 4T FL	09	□	18 410 0181	561131			18 412 0652	646833	H.T.	
150	Vespa Lx 4T FL	09	□	18 410 0601	564683		●	18 412 0711	497042	H.T.	●
150	Vespa Lx 4T 3V Ie - Touring	12-13	□	18 410 0601	564683		●	18 412 0711	497042	H.T.	●
150	Vespa Lx Eu3	06-08	□	18 410 0181	561131			18 412 0731	646803	Gri.	●
150	Vespa Lx Eu3	06-08	□	18 410 0601	564683		●	18 412 0731	646803	Gri.	●
150	Vespa Lx Eu3	06-08	□	18 410 0181	561131			18 412 0652	646833	H.T.	
150	Vespa Lx Eu3	06-08	□	18 410 0601	564683		●	18 412 0711	497042	H.T.	●
150	Vespa Lx Eu3 Ie	09-11	□	18 410 0181	561131			18 412 0652	646833	H.T.	
150	Vespa Lx Eu3 Ie	09-11	□	18 410 0601	564683		●	18 412 0711	497042	H.T.	●
150	Vespa Lx Touring	10-12	□	18 410 0181	561131			18 412 0652	646833	H.T.	
150	Vespa Lx Touring	10-12	□	18 410 0601	564683		●	18 412 0711	497042	H.T.	●
150	Vespa Primavera 4T-3V	13-14	□	18 410 0601	564683		●	18 412 0711	497042	H.T.	●
150	Vespa S 4T	08-09	□	18 410 0181	561131			18 412 0731	646803	Gri.	●



LEVE LEVERS

CC	MODELLO - MODEL	ANNO YEAR	COLORE - COLOUR	SINISTRA - LEFT		IMPIANTO SYSTEM	TERMINALE TERMINAL	DESTRA - RIGHT		IMPIANTO SYSTEM	TERMINALE TERMINAL
				CODICE RMS RMS CODE	RIF. ORIGINALE OEM NUMBER			CODICE RMS RMS CODE	RIF. ORIGINALE OEM NUMBER		
150	Vespa S 4T	08-09	□	18 410 0601	564683		●	18 412 0711	497042	H.T.	●
150	Vespa S 4T	08-09	□	18 410 0181	561131			18 412 0652	646833	H.T.	
150	Vespa S 4T	08-09	□	18 410 0601	564683		●	18 412 0711	497042	H.T.	●
150	Vespa S 4T Ie & College	09-12	□	18 410 0181	561131			18 412 0652	646833	H.T.	
150	Vespa S 4T Ie & College	09-12	□	18 410 0601	564683		●	18 412 0711	497042	H.T.	●
150	X8 Street Eu2	06-08	■	18 410 0851	647552			18 412 0661	600475	H.T.	●
180	Hexagon Gtx	00	■	18 412 0111	494952	Gri.		18 412 0111	494952	Gri.	
180	X9 Amalfi	00-03	■	18 410 0601	564683		●	18 412 0601	646829	Bre.	
200	Beverly	01-03	■	18 412 0601	646829	Bre.		18 412 0601	646829	Bre.	
200	Beverly	01-03	■	18 412 0661	600475	H.T.	●	18 412 0661	600475	H.T.	●
200	Carnaby	07-08	■	18 412 0721	497031	Bre.	●	18 412 0721	497031	Bre.	●
200	Carnaby	07-08	■	18 412 0601	646829	Bre.		18 412 0601	646829	Bre.	
200	Carnaby	07-08	■	18 412 0661	600475	H.T.	●	18 412 0661	600475	H.T.	●
200	Liberty	06	□	18 412 0601	646829	Bre.		18 412 0731	646803	Gri.	●
200	Liberty	06	□	18 410 0181	561131			18 412 0731	646803	Gri.	●
200	Liberty	06	□	18 410 0181	561131			18 412 0652	646833	H.T.	
200	Liberty	06	□	18 410 0601	564683		●	18 412 0711	497042	H.T.	●
200	Liberty 4T Eu3	07-08	□	18 410 0181	561131			18 412 0731	646803	Gri.	●
200	Liberty 4T Eu3	07-08	□	18 410 0601	564683		●	18 412 0731	646803	Gri.	●
200	Liberty 4T Eu3	07-08	□	18 410 0181	561131			18 412 0652	646833	H.T.	
200	Liberty 4T Eu3	07-08	□	18 410 0601	564683		●	18 412 0652	646833	H.T.	
200	Liberty 4T Sport Eu3	06-07	□	18 410 0181	561131			18 412 0731	646803	Gri.	●
200	Liberty 4T Sport Eu3	06-07	□	18 410 0601	564683		●	18 412 0731	646803	Gri.	●
200	Liberty 4T Sport Eu3	06-07	□	18 410 0181	561131			18 412 0652	646833	H.T.	
200	Liberty 4T Sport Eu3	06-07	□	18 410 0601	564683		●	18 412 0711	497042	H.T.	●
200	Liberty Rst	04	□	18 410 0181	561131			18 412 0731	646803	Gri.	●
200	Liberty Rst	04	□	18 410 0601	564683		●	18 412 0711	497042	H.T.	●
200	Liberty Sport	06	□	18 410 0181	561131			18 412 0731	646803	Gri.	●
200	Liberty Sport	06	□	18 410 0601	564683		●	18 412 0731	646803	Gri.	●
200	Liberty Sport	06	□	18 410 0181	561131			18 412 0652	646833	H.T.	
200	Liberty Sport	06	□	18 410 0601	564683		●	18 412 0711	497042	H.T.	●
200	Vespa Granturismo	06-07	□	18 412 0711	497042	H.T.	●	18 412 0711	497042	H.T.	●
200	X8	05-07	■	18 412 0661	600475	H.T.	●	18 412 0661	600475	H.T.	●
200	X9	02-03	■	18 412 0601	646829	Bre.		18 412 0601	646829	Bre.	
200	X9 Evolution	03	■	18 412 0721	497031	Bre.	●	18 412 0721	497031	Bre.	●
250	Beverly	06-07	■	18 412 0721	497031	Bre.	●	18 412 0721	497031	Bre.	●
250	Beverly	06-07	■	18 412 0661	600475	H.T.	●	18 412 0661	600475	H.T.	●
250	Beverly Eu3 Mic	07	■	18 412 0721	497031	Bre.	●	18 412 0721	497031	Bre.	●
250	Beverly Eu3 Mic	07	■	18 412 0601	646829	Bre.		18 412 0601	646829	Bre.	
250	Beverly Eu3 Mic	07	■	18 412 0661	600475	H.T.	●	18 412 0661	600475	H.T.	●
250	Beverly Ie Eu3	06-08	■	18 412 0601	646829	Bre.		18 412 0601	646829	Bre.	
250	Beverly Ie Eu3	06-08	■	18 412 0721	497031	Bre.	●	18 412 0721	497031	Bre.	●
250	Beverly Ie Eu3	06-08	■	18 412 0661	600475	H.T.	●	18 412 0661	600475	H.T.	●
250	Beverly Rst	04-05	■	18 412 0601	646829	Bre.		18 412 0601	646829	Bre.	
250	Beverly Rst	04-05	■	18 412 0661	600475	H.T.	●	18 412 0661	600475	H.T.	●
250	Beverly Rst	04-05	■	18 412 0721	497031	Bre.	●	18 412 0721	497031	Bre.	●
250	Beverly Sport	06-08	■	18 412 0721	497031	Bre.	●	18 412 0721	497031	Bre.	●

● Terminale grosso - Big end lever
 ■ Colore nero - Black
 □ Colore lucido - Glossy

GRI Grimeca
 H.T. Heng Tong
 BRE Brembo

DX Destra - Right
 SX Sinistra - Left

LEVE
LEVERS



CC	MODELLO - MODEL	ANNO YEAR	COLORE - COLOUR	SINISTRA - LEFT		IMPIANTO SYSTEM	TERMINALE TERMINAL	DESTRA - RIGHT		IMPIANTO SYSTEM	TERMINALE TERMINAL
				CODICE RMS RMS CODE	RIF. ORIGINALE OEM NUMBER			CODICE RMS RMS CODE	RIF. ORIGINALE OEM NUMBER		
250	Beverly Sport	06-08	■	18 412 0661	600475	H.T.	●	18 412 0661	600475	H.T.	●
250	Beverly Tourer Eu3	08-09	■	18 412 0721	497031	Bre.	●	18 412 0721	497031	Bre.	●
250	Beverly Tourer Eu3	08-09	■	18 412 0661	600475	H.T.	●	18 412 0661	600475	H.T.	●
250	Beverly Cruiser	07-09	□	18 412 0921	649196			18 412 0921	649196		
250	Carnaby	08	■	18 412 0721	497031	Bre.	●	18 412 0721	497031	Bre.	●
250	Carnaby	08	■	18 412 0661	600475	H.T.	●	18 412 0661	600475	H.T.	●
250	Hexagon Gtx	00	■	18 412 0111	494952	Gri.		18 412 0111	494952	Gri.	
250	Hexagon Gt-Gtx	98-00	□					18 412 0731	646803	Gri.	●
250	Hexagon Gt-Gtx	98-00	□	18 412 0731	646803	Gri.	●	18 412 0731	646803	Gri.	●
250	Mp3	06-08	■	18 412 0661	600475	H.T.	●	18 412 0601	646829	Bre.	
250	Mp3 Lt	09	■	18 412 0661	600475	H.T.	●	18 412 0721	497031	Bre.	●
250	Mp3 Mic	08-09	■	18 412 0661	600475	H.T.	●	18 412 0721	497031	Bre.	●
250	Vespa Gts, Gts Abs	05-13	□	18 412 0731	646803	Gri.	●	18 412 0731	646803	Gri.	●
250	Vespa Gts, Gts Abs	05-13	□	18 412 0711	497042	H.T.	●	18 412 0711	497042	H.T.	●
250	Vespa Gts, Gts Abs	05-13	□	18 412 0652	646833	H.T.		18 412 0652	646833	H.T.	
250	X Evo	07-13	■	18 412 0661	600475	H.T.	●	18 412 0661	600475	H.T.	●
250	X7 Eu3	08	■	18 412 0661	600475	H.T.	●	18 412 0661	600475	H.T.	●
250	X8 Eu3	05-08	■	18 412 0661	600475	H.T.	●	18 412 0661	600475	H.T.	●
250	X9	00-01	■	18 412 0721	497031	Bre.	●	18 412 0721	497031	Bre.	●
250	X9	00-01	■	18 412 0601	646829	Bre.		18 412 0601	646829	Bre.	
250	X9 Evolution	04-06	■	18 412 0661	600475	H.T.	●	18 412 0661	600475	H.T.	●
300	Beverly Tourer Eu3	09-10	■	18 412 0721	497031	Bre.	●	18 412 0721	497031	Bre.	●
300	Beverly Tourer Eu3	09-10	■	18 412 0661	600475	H.T.	●	18 412 0661	600475	H.T.	●
300	Beverly Rst 4T 4V le Eu3	10-14	■	18 412 0661	600475	H.T.	●	18 412 0721	497031	Bre.	●
300	Carnaby Cruiser	09-12	■	18 412 0661	600475	H.T.	●	18 412 0661	600475	H.T.	●
300	Canrnaby Cruiser	09-12	□	18 412 1001	665870	H.T.	●	18 412 1001	665870	H.T.	●
300	Mp3 le LT	10-11	■	18 412 0661	600475	H.T.	●	18 412 0721	497031	Bre.	●
300	Mp3 le Mic	10-11	■	18 412 0661	600475	H.T.	●	18 412 0721	497031	Bre.	●
300	Mp3 4T 4V le Lt Ibrido	10 -13	■	18 412 0661	600475	H.T.	●	18 412 0721	497031	Bre.	●
300	Mp3 Yourban Erl	11	■	18 412 0661	600475	H.T.	●	18 412 0721	497031	Bre.	●
300	Vespa Gts le	12-14	□	18 412 0711	497042	H.T.	●	18 412 0711	497042	H.T.	●
300	Vespa Gts le Touring	11-12	□	18 412 0711	497042	H.T.	●	18 412 0711	497042	H.T.	●
300	Vespa Gts Super	08-10	□	18 412 0711	497042	H.T.	●	18 412 0711	497042	H.T.	●
300	Vespa Gts Super	08-10	□	18 412 0652	646833	H.T.		18 412 0652	646833	H.T.	
300	Vespa Gts Super Sport	10-13	□	18 412 0711	497042	H.T.	●	18 412 0652	646833	H.T.	
300	X7 Evo le Eu3	09-10	■	18 412 0661	600475	H.T.	●	18 412 0661	600475	H.T.	●
350	Beverly 4T 4V le	11-14	■	18 412 0601	646829	Bre.		18 412 0601	646829	Bre.	
400	Beverly Eu3	06-07	■	18 412 0601	646829	Bre.		18 412 0601	646829	Bre.	
400	Beverly Eu3	06-07	■	18 412 0721	497031	Bre.	●	18 412 0721	497031	Bre.	●
400	Beverly Eu3	06-07	■	18 412 0661	600475	H.T.	●	18 412 0721	497031	Bre.	●
400	Beverly Tourer Eu3	08-10	■	18 412 0721	497031	Bre.	●	18 412 0721	497031	Bre.	●
400	Beverly Tourer Eu3	08-09	■	18 412 0601	646829	Bre.		18 412 0601	646829	Bre.	
400	Beverly Tourer Eu3	08-09	■	18 412 0661	600475	H.T.	●	18 412 0721	497031	Bre.	●
400	Mp3	07-08	■	18 412 0661	600475	H.T.	●	18 412 0721	497031	Bre.	●
400	Mp3 le Lt Touring	11	■	18 412 0661	600475	H.T.	●	18 412 0721	497031	Bre.	●
400	Mp3 le Lt Sport	08-10	■	18 412 0661	600475	H.T.	●	18 412 0721	497031	Bre.	●
400	Mp3 Mic	08-11	■	18 412 0661	600475	H.T.	●	18 412 0721	497031	Bre.	●



LEVE LEVERS

CC	MODELLO - MODEL	ANNO YEAR	COLORE - COLOUR	SINISTRA - LEFT		IMPIANTO SYSTEM	TERMINALE TERMINAL	DESTRA - RIGHT		IMPIANTO SYSTEM	TERMINALE TERMINAL
				CODICE RMS RMS CODE	RIF. ORIGINALE OEM NUMBER			CODICE RMS RMS CODE	RIF. ORIGINALE OEM NUMBER		
400	X Evo	07-11	■	18 412 0661	600475	H.T.	●	18 412 0721	497031	Bre.	●
400	X8 Eu3	06-08	■	18 412 0661	600475	H.T.	●	18 412 0721	497031	Bre.	●
500	Beverly	02-04	■	18 412 0721	497031	Bre.	●	18 412 0721	497031	Bre.	●
500	Beverly	05-06	■	18 412 0601	646829	Bre.		18 412 0601	646829	Bre.	
500	Beverly	05-06	■	18 412 0661	600475	H.T.	●	18 412 0721	497031	Bre.	●
500	Beverly Eu3	06-08	■	18 412 0721	497031	Bre.	●	18 412 0721	497031	Bre.	●
500	Beverly Eu3	06-08	■	18 412 0601	646829	Bre.		18 412 0601	646829	Bre.	
500	Beverly Eu3	06-08	■	18 412 0661	600475	H.T.	●	18 412 0721	497031	Bre.	●
500	Beverly Cruiser	07-12	□	18 412 0921	649196			18 412 0921	649196		
500	X9	01-02	■	18 412 0721	497031	Bre.	●	18 412 0601	646829	Bre.	
500	X9 Evolution Abs	03-05	□	18 412 0531	600829	Gri.		18 412 0531	600829	Gri.	
500	X9 Evolution	03-05	■	18 412 0601	646829	Bre.		18 412 0601	646829	Bre.	
500	X9 Evolution	06-07	■	18 412 0721	497031	Bre.	●	18 412 0721	497031	Bre.	●
500	X9 Evolution Abs	06-07	□	18 412 0531	600829			18 412 0531	600829		
SUZUKI											
50	Aj Zz Sepia S	95-97	□					18 412 0621	57421-29C00-000		
110	Ug Hokuto	00	□					18 412 0621	57421-29C00-000		
125	An S-Y	95-00	□					18 412 0621	57421-29C00-000		
125	Uc Epicuro X-K1	99-01	□					18 412 0621	57421-29C00-000		
125	Uh Burgman K2-K6	02-03	□	18 410 0521	57500-14F00-000			18 412 0631	57421-14F00-000		
125	Uh Burgman K7-L0	07-10	□	18 410 0521	57500-14F00-000			18 412 0631	57421-14F00-000		
125	Uh Burgman L1	11	□	18 410 0521	57500-14F00-000			18 412 0631	57421-14F00-000		
125	Ux Sixteen K8-L0	08-10	□	18 410 0521	57500-14F00-000			18 412 0631	57421-14F00-000		
125	Ux Sixteen L1	11	□	18 410 0521	57500-14F00-000			18 412 0631	57421-14F00-000		
150	Ant-Y	96-00	□					18 412 0621	57421-29C00-000		
150	Uc Epicuro X-K1	99-01	□					18 412 0621	57421-29C00-000		
150	Uh Burgman K2-K6	02-03	□	18 410 0521	57500-14F00-000			18 412 0631	57421-14F00-000		
150	Ux Sixteen K8-L0	08-10	□	18 410 0521	57500-14F00-000			18 412 0631	57421-14F00-000		
150	Ux Sixteen L1	11	□	18 410 0521	57500-14F00-000			18 412 0631	57421-14F00-000		
200	Uh Burgman K7-L0	07-10	□	18 410 0521	57500-14F00-000			18 412 0631	57421-14F00-000		
200	Uh Burgman L1-L3-L4	11-14	□	18 410 0521	57500-14F00-000			18 412 0631	57421-14F00-000		
250	An Burgman K3-K6	03-06	□	18 410 0521	57500-14F00-000			18 412 0631	57421-14F00-000		
250	An Burgman W-K2	98-02	□	18 410 0521	57500-14F00-000			18 412 0631	57421-14F00-000		
400	An Burgman K3-K6	03-06	□	18 410 0521	57500-14F00-000			18 412 0631	57421-14F00-000		
400	An Burgman K7-L0	07-10	□	18 410 0521	57500-14F00-000			18 412 0631	57421-14F00-000		
400	An Burgman L1-L2-L3	11-13	□	18 410 0521	57500-14F00-000			18 412 0631	57421-14F00-000		
400	An Burgman X-K2	99-02	□	18 410 0521	57500-14F00-000			18 412 0631	57421-14F00-000		
YAMAHA											
50	Bw'S	04-09	■	18 410 0401	5JH-H3912-00			18 412 0481	5JH-H3922-00		
50	Bw'S	10-11	■	18 410 0401	5JH-H3912-10			18 412 0481	5JH-H3922-00		
50	Bw'S Tamburo/Drum		■	18 410 0010				18 412 0010	3VLH39221000		
50	Bw'S Bump	97-98	□	18 410 0161	4SB-H3912-00			18 412 0171	4SB-H3922-00		
50	Bw'S Naked	03	■	18 410 0401	5JH-H3912-00			18 412 0821	5NTH39220000		
50	Bw'S Naked	04	■	18 410 0401	5JH-H3912-00			18 412 0481	5JH-H3922-00		
50	Bw'S Naked	09-11	■	18 410 0401	5JH-H3912-00			18 412 0481	5JH-H3922-00		
50	Bw'S Ng	97-98	□	18 410 0161	4SB-H3912-00			18 412 0171	4SB-H3922-00		
50	Bw'S Ng	01-06	■	18 410 0401	5JH-H3912-00			18 412 0481	5JH-H3922-00		

● Terminale grosso - Big end lever
 ■ Colore nero - Black
 □ Colore lucido - Glossy

GRI Grimeca
 H.T. Heng Tong
 BRE Brembo

DX Destra - Right
 SX Sinistra - Left

LEVE
LEVERS



CC	MODELLO - MODEL	ANNO YEAR	COLORE - COLOUR	SINISTRA - LEFT		IMPIANTO SYSTEM	TERMINALE TERMINAL	DESTRA - RIGHT		IMPIANTO SYSTEM	TERMINALE TERMINAL
				CODICE RMS RMS CODE	RIF. ORIGINALE OEM NUMBER			CODICE RMS RMS CODE	RIF. ORIGINALE OEM NUMBER		
50	Bw'S Ng Cat	99-00	■	18 410 0421	4SB-H3912-10			18 412 0511	4SB-H3922-10		
50	Bw'S Original	97-98	■	18 410 0421	4SB-H3912-10			18 412 0161	4VV-H3922-00		
50	Bw'S Original	99-00	■	18 410 0421	4SB-H3912-10			18 412 0471	4VV-H3922-10		
50	Bw'S Original S. Special	99-00	□	18 410 0161	4SB-H3912-00						
50	Bw'S Original/Eu2	01-03	■	18 410 0401	5JH-H3912-00			18 412 0821	5NTH39220000		
50	Bw'S R	01	■	18 410 0401	5JH-H3912-00			18 412 0821	5NTH39220000		
50	Cw Bw'S L	03	■	18 410 0401	5JH-H3912-00			18 412 0821	5NTH39220000		
50	Cw Bw'S L	04	■	18 410 0401	5JH-H3912-00			18 412 0481	5JH-H3922-00		
50	Cw Bw'S Original Eu2	02	■	18 410 0401	5JH-H3912-00			18 412 0821	5NTH39220000		
50	Cw Bw'S Original Sp	02	■	18 410 0401	5JH-H3912-00			18 412 0821	5NTH39220000		
50	Cw Rs Spy	95-98	□	18 410 0161	4SB-H3912-00			18 412 0181	4TD-H3922-00		
50	Cr Z	91-95	■	18 410 0131	1NT-H3912-00			18 412 0151	2NA-83922-01		
50	Cs Jog R	02-11	■	18 410 0401	5JH-H3912-00			18 412 0891	5RWH392200		
50	Cs Jog R Eu2	02-09	■	18 410 0401	5JH-H3912-00			18 412 0891	5RWH392200		
50	Ct S/Ss	90-95	■	18 410 0131	1NT-H3912-00						
50	Ew Slider	00-02	■	18 410 0401	5JH-H3912-00			18 412 0481	5JH-H3922-00		
50	Ya R Axis	95	■	18 410 0151	4KH-H3912-00			18 412 0151	2NA-83922-01		
50	Ya Za Jog Z	95-96	■					18 412 0151	2NA-83922-01		
50	Yh Why/Eu1/Eu2	98-09	□	18 410 0411	5EU-H3912-00			18 412 0491	5EU-H3922-00		
50	Yq Aerox L/R/Eu2	97-08	□	18 412 0391	5BR-H3912-01			18 412 0391	5BR-H3912-01		
50	Yq Aerox R Replica	08	□	18 412 0391	5BR-H3912-01			18 412 0391	5BR-H3912-01		
50	Yq Aerox	09-12	■	18 412 0841	3C6H3912000			18 412 0841	3C6H3912000		
50	Ym Breeze	94-95	■	18 410 0151	4KH-H3912-00			18 412 0151	2NA-83922-01		
50	Yn Neo'S/Eu2	97-06	□	18 410 0141	5AD-H3912-02			18 412 0401	5AD-H3922-01		
50	Yn Neo'S	07-11	■	18 410 0401	5JH-H3912-00						
50	Yn F Neo's \$	09-11	■	18 410 0401	5JH-H3912-00						
100	Yn Neo'S	00-01	□	18 410 0141	5AD-H3912-02			18 412 0401	5AD-H3922-01		
100	BW'S	99-01	□	18 410 0801	4VPH39121000						
125	BW'S	10	□	18 410 0801	4VPH39121000						
125	NXC CYGNUS	04-11	□	18 410 0781	5MLH39121000			18 412 0871	5MLH39122000		
125	Vp X-City	08-10	■	18 410 0621	1B9-H3922-00			18 412 0751	1B9-H3912-00		
125	Xn Teo'S	00-01	■	18 410 0491	5DS-H3912-01			18 412 0601	5DS-H3922-01		
125	Xq Maxster	01-02	■	18 412 0601	5DS-H3922-01			18 412 0601	5DS-H3922-01		
125	Yp Majesty	99-00	■	18 410 0491	5DS-H3912-01			18 412 0601	5DS-H3922-01		
125	Yp Majesty	01-09	■	18 412 0601	5DS-H3922-01			18 412 0601	5DS-H3922-01		
125	Yp Majesty E	01-09	■	18 412 0601	5DS-H3922-01			18 412 0601	5DS-H3922-01		
125	Yp R X-Max	06-10	■	18 410 0621	1B9-H3922-00			18 412 0751	1B9-H3912-00		
150	Xn Teo'S	00-02	■	18 410 0491	5DS-H3912-01			18 412 0601	5DS-H3922-01		
150	Xq Maxster	01-02	■	18 412 0601	5DS-H3922-01			18 412 0601	5DS-H3922-01		
150	Yp Majesty	00	■	18 410 0491	5DS-H3912-01			18 412 0601	5DS-H3922-01		
150	Yp Majesty	01-02	■	18 412 0601	5DS-H3922-01			18 412 0601	5DS-H3922-01		
180	Yp Majesty E	03-08	■	18 412 0601	5DS-H3922-01			18 412 0601	5DS-H3922-01		
250	Vp X-City	07-10	■	18 410 0621	1B9-H3922-00			18 412 0751	1B9-H3912-00		
250	Yp Majesty	00-03	■	18 410 0501	5CG-83912-10			18 412 0611	5CG-83922-01		
250	Yp Majesty Dx	98-00	■	18 410 0501	5CG-83912-10			18 412 0611	5CG-83922-01		
250	Yp Majesty/Abs	00-06	■	18 410 0501	5CG-83912-10			18 412 0611	5CG-83922-01		
250	Yp R X-Max/Black	05-10	■	18 410 0621	1B9-H3922-00			18 412 0751	1B9-H3912-00		



LEVE LEVERS

CC	MODELLO - MODEL	ANNO YEAR	COLORE - COLOUR	SINISTRA - LEFT		IMPIANTO SYSTEM	TERMINALE TERMINAL	DESTRA - RIGHT		IMPIANTO SYSTEM	TERMINALE TERMINAL
				CODICE RMS RMS CODE	RIF. ORIGINALE OEM NUMBER			CODICE RMS RMS CODE	RIF. ORIGINALE OEM NUMBER		
300	Vp Versity/Xc	03-08	■	18 412 0601	5DS-H3922-01			18 412 0601	5DS-H3922-01		
400	Yp Majesty	04-08	■	18 410 0561	5GJ-83912-00			18 412 0561	5GJ-83922-00		
400	Majesty	09-11	■	18 410 0791	4B5839120000			18 412 0851	4B5839220000		
500	Xp T-Max/Ie/Abs/Black	01-07	■	18 410 0561	5GJ-83912-00			18 412 0561	5GJ-83922-00		
500	Xp T-Max	08-12	■	18 410 0791	4B5839120000			18 412 0851	4B5839220000		
530	Xp T-Max	12-14	■	18 410 0791	4B5839120000			18 412 0851	4B5839220000		
530	Xp T-Max Abs	12-14	■	18 410 0791	4B5839120000			18 412 0851	4B5839220000		

18 404 0020

APRILIA 50: Amico Sport • Lk • Lx • GL • GLE • Amico Yunger • Sr Replica • Urban Kid • Viper
PEUGEOT 50: Sv 125 • Sv



18 404 0040

APRILIA 50: Scarabeo
Freno Disco - *Brake Disc*



18 404 0050

APRILIA 50: Scarabeo 03



18 404 0060

APRILIA 50: Habana • Sr 96 • Sr Wwww



18 404 0580

APRILIA 100: Scarabeo 00-04
Leva nera - *Black lever*



18 404 0590

APRILIA 50: Scarabeo < 05 • Scarabeo 4T < 05
100: Scarabeo 4T 05
Leva nera - *Black lever*



18 404 0570

DERBI 50: Fenix • Senda R Drd • X-Treme Racer • Xrace Sm 06 • X-Treme R • 50m 06
GILERA 50: Rcr • Smt 03



18 404 0090

GILERA 50: Typhoon • Storm 97
Leva in alluminio pressofuso, fulcro leva 29 mm
Die cast aluminium lever, lever fulcrum 29 mm
(R.O. 272002)



18 404 0600

GILERA 50: Typhoon < 05 • Liberty 2T < 05 • Liberty 4T < 05 • Nrg < 02 • Vespa Lx 4T < 05 • Vespa 4T 4V < 08 • Vespa Lx 4T < 05 • Vespa S 2T < 07 • Vespa S-Lx 2T < 05 • Fly 4t < 06
100: Fly 4t < 04
125: Fly 05-08 • Liberty 4T 04-08
150: Fly < 05 • Liberty 4T < 08 Vespa S-Lx < 05 • Vespa S 4T < 08
200: Liberty 4T < 07 • Liberty St < 04 •
Leva nera - *Black lever*
(R.O. CM063804)



18 404 0140

MBK 50: Ovetto
YAMAHA 50: Neo's



18 404 0160

MBK 50: Booster R Spirit



18 404 0520

MBK 50: Booster Next G 00 • Booster Spirit 00
YAMAHA 50: Bw's 00 • Bw's N.G. 00



18 404 0190

PEUGEOT 50: Buxy • Speedake • Zenith
(Destro-Right)



18 404 0100

PIAGGIO 50: Ntt • Nrg • Typhoon Martini
• Typhoon Street



18 404 0110

PIAGGIO 50: Nrg • Thyphoon 97
Leva in alluminio pressofuso, fulcro leva 29 mm
Die cast aluminium lever, lever fulcrum 29 mm
(R.O. 274998)



18 404 0210

PIAGGIO 50: Free 98-99 • Free F1 97
(R.O. 564704 - Ex 560026)



18 404 0240

PIAGGIO 50: Quartz • • Zip Fast Rider
125-150: Skipper
(R.O. 267955)



18 404 0300

PIAGGIO 50: Liberty 2T 97-05 • Liberty 4T 00-02
Vespa ET2 97-05 • Vespa ET2 Iniezione 97-05
50-125: Vespa ET4 90-05
(R.O. 274211)



18 404 0410 

PIAGGIO 50: Ciao Px
(R.O. 188056)
Leva in plastica - *Plastic lever*



18 404 0430 

PIAGGIO 50: Si 90-91
(R.O. 229004)
Leva in alluminio - *Aluminium lever*



18 404 0470 

PIAGGIO 50: Zip Rst 98-99
125: Skipper 94-97
(R.O. 274496)



18 404 0640 

PIAGGIO 50: Liberty 4T Delivery - Single 10-14
125: Liberty 4T Eu3 Delivery - Single 07-12
Modello poste Italiane
(R.O. 601652)



18 404 0650 

PIAGGIO 50: Liberty 4T Delivery Tnt 09 • Liberty 4T Ptt (Deu) 07-12 • Liberty 4T Ptt - Double 09-12 • **125:** Liberty 4T Eu3 Delivery - Tnt 08-09 • Liberty Rst Ptt 05-11
(R.O. 601013)



18 404 0660 

PIAGGIO 50: Ciao Sc 78
(R.O. 162806)
Leva in acciaio - *Steel lever*



COMANDI PORTALEVA  - LEVER SUPPORT

18 404 0631 

KYMCO 50: Agility Carry 11
(R.O. 00153431)



18 408 0020



APRILIA 50: Amico Sport • Lx • Sr 92-93
(R.O. AP8218137)



18 408 0030



APRILIA 50: Scarabeo 97
(R.O. AP8218214)



18 408 0050



APRILIA 50: Scarabeo
Freno Disco - Brake disc



18 408 0080



GILERA 50: Typhoon
PIAGGIO 50: Ape Mix
(R.O. 566485)



18 408 0090



PIAGGIO 50: Nrg 94-96 • Ntt 95-96
(R.O. 564703)



18 408 0100



PIAGGIO 50: Nrg • Typhoon 97
Leva In Alluminio Pressofuso
Die cast aluminium lever
(R.O. 957270)



18 408 0110



APRILIA 50: Sonic • Derbi Atlantis • Italjet
Torpedo • Torpedo • **MBK 50:** Ovetto
PIAGGIO 50-100: Diesis
YAMAHA 50: Neo's **APRILIA 125:** Leonardo
125 St Post 99
150: Leonardo Post 99
250: Leonardo Post 99



18 408 0130



MBK 50: Booster R



18 408 0140



DERBI 50: Vamos
PEUGEOT 50: Buxy • Speedake • Zenith
50-125: Sv
RIZZATO 50: Scooter
Corsa Filo Gas mm 20/70°
Throttle stroke mm 20/70°



18 408 0200



PIAGGIO 50: Zip 95
(R.O. 274531)



18 416 0360



PIAGGIO 125: Liberty • Vespa Et4
Con manopole - *With grips*
(R.O. 560580-2)



18 408 0400



PIAGGIO 50: Free 98-99 • Free F1 97
(R.O. 560026)



18 408 0430

MBK 50: Booster Next G 00 • Booster R 04 •
Mbk Booster Spirit 00 • Stunt
YAMAHA 50: Bw's 00 • Bw's N.G. 00 • Slider •
RIEJU 50: Rs2 Matrix Pro 07 • Rs2 Nkd 07
Senza Manopole - *Without grip*

18 408 0470

PIAGGIO 125: Liberty 4T (Universale)
250: Mp3 Rst • X9 • X7 ie
300: Vespa Gts
400: Beverly
500: X9
(R.O. CM079724)

18 408 0480

PIAGGIO 125-150: Beverly • Mp3 • Vespa Gts
X9 • X Evo
Lunghezza tubo 124 mm
Tube lenght 124 mm
(R.O. CM060975)



18 408 0490

PIAGGIO 50: Nrg • Vespa Lx 4T
125: Beverly
200: Carnaby • Beverly
Senza manopole e trasmissione
Without grip and trasmission
(R.O. CM060915)

18 408 0500

PIAGGIO 50: Vespa Lx 4T
125: Vespa Lx 4T
Lunghezza tubo 112 mm
Tube lenght 112 mm
(R.O. CM060977)

18 408 0330

PIAGGIO 50: Ciao Px 88
Leva in plastica - *Plastic lever*
(R.O. 188057 Ex 178583)



18 408 0350

PIAGGIO 50: Si 90-91
Leva in alluminio - *Aluminium lever*
(R.O. 228969)

18 408 0650

PIAGGIO 50: Ciao Sc
Leva in acciaio - *Steel lever*
(R.O. 162804)

18 408 0510

DERBI 125: Senda Sr 4T • Sm R 06
RIEJU 50: Enduro Smx • Smx Pro > 06 • Mrx •
Mrx Pro 06 • Rr 06 • Smx • Mrx < 06 • Spike 06
1 cavo - *1cable*



18 408 0580



Gas Cross Con Carrucola
Throttle Controls With Pulley
Modello HR Cross
2T, completo di coprigas
2 strokes, with throttle covering
Corsa massima - *Max stroke*
mm 48,5 (36 mm/66°)



18 408 0590



Modello HR Cross - *HR Cross model*
2T, senza manopola
Cross 2 strokes - Without grip
Corsa massima - *Max stroke*
mm 48,5 (36 mm/66°)



18 408 0610



Modello Endross - *Endross Model*
con movimento orizzontale,
ghiera doppia corsa
with horizontal run, dual stroke ring nut
Corsa massima - *Max stroke* mm 48
(versione cross - *cross version* 36 mm/67°)
(versione enduro - *enduro version* 36 mm/78°)



18 408 0540



Modello Commandos - *Commandos model*
Corsa massima - *Max stroke*
Senza manopole - *Without grip*
mm 42 (36 mm/79°)



18 408 0620



Modello Commandos - *Commandos model*
Corsa massima - *Max stroke*
mm 42 (36 mm/79°)
Monocavo - *Single cable*



18 408 0740



KTM Off Road
HUSQVARVA: 4T



18 408 0630



Modello da Trial - *Trial Model*
Corsa massima - *Max stroke*
mm 44 (28 mm/124°)



18 408 0570 

Racing
Corsa massima - *Max stroke mm 44 (36 mm/90°)*
Ghiera Bianca apertura - *White ring opening 55°*
Ghiera Rossa apertura - *Red ring opening 53°*
Ghiera Verde apertura - *Green ring opening 60°*
Senza manopola - *Without grip*



18 408 0680 

MOTO GUZZI 750: Brevia • Nevada • V7 Cafè
Classic • Cafè Racer
(R.O. GU32603310)



18 408 0660 

Moto Rally Cafè racer
Rally Cafè racer Motorcycle
Monocavo - *Single cable*
Corsa massima 25 - *Max stroke mm 25*



18 408 0670 

Moto Modello Lario - *Lario Model*
Monocavo - *Single cable*
Corsa massima 25 - *Max stroke mm 25*



18 408 0550 

Modello Formula - *Formula model*
Con manopole - *With grips*
Corsa massima - *Max stroke*
mm 42 (36 mm/79°)



18 408 0560 

Modello Commandos - *Commandos model*
Senza manopole - *Without grip*
Corsa massima - *Max stroke*
mm 47 (36 mm/75°)



18 408 0530 

Modello Moped - *Moped model*
Corsa massima - *Max stroke*
mm 43 (36 mm/148°) • Monocavo



18 408 0520 

Standard Scooter - *Scooter standard*
2 cavi - *2 cables*



24 609 0120



Dispositivo elettrico mod. USA destro
Funzioni: avviamento motore,
arresto motore (2 posizioni stabili)
USA model Right
Functions: engine start/stop
(2 stable positions)



24 609 0150



Dispositivo elettrico arresto motore
Funzioni: arresto motore, con connettore
Functions: engine stop, with connector



24 609 0160



Dispositivo elettrico avviamento motore
Funzioni: avviamento motore,
con connettore
Functions: engine start, with connector



24 609 0170



Dispositivo elettrico mode computer
Funzioni: mode computer, con connettore
Functions: mode computer, with connector



18 408 0640



Acceleratore elettrico con potenziometro
5 K Ω - durata media 350.000 cicli
Electric accelerator with potentiometer 5K Ω
average life 350.000 actions



12 195 0010 

MOLLA RITORNO LEVA
LEVER RETURN SPRING
Conf. 50 pz. - 50 pcs



12 195 0020 

MOLLA RITORNO LEVA SX
LEVER RETURN SPRING LH
Conf. 50 pz. - 50 pcs



12 185 8250 

REGOLATORE MM 8
MM 8 ADJUSTING SCREW
Conf 10 pz - 10 pcs



12 185 8260 

REGOLATORE MM 5
MM 5 ADJUSTING SCREW
Conf 50 pz - 50 pcs



12 185 8270 

REGOLATORE MM 6
MM 6 ADJUSTING SCREW
Conf 50 pz - 50 pcs



12 185 8280 

NOTTOLINO PER LEVA CROSS
CROSS LEVER RATCHET
Conf 50 pz - 50 pcs



12 185 8290 

NOTTOLINO PER LEVA NYLON
NYLON LEVER RATCHET
Conf 50 pz - 50 pcs



12 185 8480 

CORSOIO CON VITE
SLIDING BLOCK WITH SCREW
PIAGGIO 50: Ciao • Si
(R.O. 229935)



12 186 0310 

SDOPPIATORE - SPLITTER
PIAGGIO 50: Ape • Liberty • Nrg • Typhoon •
Vespa • Zip • Sr • **150:** Hexagon • Skipper
GILERA 50: Runner • Stalker
DERBI 50: Boulevard 2T • Sonar 2T
(R.O. 269571)



18 414 0010

LEVA STARTER - STARTER LEVER
MBK 50: Boster 92 Booster R • Spirit 96
 (F.d. Grimeca)



18 414 0020

COMANDO STARTER - STARTER CONTROL
APRILIA 50: Rally 96 LC (Fd. Grimeca) • Sr 96
 • Sr Viper 93 • Urban Kid 93



18 414 0070

**COMANDO STARTER - STARTER CONTROL
STANDARD**



16 362 0210

**TRASMISSIONE COMANDO GAS
KRR 03 UNIVERSALE**
KRR 03 UNIVERSAL THROTTLE CABLE SET
 Per comando gas 18 408 0570
 For throttle control 18 408 0570



12 186 0300

**KIT PIPETTE GUIDAFILO UNIVERSALI
PER COMANDI GAS XM2**
**KIT OF UNIVERSAL CABLE BENDS
FOR XM2 THROTTLE CONTROLS**
 Per comando gas 18 408 0570
 For throttle control 18 408 0570



▶ MANOPOLE

HAND GRIPS



18 416 0010

Ø 22/24 L. 117 mm.
Scooter 50 Mod. Road
Nero - Black

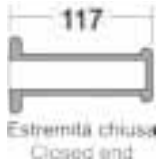

18 416 0020

Ø 22/24 L. 120 mm.
Scooter 50 Mod. GP
Nero - Black

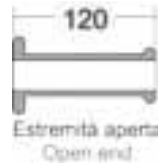

18 416 0040

PIAGGIO 50: Ciao • Si
Nero - Black
(R.O. 185256)

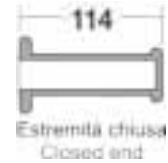

18 416 0050

PIAGGIO 50: Ciao • Si
Nero - Black
(R.O. 233072/5)



18 416 0060

Ø 22/24 Si FL2 • Sfera • Ape
Nero - Black
(R.O. 267205/6)

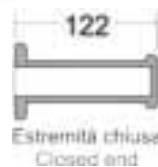

18 416 0070

Ø 22/24 Free FL • Zip 95 • Nrg • Ntt
Nero - Black
(R.O. 274489 - 274490)



18 416 0080

Ø 22/22 Vespa 50 - FL - Hp
Nero - Black
(R.O.274489)

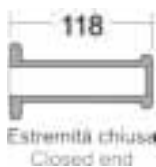

18 416 0150

Mod. Scooter
Nero - Black



18 416 0400

XM2 double super soft per maxiscooter
in gomma termoplastica
XM2 double super soft grips for maxiscooter
in rubber compound
Nero - Grigio - Black - Grey



18 416 0410

XM2 double super soft per maxiscooter
in gomma termoplastica
*XM2 double super soft grips for maxiscooter
in rubber compound*
Nero - Rosso - Black - Red



18 416 0420

XM2 double super soft per maxiscooter
in gomma termoplastica
*XM2 double super soft grips for maxiscooter
in rubber compound*
Nero - Blu - Black - Blue

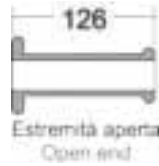

18 416 0430

Manopole bicolore Cross in gomma
termoplastica
Cross two - colour grips in rubber compound
Nero - Rosso - Black - Red



18 416 0440

Manopole bicolore Cross in gomma
termoplastica
Cross two - colour grips in rubber compound
Nero - Giallo - Black - Yellow

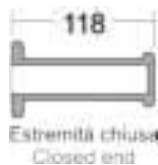

18 416 0450

Manopole bicolore Cross in gomma
termoplastica
Cross two - colour grips in rubber compound
Nero - Grigio - Black - Grey



18 416 0460

Manopole monocolore Cross/Enduro
in gomma termoplastica
*Cross/Enduro monochrome grips
in rubber compound*
Nero - Black

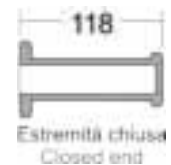

18 416 0470

Manopole monocolore Cross/Enduro
in gomma termoplastica
*Cross/Enduro monochrome grips
in rubber compound*
Azzurra - Blue

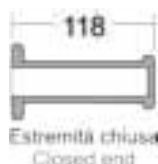

18 416 0480

Manopole monocolore Cross/Enduro
in gomma termoplastica
*Cross/Enduro monochrome grips
in rubber compound*
Rossa - Red

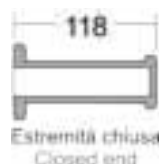

18 416 0500

Manopole bicolore in gomma termoplastica
Two - colour grips in rubber compound
Grigio - Nera - Grey - Black



18 416 0510

Manopole bicolore in gomma termoplastica
Two - colour grips in rubber compound
Nera - Rossa - Black - Red



18 416 0520

Manopole bicolore in gomma termoplastica
Two - colour grips in rubber compound
Nera - Grigia - Black - Grey



18 416 0530

Mod. Dakar lunga
Gomma termoplastica
Rubber compound
Nera - Black



18 416 0540

Mod. Dakar lunga
Gomma termoplastica
Rubber compound
Nera - Black

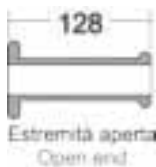

18 416 0570

Mod. Indoor - *Indoor Grips*
Nera - Black



18 416 0580

PIAGGIO 50: Nrg
125-200: Vespa Granturismo • X Evo • X8 • X9
125-200-250: Carnaby • X9
250-300: Gts • Hexagon • 125-200 • X9
400-500: Beverly • X9
Nera - Black
(R.O. 271452/3)

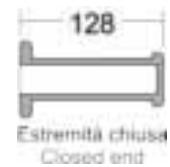

18 416 0590

PIAGGIO: Vespa Gt - Gtv
Nera - Black
(R.O. 648550/1)

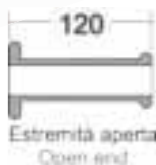

18 416 0600

PIAGGIO 125-250: Beverly Eu3 - Sport - Mic
- Rst - Tourer 07-10 • Beverly 01-03
300: Beverly Tourer Eu3 09-10
Nera - Black
(R.O. 583255/6)



18 416 0610

KIT COPERTINA COPRIMANOPOLA
GRIP COVER



18 416 0620

Coppia manopole dsh - *Dsh grips*
Nera-Rossa - *Black-Red*

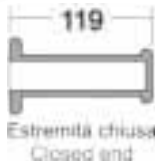

18 416 0630

Coppia manopole dsh - *Dsh grips*
Nera-Verde - *Black-Green*

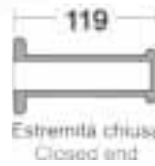

18 416 0640

Coppia manopole dsh - *Dsh grips*
Nera-Arancio - *Black-Orange*

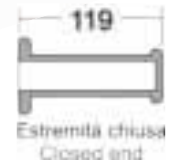

18 416 0650

Coppia manopole dsh - *Dsh grips*
Grigio-Arancio - *Grey-Orange*

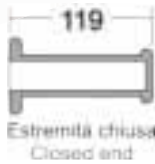

18 416 0660

Coppia manopole dsh - *Dsh grips*
Nera-Grigio - *Black-Grey*

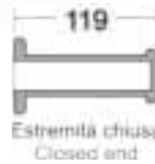

18 416 0700

HONDA 300: Sh 07-14
700: Integra 12-13
Nera - *Black*

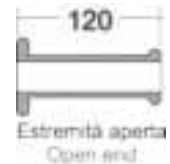

18 416 0710

Modello Retrò
Para

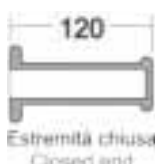

18 416 0730

Modello soft grigio - *Grey*

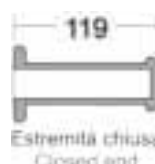

18 416 0740

Modello soft Verde - *Green*



18 416 0750



SUZUKI
Nera - *Black*

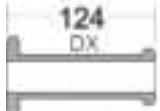

Estremità aperta
Open end

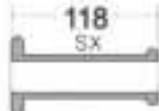

Estremità aperta
Open end

18 416 0760



Modello Desert - *Desert Model*

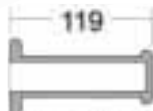

Estremità chiusa
Closed end

18 416 0770



Modello Jungle - *Jungle Model*

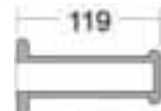

Estremità chiusa
Closed end

18 416 0780



Modello Urban - *Urban Model*

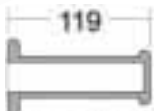

Estremità chiusa
Closed end

18 416 0720



YAMAHA SCOOTER
Nera - *Black*

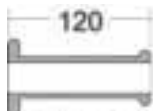

Estremità aperta
Open end

18 416 0790



Modello Snake - *Snake Model*
Giallo - Nera - *Yellow - Black*

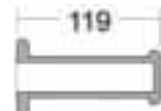

Estremità chiusa
Closed end

18 416 0800



Modello Snake - *Snake Model*
Blu - Bianco - *Blue - White*

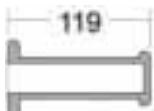

Estremità chiusa
Closed end

18 416 0810



Modello Snake - *Snake Model*
Arancio - Nera - *Orange - Black*

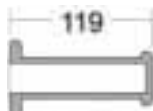

Estremità chiusa
Closed end

18 416 0820



Modello Snake - *Snake Model*
Verde - Nera - *Green - Black*

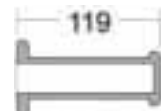

Estremità chiusa
Closed end

18 416 0830 

Modello Snake - *Snake Model*
Rosso - Nera - *Red - Black*

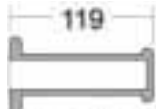

Estremità chiusa
Closed end

18 416 0900 

Modello Daytona - *Daytona Model*
Nera - *Black*

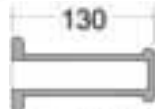

Estremità chiusa
Closed end

18 416 0910 

Modello Daytona - *Daytona Model Para*

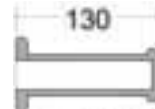

Estremità chiusa
Closed end

18 416 0930 

Modello Daytona Para - *Para Daytona Model*

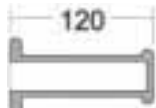

Estremità chiusa
Closed end



MANOPOLE GRIPS

18 416 0180 

"STRONG GRIP"

- Antiscivolo - *Strong Grip*
- Colore nero - *Black Color*
- Realizzate in **Pvc - Pvc Material**
- Packaging in blister - *Blister Packaging*

18 416 0280 

Come sopra ma:

- Realizzate in **Soft Pvc - Soft Pvc Material**

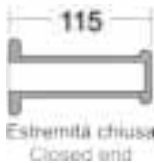

18 416 0190 

"CUSTOM"

- Elevata morbidezza - *Soft*
- Colore nero - *Black Color*
- Realizzate in **Pvc - Pvc Material**
- Packaging in blister - *Blister Packaging*

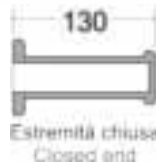

18 416 0200 

"CUSTOM" Carbon Look

- Colore Carbon - *Carbon color*
- Elevata morbidezza - *Soft*
- Realizzate in **Pvc - Pvc Material**
- Packaging in blister - *Blister Packaging*

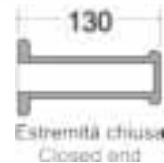

18 416 0240 

"CUSTOM" RIVESTITE

- Colore nero - *Black Color*
- Elevata morbidezza - *Soft*
- Packaging in blister - *Blister Packaging*



18 416 0210 

"AIR GRIP"

- Elevata facilità di presa - *Strong Grip*
- Colore nero - *Black Color*
- Realizzate in **Pvc - Pvc Material**
- Packaging in blister - *Blister Packaging*



18 416 0220 

"EASY GRIP"

- Colore nero - *Black Color*
- Realizzate in **Pvc - Pvc Material**
- Packaging in blister - *Blister Packaging*

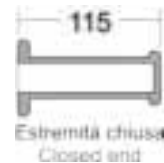

18 416 0230 

"SUPER GRIP"

- Realizzata in gomma - *Rubber*
- Elevato comfort - *High Confort*
- Colore nero - *Black Color*
- Packaging in blister - *Blister Packaging*

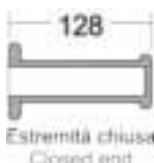

18 416 0250 

- Realizzate in **Pvc - Pvc Material**
- Colore nero - *Black Color*
- Packaging in blister - *Blister Packaging*

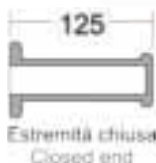

18 416 0260 

- Realizzata in gomma - *Rubber*
- Colore nero - *Black Color*
- Packaging in blister - *Blister Packaging*

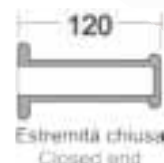



18 416 0670 

• Inserto in alluminio Silver - *Silver Alloy insert*

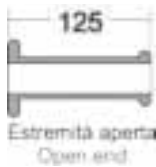

18 416 0680 

• Inserto in alluminio Rosso - *Red Alloy insert*



18 416 0690 

• Inserto in alluminio Blu - *Blue Alloy insert*

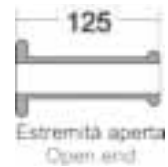

18 416 0290 

- Colore Trasparente - *Transparent Color*
- Terminale Carbon ed anelli Silver
Carbon End - Silver Rings
- Realizzate in **Pvc - Pvc Material**
- Packaging in blister - *Blister Packaging*

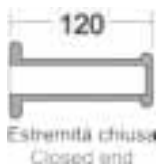

18 416 0300 

- Colore Trasparente - *Transparent Color*
- Terminale ed anelli Rosso
Red End - Red Rings
- Realizzate in **Pvc - Pvc Material**
- Packaging in blister - *Blister Packaging*

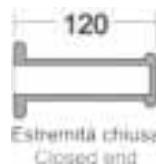

18 416 0310 

- Colore Trasparente - *Transparent Color*
- Terminale ed anelli Blu
Blue End - Blue Rings
- Realizzate in **Pvc - Pvc Material**
- Packaging in blister - *Blister Packaging*

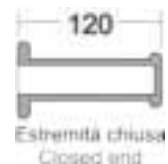

18 416 0330 

- Colore nero - *Black Color*
- Terminale ed anelli Silver
Silver End - Silver Rings
- Realizzate in **Pvc - Pvc Material**
- Packaging in blister - *Blister Packaging*

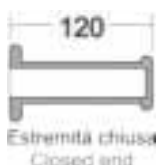

18 416 0340 

- Colore nero - *Black Color*
- Terminale ed anelli Rosso
Red End - Red Rings
- Realizzate in **Pvc - Pvc Material**
- Packaging in blister - *Blister Packaging*

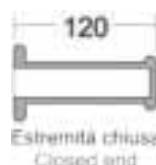

18 416 0350 

- Colore nero - *Black Color*
- Terminale ed anelli Blu
Blue End - Blue Rings
- Realizzate in **Pvc - Pvc Material**
- Packaging in blister - *Blister Packaging*

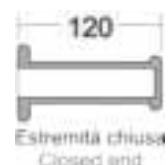



MANOPOLE GRIPS

18 416 0130 

- Spugna - *Foam grip*
- Per ciclomotori Ciao e Vespa - *Moped*
- Tipo orig. Nere - *Black*

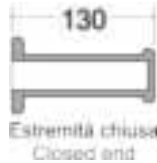

18 416 0090 

- Ø 24/24
- PIAGGIO:** Vespa 50 Pk • Pk XL
- Tipo orig. Nere - *Black*
- (R.O.227077)

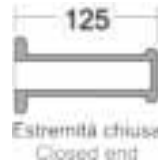

18 416 0100 

- Ø 24/24
- PIAGGIO:** Vespa 50 • 125 Et3
- Tipo orig. Nere - *Black*
- (R.O.141924)

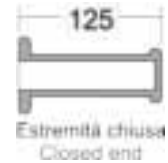

18 416 0110 

- Ø 24/24
- PIAGGIO:** Vespa Px - Pe
- Tipo orig. Nere - *Black*
- (R.O.141923)

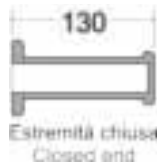

18 416 0120 

- Ø 22/22
- PIAGGIO:** Px Arcobaleno 125-150-200
- Tipo orig. Nere - *Black*
- (R.O.179833)



18 416 0390 

- PIAGGIO:** Vespa Px Fd
- (R.O. 582234)

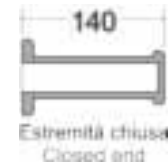

18 416 0140 

- Ø 24/24
- PIAGGIO:** Vespa Px Pe VNX - VLX - VSX
- Colore grigio - *Gray color*

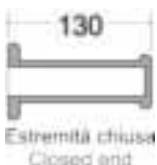

18 416 0550 

- Ø 24/24
- PIAGGIO:** Vespa 50-90-125 Primavera
- V5A2T - V5B1T - VMA2 - V9A1
- Colore grigio - *Gray color*

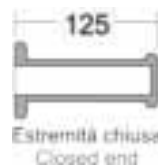

18 416 0560 

- Ø 24/24
- PIAGGIO:** Vespa 50 Pk-Pk-Rush-N XL
- 125 Pk-Pk XL
- VA52T-V5X3T-VMX6T-V5X5T-V5X4T
- (R.O. 248317)

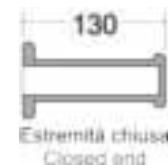



18 416 0270 

- Design Ergonomic - *High Confort*
- Realizzate in **Pvc - Pvc Material**
- Colore nero - *Black Color*
- Packaging in blister - *Blister Packaging*

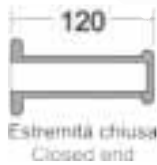

18 416 0840 

- Vintage Nere 125mm
125 mm Vintage Black Grips

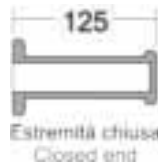

18 416 0850 

- Vintage Marroni 125 mm
125 mm Vintage Brown Grips

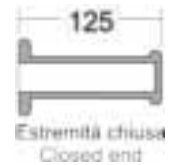

18 416 0860 

- Vintage Cafe 125 mm
125 mm Vintage Cafe Grips

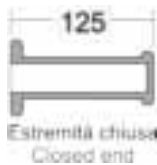

18 416 0870 

- Vintage Nere 115 mm
115 mm Vintage Black Grips

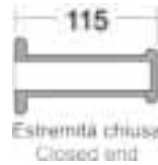

18 416 0880 

- Vintage Marroni 115 mm
115 mm Vintage Brown Grips

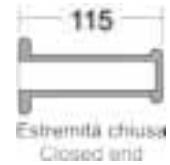

18 416 0890 

- Vintage Cafe 115 mm
115 mm Vintage Cafe Grips

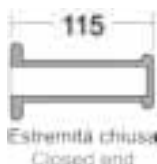



RMS

YOUR BEST PARTNER

▶ TRASMISSIONE SCOOTER

SCOOTER TRANSMISSION



TRASMISSIONI CONTACHILOMETRI SPEEDOMETER TRANSMISSIONS

CC	MODELLO MODEL	ANNI YEARS	CONTACHILOMETRI SPEEDOMETER	CC	MODELLO MODEL	ANNI YEARS	CONTACHILOMETRI SPEEDOMETER
APRILIA				125	Leonardo St	01-04	16 363 0110 (AP8114357)
50	Amico (Freno a Disco - Disc Brake)	94	16 363 0030 (AP8214110)	125	Mojito	03-07	16 363 1350 (AP8114472)
50	Amico (Freno a Tamburo- Brake Drum)	94	16 363 0020 (AP8214169)	125	Mojito	08	16 363 1350 (AP8114472)
50	Amico GI-Gle (Freno a Disco - Disc Brake)	93-95	16 363 0030 (AP8214110)	125	Mojito - Custom	99-01	16 363 1350 (AP8214194)
50	Amico GI-Gle (Freno a Tamburo- Brake Drum)	93-95	16 363 0020 (AP8214169)	125	Mojito Retro'	99-01	16 363 1360 (AP8214186)
50	Amico Lx- Sport-Cat (Freno a Disco - Disc Brake)	92-93	16 363 0030 (AP8214110)	125	Scarabeo	03	16 363 0110 (AP8114357)
50	Gulliver	95-98	16 363 0060 (AP8214142)	125	Scarabeo	04-06	16 363 0110 (AP8114357)
50	Gulliver Lc	96-98	16 363 0060 (AP8214142)	125	Scarabeo Motore Piaggio Eu3	06	16 363 0110 (AP8114357)
50	Mojito Custom	99-03	16 363 1350 (AP8214194)	125	Scarabeo Motore Rotax	99-04	16 363 0110 (AP8114357)
50	Mojito Custom 2T Motore Piaggio	04-10	16 363 1350 (AP8114472)	125	Sr	99-01	16 363 0090 (AP8214163)
50	Mojito Retro	99-03	16 363 1360 (AP8214186)	BENELLI			
50	Rally Liquid Cooled	96-99	16 363 0080 (AP8214165)	50	491 Gt	98-99	16 363 1200 (R53410011A0)
50	Scarabeo	93-97	16 363 0070 (AP8214126)	50	491 Racing	98-99	16 363 1200 (R53410011A0)
50	Scarabeo	98	16 363 0070 (AP8214126)	50	491 Rr	99-01	16 363 1200 (R53410011A0)
50	Scarabeo	99	16 363 0070 (AP8214126)	50	491Sp	99	16 363 1200 (R53410011A0)
50	Scarabeo	00-05	16 363 0070 (AP8214126)	50	491 Sport	98-99	16 363 1200 (R53410011A0)
50	Scarabeo Street	05-06	16 363 0070 (AP8214126)	50	491 St	99-01	16 363 1200 (R53410011A0)
50	Scarabeo Street 2T Restyling	06-09	16 363 0070 (AP8214126)	50	491 Rr Morini	03-04	16 363 1190 (R53410021A0)
50	Sonic	98-07	16 363 0100 (AP8214173)	50	491 St Morini	03	16 363 1190 (R53410021A0)
50	Sonic Gp	98-08	16 363 0100 (AP8214173)	50	K2 Liquid Cooled	98-01	16 363 1190 (R53410021A0)
50	Sr	93	16 363 0050 (AP8214130)	50	K2	98-01	16 363 1190 (R53410021A0)
50	Sr	94-96	16 363 0060 (AP8214142)	50	K2	99-01	16 363 1190 (R53410021A0)
50	Sr Ditech Euro 2	02-04	16 363 0090 (AP8214163)	BETA			
50	Sr H2o Ditech E Carburatore	00-04	16 363 0090 (AP8214163)	50	Eikon	-	16 363 1210 (2914221052)
50	Sr Liquid Cooled	94-96	16 363 0060 (AP8214142)	50	Ark Lc	-	16 363 1220 (2914220052)
50	Sr Stealth, Racing	97-00	16 363 0090 (AP8214163)	DERBI			
50	Sr Street	03-12	16 363 0090 (AP8214163)	50	Atlantis	99-00	16 363 1520 (00G01605021)
50	Sr Www	97-01	16 363 0090 (AP8214163)	50	Atlantis	01	16 363 1520 (00G01605021)
125	Leonardo	96-98	16 363 0110 (AP8114357)	50	Atlantis 2T	10	16 363 1520 (00G01605021)
125	Leonardo	99-02	16 363 0110 (AP8114357)	50	Atlantis 2T Eu2	07-09	16 363 1520 (00G01605021)
				50	Atlantis 4T Eu2	07	16 363 1520 (00G01605021)

TRASMISSIONI CONTACHILOMETRI

SPEEDOMETER TRANSMISSIONS



CC	MODELLO MODEL	ANNI YEARS	CONTACHILOMETRI SPEEDOMETER	CC	MODELLO MODEL	ANNI YEARS	CONTACHILOMETRI SPEEDOMETER
50	Atlantis 50-100 4T	04-06	16 363 1520 (00G01605021)	125	Runner Vx-Vxr 125-200	02-04	16 363 1690 (582413)
50	Atlantis Lc	99-01	16 363 1520 (00G01605021)	125	Typhoon	95-98	16 363 0180 (563621)
50	Atlantis O2	02	16 363 1520 (00G01605021)	125	Typhoon X-Xr	99-00	16 363 0180 (563621)
50	Atlantis O2 Bullet	03-05	16 363 1520 (00G01605021)	HONDA			
50	Atlantis O2 City	03-06	16 363 1520 (00G01605021)	50	Bali	93-96	16 363 0290 (44830-GAV-700)
50	Atlantis O2 Red Bullet	03	16 363 1520 (00G01605021)	50	Sfx	97-99	16 363 0300 (44830-GBM-750)
50	Atlantis O2 Two Chic	05	16 363 1520 (00G01605021)	50	Sh	85-95	16 363 0290 (44830-GJ3-600)
50	Gp1	01-02	16 363 1600 (00G01606021)	50	Sh	96>	16 363 1230 (44830-GBJ-910)
50	Gp1	03	16 363 1600 (00G01606021)	50	Sky	99-01	16 363 0310 (44830-GCG-930)
50	Gp1 E2	03	16 363 1600 (00G01606021)	50	Vision	-	16 363 0320 (44830-GN2-030)
50	Predator Lc	98-01	16 363 1600 (00G01604021)	100	Bali	96-98	16 363 0290 (44830-GAV-700)
50	Predator O2	98-01	16 363 1600 (00G01604021)	125	Chiocciola	02-10	16 363 1490 (44830-KGF-900)
50	Senda R	00-01	16 363 1590 (00H01612021)	125	Sh	-	16 363 1530 (44830-KPR-900)
50	Senda Sm	00-01	16 363 1590 (00H01612021)	150	Chiocciola	02-10	16 363 1490 (44830-KGF-900)
100	Atlantis	00-01	16 363 1520 (00G01605021)	150	Sh	-	16 363 1530 (44830-KPR-900)
GILERA				250	Foresight	98	16 363 0240 (44830-KFG-000)
50	Easy Moving	95-96	16 363 0190 (574331)	250	Jazz	01-04	16 363 1500 (44830-KS4-010)
50	Runner	97-00	16 363 0220 (561710)	ITALJET			
50	Stalker	97-04	16 363 0210 (561152)	50	Formula	-	16 363 0380
50	Stalker	05-06	16 363 0210 (561152)	KYMCO			
50	Stalker	07-08	16 363 0210 (561152)	50	Agility 2T R16	10	16 363 1720 (00151323)
50	Stalker	09-11	16 363 0210 (561152)	50	Agility 2T R16	12	16 363 1720 (00151323)
50	Stalker Special Edition	07-08	16 363 0210 (561152)	50	Agility 4T Carry	11	16 363 1710 (00151080)
50	Storm	94-95	16 363 0180 (563621)	50	Agility 4T R10	06	16 363 1700 (00151100)
50	Typhoon (Dal-From Tec1t 0065089)	94-97	16 363 0180 (563621)	50	Agility 4T R10	07-08	16 363 1700 (00151100)
50	Typhoon (Fino Al - Till Tec1t 0065088)	94-97	16 363 0200 (272353)	50	Agility 4T R12	07-08	16 363 1710 (00151080)
50	Typhoon X	98-99	16 363 0180 (563621)	50	Agility 4T R16	08	16 363 1720 (00151323)
50	Typhoon Xr	00	16 363 0180 (563621)	50	Agility 4T R16	09	16 363 1720 (00151323)
125	Runner Fx-Fxr 125-180	97-02	16 363 1240 (563412)	50	Agility 4T R16	12	16 363 1720 (00151323)
125	Runner Vx-Vxr 125-180	00-01	16 363 1690 (582413)	50	Agility Plus 2T	14	16 363 1720 (00151323)
				50	Agility Plus 4T	14	16 363 1720 (00151323)



TRASMISSIONI CONTACHILOMETRI SPEEDOMETER TRANSMISSIONS

CC	MODELLO MODEL	ANNI YEARS	CONTACHILOMETRI SPEEDOMETER	CC	MODELLO MODEL	ANNI YEARS	CONTACHILOMETRI SPEEDOMETER
50	Agility R12	05	16 363 1710 (00151080)	125	Dink Classic 125-150	02	16 363 1420 (00151914)
50	Dink Classic Eu2	03	16 363 1420 (00151914)	125	Dink Classic 125-150 Eu2	03	16 363 1420 (00151914)
50	Dink Lc	98-02	16 363 1420 (00151914)	125	Dink Lx 125-150	98-00	16 363 1420 (00151914)
50	Heroism	95-97	16 363 0680 (44830-KLF-9010 00151720)	125	Grand Dink 125-150	01-02	16 363 1570 (00151171)
50	Like 2T	09	16 363 1710 (00151080)	125	Grand Dink 125-150 Eu2	03-04	16 363 1570 (00151171)
50	Like 4T	09	16 363 1710 (00151080)	125	Heroism	95-97	16 363 0680 (44830-KLF-9010 00151720)
50	People	99-00	16 363 1430 (00151303)	125	Like	09	16 363 1710 (00151080)
50	People	04	16 363 1430 (00151303)	125	Like Lx	12	16 363 1710 (00151080)
50	People Eu2	03	16 363 1430 (00151303)	125	Movie	99-00	16 363 1440 (00151117)
50	People Eu2	08	16 363 1430 (00151303)	125	People 125-150	99-00	16 363 1430 (00151303)
50	People Eu2	11	16 363 1430 (00151303)	125	People 125-150 Eu2	03	16 363 1430 (00151303)
50	People S	05-08	16 363 1720 (00151323)	125	People Euro3	07	16 363 1430 (00151303)
50	People S 4T	06-08	16 363 1720 (00151323)	125	People Euro3	08	16 363 1430 (00151303)
50	Super 8	07	16 363 1720 (00151323)	125	People Euro3	11	16 363 1430 (00151303)
50	Super 8 2T	09	16 363 1720 (00151323)	125	People S	05	16 363 1720 (00151323)
50	Super 8 2T	13	16 363 1720 (00151323)	125	People S Dd Euro3	07-08	16 363 1720 (00151323)
50	Super 8 4T	09	16 363 1720 (00151323)	125	Super 8	08	16 363 1720 (00151323)
50	Super 8 4T	13	16 363 1720 (00151323)	125	Super 8	09	16 363 1720 (00151323)
50	Super 9	00	16 363 1540 (00151310)	125	Vivio 125-150	00	16 363 1440 (00151117)
50	Super 9 Sport Eu2	03	16 363 1540 (00151310)	150	Agility R16	08	16 363 1720 (00151323)
50	Super 9 Sport Eu2	04	16 363 1540 (00151310)	150	Agility R16	09	16 363 1720 (00151323)
125	Agility 4T	06	16 363 1710 (00151080)	150	Heroism	95-97	16 363 0680 (44830-KLF-9010 00151720)
125	Agility 4T Euro3	06-08	16 363 1710 (00151080)	200	Agility 200l R16	10	16 363 1720 (00151323)
125	Agility Carry	11	16 363 1710 (00151080)	200	Agility l Plus	14	16 363 1720 (00151323)
125	Agility Plus	14	16 363 1720 (00151323)	200	Agility R16	12	16 363 1720 (00151323)
125	Agility R16	08	16 363 1720 (00151323)	200	Dink Classic	04	16 363 1420 (00151914)
125	Agility R16	09	16 363 1720 (00151323)	200	Like 200l	09	16 363 1710 (00151080)
125	Agility R16	12	16 363 1720 (00151323)	200	Like Lx	12	16 363 1710 (00151080)
125	Dink 125-150	97-98	16 363 1420 (00151914)				

TRASMISSIONI CONTACHILOMETRI

SPEEDOMETER TRANSMISSIONS



CC	MODELLO MODEL	ANNI YEARS	CONTACHILOMETRI SPEEDOMETER	CC	MODELLO MODEL	ANNI YEARS	CONTACHILOMETRI SPEEDOMETER
200	People S	05	16 363 1720 (00151323)	50	F12 Aria Restyling Euro 2	06	16 363 0440 (17813300)
200	People S 200I	07	16 363 1720 (00151323)	50	F12 Phantom	94-98	16 363 0470 (17809400)
250	B&W Eu2	03	16 363 1570 (00151171)	50	F12 Phantom Euro1	99-00	16 363 0440 (17813300)
250	Grand Dink	01-02	16 363 1570 (00151171)	50	F12 Phantom Lc	94-98	16 363 0470 (17809400)
250	People Lc	03-04	16 363 1730 (00156398)	50	F12 Phantom Lc Euro1	99-00	16 363 0440 (17813300)
250	People S	06	16 363 1730 (00156398)	50	F12 Phantom Lc Restyling Eu1	01-02	16 363 0440 (17813300)
250	Venox	02-03	16 363 1740 (00152059)	50	F12 Phantom Lc Restyling Eu2	02	16 363 0440 (17813300)
250	Venox Eu2	04	16 363 1740 (00152059)	50	F12 Phantom Lc Restyling Eu2-2.3	03-04	16 363 0440 (17813300)
250	Venox Euro3	07	16 363 1740 (00152059)	50	F12 Phantom Lc Twin Disks	98	16 363 0470 (17809400)
300	People S 300I	08	16 363 1730 (00156398)	50	F15 Fire Fox	96-98	16 363 0400 (17811400)
MALAGUTI				50	F15 Fire Fox Air Cooled	05-06	16 363 0440 (17813300)
50	Centro SL	94-98	16 363 0450 (17808900)	50	F15 Fire Fox Twin Disks & Special	98-99	16 363 0400 (17811400)
50	Centro SL Kat	99-00	16 363 0450 (17808900)	100	Ciak	99-00	16 363 0510 (17814400)
50	Ciak	99-00	16 363 0510 (17814400)	100	F12 Phantom	99-00	16 363 0440 (17813300)
50	Ciak Master	04	16 363 0510 (17814400)	125	Ciak	00-01	16 363 0510 (17814400)
50	Ciak Master 4T	05-06	16 363 0510 (17814400)	125	Ciak Master	04	16 363 0510 (17814400)
50	Ciak Master Euro 2	06	16 363 0510 (17814400)	125	Ciak Master Euro 3	06	16 363 0510 (17814400)
50	Ciak Mono Euro 2	03	16 363 0510 (17814400)	125	Ciak Restyling Eu2	03	16 363 0510 (17814400)
50	Ciak Mono Euro 2 2.3	03	16 363 0510 (17814400)	125	Madison	99-01	16 363 0500 (17814300)
50	Ciak Td	00-01	16 363 0510 (17814400)	125	Madison R Restyling	02	16 363 0500 (17814300)
50	Crosser Cr1	95-98	16 363 0480 (17810700)	125	Madison R Restyling Eu2	03-04	16 363 0500 (17814300)
50	F10 Ac	08	16 363 0430 (17811600)	150	Ciak	00-02	16 363 0510 (17814400)
50	F10 Ac Eco	09-10	16 363 0430 (17811600)	150	Ciak Master	04	16 363 0510 (17814400)
50	F10 Jet Line (Modelli V/W)	98	16 363 0430 (17811600)	150	Ciak Restyling Eu2	03	16 363 0510 (17814400)
50	F10 Jet Line (Modelli N/P/R/S/T)	92-97	16 363 0460 (17808100)	150	Madison T	99-01	16 363 0500 (17814300)
50	F10 Kat	99-00	16 363 0430 (17811600)	200	Ciak Master Euro 2	06	16 363 0510 (17814400)
50	F10 Restyling Eu1	01-02	16 363 0430 (17811600)	MBK			
50	F10 Restyling Eu2-2.3	03-04	16 363 0430 (17811600)	50	Cw Booster	90-91	16 363 0540 (3VLH35500000)
50	F10 Restyling Eu2	02-03	16 363 0430 (17811600)	50	Cw Booster	01-02	16 363 1280 (4PAH35500200)
50	F10 Restyling Eu2	06	16 363 0430 (17811600)	50	Cw Booster (ITA)	92-94	16 363 0540 (3VLH35500000)



TRASMISSIONI CONTACHILOMETRI SPEEDOMETER TRANSMISSIONS

CC	MODELLO MODEL	ANNI YEARS	CONTACHILOMETRI SPEEDOMETER	CC	MODELLO MODEL	ANNI YEARS	CONTACHILOMETRI SPEEDOMETER
50	Cw Booster Spirit	96-98	16 363 1280 (4PAH35500200)	100	Yq Ni Tro (5Me7)	00-02	16 363 1140 (5PUH35500200)
50	Cw Booster Spirit (ITA)	99	16 363 1280 (4PAH35500200)	100	Yq Ni Tro (5Me2 -5Me5)	00-02	16 363 0520 (5BRH35500200)
50	Cw Booster Spirit (ITA)	00	16 363 1280 (4PAH35500200)	100	Yw Booster	99-01	16 363 1290 (4VPH35500100)
50	Cw Booster Spirit Eu2	02	16 363 1280 (4PAH35500200)	125	Yp Skyli Ner	98-00	16 363 1340 (5DSH35500000)
50	Cw Booster Spirit Eu2	03	16 363 1280 (4PAH35500200)	150	Yp Skyli Ner	00	16 363 1340 (5DSH35500000)
50	Cw L Booster	01-03	16 363 1280 (4PAH35500200)	PEUGEOT			
50	Cw L Booster Spirit	03	16 363 1280 (4PAH35500200)	50	Buxi	-	16 363 0740 (732615)
50	Cw R Booster Road (ITA)	94-95	16 363 1280 (4PAH35500200)	50	Elise	-	16 363 0790 (740993)
50	Cw Rs Booster Ng	01-02	16 363 1270 (4SBH35500300)	50	Geo	-	16 363 0730 (724335)
50	Cw Rs Booster Ng	03	16 363 1270 (4SBH35500300)	50	Ludix 10	-	16 363 1660 (762744)
50	Cw Rs Booster Ng (ITA)	95-98	16 363 1270 (4SBH35500300)	50	Ludix 14	-	16 363 1670 (762745)
50	Cw Rs Booster Ng (ITA)	99	16 363 1270 (4SBH35500300)	50	Speedake	-	16 363 0740 (732615)
50	Cw Rs Booster Ng Euro1	99-00	16 363 1270 (4SBH35500300)	50	Speedfight	-	16 363 0770 (736610)
50	Cw Rsp Booster Rocket (ITA)	97-98	16 363 1270 (4SBH35500300)	50	Trekker	-	16 363 0800 (736721)
50	Cw Sp Booster Spirit Eu2	02	16 363 1280 (4PAH35500200)	50	Viva City	-	16 363 0810 (739602)
50	Ew Stunt	00-02	16 363 1270 (4SBH35500300)	50	Zenith (Freno Tamburo/Drum)	-	16 363 0760
50	Ya R Forte (Che- ITA)	94-96	16 363 0610 (4PCH3550000)	125	Sv	-	16 363 0730 (724335)
50	Yh Flipper	98	16 363 0620 (5EUH35500000)	PGO			
50	Yh Flipper	01-02	16 363 0620 (5EUH35500000)	50	Big Max	-	16 363 0820 (1544001000)
50	Yh Flipper Catalitico	99-00	16 363 0620 (5EUH35500000)	PIAGGIO			
50	Yh Flipper Eu2	03-04	16 363 0620 (5EUH35500000)	50	Boss	88-89	16 363 0990 (187423)
50	Ym Fizz (ITA)	94-95	16 363 1280 (4PAH35500200)	50	Ciao	80-88	16 363 0990 (187423)
50	Yq L Ni Tro Jaguar	04	16 363 1140 (5PUH35500100)	50	Fly 2T	05-07	16 363 1650 (600315)
50	Yq Ni Tro (5Pe2-5Pe4)	01-02	16 363 0520 (5BRH35500200)	50	Fly 2T	10-11	16 363 1650 (600315)
50	Yq Ni Tro (5Pe6)	01-02	16 363 1140 (5PUH35500200)	50	Fly 4T	05-07	16 363 1650 (600315)
50	Yq Ni Tro	04	16 363 0520 (5BRH35500200)	50	Fly 4T & 25-30 Km/H	08-11	16 363 1650 (600315)
50	Yq Ni Tro (ITA)	97-98	16 363 0520 (5BRH35500200)	50	Fly 4T Motore Chn	06-07	16 363 1650 (600315)
50	Yq Ni Tro (ITA)	99-00	16 363 0520 (5BRH35500200)	50	Free	92-94	16 363 0950 (272352)
50	Yq Ni Tro Eu2	03	16 363 1140 (5PUH35500100)	50	Free Delivery	00-01	16 363 1580 (582414)
				50	Free Fl	95-02	16 363 0950 (272352)
				50	Grillo	89-93	16 363 0990 (187423)

TRASMISSIONI CONTACHILOMETRI

SPEEDOMETER TRANSMISSIONS



CC	MODELLO MODEL	ANNI YEARS	CONTACHILOMETRI SPEEDOMETER	CC	MODELLO MODEL	ANNI YEARS	CONTACHILOMETRI SPEEDOMETER
50	Liberty	97-05	16 363 0960 (560973)	50	Vespa Lx 4T-4V	09-13	16 363 2110 (649347)
50	Liberty 2T	06	16 363 1640 (647804)	50	Vespa Lx 4T-4V Touring	10-13	16 363 2110 (649347)
50	Liberty 2T	07-08	16 363 1640 (647804)	50	Vespa Lxv 2T	06-09	16 363 2080 (650838)
50	Liberty 4T	00-02	16 363 0960 (560973)	50	Vespa Lxv 2T Navy	08	16 363 2080 (650838)
50	Liberty 4T	05-08	16 363 1640 (647804)	50	Vespa S 2T & College	07-12	16 363 2060 (650836)
50	Liberty 4T Delivery - Single	10-14	16 363 1640 (647804)	50	Vespa S 4T-4V & College	08-12	16 363 2060 (650836)
50	Liberty 4T Ptt (Deu)	07-12	16 363 1630 (647803)	50	Zip	92-93	16 363 0190 (574331)
50	Liberty Moc 2T & Elle	09-13	16 363 1640 (647804)	50	Zip	95-96	16 363 0190 (574331)
50	Liberty Moc 4T & Elle	09-13	16 363 1640 (647804)	50	Zip	00-04	16 363 1300 (581321)
50	Nrg	94-96	16 363 0180 (563621)	50	Zip 2T	08-13	16 363 1300 (581321)
50	Nrg Extreme	99-00	16 363 0970 (581287)	50	Zip 4T	00-05	16 363 1300 (581321)
50	Nrg Mc3	01-04	16 363 0970 (581287)	50	Zip 4T	06-13	16 363 1300 (581321)
50	Nrg Purejet	02-04	16 363 0970 (581287)	50	Zip Bimodale	94-97	16 363 0190 (574331)
50	Nrg Rst Mc2	96-98	16 363 0180 (563621)	50	Zip Fast Raider	93-94	16 363 0190 (574331)
50	Ntt	95-96	16 363 0180 (563621)	50	Zip Fast Raider Rst	96-97	16 363 0920 (581682)
50	Quartz	92-96	16 363 0890 (268263)	50	Zip Rst	96-99	16 363 0920 (581682)
50	Sfera Maquillage 2	94	16 363 0870 (266848)	50	Zip Sp	96-00	16 363 0930 (582507)
50	Sfera	91-93	16 363 0870 (266848)	50	Zip Sp	01-04	16 363 0930 (582507)
50	Sfera Rst	95-97	16 363 0880 (562403)	50	Zip Sp Eu2	06-13	16 363 0930 (649335)
50	Typhoon	01-04	16 363 0180 (563621)	80	Skr City	99	16 363 0870 (266848)
50	Typhoon 2T Eu2	10-12	16 363 2050 (858542)	100	Fly 4T	06-07	16 363 1650 (600315)
50	Typhoon 2T Euro3 Ch	11	16 363 2050 (858542)	100	Fly 4T	08	16 363 1650 (600315)
50	Vespa Et2	97-05	16 363 1020 (56116R)	100	Zip 4T	06-10	16 363 1300 (581321)
50	Vespa Et2 Iniezione	97-00	16 363 1020 (56116R)	125	Beverly Euro 3	07-08	16 363 1620 (648992)
50	Vespa Et4	00-05	16 363 1020 (56116R)	125	Beverly Euro 3 Mic	07	16 363 1620 (648992)
50	Vespa Lx 2T	05-08	16 363 2110 (649347)	125	Beverly Euro 3 Sport	07-08	16 363 1620 (648992)
50	Vespa Lx 2T	09-13	16 363 2110 (649347)	125	Beverly Rst	04-05	16 363 1620 (599866)
50	Vespa Lx 2T Touring & 30Km	10-13	16 363 2110 (649347)	125	Beverly Rst	05-07	16 363 1620 (648992)
50	Vespa Lx 4T	05-08	16 363 2110 (649347)	125	Beverly Tourer Euro3	07-10	16 363 1620 (648992)



TRASMISSIONI CONTACHILOMETRI SPEEDOMETER TRANSMISSIONS

CC	MODELLO MODEL	ANNI YEARS	CONTACHILOMETRI SPEEDOMETER	CC	MODELLO MODEL	ANNI YEARS	CONTACHILOMETRI SPEEDOMETER
125	Carnaby	07-10	16 363 1780 (648929)	125	Vespa Lx 4T Euro3 Touring	10-11	16 363 2110 (649347)
125	Fly	05-07	16 363 1650 (600315)	125	Vespa Lx 4T FL	09	16 363 2110 (649347)
125	Fly Euro3	07	16 363 1650 (600315)	125	Vespa Lx Euro 3	06-08	16 363 2110 (649347)
125	Fly Euro3	08-11	16 363 1650 (600315)	125	Vespa Lx Euro 3 le	09-11	16 363 2110 (649347)
125	Hexagon	94-97	16 363 0980 (274643)	125	Vespa Lxv 4T Euro3	06-09	16 363 2080 (650838)
125	Hexagon Gtx	00	16 363 1090 (561279)	125	Vespa Lxv 4T Navy Euro3	07-08	16 363 2080 (650838)
125	Hexagon Lx4	98-99	16 363 1090 (561279)	125	Vespa Lxv le 4T	10-13	16 363 2080 (650838)
125	Hexagon Lx-Lxt	98-99	16 363 1090 (561279)	125	Vespa S 4T 3V le	12	16 363 2060 (650836)
125	Liberty	98-00	16 363 0960 (560973)	125	Vespa S 4T Euro 3	07-08	16 363 2060 (650836)
125	Liberty	01-02	16 363 0960 (560973)	125	X8	05-06	16 363 1790 (648572)
125	Liberty 4T	06-07	16 363 1630 (647803)	125	X8 Premium Euro 2	06	16 363 1790 (648572)
125	Liberty 4T Euro3	06-08	16 363 1630 (647803)	125	X8 Premium Euro 3	06-07	16 363 1790 (648572)
125	Liberty 4T Euro3 Delivery - Single	07-15	16 363 1630 (647803)	125	X8 Street Euro 2	06-07	16 363 1790 (648572)
125	Liberty 4T Euro3 Delivery - Tnt	08-09	16 363 1630 (647803)	125	Zip	00-02	16 363 0930 (582507)
125	Liberty Rst Ptt	05-11	16 363 1630 (647803)	150	Fly	05-07	16 363 1650 (600315)
125	Sfera	95-97	16 363 0880 (562403)	150	Fly Euro3	08-11	16 363 1650 (600315)
125	Skipper	94-97	16 363 0890 (268263)	150	Liberty 4T Euro3	08	16 363 1630 (647803)
125	Typhoon 4T 2V Euro3	10-11	16 363 2050 (858542)	150	Vespa Gts Super le 4T 3V	14	16 363 2090 (650849)
125	Vespa Et4	96-98	16 363 1020 (56116R)	150	Vespa Lx	05-06	16 363 2110 (649347)
125	Vespa Et4	99-02	16 363 1020 (56116R)	150	Vespa Lx 4T 3V le - Touring	12-13	16 363 2110 (649347)
125	Vespa Granturismo	03-05	16 363 2100 (651072)	150	Vespa Lx 4T FL	09	16 363 2110 (649347)
125	Vespa Granturismo	06-07	16 363 2100 (651072)	150	Vespa Lx Euro 3	06-08	16 363 2110 (649347)
125	Vespa Granturismo Euro 3	06-07	16 363 1610 (599350)	150	Vespa Lx Euro 3 le	09-11	16 363 2110 (649347)
125	Vespa Gts 4T le Super	09-15	16 363 2090 (650849)	150	Vespa Lx Touring	10-12	16 363 2110 (649347)
125	Vespa Gts Euro3	07-12	16 363 1610 (599350)	150	Vespa S 4T	08-09	16 363 2060 (650836)
125	Vespa Gtv	06-08	16 363 2070 (650837)	150	Vespa S 4T le & College	09-12	16 363 2060 (650836)
125	Vespa Gtv 4T Navy Euro3	08	16 363 2070 (650837)	200	Carnaby	07-08	16 363 1780 (648929)
125	Vespa Lx	05-06	16 363 2110 (649347)	200	Liberty	06	16 363 1630 (647803)
125	Vespa Lx 4T 3V le - Touring	12-13	16 363 2110 (649347)	200	Liberty Rst	04	16 363 1630 (647803)

TRASMISSIONI CONTACHILOMETRI

SPEEDOMETER TRANSMISSIONS



CC	MODELLO MODEL	ANNI YEARS	CONTACHILOMETRI SPEEDOMETER	CC	MODELLO MODEL	ANNI YEARS	CONTACHILOMETRI SPEEDOMETER
200	Vespa Granturismo	06-07	16 363 2100 (651072)	SUZUKI			
200	X8	05-07	16 363 1790 (648572)	50	Ay A K5-K6	05-06	16 363 1160 (34910-35E00-000)
250	Beverly	06-07	16 363 1620 (648992)	50	Ay Ayw K1-K4	01-04	16 363 1160 (34910-35E00-000)
250	Beverly Euro 3 Mic	07	16 363 1620 (648992)	50	Ay Ayw Katana V-Y	97-00	16 363 1160 (34910-35E00-000)
250	Beverly Rst	04-05	16 363 1620 (599866)	SYM			
250	Beverly Tourer Euro3	07-09	16 363 1620 (648992)	50	Dd	02	16 363 1810 (44830T47000)
250	Carnaby	08	16 363 1780 (648929)	50	Dd Eu2	03-07	16 363 1810 (44830T47000)
250	Hexagon Gt-Gtx	98-00	16 363 1090 (561279)	50	Fiddle Iii	14	16 363 1880 (44830ABA000)
250	Vespa Gt 60 Euro 3	06-07	16 363 2070 (650837)	50	Jet	99	16 363 1840 (44830E69000)
250	Vespa Gts	05-14	16 363 2090 (650849)	50	Jet	00-01	16 363 1840 (44830E69000)
250	Vespa Gts Abs	05-12	16 363 2090 (601321)	50	Jet Euro X Eu2	03-07	16 363 1840 (44830E69000)
250	Vespa Gtv	06-09	16 363 2070 (650837)	50	Jet4	09-10	16 363 1880 (44830ABA000)
250	Vespa Gtv 4T Navy Euro3	07	16 363 2070 (650837)	50	Jet4 R 2T	11	16 363 1880 (44830ABA000)
250	X8 Euro3	05-08	16 363 1790 (648572)	50	Jet4 R 2T	12-14	16 363 1880 (44830ABA000)
300	Carnaby Cruiser	09-12	16 363 2010 (650950)	50	Jungle	99	16 363 1840 (44830E69000)
300	Vespa Gts Ie & Touring	12-14	16 363 2090 (650849)	50	Jungle	00	16 363 1840 (44830E69000)
300	Vespa Gts Ie Touring	11-12	16 363 2090 (650849)	50	Mask	00-01	16 363 1840 (44830E69000)
300	Vespa Gts Super	08-14	16 363 2090 (650849)	50	Mask Eu2	03-04	16 363 1840 (44830E69000)
300	Vespa Gts Super Sport	10-13	16 363 2090 (650849)	50	Mio	06-07	16 363 1810 (44830T47000)
300	Vespa Gtv 4T 4V Ie	10-13	16 363 2070 (650837)	50	Mio	09	16 363 1810 (44830T47000)
300	Vespa Gtv Via Montenapoleone	10	16 363 2070 (650837)	50	Red Devil	99	16 363 1840 (44830E69000)
400	Beverly Euro 3	06-07	16 363 1770 (599685)	50	Simply Ii	14	16 363 1880 (44830ABA000)
400	Beverly Tourer Euro3	08-10	16 363 1770 (599685)	50	Super Fancy	98-00	16 363 1800 (44830H09000)
400	X8 Euro3	06-08	16 363 1790 (648572)	50	Symply	07-08	16 363 1880 (44830ABA000)
500	Beverly	02-04	16 363 1770 (599685)	50	Symply Ii	09	16 363 1880 (44830ABA000)
500	Beverly	05-06	16 363 1770 (599685)	50	X Pro	13	16 363 1880 (44830ABA000)
500	Beverly Cruiser	07-12	16 363 2020 (649268)	100	Jet	99-00	16 363 1840 (44830E69000)
500	Beverly Euro 3	06-08	16 363 1770 (599685)	100	Mio Eu2	05-06	16 363 1810 (44830T47000)
SCOOTER CINESI				100	Mio Euro3	07-08	16 363 1810 (44830T47000)
50	Gy6	-	16 363 2030	125	Attila	99-00	16 363 1840 (44830M91000)



TRASMISSIONI CONTACHILOMETRI SPEEDOMETER TRANSMISSIONS

CC	MODELLO MODEL	ANNI YEARS	CONTACHILOMETRI SPEEDOMETER	CC	MODELLO MODEL	ANNI YEARS	CONTACHILOMETRI SPEEDOMETER
125	Euro Mx	02	16 363 1860 (44830H3A600)	150	Vs	06	16 363 1830 (44830VS1100)
125	Euro Mx E2	03-04	16 363 1860 (44830H3A600)	150	Vs Euro3	07-08	16 363 1830 (44830VS1100)
125	Fiddle li	08	16 363 1880 (44830ABA000)	200	Hd Eu2	03-04	16 363 1840 (44830E69000)
125	Fiddle li	09	16 363 1880 (44830ABA000)	200	Hd Euro3 I	07	16 363 1850 (44830HHA000)
125	Fiddle li	10-13	16 363 1880 (44830ABA000)	200	Hd Evo Eu2	05-06	16 363 1850 (44830HHA000)
125	Fiddle lii	14	16 363 1880 (44830ABA000)	200	Hd Evo Euro3 I	07	16 363 1850 (44830HHA000)
125	Hd Eu2	03-04	16 363 1820 (44830M96000)	200	Hd Evo I Euro3	10-12	16 363 1850 (44830HHA000)
125	Hd Euro3	07-08	16 363 1850 (44830HHA000)	200	Hd Evo I Tamburo Euro3	08-09	16 363 1850 (44830HHA000)
125	Hd Evo	05-06	16 363 1850 (44830HHA000)	200	Joyride	03	16 363 1870 (44830H9A000)
125	Hd Evo Euro3	07-08	16 363 1850 (44830HHA000)	200	Joyride Eu2	03-04	16 363 1870 (44830H9A000)
125	Hd Evo Euro3	10-11	16 363 1850 (44830HHA000)	TGB			
125	Hd Evo Tamburo Euro3	08-09	16 363 1850 (44830HHA000)	50	303-303 Rs-Hauk	-	16 363 1890
125	Jet V	11	16 363 1840 (44830E69000)	YAMAHA			
125	Jet4	09-10	16 363 1880 (44830ABA000)	50	Bw's	04-05	16 363 0530 (5WWH3550000)
125	Joyride	01-02	16 363 1870 (44830H9A000)	50	Bw's	06-07	16 363 0530 (5WWH3550000)
125	Joyride Eu2	05-06	16 363 1870 (44830H9A000)	50	Bw's	08-12	16 363 0530 (5WWH3550000)
125	Megalo	06-07	16 363 1840 (44830E69000)	50	Bw's	13-15	16 363 0530 (5WWH3550000)
125	New Duke	00-01	16 363 1840 (44830M91000)	50	Bw's Next Generation	97-98	16 363 1270 (4SBH35500300)
125	Super Duke	99-02	16 363 1800 (44830H08010)	50	Bw's Next Generation	99	16 363 1270 (4SBH35500300)
125	Symply	07-08	16 363 1880 (44830ABA000)	50	Bw's Next Generation	01-02	16 363 1270 (4SBH35500300)
125	Symply li	09-10	16 363 1880 (44830ABA000)	50	Bw's Next Generation	03	16 363 1270 (4SBH35500300)
125	Symply li	14	16 363 1880 (44830ABA000)	50	Bw's Next Generation	04-06	16 363 1270 (4SBH35500300)
125	Vs	06	16 363 1830 (44830VS1100)	50	Bw's Next Generation Cat.	99-00	16 363 1270 (4SBH35500300)
125	Vs Euro3	07-08	16 363 1830 (44830VS1100)	50	Bw's Original	97-98	16 363 1280 (4PAH35500200)
150	Attila	00-01	16 363 1840 (44830M91000)	50	Bw's Original	99	16 363 1280 (4PAH35500200)
150	Euro Mx	02	16 363 1860 (44830H3A600)	50	Bw's Original	99-00	16 363 1280 (4PAH35500200)
150	Euro Mx Eu2	03-04	16 363 1860 (44830H3A600)	50	Bw's Original	01-02	16 363 1280 (4PAH35500200)
150	Joyride	01-02	16 363 1870 (44830H9A000)	50	Bw's Original Eu2	03	16 363 1280 (4PAH35500200)
150	Shark	00-01	16 363 1860 (44830H3A600)	50	Cw Bw's Original Eu2	02	16 363 1280 (4PAH35500200)
				50	Cw L Bw's	03	16 363 1280 (4PAH35500200)
				50	Cw L Bw's	04	16 363 0530 (5WWH3550000)

TRASMISSIONI CONTACHILOMETRI

SPEEDOMETER TRANSMISSIONS



CC	MODELLO MODEL	ANNI YEARS	CONTACHILOMETRI SPEEDOMETER	CC	MODELLO MODEL	ANNI YEARS	CONTACHILOMETRI SPEEDOMETER
50	Cw Rs Spy	95-98	16 363 1270 (4SBH35500300)	250	Yp250 Majesty Dx	98	16 363 0630 (4HC835500000)
50	Cw Sp Bw's Original Eu2	02	16 363 1280 (4PAH35500200)	250	Yp250 Majesty Dx	99	16 363 0630 (4HC835500000)
50	Ew Slider	00-02	16 363 1270 (4SBH35500300)				
50	Yh Why	98	16 363 0620 (5EUH35500000)				
50	Yh Why	01-02	16 363 0620 (5EUH35500000)				
50	Yh Why	06	16 363 0620 (5EUH35500000)				
50	Yh Why Euro1	99-00	16 363 0620 (5EUH35500000)				
50	Yh Why Eu2	03-05	16 363 0620 (5EUH35500000)				
50	Ym Breeze	94-95	16 363 1280 (4PAH35500200)				
50	Yq Aerox	97-98	16 363 0520 (5BRH35500200)				
50	Yq Aerox	01-02	16 363 0520 (5BRH35500200)				
50	Yq Aerox	04	16 363 1140 (5PUH35500200)				
50	Yq Aerox	05	16 363 1140 (5PUH35500200)				
50	Yq Aerox	06	16 363 1140 (5PUH35500200)				
50	Yq Aerox	07	16 363 1140 (5PUH35500200)				
50	Yq Aerox	08	16 363 1140 (5PUH35500200)				
50	Yq Aerox	09	16 363 1140 (5PUH35500200)				
50	Yq Aerox	10-12	16 363 1140 (5PUH35500200)				
50	Yq Aerox R	99	16 363 0520 (5BRH35500200)				
50	Yq Aerox R	99-00	16 363 0520 (5BRH35500200)				
50	Yq L Aerox Eu2	03	16 363 1140 (5PUH35500200)				
100	Bw's	99-01	16 363 1290 (4VPH35500300)				
100	Yn Neo's	99-02	16 363 0570 (5ADH355010000)				
100	Yq Aerox	00-02	16 363 0520 (5BRH355002000)				
125	Nxc Cygnus X	04-06	16 363 0550 (5MLH35500000)				
125	Nxc Cygnus X	07-11	16 363 0560 (5MLH35501000)				
125	Yp125 Majesty	98-00	16 363 1340 (5DSH3550000)				
150	Yp150 Majesty	00	16 363 1340 (5DSH3550000)				
250	Yp250 Majesty	96-98	16 363 0630 (4HC835500000)				



TRASMISSIONI FRENO

BRAKE TRANSMISSIONS

CC	MODELLO MODEL	ANNI YEARS	FRENO ANTERIORE FRONT BRAKE	FRENO POSTERIORE REAR BRAKE
APRILIA				
50	Amico	94		16 355 5020 (AP8214104)
50	Amico	96-98		16 355 5020 (AP8214104)
50	Amico GL-GLE	93-95		16 355 5020 (AP8214104)
50	Amico Lx- Sport-Cat	92-93		16 355 5020 (AP8214104)
50	Gulliver	95-98		16 355 5030 (AP8214131)
50	Gulliver Lc	96-98		16 355 5030 (AP8214131)
50	Rally	95-03		16 355 5030 (AP8214131)
50	Scarabeo	93-97		16 355 5040 (AP8214123)
50	Scarabeo	98		16 355 5040 (AP8214123)
50	Scarabeo	99		16 355 5040 (AP8214123)
50	Scarabeo	00-05		16 355 5040 (AP8214123)
50	Sonic	98-07		16 355 5680 (AP8214174)
50	Sonic Gp	98-08		16 355 5680 (AP8214174)
50	Sr	93		16 355 5020 (AP8214104)
50	Sr	94-96		16 355 5030 (AP8214131)
50	Sr Liquid Cooled	94-96		16 355 5030 (AP8214131)
50	Sr Stealth, Racing	97-00		16 355 5030 (AP8214131)
50	Sr Www	97-01		16 355 5030 (AP8214131)
100	Scarabeo Motore Minarelli	00		16 355 5770 (AP8114395)
100	Scarabeo Motore Yamaha	00		16 355 5770 (AP8114395)
DERBI				
50	Sonar 2T	09		16 355 5370 (600561)
125	Sonar 4T	09-11		16 355 5370 (600561)
150	Sonar 4T	09		16 355 5370 (600561)
GILERA				
50	Easy Moving	95-96		16 355 5100 (271853)
50	Runner	97-00		16 355 5090 (562424)
50	Stalker	97-04		16 355 5080 (561151)
50	Stalker	05-06		16 355 5080 (561151)
50	Stalker	07-08		16 355 5080 (561151)
50	Stalker	09-11		16 355 5080 (561151)
50	Stalker Special Edition	07-08		16 355 5080 (561151)
50	Storm	94-95		16 355 5070 (270993)

CC	MODELLO MODEL	ANNI YEARS	FRENO ANTERIORE FRONT BRAKE	FRENO POSTERIORE REAR BRAKE
50	Storm Eu2	07		16 355 5070 (270993)
50	Typhoon	94-97		16 355 5070 (270993)
50	Typhoon X	98-99		16 355 5070 (270993)
125	Runner Fx-Fxr 125-180	97-02		16 355 5710 (563753)
125	Typhoon	95-98		16 355 5690 (560711)
125	Typhoon X-Xr	99-00		16 355 5690 (560711)
HONDA				
125	Sh			16 355 5910 (43450-KPR-900)
150	Sh			16 355 5910 (43450-KPR-900)
MALAGUTI				
50	F12 Aria Restyling Eu2	06		16 355 5140 (04802903)
50	F12 Phantom	94-98		16 355 5140 (04802903)
50	F12 Phantom Eu1	99-00		16 355 5140 (04802903)
50	F12 Phantom Lc	94-98		16 355 5140 (04802903)
50	F12 Phantom Restyling Eu1	01-02		16 355 5140 (04802903)
50	F12 Phantom Re-styling Eu2	02		16 355 5140 (04802903)
50	F12 Phantom Re-styling Eu2-2.3	03-04		16 355 5140 (04802903)
50	F15 Fire Fox	96-98		16 355 5170 (04803103)
50	F15 Fire Fox Air Cooled	05-06		16 355 5170 (04803103)
MBK				
50	Cw Booster	90-91		16 355 5180 (3VLF63510000)
50	Cw Booster	01-02		16 355 5670 (5JHF63510100)
50	Cw Booster	04		16 355 5250 (5WVWF63510000)
50	Cw Booster (ITA)	92-94		16 355 5180 (3VLF63510000)
50	Cw Booster Spirit	96-98		16 355 5180 (3VLF63510000)
50	Cw Booster Spirit (ITA)	99		16 355 5180 (3VLF63510000)
50	Cw Booster Spirit (ITA)	00		16 355 5180 (3VLF63510000)
50	Cw Booster Spirit Eu2	02		16 355 5670 (5JHF63510100)
50	Cw Booster Spirit Eu2	03		16 355 5670 (5JHF63510100)
50	Cw L Booster	01-03		16 355 5670 (5JHF63510100)
50	Cw L Booster Spirit	03		16 355 5670 (5JHF63510100)
50	Cw R Booster Road (ITA)	94-95		16 355 5180 (3VLF63510000)
50	Cw Rs Booster Ng (ITA)	95-98		16 355 5190 (4SBF63510000)
50	Cw Rs Booster Ng (ITA)	99		16 355 5190 (4SBF63510000)

TRASMISSIONI FRENO

BRAKE TRANSMISSIONS



CC	MODELLO MODEL	ANNI YEARS	FRENO ANTERIORE FRONT BRAKE	FRENO POSTERIORE REAR BRAKE	CC	MODELLO MODEL	ANNI YEARS	FRENO ANTERIORE FRONT BRAKE	FRENO POSTERIORE REAR BRAKE
50	Cw Rs Booster Ng Eu1	99-00		16 355 5190 (4SBF63510000)	50	Liberty 2T	07-08		16 355 5370 (600561)
50	Cw Rsp Booster Rocket (ITA)	97-98		16 355 5190 (4SBF63510000)	50	Liberty 2T Rst	04		16 355 5300 (597383)
50	Cw Rsx Booster Track (ITA)	96-98		16 355 5190 (4SBF63510000)	50	Liberty 2T Sport	06		16 355 5370 (600561)
50	Cw Sp Booster Spirit Eu2	02		16 355 5670 (5JHF63510100)	50	Liberty 2T Sport	07-08		16 355 5370 (600561)
50	Ew Stunt	00-02		16 355 5670 (5JHF63510100)	50	Liberty 4T	00-02		16 355 5300 (597383)
50	Yn R Ovetto (Che- ITa)	97-01		16 355 5220 (5ADF63510000)	50	Liberty 4T	05-08		16 355 5370 (600561)
50	Yn R Ovetto Eu1	02-04		16 355 5220 (5ADF63510000)	50	Liberty 4T Delivery - Single	10-14		16 355 5370 (600561)
50	Yn R Ovetto Eu2	02-03		16 355 5220 (5ADF63510000)	50	Liberty 4T Delivery Tnt	09		16 355 5370 (600561)
100	Yn Ovetto	00-02		16 355 5220 (5ADF63510000)	50	Liberty 4T Ptt - Double	09-12		16 355 5370 (600561)
PEUGEOT					50	Liberty 4T Ptt (Deu)	07-12		16 355 5370 (600561)
50	Metal-X	02		16 355 5880 (736927)	50	Liberty 4T Rst	04		16 355 5730 (564217)
50	Speedfight 2 Aria	05-06		16 355 5880 (736927)	50	Liberty 4T Sport	06		16 355 5370 (600561)
50	Speedfight 2 Lc-Silversport	05-06		16 355 5880 (736927)	50	Liberty 4T Sport	07-08		16 355 5370 (600561)
50	Speedfight Acqua	97-98		16 355 5880 (736927)	50	Liberty Moc 2T & Elle	09-13		16 355 5370 (600561)
50	Speedfight Aria	97-98		16 355 5880 (736927)	50	Liberty Moc 4T & Elle	09-13		16 355 5370 (600561)
50	Speedfight Aria Catalitico	99		16 355 5880 (736927)	50	Liberty Ptt Eu2	04-05		16 355 5300 (597383)
50	Trekker	98-00		16 355 5880 (736927)	50	Nrg	94-96		16 355 5070 (270993)
50	Trk2 Wrc	04-06		16 355 5880 (736927)	50	Nrg Extreme	99-00		16 355 5690 (560711)
50	Vivacity	99		16 355 5880 (736927)	50	Nrg Mc3	01-04		16 355 5690 (560711)
50	Vivacity Catalitico	99-02		16 355 5880 (736927)	50	Nrg Power Dt	06		16 355 5730 (564217)
50	Vivacity Vsx-Xr	02-04		16 355 5880 (736927)	50	Nrg Power Dt	07-11		16 355 5730 (564217)
50	X-Fight	00		16 355 5880 (736927)	50	Nrg Power Dt Serie Speciale	07-08		16 355 5730 (564217)
100	Trekker	98		16 355 5880 (736927)	50	Nrg Rst Mc2	96-98		16 355 5070 (270993)
100	Vivacity	99-01		16 355 5880 (736927)	50	Ntt	95-96		16 355 5070 (270993)
PIAGGIO					50	Quartz	92-96		16 355 5310 (266213)
50	Fly 2T	05-07		16 355 5930 (648078)	50	Sfera	91-93	16 355 0100 (268195)	16 355 5310 (266213)
50	Fly 2T	10-11		16 355 5930 (648078)	50	Sfera Maquillage 2	94	16 355 0100 (268195)	16 355 5310 (266213)
50	Fly 4T	05-07		16 355 5930 (648078)	50	Sfera Rst	95-97		16 355 5090 (562424)
50	Fly 4T & 25-30 Km/H	08-11		16 355 5930 (648078)	50	Typhoon	01-04		16 355 5070 (270993)
50	Fly 4T Motore Chn	06-07		16 355 5930 (648078)	50	Typhoon	05-08		16 355 5070 (270993)
50	Free Delivery	00-01		16 355 5300 (597383)	50	Typhoon	09-11		16 355 5070 (270993)
50	Free Fl	95-02		16 355 5300 (597383)	50	Typhoon 2T Eu2	10-12		16 355 5940 (666930)
50	Liberty	97-05		16 355 5300 (597383)					
50	Liberty 2T	06		16 355 5370 (600561)					



TRASMISSIONI FRENO

BRAKE TRANSMISSIONS

CC	MODELLO MODEL	ANNI YEARS	FRENOANTERIORE FRONT BRAKE	FRENO POSTERIORE REAR BRAKE	CC	MODELLO MODEL	ANNI YEARS	FRENOANTERIORE FRONT BRAKE	FRENO POSTERIORE REAR BRAKE
50	Typhoon 2T Eu3 Ch	11		16 355 5940 (666930)	125	Fly	05-07		16 355 5930 (648078)
50	Vespa Et2	97-05		16 355 5090 (562424)	125	Fly Eu3	07		16 355 5930 (648078)
50	Vespa Et2 Iniezione	97-00		16 355 5090 (562424)	125	Fly Eu3	08-11		16 355 5930 (648078)
50	Vespa Et4	00-05		16 355 5730 (564217)	125	Hexagon	94-97		16 355 5700 (564107)
50	Vespa Lx 2T	05-08		16 355 5090 (665912)	125	Hexagon Lx4	98-99		16 355 5700 (564107)
50	Vespa Lx 2T	09-13		16 355 5090 (665912)	125	Hexagon Lx-Lxt	98-99		16 355 5700 (564107)
50	Vespa Lx 2T Touring & 30Km	10-13		16 355 5090 (665912)	125	Liberty	98-00		16 355 5740 (597320)
50	Vespa Lx 4T	05-08		16 355 5730 (564217)	125	Liberty	01		16 355 5850 (564847)
50	Vespa Lx 4T-4V	09-13		16 355 5730 (564217)	125	Liberty	02		16 355 5730 (564217)
50	Vespa Lx 4T-4V Touring	10-13		16 355 5730 (564217)	125	Liberty 4T	06-07		16 355 5370 (600561)
50	Vespa S 2T & College	07-12		16 355 5090 (665912)	125	Liberty 4T 2V Eu3	09-12		16 355 5370 (600561)
50	Vespa S 4T-4V & College	08-10		16 355 5730 (564217)	125	Liberty 4T 2V le Ptt - Ita	12		16 355 5370 (600561)
50	Vespa S 4T-4V & College	11-12		16 355 5090 (665912)	125	Liberty 4T Eu3	06-08		16 355 5370 (600561)
50	Zip	92-93	16 355 0110 (269657)	16 355 5330 (269656)	125	Liberty 4T Eu3 Delivery - Single	07-15		16 355 5370 (600561)
50	Zip	95-96	16 355 0110 (269657)	16 355 5330 (269656)	125	Liberty 4T Eu3 Delivery - Tnt	08-09		16 355 5370 (600561)
50	Zip	02		16 355 5920 (564988)	125	Liberty 4T Sport Eu3	06-08		16 355 5370 (600561)
50	Zip	00-04		16 355 5360 (560781)	125	Liberty Rst	04-05		16 355 5730 (564217)
50	Zip 2T	08-13		16 355 5920 (564988)	125	Liberty Rst Ptt	05-11		16 355 5370 (600561)
50	Zip 4T	00-05		16 355 5840 (597141)	125	Liberty Sport	06		16 355 5370 (600561)
50	Zip 4T	06-13		16 355 5840 (597141)	125	Skipper	94-97		16 355 5310 (266213)
50	Zip Bimodale	94-97	16 355 0110 (269657)	16 355 5330 (269656)	125	Skipper 4T	00-02		16 355 5750 (564474)
50	Zip Fast Raider	93-94		16 355 5100 (271853)	125	Typhoon 4T 2V Eu3	10-11		16 355 5940 (666930)
50	Zip Fast Raider Rst	96-97		16 355 5360 (560781)	125	Vespa Et4	96-98		16 355 5090 (562424)
50	Zip Rst	96-99	16 355 0130 (560752)	16 355 5360 (560781)	125	Vespa Et4	99-02		16 355 5730 (564217)
50	Zip Sp	96-00		16 355 5360 (560781)	125	Vespa Lx	05-06		16 355 5730 (564217)
50	Zip Sp	01-04		16 355 5920 (564988)	125	Vespa Lx 4T Eu3 Touring	10-11		16 355 5730 (564217)
50	Zip Sp Eu2	06-13		16 355 5920 (564988)	125	Vespa Lx 4T FL	09		16 355 5730 (564217)
80	Skr City	99	16 355 0100 (268195)		125	Vespa Lx Eu3	06-08		16 355 5730 (564217)
100	Fly 4T	06-07		16 355 5930 (648078)	125	Vespa Lx Eu3 ie	09-11		16 355 5730 (564217)
100	Fly 4T	08		16 355 5930 (601736)	125	Vespa S 4T Euro 3	07-08		16 355 5730 (564217)
100	Free	02-03		16 355 5300 (597383)	125	Vespa S 4T le & College	09-11		16 355 5730 (564217)
100	Zip 4T	06-10		16 355 5840 (597141)	125	Zip	00-02		16 355 5840 (597141)

TRASMISSIONI FRENO BRAKE TRANSMISSIONS



CC	MODELLO MODEL	ANNI YEARS	FRENO ANTERIORE FRONT BRAKE	FRENO POSTERIORE REAR BRAKE	CC	MODELLO MODEL	ANNI YEARS	FRENO ANTERIORE FRONT BRAKE	FRENO POSTERIORE REAR BRAKE
150	Fly	05-07		16 355 5930 (648078)	50	Bw's Original	99-00		16 355 5180 (3VLF63510000)
150	Fly Eu3	08-11		16 355 5930 (648078)	50	Bw's Original	01-02		16 355 5670 (5JHF63510200)
150	Liberty 4T Eu3	08		16 355 5370 (600561)	50	Bw's Original Eu2	03		16 355 5670 (5JHF63510100)
150	Liberty 4T Sport Eu3	08		16 355 5370 (600561)	50	Cw Bw's Original Eu2	02		16 355 5670 (5JHF63510100)
150	Liberty Moc 4T Eu3	09-13		16 355 5370 (600561)	50	Cw L Bw's	03		16 355 5670 (5JHF63510100)
150	Vespa Lx	05-06		16 355 5730 (564217)	50	Cw L Bw's	04		16 355 5670 (5JHF63510100)
150	Vespa Lx 4T FL	09		16 355 5730 (564217)	50	Cw Rs Spy	95-98		16 355 5190 (4SBF63510000)
150	Vespa Lx Eu3	06-08		16 355 5730 (564217)	50	Cw Sp Bw's Original Eu2	02		16 355 5670 (5JHF63510100)
150	Vespa Lx Euro 3 ie	09-11		16 355 5730 (564217)	50	Ew Slider	00-02		16 355 5670 (5JHF63510200)
150	Vespa Lx Touring	10-12		16 355 5730 (564217)	50	Yn Neo's	04-06		16 355 5220 (5ADF63510000)
150	Vespa S 4T	08-09		16 355 5730 (564217)	50	Yn Neo's Eu2	02-03		16 355 5220 (5ADF63510000)
150	Vespa S 4T le & College	09-12		16 355 5730 (564217)	50	Yn R Neo's	97-01		16 355 5220 (5ADF63510000)
200	Liberty	06		16 355 5370 (600561)	50	Yn R Neo's	02		16 355 5220 (5ADF63510000)
200	Liberty 4T Eu3	06-08		16 355 5370 (600561)	100	Yn Neo's	99-02		16 355 5220 (5ADF63510000)
200	Liberty 4T Sport Eu3	06-07		16 355 5370 (600561)					
200	Liberty Rst	04		16 355 5730 (564217)					
200	Liberty Sport	06		16 355 5370 (600561)					
250	Hexagon Gt-Gtx	98-00		16 355 5700 (564107)					
YAMAHA									
50	Bw's	04-05		16 355 5250 (5WWF63510000)					
50	Bw's	06-07		16 355 5250 (5WWF63510000)					
50	Bw's	08-12		16 355 5250 (5WWF63510000)					
50	Bw's	13-15		16 355 5250 (5WWF63510000)					
50	Bw's Bump	97-98		16 355 5190 (4SBF63510000)					
50	Bw's Easy	13		16 355 5250 (5WWF63510000)					
50	Bw's Naked	04		16 355 5240 (2B7F63510000)					
50	Bw's Naked	09-12		16 355 5240 (2B7F63510000)					
50	Bw's Naked	13		16 355 5240 (2B7F63510000)					
50	Bw's Next Generation	97-98		16 355 5190 (4SBF63510000)					
50	Bw's Next Generation	99		16 355 5190 (4SBF63510000)					
50	Bw's Next Generation Cat.	99-00		16 355 5190 (4SBF63510000)					
50	Bw's Original	97-98		16 355 5180 (3VLF63510000)					
50	Bw's Original	99		16 355 5180 (3VLF63510000)					



TRASMISSIONI GAS

THROTTLE TRANSMISSIONS

CC	MODELLO MODEL	ANNI YEARS	CAVO GAS THROTTLE	COMANDO SDOPPIATORE CONTROL SPLITTER	SDOPPIATORE MISCELATORE SPLITTER MIX	SDOPPIATORE CARBURATORE CARBURATOR SPLITTER
APRILIA						
50	Amico	94	16 359 0020 (AP8214109)			
50	Amico	96-98	16 359 0020 (AP8214109)			
50	Amico GL-GLE	93-95	16 359 0020 (AP8214109)			
50	Amico Lx- Sport-Cat	92-93	16 359 0020 (AP8214109)			
50	Gulliver	95-98	16 359 0050 (AP8214160)			
50	Gulliver Lc	96-98	16 359 0050 (AP8214160)			
50	Rally	95-03	16 359 0050 (AP8214160)			
50	Rally Liquid Cooled	96-99	16 359 0040 (AP8214167)			
50	Scarabeo	93-97	16 359 0030 (AP8214125)			
50	Scarabeo	98	16 359 0030 (AP8214125)			
50	Scarabeo	99	16 359 0030 (AP8214125)			
50	Scarabeo	00-05	16 359 0030 (AP8214125)			
50	Sonic	98-07	16 359 0330 (AP8214172)			
50	Sonic Gp	98-08	16 359 0330 (AP8214172)			
50	Sr	93	16 359 0020 (AP8214109)			
50	Sr	94-96	16 359 0020 (AP8214109)			
50	Sr Liquid Cooled	94-96	16 359 0020 (AP8214109)			
50	Sr Stealth, Racing	97-00	16 359 0060 (AP8214162)			
50	Sr Www	97-01	16 359 0060 (AP8214162)			
125	Leonardo	96-98	16 359 0200 (AP8114299)			
125	Leonardo	99-02	16 359 0660 (AP8114388)			
125	Leonardo St	01-04	16 359 0660 (AP8114388)			
125	Scarabeo Motore Rotax	99-04	16 359 0370 (AP8114382)			
125	Sr	99-01	16 359 2220 (AP8114380)			
250	Leonardo	99-01	16 359 0440 (AP8114369)			
250	Leonardo	02-04	16 359 0440 (AP8114369)			
250	Leonardo St	01	16 359 0440 (AP8114369)			



CC	MODELLO MODEL	ANNI YEARS	CAVO GAS THROTTLE	COMANDO SDOPPIATORE CONTROL SPLITTER	SDOPPIATORE MISCELATORE SPLITTER MIX	SDOPPIATORE CARBURATORE CARBURATOR SPLITTER
GILERA						
50	Dna	00-02			16 359 5150 (582449)	
50	Dna	05-07			16 359 5150 (582449)	
50	Dna Gp Experience	03-04			16 359 5150 (582449)	
50	Easy Moving	95-96	16 359 2150 (268435)		16 359 5040 (271829)	16 359 7020 (268402)
50	Ice	01-05				16 359 7300 (583334)
50	Runner	97-00	16 359 2030 (562583) 16 359 2270 Freno a Disco <i>Brake disc</i> (563878)		16 359 5030 (268403)	16 359 7030 (581173)
50	Runner Poggiali	02	16 359 2270 (563878)			
50	Runner Purejet	02-04	16 359 2270 (563878)		16 359 5030 (268403)	
50	Runner Sp	02-04	16 359 2270 (563878)		16 359 5030 (268403)	
50	Runner Sp Special Edition	07			16 359 5030 (268403)	
50	Stalker	97-04	16 359 2450 (561149)		16 359 5030 (268403)	
50	Stalker	05-06	16 359 2450 (561149)		16 359 5030 (268403)	
50	Stalker	07-08	16 359 2450 (561149)		16 359 5030 (268403)	
50	Stalker	09-11	16 359 2450 (561149)		16 359 5030 (268403)	
50	Stalker Naked	08			16 359 5030 (268403)	
50	Stalker Special Edition	07-08	16 359 2450 (561149)			
50	Storm	94-95			16 359 5010 (272290)	16 359 7010 (272289)
50	Storm Eu2	07		16 359 2240 (581539)	16 359 5150 (582449)	
50	Typhoon	94-97			16 359 5010 (272290)	16 359 7010 (272289)
50	Typhoon X	98-99			16 359 5010 (272290)	16 359 7010 (272289)
50	Typhoon Xr	00			16 359 5010 (272290)	16 359 7010 (272289)
125	Runner Fx-Fxr 125-180	99-00	16 359 2270 (563878)		16 359 5150 (582449)	16 359 7210 Dell'Orto (563213)
125	Runner Fx-Fxr 125-180	01-02	16 359 2030 (562583)		16 359 5150 (582449)	16 359 7210 Dell'Orto (563213)
125	Typhoon	95-98			16 359 5010 (272290)	
125	Typhoon X-Xr	99-00			16 359 5010 (272290)	



TRASMISSIONI GAS

THROTTLE TRANSMISSIONS

CC	MODELLO MODEL	ANNI YEARS	CAVO GAS THROTTLE	COMANDO SDOPPIATORE CONTROL SPLITTER	SDOPPIATORE MISCELATORE SPLITTER MIX	SDOPPIATORE CARBURATORE CARBURATOR SPLITTER
HONDA						
50	Sgx Sky	-	16 359 0160			
125	Sh	-	16 359 0460			
125	Chiocciola Nes	-	16 359 0460			
150	Sh	-	16 359 0460			
150	Chiocciola Nes	-	16 359 0460			
MALAGUTI						
50	Ciak Master	04		16 359 2060 (03407803)		
50	Ciak Mono Eu2 2.3	03		16 359 2060 (03407803)		
50	F10 Jet Line	92-98	16 359 0080 (03408003)			
50	F10 Kat	99-00	16 359 0080 (03408003)			
50	F10 Restyling Eu1	01-02	16 359 0080 (03408003)			
50	F10 Restyling Eu2	02-03	16 359 0080 (03408003)			
50	F10 Restyling Eu2	06	16 359 0080 (03408003)			
50	F12 Aria Restyling Eu2	06	16 359 0080 (03408003)			
50	F12 Lc Restyling Eu2	06	16 359 0080 (03408003)			
50	F12 Phantom	94-98	16 359 0080 (03408003)	16 359 2060 (03407803)		
50	F12 Phantom Eu1	99-00	16 359 0080 (03408003)			
50	F12 Phantom Lc	94-98	16 359 0080 (03408003)	16 359 2060 (03407803)		
50	F12 Phantom Lc Eu1	99-00	16 359 0080 (03408003)			
50	F12 Phantom Lc Restyling Eu1	01-02	16 359 0080 (03408003)			
50	F12 Phantom Lc Restyling Eu2	02		16 359 2060 (03407803)		
50	F12 Phantom Lc Restyling Eu2-2.3	03-04		16 359 2060 (03407803)		
50	F12 Phantom Lc Twin Disks	98	16 359 0080 (03408003)			
50	F12 Phantom Restyling Eu1	01-02	16 359 0080 (03408003)			
50	F12 Phantom Restyling Eu2	02	16 359 0080 (03408003)			
50	F12 Phantom Restyling Eu2-2.3	03-04		16 359 2060 (03407803)		
50	F15 Fire Fox	96-98	16 359 0080 (03408003)			
50	F15 Fire Fox Air Cooled	05-06	16 359 0080 (03408003)			
50	F15 Fire Fox Eu2	02-03		16 359 2060 (03407803)		
50	F15 Fire Fox Restyling Eu2-2.3	03-04		16 359 2060 (03407803)		
50	F15 Fire Fox Twin Disks & Special	98-99	16 359 0080 (03408003)			



CC	MODELLO MODEL	ANNI YEARS	CAVO GAS THROTTLE	COMANDO SDOPPIATORE CONTROL SPLITTER	SDOPPIATORE MISCELATORE SPLITTER MIX	SDOPPIATORE CARBURATORE CARBURATOR SPLITTER
50	F15 Fire Fox Twin Disks Digit Kat	98-00	16 359 0080 (03408003)			
50	F15 Lc Restyling Eu2	04-05	16 359 0080 (03408003)			
50	F15 Lc-Tds Restyling Eu1	01	16 359 0080 (03408003)			
50	Yesterday - Yesterday Eu	97-00	16 359 0080 (03408003)			
MBK						
50	Cr Z Target	91-95				16 359 7100 (3GFF63120000)
50	Ct S Sorri So	91-92		16 359 2090 (1NTF63110000)		
50	Ct Ss Sorri So	93-95		16 359 2090 (1NTF63110000)		
50	Cw Booster	90-91		16 359 2070 (3VLF63110100)		16 359 7060 (3VFL63120100)
50	Cw Booster	01-02		16 359 2070 (3VLF63110100)		16 359 7060 (3VFL63120100)
50	Cw Booster	04	16 359 7320	16 359 2070 (3VLF63110100)		
50	Cw Booster (Ita)	92-94		16 359 2070 (3VLF63110100)		16 359 7060 (3VFL63120100)
50	Cw Booster Naked	03		16 359 2070 (3VLF63110100)		16 359 7060 (3VFL63120100)
50	Cw Booster Spirit	96-98		16 359 2070 (3VLF63110100)		16 359 7060 (3VFL63120100)
50	Cw Booster Spirit (Ita)	99		16 359 2070 (3VLF63110100)		16 359 7060 (3VFL63120100)
50	Cw Booster Spirit (Ita)	00		16 359 2070 (3VLF63110100)		16 359 7060 (3VFL63120100)
50	Cw Booster Spirit Eu2	02		16 359 2070 (3VLF63110100)		16 359 7060 (3VFL63120100)
50	Cw Booster Spirit Eu2	03		16 359 2070 (3VLF63110100)		16 359 7060 (3VFL63120100)
50	Cw L Booster	01-03		16 359 2070 (3VLF63110100)		16 359 7060 (3VFL63120100)
50	Cw L Booster Spirit	03		16 359 2070 (3VLF63110100)		16 359 7060 (3VFL63120100)
50	Cw R Booster Road (Ita)	94-95		16 359 2070 (3VLF63110100)		16 359 7060 (3VFL63120100)
50	Cw Rs Booster Ng	01-02		16 359 2070 (3VLF63110100)		16 359 7060 (3VFL63120100)
50	Cw Rs Booster Ng	03		16 359 2070 (3VLF63110100)		16 359 7060 (3VFL63120100)
50	Cw Rs Booster Ng (Ita)	95-98		16 359 2070 (3VLF63110100)		16 359 7060 (3VFL63120100)
50	Cw Rs Booster Ng (Ita)	99		16 359 2070 (3VLF63110100)		16 359 7060 (3VFL63120100)
50	Cw Rs Booster Ng Euro1	99-00		16 359 2070 (3VLF63110100)		16 359 7060 (3VFL63120100)
50	Cw Rsp Booster Rocket (Ita)	97-98		16 359 2070 (3VLF63110100)		16 359 7060 (3VFL63120100)
50	Cw Rxs Booster Track (Ita)	96-98		16 359 2070 (3VLF63110100)		16 359 7060 (3VFL63120100)
50	Cw Sp Booster Spirit Eu2	02		16 359 2070 (3VLF63110100)		16 359 7060 (3VFL63120100)



TRASMISSIONI GAS

THROTTLE TRANSMISSIONS

CC	MODELLO MODEL	ANNI YEARS	CAVO GAS THROTTLE	COMANDO SDOPPIATORE CONTROL SPLITTER	SDOPPIATORE MISCELATORE SPLITTER MIX	SDOPPIATORE CARBURATORE CARBURATOR SPLITTER
50	Ew Stunt	00-02		16 359 2230 (4UYF63110000)		16 359 7180 (4UYF63120000)
50	Yh Flipper	98	16 359 2210			16 359 7180 (4UYF63120000)
50	Yh Flipper	01-02	16 359 2210			16 359 7180 (4UYF63120000)
50	Yh Flipper Catali Ti Co	99-00	16 359 2210			16 359 7180 (4UYF63120000)
50	Yh Flipper Eu2	03-04	16 359 2210			16 359 7180 (4UYF63120000)
50	Yn R Ovetto (Che- Ita)	97-01		16 359 2100 (5ADF63110100)		16 359 7090 (5RNF63122000)
50	Yn R Ovetto Eu1	02-04		16 359 2100 (5ADF63110100)		16 359 7090 (5RNF63122000)
50	Yn R Ovetto Eu2	02-03		16 359 2100 (5ADF63110100)		16 359 7090 (5RNF63122000)
50	Yq L Nitro Jaguar	04	16 359 2110			16 359 7060 (3VFL63120100)
50	Yq Nitro	01-02	16 359 2110			16 359 7060 (3VFL63120100)
50	Yq Nitro	04	16 359 2110			16 359 7060 (3VFL63120100)
50	Yq Nitro (Ita)	97-98	16 359 2110			16 359 7060 (3VFL63120100)
50	Yq Nitro (Ita)	99-00	16 359 2110			16 359 7060 (3VFL63120100)
50	Yq Nitro Eu2	03				16 359 7060 (3VFL63120100)
125	Yp Skyliner	98-00	16 359 0190			
125	Yp Skyliner	01-02	16 359 0190			
150	Yp Skyliner	00	16 359 0190			
150	Yp Skyliner	01-02	16 359 0190			
PIAGGIO						
50	Fly 2T	05-07		16 359 2240 (581539)	16 359 5030 (268403)	16 359 7300 (583334)
50	Fly 2T	10-11		16 359 2240 (581539)	16 359 5030 (268403)	
50	Fly 4T	05-07	16 359 2520 (601113)			
50	Fly 4T & 25-30 Km/H	08-11	16 359 2520 (601113)			
50	Fly 4T Motore Chn	06-07	16 359 2520 (601113)			
50	Free	92-94		16 359 2140 (581132)	16 359 5050 (268597)	16 359 7120 (269064)
50	Free Delivery	00-01		16 359 2140 (581132)	16 359 5050 (268597)	16 359 7120 (269064)
50	Free FL	95-02		16 359 2140 (581132)	16 359 5050 (268597)	16 359 7120 (269064)
50	Liberty	97-05		16 359 2150 (268435)	16 359 5080 (560448) 16 359 5030 MY02 (268403)	16 359 7030 (581173)
50	Liberty 2T	06			16 359 5030 (268403)	16 359 7300 (583334)

TRASMISSIONI GAS
THROTTLE TRANSMISSIONS



CC	MODELLO MODEL	ANNI YEARS	CAVO GAS THROTTLE	COMANDO SDOPPIATORE CONTROL SPLITTER	SDOPPIATORE MISCELATORE SPLITTER MIX	SDOPPIATORE CARBURATORE CARBURATOR SPLITTER
50	Liberty 2T	07-08			16 359 5030 (268403)	16 359 7300 (583334)
50	Liberty 2T Rst	04			16 359 5030 (268403)	16 359 7300 (583334)
50	Liberty 2T Sport	06			16 359 5030 (268403)	16 359 7300 (583334)
50	Liberty 2T Sport	07-08			16 359 5030 (268403)	16 359 7300 (583334)
50	Liberty 4T	00-02	16 359 2390 (582426)			
50	Liberty 4T Rst	04	16 359 2390 (582426)			
50	Liberty Moc 2T & Elle	09-13			16 359 5030 (268403)	16 359 7300 (583334)
50	Liberty Ptt Eu2	04-05			16 359 5030 (268403)	16 359 7300 (583334)
50	Nrg	94-96		16 359 2010 (270995)	16 359 5010 (272290)	16 359 7010 (272289)
50	Nrg Extreme Aria Tamburo - Ac Brake Drum	99-00		16 359 2240 (581539)	16 359 5080 (560448)	16 359 7020 (268402)
50	Nrg Extreme Liquido Doppio Disco Lc Brake Disc	99-00		16 359 2240 (581539)	16 359 5140 (583808)	16 359 7030 (581173)
50	Nrg Mc3 Tamburo - Brake Drum	01-04		16 359 2240 (581539)	16 359 5080 (560448)	16 359 7030 (581173)
50	Nrg Mc3 Disco - Brake Drum	01-04		16 359 2240 (581539)	16 359 5140 (583808)	
50	Nrg Power Dd	05		16 359 2240 (581539)		
50	Nrg Power Dd	06		16 359 2240 (581539)		
50	Nrg Power Dd Serie Speciale	07-12		16 359 2240 (581539)		
50	Nrg Power Dt	06		16 359 2240 (581539)		
50	Nrg Power Dt	07-11		16 359 2240 (581539)		
50	Nrg Power Dt Serie Speciale	07-08		16 359 2240 (581539)		
50	Nrg Power Purejet	06		16 359 2240 (581539)		
50	Nrg Power Purejet	07-09		16 359 2240 (581539)		
50	Nrg Purejet	02-04		16 359 2240 (581539)	16 359 5080 (560448)	
50	Nrg Rst Mc2	96-98		16 359 2280 (563902)	16 359 5140 (583808)	16 359 7030 (581173)
50	Ntt	95-96		16 359 2010 (270995)	16 359 5010 (272290)	16 359 7010 (272289)
50	Quartz	92-96		16 359 2150 (268435)	16 359 5030 (268403)	16 359 7020 (268402)
50	Sfera Maquillage 2	94			16 359 5070 (268812)	16 359 7140 (268811)
50	Sfera Rst	95-97		16 359 2150 (268435)	16 359 5080 (560448)	16 359 7020 (268402)
50	Sfera	91-93		16 359 2160 (267981)	16 359 5060 (267018)	
50	Typhoon	01-04			16 359 5080 (560448)	16 359 7300 (583334)



TRASMISSIONI GAS

THROTTLE TRANSMISSIONS

CC	MODELLO MODEL	ANNI YEARS	CAVO GAS THROTTLE	COMANDO SDOPPIATORE CONTROL SPLITTER	SDOPPIATORE MISCELATORE SPLITTER MIX	SDOPPIATORE CARBURATORE CARBURATOR SPLITTER
50	Typhoon	05-08		16 359 2240 (581539)	16 359 5150 (563276)	16 359 7300 (583334)
50	Typhoon	09-11		16 359 2240 (581539)	16 359 5150 (563276)	16 359 7300 (583334)
50	Typhoon 2T Eu2	10-12			16 359 5030 (268403)	
50	Typhoon 2T Eu3 Ch	11			16 359 5030 (268403)	
50	Vespa Et2	97-05		16 359 2200 (581883)	16 359 5110 (562408)	16 359 7170 (582908)
50	Vespa Et2 Iniezione	97-00		16 359 2200 (581883)	16 359 5110 (562408)	
50	Vespa Et4	00-05	16 359 2390 (582426)			
50	Zip	92-93		16 359 2180 (269059)	16 359 5070 (268812)	16 359 7140 (268811)
50	Zip (Freno A Disco-Brake Drum)	95-96		16 359 2150 (268435)	16 359 5040 (271829)	16 359 7020 (268402)
50	Zip (Freno A Disco-Brake Drum)	95-96		16 359 2180 (269059)	16 359 5070 (268812)	16 359 7140 (268811)
50	Zip	00-04		16 359 2450 (561149)	16 359 5080 (560448)	16 359 7300 (583334)
50	Zip 2T	08-13		16 359 2450 (561149)	16 359 5080 (560448)	16 359 7300 (583334)
50	Zip 4T	00-05		16 359 2490 (582663)		
50	Zip 4T	06-13		16 359 2480 (646791)		
50	Zip Bimodale	94-97			16 359 5070 (268812)	16 359 7140 (268811)
50	Zip Fast Raider	93-94		16 359 2150 (268435)	16 359 5040 (271829)	16 359 7020 (268402)
50	Zip Fast Raider Rst	96-97		16 359 2150 (268435)	16 359 5080 (560448)	16 359 7020 (268402)
50	Zip Rst (Freno A Disco-Brake Drum)	96-99		16 359 2150 (268435)	16 359 5080 (560448)	16 359 7020 (268402)
50	Zip Rst (Freno A Tamburo-Brake Drum)	96-99		16 359 2180 (269059)	16 359 5070 (268812)	16 359 7140 (268811)
50	Zip Sp	96-00		16 359 2150 (268435)	16 359 5080 (560448)	16 359 7020 (268402)
50	Zip Sp	01-04		16 359 2450 (561149)	16 359 5080 (560448)	
50	Zip Sp Eu2	06-13		16 359 2450 (561149)	16 359 5080 (560448)	
100	Fly 4T	06-07	16 359 2520 (601113)			
100	Fly 4T	08	16 359 2520 (601113)			
100	Free	02-03		16 359 2140 (581132)		
100	Zip 4T	06-10		16 359 2480 (646791)		
125	Fly	05-07	16 359 2500 (CM073305)			
125	Fly Eu3	07	16 359 2520 (601113)			



CC	MODELLO MODEL	ANNI YEARS	CAVO GAS THROTTLE	COMANDO SDOPPIATORE CONTROL SPLITTER	SDOPPIATORE MISCELATORE SPLITTER MIX	SDOPPIATORE CARBURATORE CARBURATOR SPLITTER
125	Fly Eu3	08-11	16 359 2510 (649603) Chiude- <i>Close</i> 16 359 2530 (649602) Apre - <i>Open</i>			
125	Liberty	1998	16 359 0130 (561804)			
125	Liberty	99-00	16 359 2260 (CM065903)			
125	Liberty	01-02	16 359 2350 (CM065904)			
125	Sfera	95-97	16 359 0130 (561804)			
125	Skipper	94-97		16 359 2150 (268435)		
125	Skipper 4T	00-02	16 359 0390 (CM065912)			
125	Typhoon 4T 2V Eu3	10-11	16 359 2510 (649603) Chiude- <i>Close</i> 16 359 2530 (649602) Apre - <i>Open</i>			
125	Vespa Et4	8/96- 98	16 359 0130 (561804)			
125	Vespa Et4	9/98- 99	16 359 2260 (CM065903)			
125	Vespa Et4	99-02	16 359 0360 (CM065907)			
125	X9	01-02		16 359 0690 (CM065911)		
125	X9 Evolution	03		16 359 0690 (CM065911)		
150	Fly	05-07	16 359 2500 (CM073305)			
150	Fly Eu3	08-11	16 359 2510 (649603) Chiude- <i>Close</i> 16 359 2530 (649602) Apre - <i>Open</i>			
180	X9 Amalfi	00-03		16 359 0690 (CM065911)		
200	X9 Evolution	03		16 359 0690 (CM065911)		
250	X9 Evolution	04		16 359 0690 (CM065911)		
YAMAHA						
50	Bw's	04-05		16 359 2070 (3VLF63110100)		
50	Bw's	06-07		16 359 2070 (3VLF63110100)		
50	Bw's	08-12		16 359 2070 (3VLF63110100)		
50	Bw's Bump	97-98		16 359 2070 (3VLF63110100)		
50	Bw's Naked	03		16 359 2070 (3VLF63110100)		



TRASMISSIONI GAS

THROTTLE TRANSMISSIONS

CC	MODELLO MODEL	ANNI YEARS	CAVO GAS THROTTLE	COMANDO SDOPPIATORE CONTROL SPLITTER	SDOPPIATORE MISCELATORE SPLITTER MIX	SDOPPIATORE CARBURATORE CARBURATOR SPLITTER
50	Bw's Naked	04		16 359 2470 (2B7F6311000)		
50	Bw's Naked	09-12		16 359 2470 (2B7F6311000)		
50	Bw's Next Generation	97-98		16 359 2070 (3VLF63110100)		
50	Bw's Next Generation	99		16 359 2070 (3VLF63110100)		
50	Bw's Next Generation	01-02		16 359 2070 (3VLF63110100)		
50	Bw's Next Generation	03		16 359 2070 (3VLF63110100)		
50	Bw's Next Generation	04-06		16 359 2070 (3VLF63110100)		
50	Bw's Next Generation Cat.	99-00		16 359 2070 (3VLF63110100)		
50	Bw's Original	97-98		16 359 2070 (3VLF63110100)		
50	Bw's Original	99		16 359 2070 (3VLF63110100)		
50	Bw's Original	99-00		16 359 2070 (3VLF63110100)		
50	Bw's Original	01-02		16 359 2070 (3VLF63110100)		
50	Bw's Original Eu2	03		16 359 2070 (3VLF63110100)		
50	Bw's R	01		16 359 2070 (3VLF63110100)		
50	Ct S	90-95		16 359 2090 (1NTF63110000)		
50	Ct Ss	92-95		16 359 2090 (1NTF63110000)		
50	Cw Bw's Original Eu2	02		16 359 2070 (3VLF63110100)		
50	Cw L Bw's	03		16 359 2070 (3VLF63110100)		
50	Cw L Bw's	04		16 359 2070 (3VLF63110100)		
50	Cw Rs Spy	95-98		16 359 2070 (3VLF63110100)		
50	Cw Sp Bw's Original Eu2	02		16 359 2070 (3VLF63110100)		
50	Ew Slider	00-02		16 359 2230 (4UYF63110000)		
50	Yh Why	98		16 359 2210 (5EUF63110000)		
50	Yh Why	01-02		16 359 2210 (5EUF63110000)		
50	Yh Why	06		16 359 2210 (5EUF63110000)		
50	Yh Why Eu1	99-00		16 359 2210 (5EUF63110000)		
50	Yh Why Eu2	03-05		16 359 2210 (5EUF63110000)		
50	Yn Neo's	04-06		16 359 2100 (5ADF63110100)		
50	Yn Neo's Eu2	02-03		16 359 2100 (5ADF63110100)		



CC	MODELLO MODEL	ANNI YEARS	CAVO GAS THROTTLE	COMANDO SDOPPIATORE CONTROL SPLITTER	SDOPPIATORE MISCELATORE SPLITTER MIX	SDOPPIATORE CARBURATORE CARBURATOR SPLITTER
50	Yn R Neo's	97-01		16 359 2100 (5ADF63110100)		
50	Yn R Neo's	02		16 359 2100 (5ADF63110100)		
50	Yq Aerox	97-98		16 359 2110 (5BRF63110000)		
50	Yq Aerox	01-02		16 359 2110 (5BRF63110000)		
50	Yq Aerox	04		16 359 2110 (5BRF63110000)		
50	Yq Aerox	05		16 359 2110 (5BRF63110000)		
50	Yq Aerox	06		16 359 2110 (5BRF63110000)		
50	Yq Aerox	07		16 359 2110 (5BRF63110000)		
50	Yq Aerox	08		16 359 2110 (5BRF63110000)		
50	Yq Aerox	09		16 359 2070 (3VLF63110100)		
50	Yq Aerox	10-12		16 359 2070 (3VLF63110100)		
50	Yq Aerox R	99		16 359 2110 (5BRF63110000)		
50	Yq Aerox R	99-00		16 359 2110 (5BRF63110000)		
50	Yq L Aerox Eu2	03		16 359 2110 (5BRF63110000)		
125	Yp125 Majesty	98-00	16 359 0190			
150	Yp150 Majesty	00	16 359 0190			



TRASMISSIONI STARTER

STARTER TRANSMISSIONS

CC	MODELLO MODEL	ANNI YEARS	STARTER SUPERIORE STARTER UPPER CABLE	STARTER INFERIORE STARTER LOWER CABLE
APRILIA				
50	Amico	94	16 361 0010 (AP8214108)	
50	Amico	96-98	16 361 0010 (AP8214108)	
50	Amico GL-GLE	93-95	16 361 0010 (AP8214108)	
50	Amico Lx- Sport-Cat	92-93	16 361 0010 (AP8214108)	
50	Gulliver	95-98	16 361 0030 (AP8214159)	
50	Gulliver Lc	96-98	16 361 0030 (AP8214159)	
50	Rally	95-03	16 361 0030 (AP8214159)	
50	Rally Liquid Cooled	96-99	16 361 0100 (AP8214166)	
50	Scarabeo	93-97	16 361 0020 (AP8214124)	
50	Scarabeo	98	16 361 0020 (AP8214124)	
50	Scarabeo	99	16 361 0020 (AP8214124)	
50	Scarabeo	00-05	16 361 0020 (AP8214124)	
50	Sonic	98-07	16 361 0090 (AP8214171)	
50	Sonic Gp	98-08	16 361 0090 (AP8214171)	
50	Sr	93	16 361 0010 (AP8214108)	
50	Sr	93	16 361 0010 (AP8214108)	
50	Sr Liquid Cooled	94-96	16 361 0010 (AP8214108)	
50	Sr Stealth, Racing	97-00	16 361 0030 (AP8214159)	
50	Sr Www	97-01	16 361 0030 (AP8214159)	
MBK				
50	Cw Booster	90-91	16 361 3010 (3VLF63310000)	16 361 6010 (3VLF63340200)
50	Cw Booster	01-02	16 361 3010 (3VLF63310000)	16 361 6010 (3VLF63340200)
50	Cw Booster (ITA)	92-94	16 361 3010 (3VLF63310000)	16 361 6010 (3VLF63340200)
50	Cw Booster Naked	03		16 361 6010 (3VLF63340200)
50	Cw Booster Spirit	96-98	16 361 3010 (3VLF63310000)	16 361 6010 (3VLF63340200)
50	Cw Booster Spirit (ITA)	99	16 361 3010 (3VLF63310000)	16 361 6010 (3VLF63340200)
50	Cw Booster Spirit (ITA)	00	16 361 3010 (3VLF63310000)	16 361 6010 (3VLF63340200)

CC	MODELLO MODEL	ANNI YEARS	STARTER SUPERIORE STARTER UPPER CABLE	STARTER INFERIORE STARTER LOWER CABLE
50	Cw Booster Spirit Eu2	02	16 361 3010 (3VLF63310000)	16 361 6010 (3VLF63340200)
50	Cw Booster Spirit Eu2	03	16 361 3010 (3VLF63310000)	16 361 6010 (3VLF63340200)
50	Cw L Booster	01-03	16 361 3010 (3VLF63310000)	16 361 6010 (3VLF63340200)
50	Cw L Booster Spirit	03	16 361 3010 (3VLF63310000)	16 361 6010 (3VLF63340200)
50	Cw R Booster Road (ITA)	94-95	16 361 3010 (3VLF63310000)	16 361 6010 (3VLF63340200)
50	Cw Rs Booster Ng	01-02		16 361 6010 (3VLF63340200)
50	Cw Rs Booster Ng	03		16 361 6010 (3VLF63340200)
50	Cw Rs Booster Ng (ITA)	95-98		16 361 6010 (3VLF63340200)
50	Cw Rs Booster Ng (ITA)	99		16 361 6010 (3VLF63340200)
50	Cw Rs Booster Ng Eu1	99-00		16 361 6010 (3VLF63340200)
50	Cw Rsp Booster Rocket (ITA)	97-98		16 361 6010 (3VLF63340200)
50	Cw Rsx Booster Track (ITA)	96-98		16 361 6010 (3VLF63340200)
50	Cw Sp Booster Spirit Eu2	02	16 361 3010 (3VLF63310000)	16 361 6010 (3VLF63340200)
50	Ew Stunt	00-02		16 361 6010 (3VLF63340200)
50	Yn R Ovetto (Che- ITA)	97-01	16 361 3030 (5ADF63310000)	
50	Yq Nitro	01-02		16 361 6010 (3VLF63340200)
50	Yq Nitro	04		16 361 6010 (3VLF63340200)
50	Yq Nitro (ITA)	97-98		16 361 6010 (3VLF63340200)
50	Yq Nitro (ITA)	99-00		16 361 6010 (3VLF63340200)
100	Yn Ovetto	00-02	16 361 3030 (5ADF63310000)	
YAMAHA				
50	Bw's Bump	97-98		16 361 6010 (3VLF63340200)
50	Bw's Naked	03		16 361 6010 (3VLF63340200)
50	Bw's Next Generation	97-98		16 361 6010 (3VLF63340200)
50	Bw's Next Generation	99		16 361 6010 (3VLF63340200)
50	Bw's Next Generation	01-02		16 361 6010 (3VLF63340200)
50	Bw's Next Generation	03		16 361 6010 (3VLF63340200)



CC	MODELLO MODEL	ANNI YEARS	STARTER SUPERIORE STARTER UPPER CABLE	STARTER INFERIORE STARTER LOWER CABLE
50	Bw's Next Gene- ration	04-06		16 361 6010 (3VLF63340200)
50	Bw's Next Generation Cat.	99-00		16 361 6010 (3VLF63340200)
50	Bw's Original	97-98	16 361 3010 (3VLF63310000)	16 361 6010 (3VLF63340200)
50	Bw's Original	99	16 361 3010 (3VLF63310000)	16 361 6010 (3VLF63340200)
50	Bw's Original	99-00	16 361 3010 (3VLF63310000)	16 361 6010 (3VLF63340200)
50	Bw's Original	01-02	16 361 3010 (3VLF63310000)	16 361 6010 (3VLF63340200)
50	Bw's Original Eu2	03	16 361 3010 (3VLF63310000)	16 361 6010 (3VLF63340200)
50	Bw's R	01	16 361 3010 (3VLF63310000)	16 361 6010 (3VLF63340200)
50	Cw Bw's Original Eu2	02	16 361 3010 (3VLF63310000)	16 361 6010 (3VLF63340200)
50	Cw L Bw's	03	16 361 3010 (3VLF63310000)	16 361 6010 (3VLF63340200)
50	Cw Rs Spy	95-98		16 361 6010 (3VLF63340200)
50	Cw Sp Bw's Original Eu2	02	16 361 3010 (3VLF63310000)	16 361 6010 (3VLF63340200)
50	Ew Slider	00-02		16 361 6010 (3VLF63340200)
50	Yn R Neo's	97-01	16 361 3030 (5ADF63310000)	
50	Yq Aerox	97-98		16 361 6010 (3VLF63340200)
50	Yq Aerox	01-02		16 361 6010 (3VLF63340200)
50	Yq Aerox	04		16 361 6010 (3VLF63340200)
50	Yq Aerox	05		16 361 6010 (3VLF63340200)
50	Yq Aerox	06		16 361 6010 (3VLF63340200)
50	Yq Aerox	07		16 361 6010 (3VLF63340200)
50	Yq Aerox	08		16 361 6010 (3VLF63340200)
50	Yq Aerox R	99		16 361 6010 (3VLF63340200)
50	Yq Aerox R	99-00		16 361 6010 (3VLF63340200)
100	Yn Neo's	99-02	16 361 3030 (5ADF63310000)	

The background of the entire page is a repeating pattern of various mechanical and automotive icons in a light gray color. These icons include a motorcycle, a battery with a lightning bolt, a wrench and screwdriver, a piston, a gear, a bolt, a nut, a tire, a wheel, and a bolt with a nut. The icons are arranged in a grid-like fashion, creating a textured, industrial feel.

RMS

YOUR BEST PARTNER

▶ CAVI TRASMISSIONE

TRANSMISSION CABLES



TRASMISSIONI VESPA

VESPA TRANSMISSIONS

KIT TRASMISSIONI GUAINE GRIGIE E CAVI COMPLETO VESPA - VESPA TRANSMISSIONS KIT

MODELLO MODEL	CC	CODICE RMS RMS CODE	CODICE A BARRE BARCODE	CODICE ORIGINALE - OEM CODE						
				GAS THROTTLE	CAMBIO GEAR	FRIZIONE CLUTCH	FRENO ANT. FRONT BRAKE	FRENO POST. REAR BRAKE	STARTER CHOKE	CONTAKM SPEEDOMETER
Vespa	50-90	16 362 0010		139403	139402	192681	174164	174701	098221	071059
Vespa	50-90	16 362 0190		139403	139402	192681	174164	174701	098221	-
Vespa Special	50	16 362 0220		139403	139402	192681	174164	191804	098221	071059
Vespa Primavera Et3	125	16 362 0020		139403	139402	192681	174164	174701	152391	071059
Vespa GL-Sprint	125-150	16 362 0030		139403	139402	192681	174164	174701	092370	099011
Vespa Px 1 Serie Tamburo	125-150-200	16 362 0040		139403	139402	192681	174164	174701	092370	174161
Vespa Px Arcobaleno	125-150-200	16 362 0050		139403	139402	192681	179642	191804	104292	179271
Vespa Px Disco	125-150-200	16 362 0060		139403	139402	192681	-	191804	104292	563796
Vespa Px 2 Serie	125-150-200	16 362 0170		139403	139402	192681	174164	191804	092370	174161

KIT TRASMISSIONI GUAINE IN TEFLON® E CAVI COMPLETO VESPA - VESPA TEFLON® TRANSMISSION KIT

MODELLO MODEL	CC	CODICE RMS RMS CODE	CODICE A BARRE BARCODE	CODICE ORIGINALE - OEM CODE						
				GAS THROTTLE	CAMBIO GEAR	FRIZIONE CLUTCH	FRENO ANT. FRONT BRAKE	FRENO POST. REAR BRAKE	STARTER CHOKE	CONTAKM SPEEDOMETER
Vespa	50-90	16 362 0070		139403	139402	192681	174164	174701	098221	071059
Vespa	50-90	16 362 0200		139403	139402	192681	174164	174701	098221	-
Vespa Special	50	16 362 0230		139403	139402	192681	174164	191804	098221	071059
Vespa Primavera Et3	125	16 362 0080		139403	139402	192681	174164	174701	152391	071059
Vespa GL-Sprint	125-150	16 362 0090		139403	139402	192681	174164	174701	092370	099011
Vespa Px 1 Serie	125-150-200	16 362 0100		139403	139402	192681	174164	174701	092370	174161
Vespa Px Arcobaleno	125-150-200	16 362 0110		139403	139402	192681	179642	191804	104292	179271
Vespa Px Freno Disco	125-150-200	16 362 0120		139403	139402	192681	-	191804	104292	563796
Vespa Px 2 Serie	125-150-200	16 362 0180		139403	139402	192681	174164	191804	092370	174161



TRASMISSIONI STARTER - CHOKE TRANSMISSIONS



CC	MODELLO - MODEL	CODICE RMS - RMS CODE	RIF. ORIGINALE - OEM CODE
50	Pk-N-R-Special	16 361 0040	098221
90	Ss-Sprint	16 361 0040	098221
125	Pk	16 361 0040	098221
125	Et3-Primavera	16 361 0060	152391
150	Sprint '59-Gl'64-'65	16 361 0120	092370
160	Gs	16 361 0120	092370
180	Ss	16 361 0120	092370
200	Rally	16 361 0120	092370
125-150-200	Px Tamburo/Drum	16 361 0120	092370
125-150-200	Px Arcobaleno Px Freno A Disco/Disc	16 361 0130	104292



TRASMISSIONI CONTACHILOMETRI - SPEEDOMETER TRANSMISSIONS



CC	MODELLO - MODEL	CODICE RMS - RMS CODE	RIF. ORIGINALE - OEM CODE
50	Ciao	16 363 0990	187423
50	N - R - Special	16 363 1010	071059
50	Pk	16 363 1040	195407
50	Hp	16 363 1030	266231
90	Ss -Sprint	16 363 1010	071059
125	Primavera	16 363 1010	071059
125	Primavera Att. Rapido	16 363 1960	183582
125	Et3	16 363 1010	071059
125	Pk	16 363 1040	195407
125	FL2	16 363 1030	266231
150	Sprint	16 363 1900	099011
150	GL 64	16 363 1910	097713
150	65	16 363 1920	098641
150	59	16 363 1930	-
160	Gs	16 363 1940	057045
180	Ss	16 363 1050	090525
200	Rally	16 363 1950	090525
125-150-200	Px 1° Serie	16 363 1050	174261
125-150-200	Px Arcobaleno	16 363 1060	179271
125-150-200	Px Freno a Disco	16 363 1250	563796
125-150-200	Cosa 1 - 2	16 363 1070	229358
125-150-200	Lambretta Li 3° Serie	16 363 1970	00611068
125-150-200	Lambretta DL	16 363 1980	00611125



CAVI VESPA - VESPA CABLES

CONFEZIONE 1 Pz - 1 PC. PACK

CC	MODELLO MODEL	CAVO GAS NIPPO PICCOLO THROTTLE CABLE SMALL NIPPLE	CAVO GAS BARILOTTO THROTTLE CABLE	CAVO FRIZIONE CLUTCH CABLE	CAVO CAMBIO SHIFT CABLE	CAVO FRENO POST. REAR BRAKE CABLE
50	N-R-Special	16 351 0011 (Ø 1.2 x 2000 mm) 16 351 0091 (Ø 1.2 x 3200 mm)	16 351 0021 (Ø 1.2 x 2000 mm)	16 351 4011 (Ø 1.9 x 2500 mm)	16 351 6011 (Ø 1.6 x 2000 mm)	16 351 8021 (Ø 3 x 1000 mm)
50	Pk FL				16 351 6020	16 351 8021 (Ø 3 x 1000 mm)
50	Hp			16 351 4021 (Ø 1.9 x 2000 mm)	16 358 0010 Trasmissione Completa Complete Transmission	16 351 8021 (Ø 3 x 1000 mm)
50-125	Pk			16 351 4021 (Ø 1.9 x 2000 mm)		16 351 8021 (Ø 3 x 1000 mm)
90	Ss-Srint	16 351 0011 (Ø 1.2 x 2000 mm) 16 351 0091 (Ø 1.2 x 3200 mm)	16 351 0021 (Ø 1.2 x 2000 mm)	16 351 4011 (Ø 1.9 x 2500 mm)	16 351 6011 (Ø 1.6 x 2000 mm)	16 351 8021 (Ø 3 x 1000 mm)
125	Primavera	16 351 0011 (Ø 1.2 x 2000 mm) 16 351 0091 (Ø 1.2 x 3200 mm)	16 351 0021 (Ø 1.2 x 2000 mm)	16 351 4011 (Ø 1.9 x 2500 mm)	16 351 6011 (Ø 1.6 x 2000 mm)	16 351 8021 (Ø 3 x 1000 mm)
125	T5	16 351 0011 (Ø 1.2 x 2000 mm) 16 351 0091 (Ø 1.2 x 3200 mm)	16 351 0021 (Ø 1.2 x 2000 mm)	16 351 4011 (Ø 1.9 x 2500 mm)		16 355 0090 Trasmissione Freno Ant. Front BrakeCable
150	'59-Sprint GL '64-'65	16 351 0011 (Ø 1.2 x 2000 mm) 16 351 0091 (Ø 1.2 x 3200 mm)	16 351 0021 (Ø 1.2 x 2000 mm)	16 351 4011 (Ø 1.9 x 2500 mm)	16 351 6011 (Ø1.6x2000mm)	
160	Gs	16 351 0011 (Ø 1.2 x 2000 mm) 16 351 0091 (Ø 1.2 x 3200 mm)	16 351 0021 (Ø1.2x2000mm)	16 351 4011 (Ø1.9x2500mm)	16 351 6011 (Ø1.6x2000mm)	
180	Ss	16 351 0011 (Ø 1.2 x 2000 mm) 16 351 0091 (Ø 1.2 x 3200 mm)	16 351 0021 (Ø 1.2 x 2000 mm)	16 351 4011 (Ø 1.9 x 2500 mm)	16 351 6011 (Ø 1.6 x 2000 mm)	
125-150-200	Px	16 351 0011 (Ø 1.2 x 2000 mm) 16 351 0091 (Ø 1.2 x 3200 mm)	16 351 0021 (Ø 1.2 x 2000 mm)	16 351 4011 (Ø 1.9 x 2500 mm)	16 351 6011 (Ø 1.6 x 2000 mm)	16 351 8021 (Ø 3 x 1000 mm)

CONFEZIONE 50 Pz - 50 PCS.PACK

CAVO GAS A NIPPLES THROTTLE CABLE	CAVO GAS A BARILOTTO THROTTLE CABLE	CAVO FRIZIONE CLUTCH CABLE	CAVO CAMBIO SHIFT CABLE	CAVO FRENO POST. REAR BRAKE CABLE
16 351 0019 Conf. 50pz. - 50 Pcs. Pack (Ø 1.2 x 2000 mm) Nipplo Piccolo - Small Nipple	16 351 0029 Conf. 50pz. - 50 Pcs. Pack (Ø 1.2 x 2000 mm)	16 351 4019 Conf. 50pz. - 50 Pcs. Pack (Ø 1.9 x 2500 mm)	16 351 6019 Conf. 50pz. - 50 Pcs. Pack (Ø 1.6 x 2000 mm)	16 351 8029 (Ø 3 x 1000 mm)
16 351 4029 Conf. 50pz. - 50 Pcs. Pack (Ø 1.9 x 2000 mm)				



KIT TRASMISSIONI CICLOMOTORI PIAGGIO
TRANSMISSION KIT PIAGGIO MOPED

16 362 0130 

Colore grigio - Gray color

Ciao Sc

Trasmissione gas - *Throttle transmission*

Trasmissione freno anteriore - *Front brake transmission*

Trasmissione freno posteriore - *Rear brake transmission*

Trasmissione freno decompressore - *Decompressor transmission*



16 362 0140 

Colore grigio - Gray color

Ciao Px

Trasmissione gas - *Throttle transmission*

Trasmissione freno anteriore - *Front brake transmission*

Trasmissione freno posteriore - *Rear brake transmission*

Trasmissione freno decompressore - *Decompressor transmission*



16 362 0150 

Colore nero - Black color

Ciao Px

Trasmissione gas - *Throttle transmission*

Trasmissione freno anteriore - *Front brake transmission*

Trasmissione freno posteriore - *Rear brake transmission*

Trasmissione freno decompressore - *Decompressor transmission*



16 362 0160 

Colore nero - Black color

Si - Si FL2

Trasmissione gas - *Throttle transmission*

Trasmissione freno anteriore - *Front brake transmission*

Trasmissione freno posteriore - *Rear brake transmission*

Trasmissione freno decompressore - *Decompressor transmission*



TRASMISSIONI MICROVETTURE - MICROCAR TRANSMISSIONS

CC	MODELLO - MODEL	CONTACHILOMETRI - SPEEDOMETER
-	Ligier Nova	16 363 1750 - (980622)



12 185 8010 

MORSETTO CON VITE LATERALE
CLAMPS WITH SIDE SCREW
per cavo frizione Ø 1,9
for clutch cable Ø 1,9
Conf. 50 pz. - 50 Pcs Packing



12 185 8020 

MORSETTO CON VITE LATERALE
CLAMPS WITH SIDE SCREW
per cavo frizione Ø 2,5
for clutch cable Ø 2,5
Conf. 50 pz. - 50 Pcs Packing

12 185 8030 

MORSETTO CON VITE LATERALE
CLAMPS WITH SIDE SCREW
per cavo frizione Ø 3
for clutch cable Ø 3
Conf. 50 pz. - 50 Pcs Packing

12 185 8040 

MORSETTO CAVO GAS (tipo magura)
THROTTLE CABLE CLAMPS
Conf. 50 pz. - 50 Pcs Packing



12 185 8050 

MORSETTO CAVO GAS (super pratic)
THROTTLE CABLE CLAMPS
Conf. 50 pz. - 50 Pcs Packing



12 185 8060 

MORSETTO CILINDRICO CAVO GAS
al carburatore Vespa
THROTTLE CABLE CLAMPS
Conf. 50 pz. - 50 Pcs Packing



12 185 8120 

MORSETTO REGOLATORE FILO FRENO
FRIZIONE
TERMINAL ADJUSTING SCREW
applicazioni varie
Conf. 10 pz. - 10 Pcs Packing



12 185 8070 

MORSETTO CAVO CAMBIO VESPA
Lunghezza 11 mm
GEAR CABLE CLAMPS 11 MM
Conf. 50 pz. - 50 Pcs Packing
(R.O. 153198)



12 185 8080 

MORSETTO CAVO CAMBIO
Lunghezza 16 mm
GEAR CABLE CLAMPS 16 MM
Ape • TM P703 • P703V Diesel
Car • Max diesel • Poker diesel
MP P501 • P601 78>2001
Conf. 50 pz. - 50 Pcs Packing
(R.O. 153513)



12 185 8170 

BARILOTTO LEVA FRENO AL MANUBRIO
PIVOT PINS FOR BRAKE LEVER
applicazioni varie
Conf. 50 pz. - 50 Pcs Packing



12 185 8130 

REGISTRO Ø 5 applicazioni varie mm 20
ADJUSTING SCREW
Conf. 50 pz. - 50 Pcs Packing
(R.O. 090527 - 020105)



12 185 8150 

REGISTRO Ø 8 applicazioni varie
ADJUSTING SCREW
Conf. 50 pz. - 50 Pcs Packing



12 185 8210 

BUSOLETTA PER GUAINA Ø 4,5
CABLE AND CENTRING BUSHES Ø 4,5
Conf. 200 pz. - 200 Pcs Packing





MORSETTI
CLAMPS

12 185 8180 

CAPOGUAINA PER GUAINA Ø 5,5 x 9,5
CABLE ENDS Ø 5,5 x 9,5
Conf. 200 pz. - 200 Pcs Packing

12 185 8200 

CAPOGUAINA PER GUAINA Ø INTERNO 7 x 11
CABLE ENDS INSIDE Ø 7 x 11
Conf. 200 pz. - 200 Pcs Packing

12 185 8240 

CAPOGUAINA PER GUAINA-Ø 4,5 NICHELATI
NICHEL - PLATED CABLE ENDS Ø 4,5
Conf. 200 pz. - 200 Pcs Packing

12 185 8190 

CAPOGUAINA PER GUAINA Ø INTERNO 6 x 10
CABLE ENDS INSIDE Ø 6 x 10
Conf. 200 pz. - 200 Pcs Packing



12 186 0323 

KIT SERRACAVO FRENO ANTERIORE
FRONT CABLE PLATE
Vari Modelli Vespa - *Various Vespa Models*
(R.O. 177271)



12 186 0343 

NIPPLIO
NIPPLE
Vari Modelli Vespa - *Various Vespa Models*
(R.O. 018699)





RINVII CONTAKILOMETRI COMPLETI - COMPLETE SPEEDOMETER GEARS

16 369 0110

PIAGGIO 50-100: Zip 2T-4T
(R.O. 56143R)



16 369 0120

PIAGGIO 50-125-150-200-250-300-400-500
(R.O. 56147R)



16 369 0130

PIAGGIO 50-125: Typhoon 2T-4T 10-12
(R.O. 56434R)



MODELLO - MODEL	CC	ANNI YEARS	CODICERMS RMS CODE	RIF. ORIGINALE ORIGINAL NUMBER
PIAGGIO				
Fly 2T	50	05-07	16 369 0120	56147R
Fly 2T	50	10-11	16 369 0120	56147R
Fly 4T	50	05-07	16 369 0120	56147R
Fly 4T & 25- 30 Km/h	50	08-11	16 369 0120	56147R
Fly 4T 2V	50	13-13	16 369 0140	CM075505
Fly 4T 2V 25- 30Km/h	50	12-14	16 369 0140	CM075505
Fly 4T 4V	50	12-13	16 369 0140	CM075505
Fly 4T Motore Chn	50	06-07	16 369 0120	56147R
Liberty 2T	50	06-08	16 369 0120	56147R
Liberty 2T Rst	50	04-04	16 369 0120	56147R
Liberty 2T Sport	50	06-08	16 369 0120	56147R
Liberty 4T	50	05-08	16 369 0120	56147R
Liberty 4T Delivery-Single	50	10-12	16 369 0120	56147R
Liberty 4T Delivery Tnt	50	09-09	16 369 0120	56147R
Liberty 4T Ptt-Double	50	09-12	16 369 0120	56147R
Liberty 4T Ptt (Deu)	50	07-12	16 369 0120	56147R
Liberty 4T Rst	50	04-04	16 369 0120	56147R
Liberty 4T Sport	50	06-08	16 369 0120	56147R
Liberty Moc 2T & Elle	50	09-13	16 369 0120	56147R
Liberty Moc 4T & Elle	50	09-13	16 369 0120	56147R
Nrg Extreme	50	99-00	16 369 0120	56147R
Nrg Mc3	50	01-04	16 369 0120	56147R
Typhoon 2T Eu2	50	10-12	16 369 0130	56434R
Typhoon 2T Eu3 Ch	50	11-11	16 369 0130	56434R
Zip	50	00-04	16 369 0110	56143R
Zip 2T	50	08-13	16 369 0110	56143R
Zip 4T	50	00-13	16 369 0110	56143R
Fly 4T	100	06-08	16 369 0120	56147R
Zip 4T	100	06-10	16 369 0110	56143R
Beverly Eu3	125	07-08	16 369 0120	56147R
Beverly Eu3 Mic	125	07-07	16 369 0120	56147R
Beverly Eu3 Sport	125	07-08	16 369 0120	56147R
Beverly Rst	125	04-07	16 369 0120	56147R
Beverly Tourer Eu3	125	07-10	16 369 0120	56147R
Carnaby	125	07-10	16 369 0120	56147R
Fly	125	05-07	16 369 0120	56147R
Fly 4T 3V IE E3 Dt	125	13-13	16 369 0140	CM075505
Fly 4T 3V IE Eu3 Lem	125	12-13	16 369 0140	CM075505
Fly Eu3	125	07-07	16 369 0120	56147R
Fly Eu3	125	08-11	16 369 0120	56147R
Liberty 4T	125	06-07	16 369 0120	56147R
Liberty 4T 2V Eu3	125	09-12	16 369 0120	56147R
Liberty 4T 2V IE Ptt	125	12-12	16 369 0120	56147R
Liberty 4T Eu3	125	07-08	16 369 0120	56147R
Liberty 4T Eu3 Delivery	125	07-12	16 369 0120	56147R
Liberty 4T Sport Eu3	125	06-08	16 369 0120	56147R
Liberty Rst	125	04-05	16 369 0120	56147R
Liberty Rst Ptt	125	05-11	16 369 0120	56147R
Liberty Sport	125	06-06	16 369 0120	56147R

16 369 0140

PIAGGIO 50-125: Fly 4T 4V - 3V 12-14
(R.O. CM075505)



MODELLO - MODEL	CC	ANNI YEARS	CODICE RMS RMS CODE	RIF. ORIGINALE ORIGINAL NUMBER
Skipper 4T	125	00-02	16 369 0120	56147R
Skipper Lx	125	98-99	16 369 0120	56147R
Super Hexagon Gtx 12	125	01-02	16 369 0120	56147R
Typhoon 4T 2V Eu3	125	10-11	16 369 0130	56434R
Fly	150	05-07	16 369 0120	56147R
Fly Eu3	150	08-11	16 369 0120	56147R
Liberty 4T Eu3	150	08-08	16 369 0120	56147R
Liberty 4T Sport Eu3	150	08-08	16 369 0120	56147R
Liberty Moc 4T Eu3	150	09-13	16 369 0120	56147R
Carnaby	200	07-08	16 369 0120	56147R
Liberty	200	06-06	16 369 0120	56147R
Liberty 4T Eu3	200	06-08	16 369 0120	56147R
Liberty 4T Sport Eu3	200	06-07	16 369 0120	56147R
Liberty Rst	200	04-04	16 369 0120	56147R
Liberty Sport	200	06-06	16 369 0120	56147R
Beverly	250	06-07	16 369 0120	56147R
Beverly Cruiser	250	07-09	16 369 0120	56147R
Beverly Eu3 Mic	250	07-07	16 369 0120	56147R
Beverly IE Eu3	250	06-08	16 369 0120	56147R
Beverly Rst	250	04-05	16 369 0120	56147R
Beverly Sport	250	06-08	16 369 0120	56147R
Beverly Tourer Eu3	250	08-09	16 369 0120	56147R
Carnaby	250	08-08	16 369 0120	56147R
Beverly Tourer Eu3	300	09-10	16 369 0120	56147R
Carnaby Cruiser	300	09-12	16 369 0120	56147R
Beverly Eu3	400	06-07	16 369 0120	56147R
Beverly Tourer Eu3	400	08-10	16 369 0120	56147R
Beverly	500	02-04	16 369 0120	56147R
Beverly	500	05-06	16 369 0120	56147R
Beverly Cruiser	500	07-12	16 369 0120	56147R
Beverly Eu3	500	06-08	16 369 0120	56147R

PIGNONI RINVIO CONTACHILOMETRI - CAVI GUAINA

SPEEDOMETER PINIONS - CABLES



MODELLO MODEL	CODICE RMS RMS CODE	CODICE A BARRE BARCODE	COD. ORIGINALE ORIGINAL CODE
HONDA: 125-150 Sh	16 369 0100		Per Rinvio 44800KPR900
PIAGGIO: Vespa Px 125-150-200 Vnx, VLX, Vsx	16 369 0030		174048
PIAGGIO: Vespa Pxe 125-150-200 Vnx 2, VLX 2, Vsx 2	16 369 0040		177508
PIAGGIO: Vespa 50-90-125 Primavera, V5a 2T, V5b 1T, V5b 3T, V9a1, Vma 2, Vmb 1	16 369 0050		151614
PIAGGIO: Vespa Pk 50-125 V5x 1T, V5x 2T, V5s 1T, Vmx 1T, Vmx 5t	16 369 0060		217128
PIAGGIO: Vespa 150 Super Vbc 1T	16 369 0070		93535
PIAGGIO: Vespa 150 Sprint VLB-VLB 1T-VLA	16 369 0080		98652
PIAGGIO: Vespa 50-90-125 Primavera-Et3 V5a 1T-V5sa 1T-V5ss-V5b1/2/3-V9a 1T-V9ss-Vma 1T/2T-Vmb 1T	16 369 0090		151615

CAVI MOTO - MOTORCYCLE CABLES

CAVI MOTO TIPO SVEDESI - MOTORCYCLES CABLE SWEDISH TYPE		CAVI CICLOMOTORE MOTO - MOPED AND MOTORCYCLE CABLES WIRE		
GAS - THROTTLE	FRIZIONE - CLUTCH	GAS - THROTTLE	FRIZIONE - CLUTCH	FRENO - BRAKE
 16 351 0081 (cavo int. 1.24 x 2000) Testina Cilindrica Ø 2,73 x 2,96	 16 351 4111 (cavo int. 1.86 x 2200) Barilotto (Ø 7,86 x 7,82)	 16 351 0031 (cavo int. 1.2x1300)	 16 351 4011 (cavo int. 1.9x2000)	 16 351 8030 (cavo int. 1.9x1800)
	 16 351 4121 (cavo int. 1,86 x 220) Nottolino movib.		 16 351 4050 (cavo int. 2.5x2000)	
			 16 351 4041 (cavo int. 2.5x1600)	

GUAINA CON SPIRALE IN ACCIAIO TONDO (TIPO ITALIA) - OUTER CABLE ROUND WIRE (ITALIAN TYPE)

CODICE RMS RMS CODE	CODICE A BARRE BARCODE	COLORE COLOUR	MISURA SIZE	FORO INTERNO INSIDE HOLE mm	DIAMETRO ESTERNO OUTSIDE DIAMETER mm	DIAMETRO ESTERNO CON RIVESTIMENTO OUTSIDE HOLE WITH RUBBER mm
16 353 0400		nero - black	50/mtrs roll	2,5	4,5	5,2
16 353 0401		grigio - gray	50/mtrs roll	2,5	4,5	5,2
16 353 0411		grigio millerighe gray grooved	50/mtrs roll	2,5	4,5	5,2
16 353 0500		nero - black	50/mtrs roll	3	5	5,8
16 353 0600		nero - black	25/mtrs roll	3,5	6	7
16 353 0700		nero - black	25/mtrs roll	4,2	7	8



GUAINA A FILO PIATTO CON INSERTO IN PVC - OUTER CABLE FLAT TYPE

16 353 0510		nero - black	50/mtrs roll	2,00/2,10	3,95/4,00	4,91/5,00
-------------	--	--------------	--------------	-----------	-----------	-----------



TUBO COMANDO CAMBIO - GAS PIAGGIO VESPA
PIAGGIO VESPA THROTTLE CONTROL AND GEAR TUBE



18 404 0330 

TUBO COMANDO CAMBIO
SHIFT CONTROL

PIAGGIO 50: Vespa Special 4 marce 72
(R.O. 135935)



18 404 0380 

TUBO COMANDO CAMBIO
SHIFT CONTROL

PIAGGIO 150: Vespa GL • Sprint • Gs
VLA-VLB-VSB1T
(R.O. 090538)



18 404 0390 

TUBO COMANDO CAMBIO
SHIFT CONTROL

PIAGGIO 125: Vespa Px 30 anni 07
125-150-200: Vespa Px Arcobaleno 84
Freno a disco - *Brake disc*
(R.O. 219356)



18 408 0290 

TUBO COMANDO GAS
THROTTLE CONTROL

PIAGGIO 50: Vespa Rush N • FL 88-90
50-125-150: Vespa Px • Pe • Pk • Pk XL • Rush
• N 95-99
125-150-200: Vespa Px Arcobaleno 84
(R.O. 139778)



18 404 0610 

PULEGGIA CAMBIO - GEAR PULLEY

PIAGGIO 50-125: Pxe Arcobaleno • Pk
125-150-200: Vespa PX
125: T5
VNX - VLX - VSX - VNX2 - VLX2 - VSX2
(R.O. 139796)



18 404 0620 

PULEGGIA GAS - THROTTLE GEAR

PIAGGIO 50-125: Pxe Arcobaleno • Pk
125-150-200: Vespa PX
125: T5
VNX - VLX - VSX - VNX2 - VLX2 - VSX2
(R.O. 139797)



18 404 0673 

BUSSOLA CAVO - BUSH

PIAGGIO 125-150-200: Vespa Px • Pxe •
Arcobaleno
VNX-VLX-VSX-VNX2-VLX2-VSX2
(R.O. 133912)



18 404 0683 

BUSSOLA CAVO - BUSH

PIAGGIO 125-150-200: Vespa Px • Pxe
Arcobaleno
VNX-VLX-VSX-VNX2-VLX2-VSX2
(R.O. 133913)







CAVI TRASMISSIONI APE
APE TRANSMISSION CABLES

CAVI GAS APE - THROTTLE CABLES					
	CODICE CODE	OEM	MODELLO MODEL	CC	ANNO YEAR
 1,2x3200	16 351 0041	118307	Ape FL-FL2	50	89-95
			Ape FL3-Europa		96-99
			Ape P		80-85
			Ape Tm P		85-89
 1,2x3200	16 351 0051	1,2x3200	Ape Mp 501-601	220	
 	16 351 0060		Ape Mp 501-601	220	
 	16 351 0070		Ape P602 Mix	220	
CAVI FRIZIONE - CLUTCH CABLES					
	CODICE - CODE	OEM	MODELLO - MODEL	CC	ANNO YEAR
 1,9x2800	16 351 4061	118313	Ape Tm P	50	85-89
			Ape Rst Mix		99-03
			Ape P		80-85
			Ape Mix 2 tempi		98-08
			Ape FL3-Europa		96-99
			Ape FL- FL2		89-95
 2,5x3000	16 351 4090	136507	Ape Car P2-P3	220	78-85



 1,9x3000	16 351 4071	1,9x3000	Ape P 602	220	82-83
	16 351 4101		Ape Tm P703	220	84-05
			Ape P 703 V		84-05
			Ape FL2		84-05
			Ape Tm P 602		82-83

CAVI CAMBIO - GEAR SHIFT CABLES

	CODICE - CODE	OEM	MODELLO - MODEL	CC	ANNO YEAR
	16 351 6031		Ape FL-FL2	50	89-95
			Ape FL3-Europa		96-99
			Ape P		80-85
			Ape Tm P		85-89
 1,6x3000	16 351 6041		Ape Tm P 602	220	82-83
	16 351 6050	177920	Ape Tm P 602	220	82-83
			Ape P 703	420	87-04
			Ape P 703 V Diesel		87-04

CAVI STARTER - STARTER CABLES

	CODICE - CODE	OEM	MODELLO - MODEL	CC	ANNO YEAR
	16 351 2010	214168	Ape Tm P703	220	84-05
			Ape P 703 V		84-05
			Ape P 703 FL2		84-05
			Ape Tm P602		82-83
			Ape Tm		09-15
			Ape Mp P501		09-15
			Ape Mp P601		78-96



CAVI TRASMISSIONI APE
APE TRANSMISSION CABLES

TRASMISSIONI GAS - GAS TRANSMISSIONS					
	CODICE - CODE	OEM	MODELLO - MODEL	CC	ANNO YEAR
	16 359 0630	177128	Ape P 602 Versione manubrio	220	82-83
			Ape P 703		84-05
			Ape P 703 V		84-05
			Ape P 703 FL2		84-05
TRASMISSIONI FRIZIONE - CLUTCH TRANSMISSIONS					
	CODICE - CODE	OEM	MODELLO - MODEL	CC	ANNO YEAR
	16 357 0020	177150	Ape P 602	220	82-83
			Ape P 703		84-05
			Ape P 703 V		84-05
			Ape P 703 FL2		84-05
	16 357 0040	266494	Ape Poker Benzina	420	93-93
			Ape Poker Diesel		93-97
	16 357 0060	228715	Ape Tm P 703	420	87-04
			Ape P 703 V Diesel		87-04



TRASMISSIONI CAMBIO - CABLES TRANSMISSIONS					
	CODICE - CODE	OEM	MODELLO - MODEL	CC	ANNO YEAR
	16 358 0020	197097	Ape Tm	220	09-15
			Ape Tm P703		84-05
			Ape P703 V		84-05
			Ape P 703 FL2		84-05
	16 358 0040	228712	Ape Tm Diesel LCS	420	05-12
			Ape Tm P703		87-04
			Ape P 703 V		87-04
			Ape P 703 Diesel		87-04
TRASMISSIONI STARTER - STARTER TRANSMISSIONS					
	CODICE - CODE	OEM	MODELLO - MODEL	CC	ANNO YEAR
	16 361 0080	118456	Ape P	50	80-85
	16 361 0110	194821	Ape FL2	50	89-95
			Ape FL3 Europa		96-99
			Ape Rst Mix		99-03
TRASMISSIONI SDOPPIATORE MISCELATORE - SPLITTER MIXER TRANSMISSIONS					
	CODICE - CODE	OEM	MODELLO - MODEL	CC	ANNO YEAR
	16 359 5190	567104	Ape	50	09-15
			Ape Mix 2 tempi		98-08
			Ape Rst Mix		99-03



CAVI TRASMISSIONI APE
APE TRANSMISSION CABLES

	16 359 5120	133441	Ape Mp 501 1 serie	220	78-96
			Ape P 601		78-96
	16 359 5130	224979	Ape Car P2-P3 2 Serie	220	78-85
			Ape Mp 501		78-96
			Ape P 601		78-96
			Ape Tm		09-15
			Ape Tm P 602		82-83
			Ape P 703		84-05
			Ape P 703 V		84-05
			Ape P 703 FL2		84-05
TRASMISSIONI SDOPPIATORE CARBURATORE - <i>SPLITTER CARBURATOR TRANSMISSIONS</i>					
	CODICE - CODE	OEM	MODELLO - MODEL	CC	ANNO YEAR
	16 359 7290	567103	Ape	50	09-15
			Ape Mix 2 tempi		98-08
			Ape Rst Mix		99-03
TRASMISSIONI RETROMARCIA - <i>REVERSE TRANSMISSIONS</i>					
	CODICE - CODE	OEM	MODELLO - MODEL	CC	ANNO YEAR
	16 358 5000	117309	Ape Tm P	50	85-89
			Ape P		80-85
	16 358 5010	258646	Ape Rst Mix	50	99-03
			Ape Mix 2 tempi		98-08
			Ape FL3-Europa		96-99
			Ape FL- FL2		89-95
			Ape		09-15
	16 358 5030	159693	Ape Mp 501	220	78-96
			Ape P 601		78-96



	16 358 5040	266596	Ape Tm P703	220	84-05
			Ape P 703 V		84-05
			Ape FL2		84-05
			Ape Tm		09-15
	16 358 5050	197069	Ape Tm P602	220	82-83

TRASMISSIONI FRENO A MANO - *HANDBRAKE TRANSMISSIONS*

	CODICE - CODE	OEM	MODELLO - MODEL	CC	ANNO YEAR
	16 355 5460	140247	Ape Mp P 501	220	82-83
			Ape P 601		82-83
	16 355 5470	189752	Ape Tm P703	220	84-05
			Ape P 703 V Diesel	420	87-04
			Ape Tm 602	220	82-83
	16 355 5480	214153	Ape Tm P 703	220	84-05
			Ape P 703 V	220	84-05
			Ape FL2	220	84-05
			Ape Tm P703	420	87-04
			Ape P 703 V Diesel	420	87-04
			Ape Tm P 602	220	82-83

TRASMISSIONI CONTACHILOMETRI - *SPEEDOMETER TRANSMISSIONS*

	CODICE - CODE	OEM	MODELLO - MODEL	CC	ANNO YEAR
	16 363 1080	188636	Ape	50	09-15
			Ape FL-FL2		89-95
			Ape FL3-Europa		96-99
			Ape Mix 2 tempi		98-08
			Ape P		80-85
			Ape Rst Mix		99-03
			Ape Tm P		85-89
	16 363 0850	194371	Ape Tm P 602	220	82-83
			Ape Tm		84-05
			Ape P 703 V		84-05
			Ape P 703 FL2		84-05



RMS

YOUR BEST PARTNER

▶ SPECCHI RETROVISORI SCOOTER E MOTO



*SCOOTER AND MOTO REAR
VIEW MIRRORS*

SPECCHI RETROVISORI SCOOTER
SCOOTER REAR VIEW MIRRORS



APRILIA

50: Amico • GL • GLE 93-98 • Gulliver aria - Lc 95-98 • Sr • Www • Street • Stealth Racing • Liquid Cooled • H2o Ditech e carburatore • Ditech Eu 2 93-11

125: Sr 93-01

	CODICE RMS - RMS CODE		COLORE COLOR	LATO SIDE	PASSO THREAD
	12 277 0080		Nero Black	Destro Right	-
	 R.O. AP 8201975				
	12 276 0080		Nero Black	Sinistro Left	-
	 R.O. AP 8201976				

50: Sr R 04-14

	CODICE RMS - RMS CODE		COLORE COLOR	LATO SIDE	PASSO THREAD
	12 277 0320		Nero Black	Destro Right	Fori passanti Passing holes
	 R.O. AP8202394				
	12 276 0320		Nero Black	Sinistro Left	Fori passanti Passing holes
	 R.O. AP8202395				





50: Mojito retrò 99-03 • Mx 04 • Rally 96-99 • Rx 95-06 • Scarabeo 93-14 • Sonic 98-08 • 100: Scarabeo 4T 01-14 • Scarabeo Motori Minarelli 00 • Scarabeo Motori Yamaha 00 • 125: Mojito retrò 99-01 • Mojito 03-07 • Mx 04-06 • Rx 94-10 • Sx 08-10

	CODICE RMS - RMS CODE		COLORE COLOR	LATO SIDE	PASSO THREAD
	12 276 0130				
	 12 276 0160				
	 R.O. AP8201984				
	12 185 0020		Morsetto Fissaggio Specchio Lato Destro Filetto Ø 8x1,25 		
	 R.O. AP8201986				
	12 185 0030		Morsetto Fissaggio Specchio Lato Sinistro Filetto Ø 8x1,25 		
	 R.O. AP8201987				





APRILIA



50: Mojito Custom 99-10 • 125: Mojito 03-08 • Mojito retrò Custom 99-01

	CODICE RMS - RMS CODE	COLORE COLOR	LATO SIDE	PASSO THREAD
	12 277 0870	Cromato Chromed	Destro Right	10 x 1,25 
				
	R.O. AP8202166			
	12 276 0870	Cromato Chromed	Sinistro Left	10 X 1,25 
				
R.O. AP8202170				





50: Scarabeo 2T 14 • Scarabeo 4T 4V 14

	CODICE RMS - RMS CODE	COLORE COLOR	LATO SIDE	PASSO THREAD
	12 277 2240	Nero Black	Destro Right	Ø 10
				
	R.O. CM260002			
	12 276 2240	Nero Black	Sinistro Left	Ø 10
				
R.O. CM260001				





50: Scarabeo 2T 14 • Scarabeo 4T 4V 14

	CODICE RMS - RMS CODE	COLORE COLOR	LATO SIDE	PASSO THREAD
	12 277 2360	cromato Chromed	Destro Right	Perno Ø 10 Ø 10 Pin
				
	R.O. CM260002			
	12 276 2360	cromato Chromed	Sinistro Left	Perno Ø 10 Ø 10 Pin
				
R.O. CM260001				

125: Scarabeo 99-06

	CODICE RMS - RMS CODE	COLORE COLOR	LATO SIDE	PASSO THREAD
	12 277 0290	Nero Black	Destro Right	10 X 1,25 
				
	R.O. AP8104491			
	12 276 0290	Nero Black	Sinistro Left	10 X 1,25 
				
R.O. AP8104492				





125: Sport City Cube 08-10 • Sport City Eu3 06-08 • Sport City Street 12 • Sport City 04-06 • 250: Sport City Cube 08-12 • 300: Sport City Street 12

	CODICE RMS - RMS CODE	COLORE COLOR	LATO SIDE	PASSO THREAD
	12 277 0200	Nero Black	Destro Right	8 x 1,25 
				
	R.O. CM180901			
	12 276 0200	Nero Black	Sinistro Left	8 X 1,25 
				
R.O. CM180902				





SPECCHI RETROVISORI SCOOTER
SCOOTER REAR VIEW MIRRORS

APRILIA





125: Scarabeo Rotax 99-04

 <p>E-MARK</p>	CODICE RMS - RMS CODE		COLORE COLOR	LATO SIDE	PASSO THREAD
	12 277 0090		Cromato Chromed	Destro Right	10 x 1,25 
	 R.O. AP8102835				
	12 276 0090		Cromato Chromed	Sinistro Left	10 x 1,25 
	 R.O. AP8102836				



125: Scarabeo Light 07-10 • Scarabeo Piaggio Eu3 06 • **250:** Scarabeo Light 06-08 • **300:** Scarabeo Light 09-10 • **400:** Scarabeo Light 06-08 • **500:** Scarabeo Light 06-08 • Scarabeo 03-06

 <p>E-MARK</p>	CODICE RMS - RMS CODE		COLORE COLOR	LATO SIDE	PASSO THREAD
	12 277 0230		Nero Black	Destro Right	10 x 1,25 
	 R.O. AP8104526				
	12 276 0230		Nero Black	Sinistro Left	10 x 1,25 
	 R.O. AP8104527				





125: Scarabeo Piaggio Eu3 06 • Scarabeo Rotax 99-04 • Scarabeo 03-06 • **250:** Scarabeo Light 06-08 • **400:** Scarabeo Light 06-08 • **500:** Scarabeo Light 06-08



 <p>E-MARK</p>	CODICE RMS - RMS CODE		COLORE COLOR	LATO SIDE	PASSO THREAD
	12 277 0260		Nero Black	Destro Right	10 x 1,25 
	 R.O. AP8104518				
	12 276 0260		Nero Black	Sinistro Left	10 x 1,25 
	 R.O. AP8104519				

125: Leonardo 99-04 • **250:** Leonardo 99-04

 <p>E-MARK</p>	CODICE RMS - RMS CODE		COLORE COLOR	LATO SIDE	PASSO THREAD
	12 277 0300		Nero Black	Destro Right	Foro passante Passing hole
	 R.O. AP8102866-AP8104864				
	12 276 0300		Nero Black	Sinistro Left	Foro passante Passing hole
	 R.O. AP8102867-AP8104865				

500: Atlantic 01-04

 <p>E-MARK</p> <p>snodo 360° - Junction 360°</p>	CODICE RMS - RMS CODE		COLORE COLOR	LATO SIDE	PASSO THREAD
	12 277 0240		Nero Black	Destro Right	10 X 1,25 
	 R.O. AP8104453				
	12 276 0240		Nero Black	Sinistro Left	10 X 1,25 
	 R.O. AP8104454				

-  Filetto sinistro - *Left Thread*
-  Filetto destro - *Right Thread*





SPECCHI RETROVISORI SCOOTER

SCOOTER REAR VIEW MIRRORS







DERBI

50: Boulevard 09-14 • **100:** Boulevard 4T 10-11 • **125:** Boulevard 4T Eu3 08-12 • **150:** Boulevard 4T Eu3 10

	E-MARK	CODICE RMS - RMS CODE	COLORE COLOR	LATO SIDE	PASSO THREAD
	12 277 0530	Nero <i>Black</i>			
			R.O. CM027005		
	12 276 0530	Nero <i>Black</i>		Sinistro <i>Left</i>	8 x 1,25 
			R.O. CM027004		





GENERIC

50: Ideo 50



	E-MARK	CODICE RMS - RMS CODE	COLORE COLOR	LATO SIDE	PASSO THREAD
	12 277 1590	Nero <i>Black</i>			
					
	12 276 1590	Nero <i>Black</i>	Sinistro <i>Left</i>	8 x 1,25 	
					

GILERA

50: Ice 01-05

	E-MARK	CODICE RMS - RMS CODE	COLORE COLOR	LATO SIDE	PASSO THREAD
	12 277 0940	Nero <i>Black</i>			
			R.O. CM066001		
	12 276 0940	Nero <i>Black</i>		Sinistro <i>Left</i>	10 x 1,25 
			R.O. CM066002		







50: Dna 00-02 • Dna Gp Experience 03-04 • Dna 05-07 • **125-180:** Dna 01

	E-MARK	CODICE RMS - RMS CODE	COLORE COLOR	LATO SIDE	PASSO THREAD						
	12 276 0980	Nero <i>Black</i>				Destro <i>Right</i> Sinistro <i>Left</i>	10 X 1,25 				
											
	R.O. 583111										







SPECCHI RETROVISORI SCOOTER
SCOOTER REAR VIEW MIRRORS

GILERA







50: Runner 05-11 • Runner Sp 05-12 • Storm 07 • 125: Runner 4T St 08-13 • Runner Vx 05-07 • Runner Vxr 05-11

 	CODICE RMS - RMS CODE		COLORE COLOR	LATO SIDE	PASSO THREAD
	12 277 0420				
			Nero Black	Destro Right	8 x 1,25 
	R.O. CM073002				
	12 276 0420		Nero Black	Sinistro Left	8 x 1,25 
					
R.O. CM073001					







50: Storm 94-95 • Typhoon 94-97 • 125: Typhoon 95-00

 	CODICE RMS - RMS CODE		COLORE COLOR	LATO SIDE	PASSO THREAD
	12 277 0060				
			Nero Black	Destro Right	8 x 1,25 
	R.O. 271018				
	12 276 0060		Nero Black	Sinistro Left	8 x 1,25 
					
R.O. 271022					







50: Runner 97-00 • Runner Sp 02-04 • Runner Purejet 02-04 • Runner Poggiali 02 • 125-180: Fx • Fxr 97-02 • Vx • Vxr 00-01 • 125-200: Vx • Vxr 02-04

 	CODICE RMS - RMS CODE		COLORE COLOR	LATO SIDE	PASSO THREAD
	12 277 0330				
			Nero Black	Destro Right	8 x 1,25 
	R.O. CM068002				
	12 276 0330		Nero Black	Sinistro Left	8 x 1,25 
					
R.O. CM068001					

50: Easy Moving 95-96

 	CODICE RMS - RMS CODE		COLORE COLOR	LATO SIDE	PASSO THREAD
	12 277 0700				
			Nero Black	Destro Right	8 x 1,25 
	R.O. 563496				
	12 276 0700		Nero Black	Sinistro Left	8 x 1,25 
					
R.O. 563492					

50: Stalker 97-11 • Stalker Spec Ed. 07-08

 	CODICE RMS - RMS CODE		COLORE COLOR	LATO SIDE	PASSO THREAD
	12 277 0730				
			Nero Black	Destro Right	10 x 1,25 
	R.O. 561168				
	12 276 0730		Nero Black	Sinistro Left	10 x 1,25 
					
R.O. 560897					

- Filetto sinistro - *Left Thread*
- Filetto destro - *Right Thread*

SPECCHI RETROVISORI SCOOTER

SCOOTER REAR VIEW MIRRORS



GILERA

50: Runner 08-09 • **125:** Runner 4T St 08-13 • Runner Vxr 4T St 08-11

	CODICE RMS - <i>RMS CODE</i>	COLORE COLOR	LATO SIDE	PASSO THREAD
	12 277 0750	Nero <i>Black</i>	Destro <i>Right</i>	Cilindrico Ø 10
	R.O. CM175017	Nero <i>Black</i>	Sinistro <i>Left</i>	Cilindrico Ø 10
	12 276 0750			
R.O. CM175016				

125-250: Nexus Eu 3 07-08

	CODICE RMS - <i>RMS CODE</i>	COLORE COLOR	LATO SIDE	PASSO THREAD
	12 277 0640	Nero <i>Black</i>	Destro <i>Right</i>	10x1,25
	R.O. CM175003	Nero <i>Black</i>	Sinistro <i>Left</i>	10x1,25
	12 276 0640			
R.O. CM175002				

125: Nexus Eu 3 le 08-10 • **300-500:** Nexus Eu 3 08-11

	CODICE RMS - <i>RMS CODE</i>	COLORE COLOR	LATO SIDE	PASSO THREAD
	12 277 0650	Nero <i>Black</i>	Destro <i>Right</i>	Cilindrico Ø 10
	R.O. CM175006	Nero <i>Black</i>	Sinistro <i>Left</i>	Cilindrico Ø 10
	12 276 0650			
R.O. CM175005				

50: Stalker Naked 08 • **500:** Fuoco 07-13

	CODICE RMS - <i>RMS CODE</i>	COLORE COLOR	LATO SIDE	PASSO THREAD
	12 277 0630	Nero <i>Black</i>	Destro <i>Right</i>	10x1,25
	R.O. CM175007	Nero <i>Black</i>	Sinistro <i>Left</i>	10x1,25
	12 276 0630			
R.O. CM175008				

HONDA





110: Vision

	CODICE RMS - <i>RMS CODE</i>	COLORE COLOR	LATO SIDE	PASSO THREAD
	12 277 1050	Nero <i>Black</i>	Destro <i>Right</i>	8 x 1,25
	R.O. 82210-GFM-B20	Nero <i>Black</i>	Sinistro <i>Left</i>	8 x 1,25
	12 276 1050			
R.O. 82220-GFM-B20				





SPECCHI RETROVISORI SCOOTER
SCOOTER REAR VIEW MIRRORS

HONDA





125-150: Sh 13>

	CODICE RMS - RMS CODE		COLORE COLOR	LATO SIDE	PASSO THREAD
	12 277 1130				
			Nero Black	Destro Right	8 x 1,25 
	R.O. 88210-K01-D01				
	12 276 1130		Nero Black	Sinistro Left	8 x 1,25 
					
R.O. 88220-K01-D01					





125-150: Chiocciola • @ • Nes • Sh 01-02

	CODICE RMS - RMS CODE		COLORE COLOR	LATO SIDE	PASSO THREAD
	12 277 0350				
			Nero Black	Destro Right	8 x 1,25 
	R.O. 88210-KGF-900				
	12 276 0350		Nero Black	Sinistro Left	8 x 1,25 
					
R.O. 88220-KGF-900					

125: Sh Mode 13-14

	CODICE RMS - RMS CODE		COLORE COLOR	LATO SIDE	PASSO THREAD
	12 277 1550				
			Nero Black	Destro Right	M8 
	R.O. 88210-K29-901				
	12 276 1550		Nero Black	Sinistro Left	M8 
					
R.O. 88220-K29-901					





125-150: Pcx

	CODICE RMS - RMS CODE		COLORE COLOR	LATO SIDE	PASSO THREAD
	12 277 1060				
			Nero Black	Destro Right	10 x 1,25 
	R.O. 88210-KWN-900				
	12 276 1060		Nero Black	Sinistro Left	10 x 1,25 
					
R.O. 88220-KWN-900					







HONDA



250: Jazz 01-03 • Forza 08 • 400: Silverwing 06-08 • Sw T 09-10 • 600: Silverwing abs 01-10

 <p>E-MARK</p>	CODICE RMS - RMS CODE	COLORE COLOR	LATO SIDE	PASSO THREAD
	12 277 0280	Nero Black	Destro Right	Con adattatore With adapter 10 x 1,25
				
	R.O. 88110-MFG-D00	Nero Black	Sinistro Left	Con adattatore With adapter 10 x 1,25
	12 276 0280			
				
R.O. 88120-MFG-D00				

300: Forza 13>





 <p>E-MARK</p>	CODICE RMS - RMS CODE	COLORE COLOR	LATO SIDE	PASSO THREAD
	12 277 1190	Nero Black	Destro Right	10 x 1,25 
				
	R.O. 88210-K04-930	Nero Black	Sinistro Left	10 x 1,25 
	12 276 1190			
				
R.O. 88220-K04-930				

700: Nc Integra 11-13 • 750: Nc Integra 14





 <p>E-MARK</p>	CODICE RMS - RMS CODE	COLORE COLOR	LATO SIDE	PASSO THREAD
	12 277 1100	Nero Black	Destro Right	Con adattatore With adapter 10 x 1,25
				
	R.O. 88210-MGS-D30	Nero Black	Sinistro Left	Con adattatore With adapter 10 x 1,25
	12 276 1100			
				
R.O. 88220-MGS-D30				

KYMCO

50: Kb • K12 95-00 • Fever Zx 99-00 • Zx Eu 2 03-04

 <p>E-MARK</p>	CODICE RMS - RMS CODE	COLORE COLOR	LATO SIDE	PASSO THREAD
	12 277 0370	Nero Black	Destro Right	8 x 1,25 
				
	R.O. 00152866 - 88110-KCX-9000	Nero Black	Sinistro Left	8 x 1,25 
	12 276 0370			
				
R.O. 00152867 - 88120-KCX-9000				





50: Filly 98-00 • Super 9 00-04 • Top Boy 97-00 • Yup 02-03

 <p>E-MARK</p>	CODICE RMS - RMS CODE	COLORE COLOR	LATO SIDE	PASSO THREAD
	12 277 0380	Nero Black	Destro Right	8 x 1,25 
				
	R.O. 00152500 - 88110-KEB7-E000	Nero Black	Sinistro Left	8 x 1,25 
	12 276 0380			
				
R.O. 00152521 - 88120-KEB7-E000				





SPECCHI RETROVISORI SCOOTER
SCOOTER REAR VIEW MIRRORS

KYMCO





50: Agility R16 08-12 • Super 8 07-09 • 125: Agility R16 08-12 • 150: Agility R16 08-09 • 200: Agility R16 10-12

	CODICE RMS - RMS CODE		COLORE COLOR	LATO SIDE	PASSO THREAD
	12 277 0360				
	 R.O. 00188000 – 88110-LEB5-C10		Nero Black	Destro Right	8 x 1,25 
	12 276 0360				
	 R.O. 00188001 – 88120-LEB5-C10		Nero Black	Sinistro Left	8 x 1,25 





50: Agility 4T Carry, R10, R12 05-11 • 125: Agility 4T, Carry 06-11

	CODICE RMS - RMS CODE		COLORE COLOR	LATO SIDE	PASSO THREAD
	12 277 0910				
	 R.O. 00152115		Nero Black	Destro Right	8 x 1,25 
	12 276 0910				
	 R.O. 00152116		Nero Black	Sinistro Left	8 x 1,25 





50: People S 2t-4t 05-10 • Vitality 2t-4t 04-08 • 125: People S Dd Eu3 07-08 • People S 05 • 200: People Si 07 • People S 06

	CODICE RMS - RMS CODE		COLORE COLOR	LATO SIDE	PASSO THREAD
	12 277 0610				
	 R.O. 00153132 – 88110-LBD5-E000		Nero Black	Destro Right	8 x 1,25 
	12 276 0580				
	 R.O. 00153133 – 88120-LBD5-E000		Nero Black	Sinistro Left	8 x 1,25 

50: People 99-11 • 125: People 97-11

	CODICE RMS - RMS CODE		COLORE COLOR	LATO SIDE	PASSO THREAD
	12 277 0310				
	 R.O. 00152304 – 88110-KFA-600		Cromato Chromed	Destro Right	8 x 1,25 
	12 276 0310				
	 R.O. 00152305 – 88120-KFA-900		Cromato Chromed	Sinistro Left	8 x 1,25 

50: B&w Eu 2 03 • 125: B&w 00-04 • 150: B&w 00-04 • 250: B&w 00-03

	CODICE RMS - RMS CODE		COLORE COLOR	LATO SIDE	PASSO THREAD
	12 277 0820				
	 R.O. 00152910N		Nero Black	Destro Right	10 x 1,25 
	12 276 0820				
	 R.O. 00152913N		Nero Black	Sinistro Left	10 x 1,25 



KYMCO

50-125-200: Like 09-13

	CODICE RMS - RMS CODE		COLORE COLOR	LATO SIDE	PASSO THREAD
	12 277 1150		Cromato Chromed	Destro Right	8 x 1,25
	R.O. 00188024		Cromato Chromed	Sinistro Left	8 x 1,25
	12 276 1150				
			Cromato Chromed	Sinistro Left	8 x 1,25
R.O. 00188023					

125: Downtown 09-14 • K-Xct I 12-14 • **200:** Downtown I 10 • **300:** Downtown 09-11 • K-Xct I 12-14

	CODICE RMS - RMS CODE		COLORE COLOR	LATO SIDE	PASSO THREAD
	12 277 1650		Nero Black	Destro Right	10 x 1,25
	R.O. 00188025		Nero Black	Sinistro Left	10 x 1,25
	12 276 1650				
			Nero Black	Sinistro Left	10 x 1,25
R.O. 00188026					

50: Dink 4T 07 - **125:** Dink Eu3 06-07 - **200:** Dink Eu3 I 06-07

	CODICE RMS - RMS CODE		COLORE COLOR	LATO SIDE	PASSO THREAD
	12 277 1210		Nero Black	Destro Right	10 x 1,25
	R.O. 00152956		Nero Black	Sinistro Left	10 x 1,25
	12 276 1210				
			Nero Black	Sinistro Left	10 x 1,25
R.O. 00152957					

125: People Gti 10-14 • **200:** People Gti 10-14 • **300:** People Gti 10-14

	CODICE RMS - RMS CODE		COLORE COLOR	LATO SIDE	PASSO THREAD
	12 277 1720		Nero Black	Destro Right	10 x 1,25
	R.O. 00188031		Nero Black	Sinistro Left	10 x 1,25
	12 276 1720				
			Nero Black	Sinistro Left	10 x 1,25
R.O. 00188034					







125: People One 13-16

	CODICE RMS - RMS CODE		COLORE COLOR	LATO SIDE	PASSO THREAD
	12 277 1700		Cromato Chromed	Destro Right	10 x 1,25
	R.O. 00188057		Cromato Chromed	Sinistro Left	10 x 1,25
	12 276 1700				
			Cromato Chromed	Sinistro Left	10 x 1,25
R.O. 00188058					

SPECCHI RETROVISORI SCOOTER
SCOOTER REAR VIEW MIRRORS







KEEWAY

50: Hurricane







 	CODICE RMS - RMS CODE		COLORE COLOR	LATO SIDE	PASSO THREAD
	12 277 1590		Nero Black	Destro Right	8 x 1,25 
					
	12 276 1590		Nero Black	Sinistro Left	8 x 1,25 
					

MALAGUTI







50: F10 Jet Line Kat 92-00 • F12 Mod. 94-02 • Centro 93-00 • **50-100:** Ciak 99-01 • Crosser 95-98-Yesterday • Euro 97-00 • **125-150:** F18 Warrior

 	CODICE RMS - RMS CODE		COLORE COLOR	LATO SIDE	PASSO THREAD
	12 277 0040		Nero Black	Destro Right	8 x 1,25 
					
	R.O. 08803524		Nero Black	Sinistro Left	8 x 1,25 
12 276 0040					
		R.O. 08803424			

50: F12 R Phantom Ac 07-10 • F12 R Phantom Lc 07-10 • **125:** Blog 09-11 • **160:** Blog 09-11







 	CODICE RMS - RMS CODE		COLORE COLOR	LATO SIDE	PASSO THREAD
	12 277 1610		Nero Black	Destro Right	8 x 1,25 
					
	R.O. 08805203		Nero Black	Sinistro Left	8 x 1,25 
12 276 1610					
		R.O. 08805303			



50: Centro 4T 08-10 • **125:** Centro 08-11 • **160:** Centro 08-11 • **250:** Password 05-08

 	CODICE RMS - RMS CODE		COLORE COLOR	LATO SIDE	PASSO THREAD
	12 277 0390		Nero Black	Destro Right	10 x 1,25 
					
	R.O. 08804903		Nero Black	Sinistro Left	10 x 1,25 
12 276 0390					
		R.O. 08804803			

MBK

50: Booster Naked 03 • Booster spirit 96-03 • Booster 01-04 • Booster Ng 95-03 • Booster Rocket 97-98 • Booster Track 02 • Stunt 00-02

 	CODICE RMS - RMS CODE		COLORE COLOR	LATO SIDE	PASSO THREAD
	12 277 0030		Nero Black	Destro Right	8 x 1,25 
					
	R.O. 4SBF62800000		Nero Black	Sinistro Left	8 x 1,25 
12 276 0030					
		R.O. 4SBF62900000			

-  Filetto sinistro - *Left Thread*
-  Filetto destro - *Right Thread*







SPECCHI RETROVISORI SCOOTER

SCOOTER REAR VIEW MIRRORS









MBK







50: Booster Spirit 00 • Nitro 99-04

 	CODICE RMS - RMS CODE	COLORE COLOR	LATO SIDE	PASSO THREAD
	12 277 0050			
	 R. O. 5BRF62801000	Nero Black	Destro Right	8 x 1,25 
	12 276 0050			
	 R. O. 5BRF62901000	Nero Black	Sinistro Left	8 x 1,25 
	12 276 0050			







50: Booster Spirit 03 • Booster 01-03 • Booster Ng 95-03 • Booster Rocket 97-98 • Booster Track 96-98

 	CODICE RMS - RMS CODE	COLORE COLOR	LATO SIDE	PASSO THREAD
	12 277 0800			
	 R.O. 4SBF62900000	Nero Black	Destro Right	8 x 1,25 
	12 276 0800			
	 R.O. 4SBF62800000	Nero Black	Sinistro Left	8 X 1,25 
	12 276 0800			

50: Ovetto 97-01 • **100:** Ovetto







 	CODICE RMS - RMS CODE	COLORE COLOR	LATO SIDE	PASSO THREAD
	12 277 0580			
	 R.O. 5ADF62901000	Nero Black	Destro Right	8 x 1,25 
	12 276 0580			
	 R.O. 5ADF62801000	Nero Black	Sinistro Left	8 x 1,25 
	12 276 0580			

250: Skyliner 00-03

 	CODICE RMS - RMS CODE	COLORE COLOR	LATO SIDE	PASSO THREAD
	12 277 0560			
	 R.O. 5CG262901000	Nero Black	Destro Right	10 X 1,25 
	12 276 0560			
	 R.O. 5CG262801000	Nero Black	Sinistro Left	10 X 1,25 
	12 276 0560			

PEUGEOT





50: Speedfight acqua Dt 97-98 • Speedfight aria 97 • Speedfight acqua Dd 97-98 • Speedfight aria-cat. 98-99 • X-Fight 00-> • Trekker Road 98-00 • Vivacity Cat. 99-02 • **100:** Speedfight 97 • Vivacity Cat. 99-02 • X-Fight 00-01 • Speedfight 98-00 • Trekker

 	CODICE RMS - RMS CODE	COLORE COLOR	LATO SIDE	PASSO THREAD
	12 277 0150			
	 R.O. 738998	Nero Black	Destro Right	8 x 1,25 
	12 276 0150			
	 R.O. 738997	Nero Black	Sinistro Left	8 x 1,25 
	12 276 0150			





SPECCHI RETROVISORI SCOOTER
SCOOTER REAR VIEW MIRRORS

PEUGEOT



50: Jet Force • Speedfight 2 Ac 05-08 • Jet C • Tech 07-10 • **125:** Jet Force

 <p>E-MARK</p>	CODICE RMS - RMS CODE		COLORE COLOR	LATO SIDE	PASSO THREAD
	12 277 0400		Nero Black	Destro Right	8 x 1,25 
	 R.O. 748212				
	12 276 0400		Nero Black	Sinistro Left	8 x 1,25 
	 R.O. 748211				





50: Speedfight acqua Dt 97-98 • Speedfight aria 97 • **100:** Speedfight 97 • **50-100:** Vivacity Cat. 99-02 • **100:** X-Fight 00-01

	CODICE RMS - RMS CODE		COLORE COLOR	LATO SIDE	PASSO THREAD
	12 277 0810		Nero Black	Destro Right	8 x 1,25 
	 R.O. 735175				
	12 276 0810		Nero Black	Sinistro Left	8 x 1,25 
	 R.O. 735174				

50: Kisbee u-X • Kisbee • Viva 3 L 2T/4T • **125:** Viva 3 L 4T

 <p>E-MARK</p>	CODICE RMS - RMS CODE		COLORE COLOR	LATO SIDE	PASSO THREAD
	12 277 1570		Nero Black	Destro Right	-
	 R.O. 772582				
	12 276 1570		Nero Black	Sinistro Left	-
	 R.O. 772581				

50 Looxor 2 • Looxor Niu2 • Looxor N • Tkr Eu1 • Tkr2 Eu

 <p>E-MARK</p>	CODICE RMS - RMS CODE		COLORE COLOR	LATO SIDE	PASSO THREAD
	12 277 1670		Nero Black	Destro Right	8 x 1,25 
	 R.O. 746781				
	12 276 1670		Nero Black	Sinistro Left	8 x 1,25 
	 R.O. 746782				



PEUGEOT

125-200: Lxr

	CODICE RMS - RMS CODE	COLORE COLOR	LATO SIDE	PASSO THREAD
	12 277 1590	Nero Black	Destro Right	8 x 1,25
	R.O. 881200	Nero Black	Sinistro Left	8 x 1,25
	12 276 1590			
R.O. 881201				

125: Geopolis C / E / Es / Sc / S - **250:** Geopolis C / Sc / S - **400:** Geopolis C / Sc / S - **500:** Geopolis

	CODICE RMS - RMS CODE	COLORE COLOR	LATO SIDE	PASSO THREAD
	12 277 1630	Nero Black	Destro Right	10 x 1,25
	R.O. 770022	Nero Black	Sinistro Left	10 x 1,25
	12 276 1630			
R.O. 770021				

50: E Vivacity • Ludix 10L Trend • Ludix 10 Or Snake • Ludix 10 RBP2 • Ludix 10 RL Trend • Ludix 12RL2/3 • Ludix 14L Elegance • Ludix 14RL2 • Tkr2 E • Tkr2 R12 • Tkr2 R • Viva 2 Eu • Viva 2 Co • Viva 2 R • Viva 2 SL4 Eu • **125:** Looxor Adv2 • **150:** Looxor Adv2

	CODICE RMS - RMS CODE	COLORE COLOR	LATO SIDE	PASSO THREAD
	12 277 1660	Nero Black	Destro Right	8 x 1,25
	R.O. A05730	Nero Black	Sinistro Left	8 x 1,25
	12 276 1660			
R.O. 761702				







125: Geo C - Es - E - Sc • **250:** Geo C - Sc - S • **300:** Geo St - Ev 2D - Ev • **400:** C - Sc - S • **500:** Geo

	CODICE RMS - RMS CODE	COLORE COLOR	LATO SIDE	PASSO THREAD
	12 277 1560	Nero Black	Destro Right	10 x 1,25
	R.O. 774987	Nero Black	Sinistro Left	10 x 1,25
	12 276 1560			
R.O. 774986				







SPECCHI RETROVISORI SCOOTER
SCOOTER REAR VIEW MIRRORS

PIAGGIO







50: Free FL 95-02 • Free Delivery 00-01 • 100: Free 02-03

 <p>E-MARK</p>	CODICE RMS - RMS CODE		COLORE COLOR	LATO SIDE	PASSO THREAD
	12 277 0950				
	 R.O. 582892		Nero Black	Destro Right	8 x 1,25 
	12 276 0950				
	 R.O. 582891		Nero Black	Sinistro Left	8 x 1,25 
	12 276 0950				
 R.O. 582891		Nero Black	Sinistro Left	8 x 1,25 	







50: Fly 08-11 • 100: Fly 4T 06-08 • 125: Fly 05-11 • 150: Fly 05-07

 <p>E-MARK</p>	CODICE RMS - RMS CODE		COLORE COLOR	LATO SIDE	PASSO THREAD
	12 277 0530				
	 R.O. CM027002-027005		Nero Black	Destro Right	8 x 1,25 
	12 276 0530				
	 R.O. CM027001-027004		Nero Black	Sinistro Left	8 x 1,25 
	12 276 0530				
 R.O. CM027001-027004		Nero Black	Sinistro Left	8 x 1,25 	







50: Nrg 94-98 • Ntt 95-96 • Typhoon 01-04



 <p>E-MARK</p>	CODICE RMS - RMS CODE		COLORE COLOR	LATO SIDE	PASSO THREAD
	12 277 0060				
	 R.O. 271018		Nero Black	Destro Right	8 x 1,25 
	12 276 0060				
	 R.O. 271022		Nero Black	Sinistro Left	8 x 1,25 
	12 276 0060				
 R.O. 271022		Nero Black	Sinistro Left	8 x 1,25 	

50: Nrg Extreme 99-00 • Nrg Mc3 01-04 • Nrg Purejet 02-04 • Nrg Rst Mc2 96-98 • Quartz 92-96 • Zip Fast Rider Rst 96-97 • Zip Fast Rider 93-94 • Zip Rst 96-99 • Zip 95-96 • 80: Skr City 99 • 125: Skipper 94-97

 <p>E-MARK</p>	CODICE RMS - RMS CODE		COLORE COLOR	LATO SIDE	PASSO THREAD
	12 277 0700				
	 R.O. 563496		Nero Black	Destro Right	8 x 1,25 
	12 276 0700				
	 R.O. 563492		Nero Black	Sinistro Left	8 x 1,25 
	12 276 0700				
 R.O. 563492		Nero Black	Sinistro Left	8 x 1,25 	

50: Nrg Power 04-15 • Nrg Purejet 05-10 • Typhoon 05-11

 <p>E-MARK</p>	CODICE RMS - RMS CODE		COLORE COLOR	LATO SIDE	PASSO THREAD
	12 277 0420				
	 R.O. CM073002		Nero Black	Destro Right	Ø8 x 1,25 
	12 276 0420				
	 R.O. CM073001		Nero Black	Sinistro Left	Ø8 x 1,25 
	12 276 0420				
 R.O. CM073001		Nero Black	Sinistro Left	Ø8 x 1,25 	

-  Filetto sinistro - *Left Thread*
-  Filetto destro - *Right Thread*





SPECCHI RETROVISORI SCOOTER

SCOOTER REAR VIEW MIRRORS







PIAGGIO





50: Zip 4T 00-13 • Zip Sp 01-13 • Zip 00-04 • **100:** Zip 4T 06-10 • **125:** Zip 00-02

	E-MARK	CODICE RMS - RMS CODE	COLORE COLOR	LATO SIDE	PASSO THREAD
	12 277 0520	Nero <i>Black</i>			
			R.O. CM063902		
	12 276 0520	Nero <i>Black</i>		Sinistro <i>Left</i>	8 x 1,25 
			R.O. CM063901		





50: Liberty 97-05 • Liberty 4T 00-02 • **125:** Liberty 01-02

	E-MARK	CODICE RMS - RMS CODE	COLORE COLOR	LATO SIDE	PASSO THREAD
	12 277 0070	Nero <i>Black</i>			
			R.O. 583033		
	12 276 0070	Nero <i>Black</i>		Sinistro <i>Left</i>	8x1,25 
			R.O. 583031		





50: Liberty 4T Delivery - Ptt - Tnt 09-15 • Liberty Moc 2T & Elle 09-13 • **125:** Liberty 4T 07-15 • Liberty Rst 04-11 • **150:** Liberty 4T 08-14
• **200:** Liberty 4T - Rst 04-08

	E-MARK	CODICE RMS - RMS CODE	COLORE COLOR	LATO SIDE	PASSO THREAD
	12 277 0670	Cromato <i>Chromed</i>			
			R.O. 57325R - CM020402		
	12 276 0670	Cromato <i>Chromed</i>		Sinistro <i>Left</i>	8 x 1,25 
			R.O. 57325R - CM020401		

50: Liberty 2T Sport 06 • Liberty 4T Sport 06 • **125:** Liberty Sport 06-08 • **200:** Liberty Sport 06-07

	E-MARK	CODICE RMS - RMS CODE	COLORE COLOR	LATO SIDE	PASSO THREAD
	12 277 0830	Nero <i>Black</i>			
			R.O. CM020408		
	12 276 0830	Nero <i>Black</i>		Sinistro <i>Left</i>	8 x 1,25 
			R.O. CM020407		



50: Liberty 4T Delivery 10-14 • **125:** Liberty 4T Delivery 07-15

	E-MARK	CODICE RMS - RMS CODE	COLORE COLOR	LATO SIDE	PASSO THREAD
	12 277 0840	Nero <i>Black</i>			
			R.O. 599361		
	12 276 0840	Nero <i>Black</i>		Sinistro <i>Left</i>	8 x 1,25 
			R.O. 622830		





SPECCHI RETROVISORI SCOOTER
SCOOTER REAR VIEW MIRRORS

PIAGGIO





50: Vespa S 2T 07-12 • Vespa S 4T-4V 08-12 • **125:** Vespa S 4T 07-12 • **150:** Vespa S 4T 08-12

	CODICE RMS - RMS CODE		COLORE COLOR	LATO SIDE	PASSO THREAD
	12 277 0270		Cromato Chromed	Destro Right	Cilindrico Ø 10
	 R.O. CM178902				
	12 276 0270		Cromato Chromed	Sinistro Left	Cilindrico Ø 10
	 R.O. CM178901				



50: Vespa Lx 2t 05-13 • Vespa Lx 4T 05-13 • **125:** Vespa Lx 05-13 • **150:** Vespa Lx 05-13

	CODICE RMS - RMS CODE		COLORE COLOR	LATO SIDE	PASSO THREAD
	12 277 0590		Cromato Chromed	Destro Right	8 x 1,25 
	 R.O. CM020405				
	12 276 0590		Cromato Chromed	Sinistro Left	8 x 1,25 
	 R.O. CM020404				





50: Vespa Lxv 2T 06-09 • **125:** Vespa Gtv 06-08 • Vespa Lxv 4T 06-13 • **250:** Vespa Gtv 07-09 • Vespa Gt 60 06-07 • **300:** Vespa Gtv 10-13

	CODICE RMS - RMS CODE		COLORE COLOR	LATO SIDE	PASSO THREAD
	12 277 0680		Cromato Chromed	Destro Right	8 x 1,25 
	 R.O. CM073414				
	12 276 0680		Cromato Chromed	Sinistro Left	8 x 1,25 
	 R.O. CM073413				

50: Vespa Lx 2T 09-13 • Vespa Lx 4T-4V 09-13 • **125:** Vespa Gts 09-16 • Vespa Lx 09-12

	CODICE RMS - RMS CODE		COLORE COLOR	LATO SIDE	PASSO THREAD
	12 277 0660		Cromato Chromed	Destro Right	Cilindrico Ø 10
	 R.O. CM179802				
	12 276 0660		Cromato Chromed	Sinistro Left	Cilindrico Ø 10
	 R.O. CM179801				

50: Vespa Et2 97-05 • **125:** Vespa Et4 96-98

	CODICE RMS - RMS CODE		COLORE COLOR	LATO SIDE	PASSO THREAD
	12 277 0490		Nero grigio Black Gray	Destro Right	8 x 1,25 
	 R.O. 563865-560583				
	12 276 0490		Nero grigio Black Gray	Sinistro Left	8 x 1,25 
	 R.O. 563866-273852				

- Filetto sinistro - Left Thread
- Filetto destro - Right Thread





SPECCHI RETROVISORI SCOOTER

SCOOTER REAR VIEW MIRRORS







PIAGGIO





50: Vespa Et2 97-05 • Vespa Et4 00-05 • **125:** Vespa Et4 99-02

	CODICE RMS - RMS CODE	COLORE COLOR	LATO SIDE	PASSO THREAD
	12 277 0510	Nero Black	Destro Right	8 x 1,25 
	 R.O. 581555			
	12 276 0510	Nero Black	Sinistro Left	8 x 1,25 
	 R.O. 581554			





50: Vespa Lxv 2t 06-09 • **125:** Vespa Gtv 06-08 • Vespa Gts 07-16 • Vespa Lxv 06-13 • **250:** Vespa Gt 60 06-07 • Vespa Gtv 07-09 • Vespa Gts 05-16
300: Vespa Gtv 06-13 • Vespa Gts 10-15

	CODICE RMS - RMS CODE	COLORE COLOR	LATO SIDE	PASSO THREAD
	12 277 0460	Cromato Chromed	Destro Right	8 x 1,25 
	 R.O. CM073411-073414 - CM073408			
	12 276 0460	Cromato Chromed	Sinistro Left	8 x 1,25 
	 R.O. CM073410-073413 - CM073407 CM073407			





50: Liberty Elettrico Ppt 11 • Liberty Moc & Elle 09-16 • Liberty 4T Ptt 07-15 • Liberty 4T Delivery 10-14 • **125:** Liberty 4T 07-15

	CODICE RMS - RMS CODE	COLORE COLOR	LATO SIDE	PASSO THREAD
	12 277 1160	Cromato Chromed	Destro Right	8 x 1,25 
	 R.O. CM020402			
	12 276 1160	Cromato Chromed	Sinistro Left	8 x 1,25 
	 R.O. CM020401			

50: Vespa Lx 4T 4V 09-13 • Vespa Lx 2T 09-13 • **125:** Vespa Lx 4T 09-13 • **150:** Vespa Lx 4T 12-13

	CODICE RMS - RMS CODE	COLORE COLOR	LATO SIDE	PASSO THREAD
	12 277 1170	Cromato Chromed	Destro Right	8 x 1,25 
	 R.O. CM020405			
	12 276 1170	Cromato Chromed	Sinistro Left	8 x 1,25 
	 R.O. CM020412			





50: Vespa Primavera 2T-4T 13-16 • **125:** Vespa Primavera 4T 3V Iget 16 • Vespa Lx Primavera 4T 3V 13-16 • **150:** Vespa Primavera 4T 3V 13-16
 • Vespa Primavera 4T 3V Iget 16

	CODICE RMS - RMS CODE	COLORE COLOR	LATO SIDE	PASSO THREAD
	12 277 1200	Cromato Chromed	Destro Right	8 x 1,25 
	 R.O. CM182102-CM261902			
	12 276 1200	Cromato Chromed	Sinistro Left	8 x 1,25 
	 R.O. CM182101-CM261901			





SPECCHI RETROVISORI SCOOTER
SCOOTER REAR VIEW MIRRORS

PIAGGIO





50-125-150: Liberty Iget 4T 3V Ie 15

	CODICE RMS - RMS CODE		COLORE COLOR	LATO SIDE	PASSO THREAD
	12 277 2530		Cromato Chromed	Destro Right	8x1,25 
	 R.O. CM020418				
	12 276 2530		Cromato Chromed	Sinistro Left	8x1,25 
	 R.O. CM020417				



50: Vespa Sprint 4T 4V 14 • **125:** Vespa Sprint 4T 3V Ie 14-15 • **150:** Vespa Sprint 4T 3V Ie 15

	CODICE RMS - RMS CODE		COLORE COLOR	LATO SIDE	PASSO THREAD
	12 277 2540		Cromato Chromed	Destro Right	8x1,25 
	 R.O. CM262001				
	12 276 2540		Cromato Chromed	Sinistro Left	8x1,25 
	 R.O. CM262002				





125: Vespa Lxv Ie 4T 10-13 • **300:** Vespa Gtv 4T 4V Ie 10-13



	CODICE RMS - RMS CODE		COLORE COLOR	LATO SIDE	PASSO THREAD
	12 277 2050		Cromato Chromed	Destro Right	8 x 1,25 
	 R.O. CM073419				
	12 276 2050		Cromato Chromed	Sinistro Left	8 x 1,25 
	 R.O. CM073418				

125-250: X Evo 07-16 • **400:** X Evo 07-11

	CODICE RMS - RMS CODE		COLORE COLOR	LATO SIDE	PASSO THREAD
	12 277 0960		Nero Black	Destro Right	Fori passanti Passing Holes
	 R.O. CM180301				
	12 276 0960		Nero Black	Sinistro Left	Fori passanti Passing Holes
	 R.O. CM180302				

125: Mp3 Yourban ERL 11-13 • **300:** Mp3 Yourban ERL 11-15 • Mp3 Lt 11-14 • **500:** Mp3 Sport RL 14-15 • Mp3 Sport Lt 11-12 • Mp3 Lt 11-13

	CODICE RMS - RMS CODE		COLORE COLOR	LATO SIDE	PASSO THREAD
	12 277 0970		Nero Black	Destro Right	8 x 1,25 
	 R.O. CM175020				
	12 276 0970		Nero Black	Sinistro Left	8 x 1,25 
	 R.O. CM175019				

-  Filetto sinistro - *Left Thread*
-  Filetto destro - *Right Thread*





SPECCHI RETROVISORI SCOOTER

SCOOTER REAR VIEW MIRRORS







PIAGGIO





125: Beverly Rst 04-07 • Beverly Eu3 07-08 • **250:** Beverly Rst 04-05 • Beverly ie Eu3 06-08 • Beverly 06-07

	E-MARK	CODICE RMS - RMS CODE	COLORE COLOR	LATO SIDE	PASSO THREAD
		12 277 0450	Cromato <i>Chromed</i>	Destro <i>Right</i>	10 X 1,25 
					
		R.O. CM025502			
		12 276 0450	Cromato <i>Chromed</i>	Sinistro <i>Left</i>	10 X 1,25 
					
	R.O. CM025501				

125: Beverly Rst 4T 4V ie Eu3 10-15 • **300:** Beverly Rst 4T 4V ie Eu3 10-15 • Beverly ie E4 16



	E-MARK	CODICE RMS - RMS CODE	COLORE COLOR	LATO SIDE	PASSO THREAD
		12 277 0770	Cromato <i>Chromed</i>	Destro <i>Right</i>	10x1,25 
					
		R.O. CM179905			
		12 276 0770	Cromato <i>Chromed</i>	Sinistro <i>Left</i>	10x1,25 
					
	R.O. CM179904				

125: X7 Eu 3 08 • X7 Evo ie Eu 3 09-10 • **250:** X7 Eu 3 08 • **300:** X7 Evo ie Eu 3 09-10



	E-MARK	CODICE RMS - RMS CODE	COLORE COLOR	LATO SIDE	PASSO THREAD
		12 277 0760	Nero <i>Black</i>	Destro <i>Right</i>	10x1,25 
					
		R.O. CM175012			
		12 276 0760	Nero <i>Black</i>	Sinistro <i>Left</i>	10x1,25 
					
	R.O. CM175011				

125: X8 04-08 • X8 Eu 2 • Premium-Street 06-08 • **150:** X8 Eu 2 • Premium-Street 06-08 • **200-250:** X8 04-08 • **400:** X8 06-08

Applicabile anche a: - *Applicable also to:* **125:** X Evo 07-12 • **250:** X Evo 07-11 • **400:** X Evo 07-11

	E-MARK	CODICE RMS - RMS CODE	COLORE COLOR	LATO SIDE	PASSO THREAD
		12 277 0470	Nero Opaco <i>Matt Black</i>	Destro <i>Right</i>	Fori passanti <i>Passing Holes</i>
					
		R.O. CM073901-174801			
		12 276 0470	Nero Opaco <i>Matt Black</i>	Sinistro <i>Left</i>	Fori passanti <i>Passing Holes</i>
					
	R.O. CM073902-174802				





125: X9 01-02 • **180:** X9 180 Amalfi 00-03 • **200:** X9 02-03 • **250:** X9 Motore Honda 00-03

	E-MARK	CODICE RMS - RMS CODE	COLORE COLOR	LATO SIDE	PASSO THREAD
		12 277 0480	Nero <i>Black</i>	Destro <i>Right</i>	Fori passanti <i>Passing Holes</i>
					
		R.O. 581500			
		12 276 0480	Nero <i>Black</i>	Sinistro <i>Left</i>	Fori passanti <i>Passing Holes</i>
					
	R.O. 581501				





SPECCHI RETROVISORI SCOOTER
SCOOTER REAR VIEW MIRRORS

PIAGGIO





125-200-250: Carnaby 07-10

 <p>E-MARK</p>	CODICE RMS - RMS CODE		COLORE COLOR	LATO SIDE	PASSO THREAD
	12 277 0410		Nero Black	Destro Right	10x1,25 
	 R.O. CM174706				
	12 276 0410		Nero Black	Sinistro Left	10x1,25 
	 R.O. CM174705				



125: Mp3 06-08 • Mp3 Ibrido 09-10 • Mp3 Lt Touring 11-12 • **250-300:** Mp3 Lt 06-14 • **400:** Mp3 RL • Lt 07-11 • **500:** Mp3 RL • Lt 11-16

 <p>E-MARK</p>	CODICE RMS - RMS CODE		COLORE COLOR	LATO SIDE	PASSO THREAD
	12 277 0430		Nero Black	Destro Right	8 x 1,25 
	 R.O. CM174709				
	12 276 0430		Nero Black	Sinistro Left	8 x 1,25 
	 R.O. CM174708				





125: Vespa Granturismo Eu 3 06-07 • Granturismo 03-07 • **200:** Granturismo 06-07



 <p>E-MARK</p>	CODICE RMS - RMS CODE		COLORE COLOR	LATO SIDE	PASSO THREAD
	12 277 0690		Cromato Chromed	Destro Right	8x1,25 
	 R.O. CM073402 - CM027705				
	12 276 0690		Cromato Chromed	Sinistro Left	8x1,25 
	 R.O. CM073401 - CM027704				

125: Vespa Px 30 anni 07-08 • Vespa Px 11-16 • Vespa Px 98-01 • **150:** Vespa Px 11-16

 <p>E-MARK</p>	CODICE RMS - RMS CODE		COLORE COLOR	LATO SIDE	PASSO THREAD
	12 277 0790		Cromato Chromed	Destro Right	Cilindrico Ø 10
	 R.O. CM181302				
	12 276 0790		Cromato Chromed	Sinistro Left	Cilindrico Ø 10
	 R.O. CM181301				

125: X10 4T 4V ie 12-13 • **350:** X10 4T 4V ie 12-15 • **500:** X10 4T 4V ie 12-14

 <p>E-MARK</p>	CODICE RMS - RMS CODE		COLORE COLOR	LATO SIDE	PASSO THREAD
	12 277 1120		Nero Black	Destro Right	8x1,25 
	 R.O. CM182006				
	12 276 1120		Nero Black	Sinistro Left	8x1,25 
	 R.O. CM182005				

-  Filetto sinistro - *Left Thread*
-  Filetto destro - *Right Thread*



SPECCHI RETROVISORI SCOOTER

SCOOTER REAR VIEW MIRRORS







PIAGGIO





250: Beverly Cruiser 07-09 • **500:** Beverly Cruiser 07-12

 E-MARK	CODICE RMS - <i>RMS CODE</i>	COLORE COLOR	LATO SIDE	PASSO THREAD
	12 277 0740	Cromato <i>Chromed</i>	Destro <i>Right</i>	Cilindrico Ø 10
	 R.O. CM178801			
	12 276 0740	Cromato <i>Chromed</i>	Sinistro <i>Left</i>	Cilindrico Ø 10
	 R.O. CM178802			





125: Beverly Tourer Eu3 07-10 • **250:** Beverly Tourer Eu3 07-09 • **300:** Beverly Tourer Eu3 09-10 • **400:** Beverly Tourer Eu3 08-10
500: Beverly 02-06 • Beverly Eu3 06-08

 E-MARK	CODICE RMS - <i>RMS CODE</i>	COLORE COLOR	LATO SIDE	PASSO THREAD
	12 277 0440	Cromato <i>Chromed</i>	Destro <i>Right</i>	10 X 1,25 
	 R.O. CM071905-CM071902			
	12 276 0440	Cromato <i>Chromed</i>	Sinistro <i>Left</i>	10 X 1,25 
	 R.O. CM071904-CM071901			





300: Carnaby Cruiser 09-12

 E-MARK	CODICE RMS - <i>RMS CODE</i>	COLORE COLOR	LATO SIDE	PASSO THREAD
	12 277 0780	Cromato <i>Chromed</i>	Destro <i>Right</i>	10x1,25 
	 R.O. CM179902			
	12 276 0780	Cromato <i>Chromed</i>	Sinistro <i>Left</i>	10x1,25 
	 R.O. CM179901			

400: Beverly Eu 3 06-07

 E-MARK	CODICE RMS - <i>RMS CODE</i>	COLORE COLOR	LATO SIDE	PASSO THREAD
	12 277 0340	Cromato <i>Chromed</i>	Destro <i>Right</i>	10x1,25 
	 R.O. CM071908			
	12 276 0340	Cromato <i>Chromed</i>	Sinistro <i>Left</i>	10x1,25 
	 R.O. CM071907			



250: Beverly Cruiser 07-09 • **500:** Beverly Cruiser 07-12

 E-MARK	CODICE RMS - <i>RMS CODE</i>	COLORE COLOR	LATO SIDE	PASSO THREAD
	12 277 0930	Cromato <i>Chromed</i>	Destro <i>Right</i>	10x1,25 
	 R.O. CM071914			
	12 276 0930	Cromato <i>Chromed</i>	Sinistro <i>Left</i>	10x1,25 
	 R.O. CM071913			



SPECCHI RETROVISORI SCOOTER
SCOOTER REAR VIEW MIRRORS

PIAGGIO



Vespa: Attacco con piastra - *Mounting plate* • Predisposto per Vespa - *For Vespa*

	CODICE RMS - RMS CODE			
	12 276 0110			
				



Specchio Vintage per Vespa Ø 105 - *Vintage rear view mirror for Vespa Ø 105*

	CODICE RMS - RMS CODE		COLORE COLOR	LATO SIDE	PASSO THREAD
	12 277 0920				
			Cromato Chromed	Destro Right	Attacco con Piastra Mounting Plate
	12 276 0920		Cromato Chromed	Sinistro Left	Attacco con Piastra Mounting Plate
					



Specchio Vintage regolabile rettangolare per Vespa - *Adjustable rectangular rear view mirror for Vespa*

	CODICE RMS - RMS CODE		COLORE COLOR	LATO SIDE	PASSO THREAD
	12 277 1780				
			Cromato Chromed	Destro Right Sinistro Left	8 X 1,25 

Specchio Vintage regolabile trapezoidale per Vespa - *Adjustable trapezoidal rear view mirror for Vespa*

	CODICE RMS - RMS CODE		COLORE COLOR	LATO SIDE	PASSO THREAD
	12 277 1790				
			Cromato Chromed	Destro Right Sinistro Left	8 X 1,25 

Specchio Vintage regolabile per Vespa Ø 105 - *Adjustable Vintage rear view mirror for Vespa Ø 105*

	CODICE RMS - RMS CODE		COLORE COLOR	LATO SIDE	PASSO THREAD
	12 277 1580				
			Cromato Chromed	Destro Right Sinistro Left	8 x 1,25 



PIAGGIO

50: Ape FL3 Europa 96-99 • Rst Mix 99-03

	CODICE RMS - RMS CODE		COLORE COLOR	LATO SIDE	PASSO THREAD
	12 277 0710				
			Nero Black	Destro Right	8 x 1,25
	R.O. 565062				
	12 276 0710		Nero Black	Sinistro Left	8 x 1,25
R.O. 565061					

Ape

	CODICE RMS - RMS CODE	
	12 276 0010	
<ul style="list-style-type: none"> • Vetro convesso - <i>Convex glass</i> • Asta semplice Ø 8 mm. - <i>Shaft Ø 8 mm</i> • Attacco come l'originale - <i>Attack same as original</i> • Applicazione Ape tutti i modelli - <i>All Ape models</i> 		

SYM

50: Symphony S 10-14 • Symphony 09 • 125: Symphony 09 • Symphony S 09-14 • 150: Symphony S 10-14

	CODICE RMS - RMS CODE		COLORE COLOR	LATO SIDE	PASSO THREAD
	12 277 1040				
			Nero Black	Destro Right	8 x 1,25
	R.O. 88110APA000				
	12 276 1040		Nero Black	Sinistro Left	8 x 1,25
R.O. 88120APA000					

50: Jet 4 09-10 • Jet 4 R 11-14 • Symphony Sr 10-14 • 125: Jet 4 09-10 • Symphony Sr 10-14 • 150: Symphony Sr 10-14

	CODICE RMS - RMS CODE		COLORE COLOR	LATO SIDE	PASSO THREAD
	12 277 1110				
			Nero Black	Destro Right	8 x 1,25
	R.O. 88110ANA000				
	12 276 1110		Nero Black	Sinistro Left	8 x 1,25
R.O. 88120ANA000					





50: Super Fancy 98-00 • Cinderella 99-02 • 100: Cinderella 99-01 • 125: Attila 99-00 • Super Duke 00-01 • Super Fancy 99-02 • 150: Attila 00-01

	CODICE RMS - RMS CODE		COLORE COLOR	LATO SIDE	PASSO THREAD
	12 277 0540				
			Nero Black	Destro Right	8 x 1,25
	R.O. 88110T40000				
	12 276 0540		Nero Black	Sinistro Left	8 x 1,25
R.O. 88120T40000					





SPECCHI RETROVISORI SCOOTER
SCOOTER REAR VIEW MIRRORS

SYM





125: Joyride Evo 09-14 • **200:** Joyride Evo 09-14

 <p>E-MARK</p>	CODICE RMS - RMS CODE		COLORE COLOR	LATO SIDE	PASSO THREAD
	12 277 1180		Nero Black	Destro Right	10 x 1,25 
	 R.O. 88110LVA000				
	12 276 1180		Nero Black	Sinistro Left	10 x 1,25 
	 R.O. 88120LVA000				





125: Hd2 11-14 • **200:** Hd2 I 11-14

 <p>E-MARK</p>	CODICE RMS - RMS CODE		COLORE COLOR	LATO SIDE	PASSO THREAD
	12 277 1710		Nero Black	Destro Right	8 x 1,25 
	 R.O. 88110LDA000				
	12 276 1710		Nero Black	Sinistro Left	8 x 1,25 
	 R.O. 88120LDA000				





125: Joyride 01-02 • Joyride Eu2 03-04 • **150:** Joyride 01-02

 <p>E-MARK</p>	CODICE RMS - RMS CODE		COLORE COLOR	LATO SIDE	PASSO THREAD
	12 277 1730		Nero Black	Destro Right	10 x 1,25 
	 R.O. 88110H9D000				
	12 276 1730		Nero Black	Sinistro Left	10 x 1,25 
	 R.O. 88120H9D000				

125: Joyride 05-07 • **200:** Joyride 05-09

 <p>E-MARK</p>	CODICE RMS - RMS CODE		COLORE COLOR	LATO SIDE	PASSO THREAD
	12 277 1740		Nero/Cromato Black/Chomed	Destro Right	10 x 1,25 
	 R.O. 88110H9A00				
	12 276 1740		Nero/Cromato Black/Chomed	Sinistro Left	10 x 1,25 
	 R.O. 88120H9A00				





125: Hd 07-08 • Hd Evo 05-11 • **200:** Hd 07 • Hd Evo 07-12

 <p>E-MARK NEW</p>	CODICE RMS - RMS CODE		COLORE COLOR	LATO SIDE	PASSO THREAD
	12 277 2550		Nero Black	Destro Right	8 x 1,25 
	 R.O. 88110HHA000				
	12 276 2550		Nero Black	Sinistro Left	8 x 1,25 
	 R.O. 88120HHA000				







SYM

200: Joyride 03 • Joyride Eu2 03-04



	CODICE RMS - RMS CODE		COLORE COLOR	LATO SIDE	PASSO THREAD
	12 277 1770		Nero / Grigio Black / Gray	Destro Right	10 x 1,25 
	 R.O. 88110H9A910				
	12 276 1770		Nero / Grigio Black / Gray	Sinistro Left	10 x 1,25 
	 R.O. 88120H9A910				

SUZUKI





250: An Burgman W-K2 98-02 • 400: An Burgman X-K2 99-02

	CODICE RMS - RMS CODE		COLORE COLOR	LATO SIDE	PASSO THREAD
	12 277 0890		Cromato Chromed	Destro Right	10 x 1,25 
	 R.O. 56500-03F00-000				
	12 276 0890		Cromato Chromed	Sinistro Left	10 x 1,25 
	 R.O. 56600-0F00-000				





Specchio braccio corto adattabile Suzuki Burgman 400 - *Short arm mirror suitable for Suzuki Burgman 400*

	CODICE RMS - RMS CODE		COLORE COLOR	LATO SIDE	PASSO THREAD
	12 276 0990		Cromato Chromed	Destro Right Sinistro Left	10 X 1,25 
					

125-150: Sixteen 08-11

	CODICE RMS - RMS CODE		COLORE COLOR	LATO SIDE	PASSO THREAD
	12 277 1020		Nero Black	Destro Right	10 x 1,25 
	 R.O. 56500-39CF0-000				
	12 276 1020		Nero Black	Sinistro Left	10 x 1,25 
	 R.O. 56600-39CF0-000				





125-200: Uh Burgman 07-13

	CODICE RMS - RMS CODE		COLORE COLOR	LATO SIDE	PASSO THREAD
	12 277 1680		Nero Black	Destro Right	10 x 1,25 
	 R.O. 56500-49F10-000				
	12 276 1680		Nero Black	Sinistro Left	10 x 1,25 
	 R.O. 56600-49F10-000				

SPECCHI RETROVISORI SCOOTER
SCOOTER REAR VIEW MIRRORS





SUZUKI

125: Uh Burgman 14 • 200: Uh Burgman 14





 <p>E-MARK NEW</p>	CODICE RMS - RMS CODE		COLORE COLOR	LATO SIDE	PASSO THREAD
	12 277 2580				
	 R.O. 56500-12J00-000		Nero Black	Destro Right	10x1,25 
	12 276 2580				
	 R.O. 56600-12J00-000		Nero Black	Sinistro Left	10x1,25 

YAMAHA





50: Yq Aerox 09-12 • Ns Aerox 13-16 • Bw's 04-12 • Bw's Bump 13-16 • Bw's Easy 97-98 • Bw's Ng 97-06

 <p>E-MARK</p>	CODICE RMS - RMS CODE		COLORE COLOR	LATO SIDE	PASSO THREAD
	12 277 0800				
	 R.O. 4SBF62900000		Nero Black	Destro Right	8 x 1,25 
	12 276 0800				
	 R.O. 4SBF62800000		Nero Black	Sinistro Left	8 x 1,25 





50: Yq Aerox 99-08 • Bw's Original 99-02 • 100: Yq Aerox R 12



 <p>E-MARK</p>	CODICE RMS - RMS CODE		COLORE COLOR	LATO SIDE	PASSO THREAD
	12 277 0050				
	 R.O. 5BRF62901000		Nero Black	Destro Right	8 x 1,25 
	12 276 0050				
	 R.O. 5BRF62801000		Nero Black	Sinistro Left	8 x 1,25 

50: Bw's Bump 97-98 • Bw's Easy 13 • Bw's Next Generation 97-06 • Bw's R 01 • Bw's 04-16 • Cw L Bw's 03 • Cw Rs Spy 95-98 • Cw Sp Bw's Original Eu2 02 • Ns Aerox 13-16 • Ns F Aerox F 14-16 • Ns N Aerox Naked 13-16 • Yq Aerox 09-12

 <p>E-MARK</p>	CODICE RMS - RMS CODE		COLORE COLOR	LATO SIDE	PASSO THREAD
	12 277 0030				
	 R.O. 4SBF62900000		Nero Black	Destro Right	8 x 1,25 
	12 276 0030				
	 R.O. 4SBF62800000		Nero Black	Sinistro Left	8 x 1,25 

50: Neo's 07-12 • Neo's 4 09-15

 <p>E-MARK</p>	CODICE RMS - RMS CODE		COLORE COLOR	LATO SIDE	PASSO THREAD
	12 277 0880				
	 R.O. 5C2F62900000		Nero Black	Destro Right	8 x 1,25 
	12 276 0880				
	 R.O. 5C2F62800000		Nero Black	Sinistro Left	8 x 1,25 

-  Filetto sinistro - *Left Thread*
-  Filetto destro - *Right Thread*





SPECCHI RETROVISORI SCOOTER

SCOOTER REAR VIEW MIRRORS







YAMAHA





50: Neo's 97-01 • **100:** Neo's 99-02

	E-MARK	CODICE RMS - RMS CODE	COLORE COLOR	LATO SIDE	PASSO THREAD
	12 277 0580	Nero <i>Black</i>			
			R.O. 5ADF62901000		
	12 276 0580	Nero <i>Black</i>		Sinistro <i>Left</i>	8 x 1,25
			R.O. 5ADF62801000		
					





125: Xc Cygnus / R 95-99

	E-MARK	CODICE RMS - RMS CODE	COLORE COLOR	LATO SIDE	PASSO THREAD
	12 277 0850	Nero <i>Black</i>			
			R.O. 4NB262900000		
	12 276 0850	Nero <i>Black</i>		Sinistro <i>Left</i>	10 x 1,25
			R.O. 4NB262800000		
					





125: Yp R X-Max 06-07 • **250:** Yp R X-Max 05-06

	E-MARK	CODICE RMS - RMS CODE	COLORE COLOR	LATO SIDE	PASSO THREAD
	12 277 0860	Nero <i>Black</i>			
			R.O. 1B9F62901000		
	12 276 0860	Nero <i>Black</i>		Sinistro <i>Left</i>	8 X 1,25
			R.O. 1B962801000		
					

125-250: X-Max - X-Max Black 07-09

	E-MARK	CODICE RMS - RMS CODE	COLORE COLOR	LATO SIDE	PASSO THREAD
	12 277 0210	Nero <i>Black</i>			
			R.O. 1B9F629020		
	12 276 0210	Nero <i>Black</i>		Sinistro <i>Left</i>	8 x 1,25
			R.O. 1B9F628020		
					





125: Vp X-City 08-11 • **250:** Vp X-City 07-15

	E-MARK	CODICE RMS - RMS CODE	COLORE COLOR	LATO SIDE	PASSO THREAD
	12 277 1620	Nero <i>Black</i>			
			R.O. 5B2F62900100		
	12 276 1620	Nero <i>Black</i>		Sinistro <i>Left</i>	8 x 1,25
			R.O. 5B2F62800100		
					





SPECCHI RETROVISORI SCOOTER
SCOOTER REAR VIEW MIRRORS

YAMAHA





125-150: Xenter 12-16

 <p>E-MARK</p>	CODICE RMS - RMS CODE		COLORE COLOR	LATO SIDE	PASSO THREAD
	12 277 1080		Nero Black	Destro Right	8 x 1,25 
	 R.O. 52SF62900000				
	12 276 1080		Nero Black	Sinistro Left	8 x 1,25 
	 R.O. 52SF62800000				





250: Majesty 96-98

 <p>E-MARK</p>	CODICE RMS - RMS CODE		COLORE COLOR	LATO SIDE	PASSO THREAD
	12 277 0600		Nero Black	Destro Right	10 x 1,25 
	 R.O. 3TB262901000				
	12 276 0600		Nero Black	Sinistro Left	10 x 1,25 
	 R.O. 3TB262801000				



250: Yp Majesty 98-03 • **400:** Yp Majesty 04-11

 <p>E-MARK</p>	CODICE RMS - RMS CODE		COLORE COLOR	LATO SIDE	PASSO THREAD
	12 277 0560		Nero Black	Destro Right	10 x 1,25 
	 R.O. 5CG262901000				
	12 276 0560		Nero Black	Sinistro Left	10 x 1,25 
	 R.O. 5CG262801000				

300: Xc Versity 03-06

 <p>E-MARK</p>	CODICE RMS - RMS CODE		COLORE COLOR	LATO SIDE	PASSO THREAD
	12 277 1640		Nero Black	Destro Right	8 x 1,25 
	 R.O. 5SEF62900000				
	12 276 1640		Nero Black	Sinistro Left	8 x 1,25 
	 R.O. 5SEF62800000				



500: Xp T • Max 01-06

 <p>E-MARK</p>	CODICE RMS - RMS CODE		COLORE COLOR	LATO SIDE	PASSO THREAD
	12 277 0550		Nero Black	Destro Right	2 Fori 6 mm 2 Holes 6 mm
	 R.O. 5GJ262901000				
	12 276 0550		Nero Black	Sinistro Left	2 Fori 6 mm 2 Holes 6 mm
	 R.O. 5GJ262801000				





YAMAHA





500: Yp T-Max (Abs) 08-11

	CODICE RMS - RMS CODE		COLORE COLOR	LATO SIDE	PASSO THREAD
	12 277 0900		Nero Black	Destro Right	2 Fori 6 mm 2 Holes 6 mm
	 R.O. 4B5262901900				
	12 276 0900		Nero Black	Sinistro Left	2 Fori 6 mm 2 Holes 6 mm
	 R.O. 4B5262801900				

530: T Max 12-14



	CODICE RMS - RMS CODE		COLORE COLOR	LATO SIDE	PASSO THREAD
	12 277 1090		Nero Black	Destro Right	2 Fori passanti Ø 6 2 Passing holes Ø 6
	 R.O. 59C262900000				
	12 276 1090		Nero Black	Sinistro Left	2 Fori passanti Ø 6 2 Passing holes Ø 6
	 R.O. 59C262800000				

125: Yp R X-Max 10-16 • **250:** Yp R X-Max 10-16 • **400:** Yp R X-Max 14-16



	CODICE RMS - RMS CODE		COLORE COLOR	LATO SIDE	PASSO THREAD
	12 277 1760		Nero Black	Destro Right	10 x 1,25 
	 R.O. 37PF62900100				
	12 276 1760		Nero Black	Sinistro Left	10 x 1,25 
	 R.O. 37PF62800100				

UNIVERSALE - UNIVERSAL

Specchio universale per ciclomotore - Universal mirror for moped

	CODICE RMS - RMS CODE		COLORE - COLOR	
	12 276 0100		Nero Black	
	 • Vetro Ø 105 mm. - Glass Ø 105 mm. • Asta semplice Ø 8 mm. - Shaft Ø 8 mm. • Attacco a fascetta al manubrio - Clamp mount			



Specchio tondo universale pieghevole - Universal rounded folding mirror

	CODICE RMS - RMS CODE		COLORE COLOR	LATO SIDE	PASSO THREAD
	12 277 1000		Nero Black	Destro Right Sinistro Left	8 mm
					



SPECCHI RETROVISORI SCOOTER
SCOOTER REAR VIEW MIRRORS

UNIVERSALE - UNIVERSAL



Specchio universale "end bar" alluminio nero - *Universal "end bar" rear view mirror*

	CODICE RMS - RMS CODE	COLORE COLOR	LATO SIDE	PASSO THREAD
	12 277 1510	Nero Black	Destro Right Sinistro Left	Ø 22
				



Specchio universale cromato - *Universal chromed rear view mirror*

	CODICE RMS - RMS CODE	COLORE COLOR	LATO SIDE	PASSO THREAD
	12 277 2190	Cromato Chromed	Destro Right Sinistro Left	
				



Coppia specchi universali con adattatori - *Couple of adjustable rear view mirrors with adapters*

	CODICE RMS - RMS CODE	COLORE COLOR	LATO SIDE	PASSO THREAD
	12 277 1690	Nero Black	-	Con adattatori With adapters
				



Coppia specchi universali omologati con adattatori - *Couple of adjustable homologated rear view mirrors with adapters*

	CODICE RMS - RMS CODE	COLORE COLOR	LATO SIDE	PASSO THREAD
	12 277 2280	Nero Black	-	Con adattatori With adapters
				

Coppia specchi universali omologati con frecce integrate e adattatori
Couple of adjustable homologated rear view mirrors with blinkers and adapters

	CODICE RMS - RMS CODE	COLORE COLOR	LATO SIDE	PASSO THREAD
	12 277 2290	Nero Black	-	Con adattatori With adapters
				

Coppia specchi tondi universali pieghevoli con adattatori - *Couple of universal rounded folding mirrors and adapters*

	CODICE RMS - RMS CODE	COLORE COLOR	LATO SIDE	PASSO THREAD
	12 277 2250	Nero Black	-	Con adattatori With adapters
				

- Filetto sinistro - *Left Thread*
- Filetto destro - *Right Thread*

SPECCHI RETROVISORI SCOOTER

SCOOTER REAR VIEW MIRRORS



UNIVERSALE - UNIVERSAL

Coppia specchi universali omologati con adattatori - Couple of adjustable homologated rear view mirrors and adapters

	CODICE RMS - RMS CODE	COLORE COLOR	LATO SIDE	PASSO THREAD
	12 277 2330			
		Nero <i>Black</i>	-	Con adattatori <i>With adapters</i>

Coppia specchi universali omologati con adattatori - Couple of adjustable homologated rear view mirrors with adapters

	CODICE RMS - RMS CODE	COLORE COLOR	LATO SIDE	PASSO THREAD
	12 277 2340			
		Cromato <i>Chromed</i>	Destro <i>Right</i>	Con adattatori <i>With adapters</i>

ADATTATORI SPECCHI - MIRROR ADAPTERS

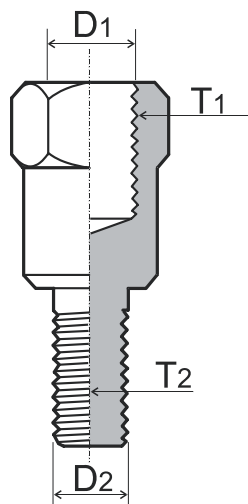

CODICE RMS RMS CODE	BARCODE	Ø D1	T1	D2	T2
12 185 0060		M8		M10	
12 185 0070		M8		M10	
12 185 0080		M8		M8	
12 185 0090		M8		M10	
12 185 0100		M8		M10	
12 185 0110		M8		M8	
12 185 0120		M10		M10	
12 185 0130		M10		M8	
12 185 0140		M10		M8	
12 185 0150		M10		M10	
12 185 0160		M10		M8	
12 185 0170		M10		M8	

12 185 0050

ADATTATORE SPECCHIO - MIRROR ADAPTER
PIAGGIO 125: Beverly Eu3 Mic 07 • Beverly Eu3 Sport 07-08 • Beverly Eu3 07-08 • Beverly Rst 05-07 • Beverly Tourer Eu3 07-10 • Beverly 01-03 • Carnaby 07-10 • **200:** Carnaby 07-08 • **250:** Beverly Eu3 Mic 07 • Beverly le Eu3 06-08 • Beverly Rst 04-05 • Beverly Sport 06-08 • Beverly Tourer Eu3 07-09 • Beverly 06-07 • Carnaby 08 • **300:** Beverly Tourer Eu3 09-10 • **400:** Beverly Eu3 06-07 • Beverly Tourer Eu3 08-10 • X8 Eu3 06-08 • **500:** Beverly Eu3 06-08 • Beverly 02-06 (R.O. 497343)



12 185 0020

ADATTATORE SPECCHIO - MIRROR ADAPTER
APRILIA 50: Mx 04 • Rally Liquid Cooled 96-99 • Rx • Racing • Enduro • Motard 95-06 • Scarabeo 2T Net • 2T Eu 2 Mot. Piaggio • Street 2T Restyling • Scarabeo 4T • 4V • 4V Net • 4T Restyling Eu 3 • Quattro • Ditech 93-11 • **100:** Scarabeo 4T • 4T Net • Net Eu 3 • 4T Restyling 01-10 • Scarabeo Motori Minarelli • Yamaha 00
125: Mx 04-06 • Rx • Sx 94-10



12 185 0040

ADATTATORE SPECCHIO - MIRROR ADAPTER
PIAGGIO: Vespa Px 98-15 (R.O. 622391)



12 185 0180

STAFFA SUPPORTO SPECCHIO
MIRROR HOLDER
PIAGGIO: Vespa Px 125-150-200 77-98





APRILIA

50-125: Tuono 03-04 • **660:** Pegaso - Strada (Fun) - Factory - Trail 05-09 • **1000:** Rsv R Tuono 02-05

	CODICE RMS - RMS CODE	COLORE COLOR	LATO SIDE	PASSO THREAD
	12 277 1230	Nero Black	Destro Right Sinistro Left	10 x 1,25
	R.O. AP8104566			

50: RS 96-10 • **125:** RS 98-10 • **250:** RS 98-03 • **1000:** Rsv 00-03 • SL Falco 00-03

	CODICE RMS - RMS CODE	COLORE COLOR	LATO SIDE	PASSO THREAD
	12 277 0120	Nero Black	Destro Right	Fori passanti Passing holes
	R.O. AP8102632	Nero Black	Sinistro Left	Fori passanti Passing holes
	12 276 0120			
R.O. AP8102633				

450-550: Rsv 06-11 • Sxv 06-11 • **660:** Pegaso Strada (Fun) - Factory Trail 05-09 • **750:** Dorsoduro 08-16 • Shiver 07-16 • Shiver Gt 07-09
 • **850:** Mana 07-11 • Mana Gt 09-16

	CODICE RMS - RMS CODE	COLORE COLOR	LATO SIDE	PASSO THREAD
	12 277 1540	Nero Black	Destro Right	10 x 1,25
	R.O. AP8104921	Nero Black	Sinistro Left	10 x 1,25
	12 276 1540			
R.O. AP8104922				

650: Pegaso 3 97-00 • Pegaso le 01-04 • Pegaso 92-96

	CODICE RMS - RMS CODE	COLORE COLOR	LATO SIDE	PASSO THREAD
	12 277 2020	Nero Black	Destro Right	Perno Ø 10 Ø 10 Pin
	R.O. AP8102324	Nero Black	Sinistro Left	Perno Ø 10 Ø 10 Pin
	12 276 2020			
R.O. AP8102325				





1000: Rsv4 Racing Factory Le 15-16 • Rsv4 Rr Racer Pack 15 • Rsv4 Rr 15

	CODICE RMS - RMS CODE	COLORE COLOR	LATO SIDE	PASSO THREAD
	12 277 2350	Nero Black	Destro Right	2 Perni 6 mm 2 Pins 6 mm
	R.O. 2B001543	Nero Black	Sinistro Left	2 Perni 6 mm 2 Pins 6 mm
	12 276 2350			
R.O. 2B001544				



SPECCHI RETROVISORI MOTO
MOTORCYCLE REAR VIEW MIRRORS

BMW



650: F 650 Gs 08> • G 650 Gs 11> • G 650 X Challenge 09> • **800:** F 800 Gs 08> • F 800 R 08> • **1200:** R 1200 Gs 11-13 • R 1200 Gs Adv 11-13

	CODICE RMS - RMS CODE		COLORE COLOR	LATO SIDE	PASSO THREAD
	12 277 1330				
			Nero Black	Destro Right	10 x 1,25 
	R.O. 51-167-715-864				
	12 276 1330		Nero Black	Sinistro Left	10 x 1,25 
					
R.O. 51-167-715-863					



750: K75 83-88 • K75 C 85-91 • **800:** R80 80-92 • R80 Gs 85-95 • R80 R 91-94 • **1000:** K100 83-88 • K100 Gs 76-84 • K100 R 91-94

	CODICE RMS - RMS CODE		COLORE COLOR	LATO SIDE	PASSO THREAD
	12 277 1280				
					
R.O. 51-161-451-523					



800: F800 S 01-10

	CODICE RMS - RMS CODE		COLORE COLOR	LATO SIDE	PASSO THREAD
	12 277 1880				
			Nero Black	Destro Right	Fori passanti Passing holes
	R.O. 51-16-7-714-112/51-16-8-528-632				
	12 276 1880		Nero Black	Sinistro Left	Fori passanti Passing holes
					
R.O. 51-16-7-714-111/51-16-8-528-631					

1000: S 1000 Rr 09>

	CODICE RMS - RMS CODE		COLORE COLOR	LATO SIDE	PASSO THREAD
	12 277 2370				
			Nero Black	Destro Right	2 Perni 6 mm 2 Pins 6 mm
	R.O. 51-16-7-718-514				
	12 276 2370		Nero Black	Sinistro Left	2 Perni 6 mm 2 Pins 6 mm
					
R.O. 51-16-7-718-513					



1200: R 1200 Gs 02> • R 1200 Gs Adv 05> • R 1200 R 05>

	CODICE RMS - RMS CODE		COLORE COLOR	LATO SIDE	PASSO THREAD
	12 277 1320				
					
R.O. 51-167-705-368 R.O. 51-167-667-717 R.O. 51-167-697-241 R.O. 51-167-699-791					





BMW



1200: R 1200

	CODICE RMS - <i>RMS CODE</i>		COLORE COLOR	LATO SIDE	PASSO THREAD
	12 277 1870				
			Nero Black	Destro Right	Perno Ø 10 Ø 10 Pin
	R.O. 51-16-7-688-655				
	12 276 1870		Nero Black	Sinistro Left	Perno Ø 10 Ø 10 Pin
					
R.O. 51-16-7-688-656					



1200: K 1200 R 09-07

	CODICE RMS - <i>RMS CODE</i>		COLORE COLOR	LATO SIDE	PASSO THREAD
	12 277 2200				
					
R.O. 71-60-7-699-091		Nero Black	Destro Right	Perno Ø 10 Ø 10 Pin	



1200: R 1200 R 09 • 1300: K 1300 R

	CODICE RMS - <i>RMS CODE</i>		COLORE COLOR	LATO SIDE	PASSO THREAD
	12 277 2220				
					
R.O. 51-16-7-686-618		Cromato Chromed	Destro Right	Perno Ø 10 Ø 10 Pin	

1200: K 1200 R 09> • K 1200 R 07> • 1300: K 1300 R 08>

	CODICE RMS - <i>RMS CODE</i>		COLORE COLOR	LATO SIDE	PASSO THREAD
	12 277 1350				
					
R.O. 51-167-685-505		Nero Black	Destro Right Sinistro Left	10 x 1,25 	





1200: R 1200 Rs 14>

	CODICE RMS - <i>RMS CODE</i>		COLORE COLOR	LATO SIDE	PASSO THREAD
	12 277 2380				
					
	R.O. 51-16-8-556-084		Nero Black	Destro Right	3 Fori 6 mm 3 Holes 6 mm
	12 276 2380		Nero Black	Sinistro Left	3 Fori 6 mm 3 Holes 6 mm
					
R.O. 51-16-8-556-083					



SPECCHI RETROVISORI MOTO
MOTORCYCLE REAR VIEW MIRRORS

DUCATI





400: Monster Dark Jap 05 • Monster Dark 05 • Monster 04-08 • **620:** Monster Dark Single Disc 05 • Monster Dark Usa 05-06 • Monster Dark 05-06 • Monster Usa 05-06 • Monster 04-06 • **695:** Monster Usa 07-08 • Monster 07-08 • **800:** Monster 04 • Monster S2R Dark Usa 05-06 • Monster S2R Dark 05-06 • Monster S2R Usa 05-07 • Monster S2R 05-07 • **996:** Monster S4R Usa 05-06 • Monster S4R 03-06 • **1000:** Monster S Usa 05 • Monster S 05 • Monster Usa 05 • Monster 04-05 • Monster S2R Usa 06-08 • Monster S2R 06-08 • Monster S4R Usa 07-08 • Monster S4R 07-08 • Monster S4rs Tricolore Usa 08 • Monster S4rs Tricolore 08 • Monster S4rs Usa 06-08 • Monster S4rs 06-08

	CODICE RMS - RMS CODE		COLORE COLOR	LATO SIDE	PASSO THREAD
	12 277 1370		Nero Black	Destro Right	10 x 1,25 
	 R.O. 52340143A				
	12 276 1370		Nero Black	Sinistro Left	10 x 1,25 
	 R.O. 52340153A				



660: Monster 659 Abs Australia 12 • Monster 659 Australia 12 • **700:** Monster 696 Abs Usa 10-12 • Monster 696 Abs 10-12 • Monster 696 Usa 08-12 • Monster 696 08-12 • **800:** Monster 795 Thai 12 • Monster 795 12 • Monster 796 Abs Usa 11-12 • Monster 796 Abs 11-12 • Monster 796 Usa 11-12 • Monster 796 11-12 • **821:** Hypermotard Bra 14 • Hypermotard Hyperstrada Bra 14 • Hypermotard Hyperstrada Usa 13-14 • Hypermotard Hyperstrada 13-14 • Hypermotard Sp Usa 13-14 • Hypermotard Sp 13-14 • Hypermotard Usa 13-14 • Hypermotard 13-14 • **848:** Streetfighter 848 Usa 12-14 • Streetfighter 848 12-14 • **1098:** Streetfighter S Usa 13 • Streetfighter S 13 • **1100:** Monster Abs Usa 10 • Monster Abs 10 • Monster Evo Abs Usa 12 • Monster Evo Abs 12 • Monster S Abs Usa 10 • Monster S Abs 10 • Monster S Usa 09-10 • Monster S 09-10 • Monster Usa 09-10 • Monster 09-10 • Streetfighter S Usa 10-12 • Streetfighter S 10-12 • Streetfighter Usa • Streetfighter 10-11

	CODICE RMS - RMS CODE		COLORE COLOR	LATO SIDE	PASSO THREAD
	12 277 1380		Nero Black	Destro Right	Foro passante 8 mm Passing Hole 8 mm
	 R.O. 52340222A				
	12 276 1380		Nero Black	Sinistro Left	Foro passante 8 mm Passing Hole 8 mm
	 R.O. 52340232A				

800: Scrambler 15-16 (Tutti i modelli - All Version)

	CODICE RMS - RMS CODE		COLORE COLOR	LATO SIDE	PASSO THREAD
	12 277 2400		Nero Black	Destro Right	10 x 1,25 
	 R.O. 52310491B				
	12 276 2400		Nero Black	Sinistro Left	10 x 1,25 
	 R.O. 52310481B				

821: Monster 15-16 • **1200:** Monster S 15

	CODICE RMS - RMS CODE		COLORE COLOR	LATO SIDE	PASSO THREAD
	12 277 2390		Nero-Grigio Grey-Black	Destro Right	Foro 8 mm Hole 8 mm
	 R.O. 52310442A				
	12 276 2390		Nero-Grigio Grey-Black	Sinistro Left	Foro 8 mm Hole 8 mm
	 R.O. 52310452A				



DUCATI

899: Panigale Abs 14-15 • **1199:** Panigale S, R 12-15

	CODICE RMS - RMS CODE	COLORE COLOR	LATO SIDE	PASSO THREAD
	12 277 2420	Nero <i>Black</i>	Destro <i>Right</i>	2 Fori 6 mm <i>2 Holes 6 mm</i>
	R.O. 523S0281A - 523S0282B 523S0283B	Nero <i>Black</i>	Sinistro <i>Left</i>	2 Fori 6 mm <i>2 Holes 6 mm</i>
	12 276 2420			
R.O. 523S0291A - 523S0292B 523S0293B				

1200: Multistrada 10-14

	CODICE RMS - RMS CODE	COLORE COLOR	LATO SIDE	PASSO THREAD
	12 277 1900	Nero <i>Black</i>	Destro <i>Right</i>	Foro passante 8 mm <i>Passing Hole 8 mm</i>
	R.O. 52310351A	Nero <i>Black</i>	Sinistro <i>Left</i>	Foro passante 8 mm <i>Passing Hole 8 mm</i>
	12 276 1900			
R.O. 52310341A				

1200: Multistrada S 15-16 • Multistrada Abs 15-16 • Multistrada S Abs 15-16 • Multistrada Touring 15-16 • Multistrada S Touring 15-16

	CODICE RMS - RMS CODE	COLORE COLOR	LATO SIDE	PASSO THREAD
	12 277 2410	Nero <i>Black</i>	Destro <i>Right</i>	Foro 10 mm <i>Hole 10 mm</i>
	R.O. 52310462A	Nero <i>Black</i>	Sinistro <i>Left</i>	Foro 10 mm <i>Hole 10 mm</i>
	12 276 2410			
R.O. 52310472A				

GUZZI



750: Nevada Classic 09-13 • Nevada S 10-12 • V7 09-16 • **850:** V9 Roamer 16 • **940:** Bellagio 07-13 • **1100:** California 03-12 • **1200:** Brevia 07 • Griso 07-13 • Norge 06-08

	CODICE RMS - RMS CODE	COLORE COLOR	LATO SIDE	PASSO THREAD
	12 277 0250	Cromato <i>Chromed</i>	Destro <i>Right</i>	10 x 1,25 con adattatore <i>With adapter</i>
	R.O. 978570	Cromato <i>Chromed</i>	Sinistro <i>Left</i>	10 x 1,25 con adattatore <i>With adapter</i>
	12 276 0250			
R.O. 978570				





SPECCHI RETROVISORI MOTO
MOTORCYCLE REAR VIEW MIRRORS

HONDA





125: Varadero 01-06 • Xr 07 • **250:** Ftr • Xr 87-99 • Xr R 86-06 • **400:** Xr R 96-06 • **600:** XL R 94-97 • **650:** Nx Dominator 93-99
Transalp 07 • **750:** XL V

	CODICE RMS - RMS CODE	COLORE COLOR	LATO SIDE	PASSO THREAD
	12 277 1340	Nero Black	Destro Right Sinistro Left	10 x 1,25 
				
	R.O. 88110-KW4-600			





125: Shadow • **250:** Hornet • Vtr 03 • Jazz 04 • **400:** Cb Sf • **500:** Cbf 04 • **600:** Cb F 03-06 • Cbf F Hornet 03-06 • Cbf N • **750** Cb • **1300:** Cb Sf

	CODICE RMS - RMS CODE	COLORE COLOR	LATO SIDE	PASSO THREAD
	12 277 1500	Cromato Chromed	Destro Right	10 x 1,25 
				
	R.O. 88210-MBZ-K00			
	12 276 1500	Cromato Chromed	Sinistro Left	10 x 1,25 
				
R.O. 88220-MBZ-K00				



125: Cb F 09>

	CODICE RMS - RMS CODE	COLORE COLOR	LATO SIDE	PASSO THREAD
	12 277 2270	Nero Black	Destro Right	10 x 1,25 
				
	R.O. 88110-KWF-951			
	12 276 2270	Nero Black	Sinistro Left	10 x 1,25 
				
R.O. 88120-KWF-951				

125: Cb F 15

	CODICE RMS - RMS CODE	COLORE COLOR	LATO SIDE	PASSO THREAD
	12 277 2590	Nero Black	Destro Right	10 x 1,25 
				
	R.O. 88210-KPN-A71			
	12 276 2590	Nero Black	Sinistro Left	10 x 1,25 
				
R.O. 88220-KPN-A71				



250: Xr R 96-06 • **400:** Xr R/Sm 96-06 • **600:** Transalp XL V 87-96 • Xr R 85-00 • **650:** Africa Twin 88-89 • Dominator 88-92 • **750:** Africa Twin 90-92

	CODICE RMS - RMS CODE	COLORE COLOR	LATO SIDE	PASSO THREAD
	12 277 1400	Nero Black	Destro Right Sinistro Left	10 x 1,25 
				
	R.O. 88110-MN9-003			







HONDA



250: Cbr R 14-16 • **300:** Cbr R 15-16

 <p>E-MARK NEW</p>	CODICE RMS - RMS CODE		COLORE COLOR	LATO SIDE	PASSO THREAD
	12 277 2430		Nero Black	Destro Right	2 Fori 6 mm 2 Holes 6 mm
	 R.O. 88110-K33-D01				
	12 276 2430		Nero Black	Sinistro Left	2 Fori 6 mm 2 Holes 6 mm
	 R.O. 88120-K33-D01				



500: Cb S 98-02

 <p>E-MARK</p>	CODICE RMS - RMS CODE		COLORE COLOR	LATO SIDE	PASSO THREAD
	12 277 1930		Cromato Chromed	Destro Right	10 x 1,25 
	 R.O. 88210-MY5-F10				
	12 276 1930		Cromato Chromed	Sinistro Left	10 x 1,25 
	 R.O. 88220-MY5-F10				



500: Cbr R 13-15

 <p>E-MARK NEW</p>	CODICE RMS - RMS CODE		COLORE COLOR	LATO SIDE	PASSO THREAD
	12 277 2460		Nero Black	Destro Right	2 Fori 6 mm 2 Holes 6 mm
	 R.O. 88110-MGZ-J01				
	12 276 2460		Nero Black	Sinistro Left	2 Fori 6 mm 2 Holes 6 mm
	 R.O. 88120-MGZ-J01				

600: Cbr F 06 • Cb F Hornet S 02 • **1000:** Vtr Sp1

 <p>E-MARK</p>	CODICE RMS - RMS CODE		COLORE COLOR	LATO SIDE	PASSO THREAD
	12 277 1250		Nero Black	Destro Right	2 Fori M6 2 Holes M6
	 R.O. 88110-MBW-003				
	12 276 1250		Nero Black	Sinistro Left	2 Fori M6 2 Holes M6
	 R.O. 88120-MBW-003				





600: Cbr RR 07-13 • Cbr F/FA 11 • **1000:** Cbr RR 04-07

 <p>E-MARK</p>	CODICE RMS - RMS CODE		COLORE COLOR	LATO SIDE	PASSO THREAD
	12 277 1310		Nero Black	Destro Right	2 Fori M6 2 Holes M6
	 R.O. 88110-MEL-003/013				
	12 276 1310		Nero Black	Sinistro Left	2 Fori M6 2 Holes M6
	 R.O. 88120-MEL-003/013				



SPECCHI RETROVISORI MOTO
MOTORCYCLE REAR VIEW MIRRORS

HONDA



600: Cb F Hornet • Abs 07-10

 E-MARK	CODICE RMS - RMS CODE		COLORE COLOR	LATO SIDE	PASSO THREAD
	12 277 0280		Nero Black	Destro Right	Con adattatore With adaptor 10 x 1,25 
	 R.O. 88110-MFG-D00				
	12 276 0280		Nero Black	Sinistro Left	Con adattatore With adaptor 10 x 1,25 
 R.O. 88120-MFG-D00					





600: Cbf S 08-10 • 1000: Cbf Sf 07-11

 E-MARK	CODICE RMS - RMS CODE		COLORE COLOR	LATO SIDE	PASSO THREAD
	12 277 2170		Nero Black	Destro Right	Fori passanti Passing holes
	 R.O. 88110-MER-R01				
	12 276 2170		Nero Black	Sinistro Left	Fori passanti Passing holes
 R.O. 88120-MER-R01					



600: Cbf S 04-05

 E-MARK	CODICE RMS - RMS CODE		COLORE COLOR	LATO SIDE	PASSO THREAD
	12 277 2040		Nero Black	Destro Right	Fori passanti Passing holes
	 R.O. 88110-MER-D00				
	12 276 2040		Nero Black	Sinistro Left	Fori passanti Passing holes
 R.O. 88120-MER-D00					

650: Cb Fa 14>

 E-MARK NEW	CODICE RMS - RMS CODE		COLORE COLOR	LATO SIDE	PASSO THREAD
	12 277 2440		Nero Black	Destro Right	10 x 1,25 
	 R.O. 88210-MJE-D40				
	12 276 2440		Nero Black	Sinistro Left	10 x 1,25 
 R.O. 88220-MJE-D40					



650: Cbr F 14>

 E-MARK NEW	CODICE RMS - RMS CODE		COLORE COLOR	LATO SIDE	PASSO THREAD
	12 277 2450		Nero Black	Destro Right	2 Fori 6 mm 2 Holes 6 mm
	 R.O. 88110-MJE-D01				
	12 276 2450		Nero Black	Sinistro Left	2 Fori 6 mm 2 Holes 6 mm
 R.O. 88120-MJE-D01					







HONDA





700: Deauville 10-11 • Nt V 06-08

 E-MARK	CODICE RMS - RMS CODE		COLORE COLOR	LATO SIDE	PASSO THREAD
	12 277 2180		Nero Black	Destro Right	Fori passanti Passing holes
	 R.O. 88110-MEW-921				
	12 276 2180		Nero Black	Sinistro Left	Fori passanti Passing holes
 R.O. 88120-MEW-921					



750: Africa Twin Xrv 93-02 • **1000:** Varadero XLV 99-10

 E-MARK	CODICE RMS - RMS CODE		COLORE COLOR	LATO SIDE	PASSO THREAD
	12 277 1390		Nero Black	Destro Right	10 x 1,25 
	 R.O. 88210-MY1-003				
	12 276 1390		Nero Black	Sinistro Left	10 x 1,25 
 R.O. 88220-MY1-003					



750: Vt S 10 • Vt Sb 11 • **1300:** Vt Csa 11

 E-MARK	CODICE RMS - RMS CODE		COLORE COLOR	LATO SIDE	PASSO THREAD
	12 277 2080		Cromato Chromed	Destro Right	10 x 1,25 
	 R.O. 88210-MGR-641				
	12 276 2080		Cromato Chromed	Sinistro Left	10 x 1,25 
 R.O. 88220-MGR-641					

800: Vfr 00-01

 E-MARK	CODICE RMS - RMS CODE		COLORE COLOR	LATO SIDE	PASSO THREAD
	12 277 2120		Nero Black	Destro Right	Fori passanti Passing holes
	 R.O. 88110-MBG-D01				
	12 276 2120		Nero Black	Sinistro Left	Fori passanti Passing holes
 R.O. 88120-MBG-D01					



800: Vfr 02-09

 E-MARK	CODICE RMS - RMS CODE		COLORE COLOR	LATO SIDE	PASSO THREAD
	12 277 1940		Nero Black	Destro Right	Fori passanti Passing holes
	 R.O. 88110-MCW-D01				
	12 276 1940		Nero Black	Sinistro Left	Fori passanti Passing holes
 R.O. 88120-MCW-D01					



SPECCHI RETROVISORI MOTO
MOTORCYCLE REAR VIEW MIRRORS

HONDA





900: Cbr R 00-01

	CODICE RMS - RMS CODE		COLORE COLOR	LATO SIDE	PASSO THREAD
	12 277 2140		Nero Black	Destro Right	Fori passanti Passing holes
	 R.O. 88110-MCJ-003				
	12 276 2140		Nero Black	Sinistro Left	Fori passanti Passing holes
	 R.O. 88120-MCJ-003				

1000: Cbr Rr 08-13



	CODICE RMS - RMS CODE		COLORE COLOR	LATO SIDE	PASSO THREAD
	12 277 1810		Nero Black	Destro Right	Perni M6 M6 Pins
	 R.O. 88110-MFL-003				
	12 276 1810		Nero Black	Sinistro Left	Perni M6 M6 Pins
	 R.O. 88120-MFL-003				

1200: Vfr X Crosstourer 13-14

	CODICE RMS - RMS CODE		COLORE COLOR	LATO SIDE	PASSO THREAD
	12 277 1410		Nero Black	Destro Right	12 x 1,25 
	 R.O. 88210-MGH-640				
	12 276 1410		Nero Black	Sinistro Left	12 x 1,25 
	 R.O. 88220-MGH-640				

HUSQVARNA



125: Wre - Sm S 00-08

	CODICE RMS - RMS CODE		COLORE COLOR	LATO SIDE	PASSO THREAD
	12 277 2210		Nero Black	Destro Right	10 x 1,25 
	 R.O. 8000-58378				







KAWASAKI



250: Ninja R 08-10 • Ninja R 11-12

	CODICE RMS - RMS CODE	COLORE COLOR	LATO SIDE	PASSO THREAD
	12 277 2150	Nero Black	Destro Right	Perni M6 M6 Pins
				
	R.O. 56001-0099	Nero Black	Sinistro Left	Perni M6 M6 Pins
12 276 2150				
	R.O. 56001-0098			



250: Z SL Abs 15 • Z SL 15 • **800:** Z Abs 13-16 • Z 13-16 • Z E Abs 13-16 • Z E 13-16

	CODICE RMS - RMS CODE	COLORE COLOR	LATO SIDE	PASSO THREAD
	12 277 2510	Nero Black	Destro Right	10x1,25 
				
	R.O. 560010244	Nero Black	Sinistro Left	10x1,25 
12 276 2510				
	R.O. 560010243			



250: Ninja SL Abs 15 • Ninja SL 15 • **300:** Ninja Abs 13-16 • Ninja 13-15

	CODICE RMS - RMS CODE	COLORE COLOR	LATO SIDE	PASSO THREAD
	12 277 2500	Nero Black	Destro Right	2 Fori 6 mm 2 Holes 6 mm
				
	R.O. 560010240	Nero Black	Sinistro Left	2 Fori 6 mm 2 Holes 6 mm
12 276 2500				
	R.O. 560010239			

600: Ninja Zx-6R 09-16

	CODICE RMS - RMS CODE	COLORE COLOR	LATO SIDE	PASSO THREAD
	12 277 2300	Nero Black	Destro Right	2 Fori 6 mm 2 Holes 6 mm
				
	R.O. 560010147	Nero Black	Sinistro Left	2 Fori 6 mm 2 Holes 6 mm
12 276 2300				
	R.O. 560010146			





636: Ninja Zx-6R Abs 13-16 • Ninja Zx-6R 13-16

	CODICE RMS - RMS CODE	COLORE COLOR	LATO SIDE	PASSO THREAD
	12 277 2470	Nero Black	Destro Right	2 Fori 6 mm 2 Holes 6 mm
				
	R.O. 560010246	Nero Black	Sinistro Left	2 Fori 6 mm 2 Holes 6 mm
12 276 2470				
	R.O. 560010245			



SPECCHI RETROVISORI MOTO
MOTORCYCLE REAR VIEW MIRRORS

KAWASAKI



650: Er-6N 06-08 • Er-6N Abs 06-08 • KLE Versys 07-09 • KLE Versys Abs 07-09

 <p>E-MARK</p>	CODICE RMS - RMS CODE		COLORE COLOR	LATO SIDE	PASSO THREAD
	12 277 1290				
	 R.O. 560010145		Nero Black	Destro Right	10 x 1,25 
	12 276 1290				
	 R.O. 560010144		Nero Black	Sinistro Left	10 x 1,25 





650: Er 6F 06-08 • Er 6F Abs 06-08

 <p>E-MARK</p>	CODICE RMS - RMS CODE		COLORE COLOR	LATO SIDE	PASSO THREAD
	12 277 1910				
	 R.O. 560010044		Nero Black	Destro Right	Perni M6 M6 Pins
	12 276 1910				
	 R.O. 560010043		Nero Black	Sinistro Left	Perni M6 M6 Pins





650: Er 6F Abs 09-11 • Er 6F 09-11

 <p>E-MARK</p>	CODICE RMS - RMS CODE		COLORE COLOR	LATO SIDE	PASSO THREAD
	12 277 1850				
	 R.O. 560010142		Nero Black	Destro Right	Perni M6 M6 Pins
	12 276 1850				
	 R.O. 560010143		Nero Black	Sinistro Left	Perni M6 M6 Pins

650: KLE Versys Abs 11-16 • KLE Versys 11-16

 <p>E-MARK NEW</p>	CODICE RMS - RMS CODE		COLORE COLOR	LATO SIDE	PASSO THREAD
	12 277 2490				
	 R.O. 560010195		Nero Black	Destro Right	10 x 1,25 
	12 276 2490				
	 R.O. 560010194		Nero Black	Sinistro Left	10 x 1,25 



650: Er-6N Abs 12-16 • Er-6N 12-16

 <p>E-MARK NEW</p>	CODICE RMS - RMS CODE		COLORE COLOR	LATO SIDE	PASSO THREAD
	12 277 2480				
	 R.O. 560010273		Nero Black	Destro Right	10 x 1,25 
	12 276 2480				
	 R.O. 560010272		Nero Black	Sinistro Left	10 x 1,25 







KAWASAKI





650: Er 6F Abs 12-16 • Er 6F 12-16

	CODICE RMS - RMS CODE		COLORE COLOR	LATO SIDE	PASSO THREAD
	12 277 2630				
			Nero Black	Destro Right	2 Perni 6 mm 2 Pins 6 mm
	R.O. 560010275				
	12 276 2630		Nero Black	Sinistro Left	2 Perni 6 mm 2 Pins 6 mm
					
R.O. 560010274					



750: Z 750 Abs 07-10 • Z 750 07-10 • **1000:** Z 1000 Abs 07-09 • Z 1000 07-09

	CODICE RMS - RMS CODE		COLORE COLOR	LATO SIDE	PASSO THREAD
	12 277 1270				
			Nero Black	Destro Right	10 x 1,25 
	R.O. 560010118				
	12 276 1270		Nero Black	Sinistro Left	10 x 1,25 
					
R.O. 560010117					



750: Z 750 04-05 • Z 750 06 • **1000:** Z 1000 03-05 • Z 1000 06

	CODICE RMS - RMS CODE		COLORE COLOR	LATO SIDE	PASSO THREAD
	12 277 1300				
			Nero Black	Destro Right	10 x 1,25 
	R.O. 560010031				
	12 276 1300		Nero Black	Sinistro Left	10 x 1,25 
					
R.O. 560010030					

1000: Ninja Zx-10R Abs 11-15 • Ninja Zx-10R 11-15

	CODICE RMS - RMS CODE		COLORE COLOR	LATO SIDE	PASSO THREAD
	12 277 2310				
			Nero Black	Destro Right	2 Fori 6 mm 2 Holes 6 mm
	R.O. 560010289				
	12 276 2310		Nero Black	Sinistro Left	2 Fori 6 mm 2 Holes 6 mm
					
R.O. 560010288					





1000: Z Sx Abs 14-16 • Z Sx 14-16

	CODICE RMS - RMS CODE		COLORE COLOR	LATO SIDE	PASSO THREAD
	12 277 2520				
			Nero Black	Destro Right	2 Perni 6 mm 2 Pins 6 mm
	R.O. 560010260				
	12 276 2520		Nero Black	Sinistro Left	2 Perni 6 mm 2 Pins 6 mm
					
R.O. 560010259					





SPECCHI RETROVISORI MOTO
MOTORCYCLE REAR VIEW MIRRORS

KAWASAKI



1000: KLZ Versys 15-16

 <p>E-MARK NEW</p>	CODICE RMS - RMS CODE		COLORE COLOR	LATO SIDE	PASSO THREAD
	12 277 2600		Nero Black	Destro Right	10 x 1,25 
	 R.O. 560010298				
	12 276 2600		Nero Black	Sinistro Left	10 x 1,25 
	 R.O. 560010297				

1000: Z Abs 10-13 • Z 10-13

 <p>E-MARK NEW</p>	CODICE RMS - RMS CODE		COLORE COLOR	LATO SIDE	PASSO THREAD
	12 277 2610		Nero Black	Destro Right	10 x 1,25 
	 R.O. 560010216				
	12 276 2610		Nero Black	Sinistro Left	10 x 1,25 
	 R.O. 560010215				



1000: Zsx Abs 11-13 • Z 11-13

 <p>E-MARK NEW</p>	CODICE RMS - RMS CODE		COLORE COLOR	LATO SIDE	PASSO THREAD
	12 277 2620		Nero Black	Destro Right	2 Pemi 6 mm 2 Pins 6 mm
	 R.O. 560010232				
	12 276 2620		Nero Black	Sinistro Left	2 Pemi 6 mm 2 Pins 6 mm
	 R.O. 560010231				





MV AGUSTA



900: Brutale 989R-1078Rr 08 • **910:** Brutale 05-08

	CODICE RMS - <i>RMS CODE</i>	COLORE COLOR	LATO SIDE	PASSO THREAD
	12 277 2090	Nero <i>Black</i>	Destro <i>Right</i>	Foro passante 8 mm <i>Passing Hole 8 mm</i>
	 R.O. 80B098338			
	12 276 2090	Nero <i>Black</i>	Sinistro <i>Left</i>	Foro passante 8 mm <i>Passing Hole 8 mm</i>
	 R.O. 80B098339			

920: Brutale 920-990R-1090Rr 10-11

	CODICE RMS - <i>RMS CODE</i>	COLORE COLOR	LATO SIDE	PASSO THREAD
	12 277 1820	Nero <i>Black</i>	Destro <i>Right</i>	Foro passante 8 mm <i>Passing Hole 8 mm</i>
	 R.O. 8000B1658			
	12 276 1820	Nero <i>Black</i>	Sinistro <i>Left</i>	Foro passante 8 mm <i>Passing Hole 8 mm</i>
	 R.O. 8000B1659			





1000: F4 04-06

	CODICE RMS - <i>RMS CODE</i>	COLORE COLOR	LATO SIDE	PASSO THREAD
	12 277 1920	Nero <i>Black</i>	Destro <i>Right</i>	2 Fori 6 mm <i>2 Holes 6 mm</i>
	 R.O. 80B0A3229			
	12 276 1920	Nero <i>Black</i>	Sinistro <i>Left</i>	2 Fori 6 mm <i>2 Holes 6 mm</i>
	 R.O. 80B0A3228			



SPECCHI RETROVISORI MOTO
MOTORCYCLE REAR VIEW MIRRORS

SUZUKI



600: Gsr 06-10 - **650:** Gsf Bandit 05-06

 <p>E-MARK</p>	CODICE RMS - RMS CODE		COLORE COLOR	LATO SIDE	PASSO THREAD
	12 277 1440		Nero Black	Destro Right	10 x 1,25 
	 R.O. 56500-38G10-11				
	12 276 1440		Nero Black	Sinistro Left	10 x 1,25 
	 R.O. 56600-38G10-11				





600: Gsx-R600 01-03 • **750:** Gsx-R750 00-03 • **1000:** Gsx-R1000 01-02

 <p>E-MARK</p>	CODICE RMS - RMS CODE		COLORE COLOR	LATO SIDE	PASSO THREAD
	12 277 1990		Nero Black	Destro Right	Fori passanti Passing holes
	 R.O. 56500-40F10-000				
	12 276 1990		Nero Black	Sinistro Left	Fori passanti Passing holes
	 R.O. 56600-40F10-000				





600: Gsf Bandit 00-04 • **1200:** Gsf Bandit 01-05

 <p>E-MARK</p>	CODICE RMS - RMS CODE		COLORE COLOR	LATO SIDE	PASSO THREAD
	12 277 1840		Nero Black	Destro Right	Perni M6 M6 Pins
	 R.O. 56500-31F00				
	12 276 1840		Nero Black	Sinistro Left	Perni M6 M6 Pins
	 R.O. 56600-31F00				

650: DL V-Strom 04-06 • DL V-Strom 07-10 • DL V-Strom 11 • **1000:** DL V-Strom 02-06 • DL V-Strom 07-10

 <p>E-MARK</p>	CODICE RMS - RMS CODE		COLORE COLOR	LATO SIDE	PASSO THREAD
	12 277 1420		Nero Black	Destro Right	10 x 1,25 
	 R.O. 56500-04F23-000				
	12 276 1420		Nero Black	Sinistro Left	10 x 1,25 
	 R.O. 56600-04F23-000				





650: Sfv Gladius 09-11 • **1300:** B-King 08-10

 <p>E-MARK</p>	CODICE RMS - RMS CODE		COLORE COLOR	LATO SIDE	PASSO THREAD
	12 277 1450		Cromato Chromed	Destro Right	10 x 1,25 
	 R.O. 56500-41F40-000				
	12 276 1450		Cromato Chromed	Sinistro Left	10 x 1,25 
	 R.O. 56600-41F40-000				





SUZUKI



650: Gsf Bandit 09-12

 <p>E-MARK</p>	CODICE RMS - RMS CODE		COLORE COLOR	LATO SIDE	PASSO THREAD
	12 277 1960				
			Nero Black	Destro Right	10 x 1,25 
	R.O. 56500-44G10-000				
	12 276 1960		Nero Black	Sinistro Left	10 x 1,25 
					
R.O. 56600-44G10-000					



650: Gsf Bandit 07-08 • Gsx F 08-10 • **1200:** Gsf 06 • **1250:** Gsf Bandit 07-10 • Gsf S Bandit 11-12

 <p>E-MARK</p>	CODICE RMS - RMS CODE		COLORE COLOR	LATO SIDE	PASSO THREAD
	12 277 1980				
			Nero Black	Destro Right	Fori passanti Passing holes
	R.O. 56500-38G21-000				
	12 276 1980		Nero Black	Sinistro Left	Fori passanti Passing holes
					
R.O. 56600-38G21-000					



650: Gsf Bandit 05-06

 <p>E-MARK</p>	CODICE RMS - RMS CODE		COLORE COLOR	LATO SIDE	PASSO THREAD
	12 277 2130				
			Nero Black	Destro Right	Fori passanti Passing holes
	R.O. 56500-38G00-000				
	12 276 2130		Nero Black	Sinistro Left	Fori passanti Passing holes
					
R.O. 56600-38G00-000					

650: Sv 03-10 • Sv SL 15 • **1000:** Sv 03-07 • Gsx R 03-04

 <p>E-MARK</p>	CODICE RMS - RMS CODE		COLORE COLOR	LATO SIDE	PASSO THREAD
	12 277 2160				
			Nero Black	Destro Right	Fori passanti Passing holes
	R.O. 56500-16G10-000				
	12 276 2160		Nero Black	Sinistro Left	Fori passanti Passing holes
					
R.O. 56600-16G10-000					



650: Sv 99-02

 <p>E-MARK</p>	CODICE RMS - RMS CODE		COLORE COLOR	LATO SIDE	PASSO THREAD
	12 277 1800				
			Nero Black	Destro Right	Perni M6 M6 Pins
	R.O. 56500-19F00-000				
	12 276 1800		Nero Black	Sinistro Left	Perni M6 M6 Pins
					
R.O. 56600-19F00-000					





SPECCHI RETROVISORI MOTO
MOTORCYCLE REAR VIEW MIRRORS

SUZUKI



650: Gsx F 11-12 • **1250:** Gsf S Bandit 16 • Gsx F 10-16

 <p>E-MARK NEW</p>	CODICE RMS - RMS CODE	COLORE COLOR	LATO SIDE	PASSO THREAD
	12 277 2640	Nero Black	Destro Right	2 Fori 6 mm 2 Holes 6 mm
				
	R.O. 56500-18H00-000	Nero Black	Sinistro Left	2 Fori 6 mm 2 Holes 6 mm
	12 276 2640			
				
R.O. 56600-18H00-000				



750: Gsr 11-15

 <p>E-MARK</p>	CODICE RMS - RMS CODE	COLORE COLOR	LATO SIDE	PASSO THREAD
	12 277 1430	Nero Black	Destro Right	10 x 1,25 
				
	R.O. 56500-08J00-000	Nero Black	Sinistro Left	10 x 1,25 
	12 276 1430			
				
R.O. 56600-08J00-000				

750: Gsx R 04-05

 <p>E-MARK</p>	CODICE RMS - RMS CODE	COLORE COLOR	LATO SIDE	PASSO THREAD
	12 277 1970	Nero Black	Destro Right	Fori passanti Passing holes
				
	R.O. 56500-29G10-000	Nero Black	Sinistro Left	Fori passanti Passing holes
	12 276 1970			
				
R.O. 56600-29G10-000				



1300: Hayabusa 04-11 • Hayabusa X-R3 99-03

 <p>E-MARK</p>	CODICE RMS - RMS CODE	COLORE COLOR	LATO SIDE	PASSO THREAD
	12 277 2030	Nero Black	Destro Right	Fori passanti Passing holes
				
	R.O. 56500-24F20-000	Nero Black	Sinistro Left	Fori passanti Passing holes
	12 276 2030			
				
R.O. 56600-24F20-000				





TRIUMPH



675: Daytona

	CODICE RMS - RMS CODE		COLORE COLOR	LATO SIDE	PASSO THREAD
	12 277 1830				
			Nero Black	Destro Right	Perni M6 M6 Pins
	R.O. 2066706				
	12 276 1830		Nero Black	Sinistro Left	Perni M6 M6 Pins
					
R.O. 2066705					



865: Speedmaster • 1700: Thunderbird • 2300: Rocket 3

	CODICE RMS - RMS CODE		COLORE COLOR	LATO SIDE	PASSO THREAD
	12 277 1860				
			Cromato Chromed	Destro Right	Perno Ø 11 Ø 11 Pin
	R.O. 2060060				
	12 276 1860		Cromato Chromed	Sinistro Left	Perno Ø 11 Ø 11 Pin
					
R.O. 2060061					

600: Speed Four 03 - 955-1150: Speed Triple 02-07





	CODICE RMS - RMS CODE		COLORE COLOR	LATO SIDE	PASSO THREAD			
	12 277 1470							
						Nero Black	Destro Right Sinistro Left	10 x 1,25 
	R.O. 1829158							

675: Street Triple 12-14

	CODICE RMS - RMS CODE		COLORE COLOR	LATO SIDE	PASSO THREAD
	12 277 1460				
			Nero Black	Destro Right	Foro passante Passing hole
	R.O. 2066711				
	12 276 1460		Nero Black	Sinistro Left	Foro passante Passing hole
					
R.O. 2066710					





YAMAHA

50: Dt R 06 • Dt X 06 • 125: Xt R 05-08 • Xt X 05-08



	CODICE RMS - RMS CODE		COLORE COLOR	LATO SIDE	PASSO THREAD
	12 277 2650				
			Nero Black	Destro Right	8 x 1,25 
	R.O. 1D4F62800000				
	12 276 2650		Nero Black	Sinistro Left	10 x 1,25 
					
R.O. 1D4F62900000					

YAMAHA





125: Dt • X-Re 04-06 • 250: Xg Tricker 05->

	CODICE RMS - RMS CODE		COLORE COLOR	LATO SIDE	PASSO THREAD
	12 277 0570		Nero asta cromata Black with Chromed shaft	Destro Right	10 X 1,25 
	 R.O. 1D0F629000				
	12 276 0570		Nero asta cromata Black with Chromed	Sinistro Left	10 X 1,25 
	 R.O. 1D0F628000				



125: Yzf-R 08-16

	CODICE RMS - RMS CODE		COLORE COLOR	LATO SIDE	PASSO THREAD
	12 277 2010		Nero Black	Destro Right	Fori passanti Passing holes
	 R.O. 5D7F62900100				
	12 276 2010		Nero Black	Sinistro Left	Fori passanti Passing holes
	 R.O. 5D7F62800100				



125: Ybr 05 - 660: Mt-03 06-12 • Xt R 04-14 • Xt X 04-05 • Xt Z Tenere 08-15

	CODICE RMS - RMS CODE		COLORE COLOR	LATO SIDE	PASSO THREAD
	12 277 1480		Nero Black	Destro Right	10 x 1,25 
	 R.O. 5VKF629000				
	12 276 1480		Nero Black	Sinistro Left	10 x 1,25 
	 R.O. 5VKF628000				

320: Yzf-R3A 15-16

	CODICE RMS - RMS CODE		COLORE COLOR	LATO SIDE	PASSO THREAD
	12 277 2560		Nero Black	Destro Right	2Fori 6 mm 2Holes 6 mm
	 R.O. 1WDF62901000				
	12 276 2560		Nero Black	Sinistro Left	2Fori 6 mm 2Holes 6 mm
	 R.O. 1WDF62801000				





600: Fz6 Fazer 07-08

	CODICE RMS - RMS CODE		COLORE COLOR	LATO SIDE	PASSO THREAD
	12 277 1950		Nero Black	Destro Right	Perni M6 M6 Pins
	 R.O. 458262900000				
	12 276 1950		Nero Black	Sinistro Left	Perni M6 M6 Pins
	 R.O. 458262800000				







YAMAHA





600: Xj6-N Sp 13 • Xj6-N 09-13 • Xj6-Na Abs 15 • 800: Fz8-N 11-12 • Fz8-Na 11-12

 <p>E-MARK</p>	CODICE RMS - RMS CODE		COLORE COLOR	LATO SIDE	PASSO THREAD
	12 277 1360				
			Nero Black	Destro Right	10 x 1,25 
	R.O. 205262900000				
	12 276 1360		Nero Black	Sinistro Left	10 x 1,25 
					
R.O. 205262800000					



600: Fz6 Ns 05-06 • Fz6 S2 07-08 • Fz6 04-07

 <p>E-MARK</p>	CODICE RMS - RMS CODE		COLORE COLOR	LATO SIDE	PASSO THREAD
	12 277 1530				
			Cromato Chromed	Destro Right	10 x 1,25 
	R.O. 1B3262901000				
	12 276 1530		Cromato Chromed	Sinistro Left	10 x 1,25 
					
R.O. 1B3262801000					





660: Xt X 04-14

 <p>E-MARK</p>	CODICE RMS - RMS CODE		COLORE COLOR	LATO SIDE	PASSO THREAD
	12 277 1490				
			Nero Black	Destro Right	10 x 1,25 
	R.O. 1D2F62900000				
	12 276 1490		Nero Black	Sinistro Left	10 x 1,25 
					
R.O. 1D2F62800000					

600: Fzs Fazer 02-03 • 1000: Fzs Fazer 01-05

 <p>E-MARK</p>	CODICE RMS - RMS CODE		COLORE COLOR	LATO SIDE	PASSO THREAD
	12 277 2110				
			Nero Black	Destro Right	Perni M6 M6 Pins
	R.O. 5LV262900000				
	12 276 2110		Nero Black	Sinistro Left	Perni M6 M6 Pins
					
R.O. 5LV262800000					



600: Xj N 95-01 • Xj S Diversion 92-02

 <p>E-MARK</p>	CODICE RMS - RMS CODE		COLORE COLOR	LATO SIDE	PASSO THREAD
	12 277 2230				
			Nero Black	Destro Right	10 x 1,25 
	R.O. 4BR262900000				
	12 276 2230		Nero Black	Sinistro Left	10 x 1,25 
					
R.O. 4BR262800000					





SPECCHI RETROVISORI MOTO
MOTORCYCLE REAR VIEW MIRRORS

YAMAHA



600: Xj6-F Diversion 10-11 • Xj6-Fa Diversion Abs 10-11

 <p>E-MARK</p>	CODICE RMS - RMS CODE		COLORE COLOR	LATO SIDE	PASSO THREAD
	12 277 1890				
	 R.O. 36P26290000		Nero Black	Destro Right	Perni M6 M6 Pins
	12 276 1890				
	 R.O. 36P26280000		Nero Black	Sinistro Left	Perni M6 M6 Pins
	R.O. 36P26280000				





320: Mt-03 16 • **700:** Mt-07 14-16 • **850:** Mt-09 14-16

 <p>E-MARK</p>	CODICE RMS - RMS CODE		COLORE COLOR	LATO SIDE	PASSO THREAD
	12 277 1750				
	 R.O. 1RC262800000		Nero Black	Destro Right	10 x 1,25 
	12 276 1750				
	 R.O. 1RC262900000		Nero Black	Sinistro Left	10 x 1,25 
	R.O. 1RC262900000				





800: Fz8-S 11-15 • Fz8-Sa 11-15

 <p>E-MARK</p>	CODICE RMS - RMS CODE		COLORE COLOR	LATO SIDE	PASSO THREAD
	12 277 2060				
	 R.O. 42P262900000		Nero Black	Destro Right	Perni M6 M6 Pins
	12 276 2060				
	 R.O. 42P262800000		Nero Black	Sinistro Left	Perni M6 M6 Pins
	R.O. 42P262800000				

850: Tdm 00-01 • **900:** Tdm Abs 06-10 • Tdm 06-10

 <p>E-MARK</p>	CODICE RMS - RMS CODE		COLORE COLOR	LATO SIDE	PASSO THREAD
	12 277 1220				
	 R.O. 4TX2628 5000		Nero Black	Destro Right	10 x 1,25 
	12 276 1220				
	 R.O. 4TX2629 5000		Nero Black	Sinistro Left	10 x 1,25 
	R.O. 4TX2629 5000				





850: Tdm 91-98

 <p>E-MARK</p>	CODICE RMS - RMS CODE		COLORE COLOR	LATO SIDE	PASSO THREAD
	12 277 2100				
	 R.O. 3VD262900100		Nero Black	Destro Right	10 x 1,25 
	12 276 2100				
	 R.O. 4TX262800000		Nero Black	Sinistro Left	10 x 1,25 
	R.O. 4TX262800000				







YAMAHA



1000: Fz1 08-09 • **1700:** Mt-01 07-09 • Mt-01S 09

 <p>E-MARK</p>	CODICE RMS - <i>RMS CODE</i>		COLORE COLOR	LATO SIDE	PASSO THREAD
	12 277 1240				
	 R.O. 5YU262902000-2100-3000		Nero Black	Destro Right	10 x 1,25 
	12 276 1240				
	 R.O. 5YU262802000-2100-3000		Nero Black	Sinistro Left	10 x 1,25 
	12 276 1240				
R.O. 5YU262802000-2100-3000					



1000: Fz1 06-07

 <p>E-MARK</p>	CODICE RMS - <i>RMS CODE</i>		COLORE COLOR	LATO SIDE	PASSO THREAD
	12 277 1260				
	 R.O. 2D1262900100		Cromato Chromed	Destro Right	10 x 1,25 
	12 276 1260				
	 R.O. 2D1262800100		Cromato Chromed	Sinistro Left	10 x 1,25 
	12 276 1260				
R.O. 2D1262800100					





1000: Yzf-R1 04-06 • Yzf-R1 Sp 06

 <p>E-MARK</p>	CODICE RMS - <i>RMS CODE</i>		COLORE COLOR	LATO SIDE	PASSO THREAD
	12 277 2000				
	 R.O. 5VY262900000		Nero Black	Destro Right	Perni M6 M6 Pins
	12 276 2000				
	 R.O. 5VY262800000		Nero Black	Sinistro Left	Perni M6 M6 Pins
	12 276 2000				
R.O. 5VY262800000					

1000: Fz1 Fazer Abs 07-08 • Fz1 Fazer 06-10



 <p>E-MARK</p>	CODICE RMS - <i>RMS CODE</i>		COLORE COLOR	LATO SIDE	PASSO THREAD
	12 277 2070				
	 R.O. 3C3262900000		Nero Black	Destro Right	Perni M6 M6 Pins
	12 276 2070				
	 R.O. 3C3262800000		Nero Black	Sinistro Left	Perni M6 M6 Pins
	12 276 2070				
R.O. 3C3262800000					

1200: Xt Z Super tenere 14-15 • Xt Ze Super tenere 14-15



 <p>E-MARK NEW</p>	CODICE RMS - <i>RMS CODE</i>		COLORE COLOR	LATO SIDE	PASSO THREAD
	12 277 2570				
	 R.O. 2B5262900000		Nero Black	Destro Right	10 x 1,25 
	12 276 2570				
	 R.O. 2B5262800000		Nero Black	Sinistro Left	10 x 1,25 
	12 276 2570				
R.O. 2B5262800000					

UNIVERSALE - UNIVERSAL



Specchio tondo universale pieghevole - Universal rounded folding mirror

	CODICE RMS - RMS CODE	COLORE COLOR	LATO SIDE	PASSO THREAD
	12 276 1000	Nero Black	Destro Right Sinistro Left	-
				

Specchio universale "end bar" alluminio nero - Universal "end bar" black rear view mirror

	CODICE RMS - RMS CODE	COLORE COLOR	LATO SIDE	PASSO THREAD
	12 277 1510	Nero Black	Destro Right Sinistro Left	Ø 22
				

Specchio universale cromato - Universal chromed rear view mirror

	CODICE RMS - RMS CODE	COLORE COLOR	LATO SIDE	PASSO THREAD
	12 277 2190	Cromato Chromed	Destro Right Sinistro Left	-
				



Coppia specchi universali con adattatori - Couple of adjustable rear view mirrors with adapters

	CODICE RMS - RMS CODE	COLORE COLOR	LATO SIDE	PASSO THREAD
	12 277 1690	Nero Black	-	Con adattatori With adapters
				

Coppia specchi universali omologati con adattatori - Couple of adjustable homologated rear view mirrors with adapters

	CODICE RMS - RMS CODE	COLORE COLOR	LATO SIDE	PASSO THREAD
	12 277 2280	Nero Black	-	Con adattatori With adapters
				

**Coppia specchi universali omologati con frecce integrate e adattatori
 Couple of adjustable homologated rear view mirrors with blinkers with adapters**

	CODICE RMS - RMS CODE	COLORE COLOR	LATO SIDE	PASSO THREAD
	12 277 2290	Nero Black	-	Con adattatori With adapters
				



UNIVERSALE - UNIVERSAL

Coppia specchi tondi universali pieghevoli con adattatori - Couple of universal rounded folding mirrors with adapters

	CODICE RMS - RMS CODE	COLORE COLOR Nero Black	LATO SIDE -	PASSO THREAD Con adattatori With adapters
	12 277 2250 			

Coppia specchi universali omologati con adattatori - Couple of adjustable homologated rear view mirrors with adapters

	CODICE RMS - RMS CODE	COLORE COLOR Nero Black	LATO SIDE -	PASSO THREAD Con adattatori With adapters
	12 277 2330 			

Coppia specchi universali omologati con adattatori - Couple of adjustable homologated rear view mirrors with adapters

	CODICE RMS - RMS CODE	COLORE COLOR Cromato Chromed	LATO SIDE -	PASSO THREAD Con adattatori With adapters
	12 277 2340 			

ADATTATORI SPECCHI - MIRROR ADAPTERS

	CODICE RMS CODE RMS	BARCODE	Ø D1	T1	D2	T2
	12 185 0060		M8		M10	
	12 185 0070		M8		M10	
	12 185 0080		M8		M8	
	12 185 0090		M8		M10	
	12 185 0100		M8		M10	
	12 185 0110		M8		M8	
	12 185 0120		M10		M10	
	12 185 0130		M10		M8	
	12 185 0140		M10		M8	
	12 185 0150		M10		M10	
	12 185 0160		M10		M8	
	12 185 0170		M10		M8	



RMS

YOUR BEST PARTNER

▶ CAVALLETTI

STANDS

▶ **RMS**
YOUR BEST PARTNER



CAVALLETTI CENTRALI
CENTRAL STANDS

APRILIA

12 161 0010 

50: Sr 93>unificato • Amico
(R.O. AP8232933)



12 161 0030 

50: Sr - Gulliver 94-03
(R.O. AP8232819)



12 161 0040 

50-80-100: Scarabeo 2t
Modifica - *Modified*
(R.O. AP8232927)



12 161 0060 

50: Sr Ditech iniezione 00
(R.O. AP8235090)



12 161 0070 

50: Sonic Gp 98-08
(R.O. AP8232987)



12 161 0100 

50: Scarabeo 2T • Net 2T • Street 2T
Motori Piaggio - *Piaggio Engine*
(R.O. AP8235177)



12 161 0430 

50: Scarabeo Motori Minarelli 2T
Modifica - *Modified*



12 161 0440 

50: Sr Motori Minarelli 2T
Modifica - *Modified*



12 161 0950 

50: Scarabeo Quattro 09 • Scarabeo 4T 02-06 •
Scarabeo 4T Restyling 06-09 • Scarabeo 4T 4V
Net 09-10 • Scarabeo 4T 4V 10-12
100: Scarabeo 4T 01-12
(R.O. 600183)





APRILIA

12 161 0390 

100-125-150: Scarabeo 4T
Motori Piaggio - Piaggio Engine
(R.O. 581835)



12 161 0410 

125-150: Habana
(R.O. 580902-56467R))



12 161 0950 

125: Sonar 4T 09-11
150: Sonar 09
(R.O. 600183)



GILERA

12 161 0110 

50: Runner • Ice • Nrg 96-12
(R.O. 581537)



12 161 0120 

50: Typhoon • Typhoon X 2T 01-11
Typhoon Eu 2 10-12 • Typhoon Eu 3 11
(R.O. 581505)



12 161 0130 

50: Stalker • Runner 97-00
Runner Poggiali 02 • Purejet 02-04 • Sp 02-04
(R.O. 581785)



12 161 0140 

125: Typhoon 95-98 • Runner • Typhoon Xr 98-00
(R.O. 580985)



12 161 0420 

125-180 : Runner 4t • Dna 4t 01-04
(R.O. 582941)





CAVALLETTI CENTRALI
CENTRAL STANDS

HONDA

12 161 0170 

50: Sh • Scoopy 2T 84-89



12 161 0530 

125-150: Chiocciola 4T



12 161 0540 

125-150: Sh 4T
(R.O. 50500-KPR-900)



INNOCENTI

12 161 0960 

125-150-200: Lambretta Li 3° DL serie
(R.O. 19957030)



12 161 0200 

50: Pista 2T 92



ITALJET

KYMCO

12 161 0760 

50: Agility 4T
Ruota 16" - Wheel 16"
(R.O. 00150056)



12 161 0770 

50: Agility 4T
Ruota 12" - Wheel 12"
(R.O. 00165059)



12 161 0150 

125-150: People 4T 03-11
(R.O. 00165700)





KYMCO

12 161 0510 

125-150: Dink 4T
Ruota 10" - *Wheel 10"*



12 161 0520 

125-150: Dink 4T
Ruota 12" - *Wheel 12"*
(R.O. 5050A-KFC8-9000)



12 161 0710 

125: Agility R16 08
Ruota 16" - *Wheel 16"*
(R.O. 00150077)



12 161 0720 

125-150: Agility R16 09
200: Agility R16 10-12
Ruota 16" - *Wheel 16"*
(R.O. 00150139)



12 161 0730 

125: Agility Rs 4T
Ruota 12" - *Wheel 12"*



12 161 0740 

125: Super 8 08-09 4T
(R.O. 00150051)



12 161 0750 

125: Agility Carry 11 • Like 09 • Like Lx 12
200: Like I 09 • Like Lx 12
(R.O. 00150185)



12 161 0820 

125-200: People 4T
(R.O. 0016704)



LML

12 161 0691 

125-150: Scooter 2T Engine 2 Stroke
Zincato - *Galvanized*





CAVALLETTI CENTRALI
CENTRAL STANDS

MALAGUTI

12 161 0180 

50: F10 • Yesterday



12 161 0190 

50: F12 Aria e Lc • F15 • Centro



12 161 0230 

50: Ciak
(R.O. 158048899)



12 161 0450 

50: F12 • F15
Modifica - Modified



12 161 0620 

50: F12 • F15 • Ciak



Con staffa
fissaggio
modifica

MBK

12 161 0180 

50: Sorriso • Evolis 91-93



12 161 0200 

50: Booster 90-94 • Spirit • Road • Ng • Rocket



12 161 0220 

50: Ovetto 97-01





MBK

12 161 0230 

50: Flipper 2T
(R.O. 158048899)



12 161 0240 

50: Stunt 00-02



12 161 0250 

50: Booster Ng • Track • Bump



12 161 0260 

50: Nitro 2T 00-03
100: Booster



12 161 0440 

50: Nitro
Modifica - Modified



12 161 0450 

50: Ovetto 97-01
Modifica - Modified



PEUGEOT

12 161 0620 

50: Flipper
Modifica - Modified



12 161 0570 

50-100: Speedfight • Elyseo • Vivacity •
Xfight • Looxor • Metal X • Jet Force
(R.O. 740232)



12 161 0650 

50: Ludix
Ruota 12"-14" - Wheel 12"-14"
(R.O. 761700)





CAVALLETTI CENTRALI
CENTRAL STANDS

PEUGEOT

12 161 0660



50: Ludix
Ruota 10" - Wheel 10"
(R.O. 761699)



12 161 0390



125-150: Looxor
Motori Piaggio - Piaggio Engine
(R.O. 746916)



PIAGGIO

12 161 0100



50: Zip • Zip Fast Rider 93-94
Zip Rst 96-99 2T
(R.O. 581226)



12 161 0120



50: Typhoon- Typhoon X 12
(R.O. 581805)



12 161 0130



50: Nrg 2T (Tutti - All) 96-12
(R.O. 581785)



12 161 0290



50: Free • Delivery • FL 00-01
Liberty Unificato 2T
(R.O. 271144)



12 161 0300



50: Sfera Rst 2T 91-93 • Quartz 92-96
(R.O. 259209)



12 161 0320



50: Vespa 2T Et2 97-00 • Sfera 95-00
Vespa Lx 2T 10-13 • Navy 08 • S 07-12 •
College 07-12
(R.O. 582155)





PIAGGIO

12 161 0390 

50: Liberty 4T 00-02
125: Liberty 4T 01-02
(R.O. 581835)



12 161 0410 

50-100-125-150: Fly 4T
125: Zip 00-02
150: Et4
(R.O. 601708-56467R-582018)



12 161 0490 

50: Si - Si FL2 2T 91-93
(R.O. 185869)



12 161 0500 

50: Ciao • Px 2T 80-04
(R.O. 252230001)



12 161 0640 

50: Liberty Poste
125: Liberty >05
Modello Poste - Poste model
(Foro Ø 10 - Hole Ø 10 mm)
(R.O. 647563)



12 161 0950 

50: Liberty 4T 04-13 - **125:** Liberty 4T 06-12
150: Liberty 4T 08-13 - **200:** 06-08
(R.O. 600183)



12 161 0930 

50: Vespa Et4 00-05 • Vespa Lx 4T 05-08
Vespa Lx 4T 4V 09-13 • Zip 4T 00-13
100: Zip 4T 06-10
(R.O. 582060)



12 161 0970 

50: Vespa Sprint 4T 4V 14
(R.O. 1C000274)



12 161 0980 

50: Vespa Primavera 4T 4V 14
(R.O. 1C000011)





CAVALLETTI CENTRALI
CENTRAL STANDS

PIAGGIO

12 161 0990 

50: Vespa Primavera 2T 13-14
(R.O. 1C000276)



12 161 1000 

50: Vespa Sprint 2T 14
(R.O. 1C000885)



12 161 1030 

50: Ciao 1° serie



12 161 0140 

125-150: Skipper 2T 94-97
(R.O. 560011)



12 161 0270 

125: Liberty 4t Mod. 98-00
(R.O. 581368)



12 161 0330 

125: Vespa Et4 • Sfera Rst 96-98
(R.O. 562593)



12 161 0700 

125: Vespa Gts 09-13
250: Vespa Gts 05-13
300: Vespa Gts 08-13
(R.O. 665553)



12 161 0940 

125: Vespa Lx 4T 3V le - Touring 12-13
Vespa S 4T 3V le 12-13
150: Vespa Lx 4T 3V le - Touring 12-13
(R.O. 668451)



12 161 1010 

125: Vespa Lx 4T Eu3 Touring 10-11 • Vespa Lx 4T FL 09 • Vespa Lx Eu3 le 09-11 • Vespa Lx Eu3 06-08 • Vespa Lx 05-06 • Vespa Lxv 4T Eu3 06-09 • Vespa Lxv 4T Navy Eu3 07-08 • Vespa Lxv le 4T 10-13 • Vespa S 4T Eu3 07-08 • Vespa S 4T le & College 09-11 • **150:** Vespa Lx 4T FL 09 • Vespa Lx Eu3 le 09-11 • Vespa Lx Eu3 06-08 • Vespa Lx Touring 10-12 • Vespa Lx 05-06 • Vespa S 4T le & College 09-12 • Vespa S 4T 08-09
(R.O. 56467R)





PIAGGIO - VESPA

12 161 0350 

50-90-125: Primavera • Et3
V5A1 - V5A2T - V5B1T - V3T - V9A1 - VMA2
VMB1
Nero - *Black*
Ø 20 mm
Ruota 10" - *Wheel 10"*



12 161 0351 

50-90-125: Primavera • Et3
V5A1 - V5A2T - V5B1T - V3T - V9A1 - VMA2
VMB1
Zincato - *Galvanized*
Ø 20 mm
Ruota 10" - *Wheel 10"*
(R.O. 1353845)



12 161 0352 

50-90-125: Primavera • Et3
V5A1 - V5A2T - V5B1T - V3T - V9A1 - VMA2
VMB1
Cromato - *Chromed*
Ø 20 mm
Ruota 10" - *Wheel 10"*



12 161 0671 

50-125: Pk
V5X1T - V5X2T - V5S1T - VMX1T - VMX5T
VM6XT
Zincato - *Galvanized*
Ø 22 mm
Ruota 10" - *Wheel 10"*
(R.O. 2162476)



12 161 0672 

50-125: Pk
V5X1T - V5X2T - V5S1T - VMX1T - VMX5T
VM6XT
Cromato - *Chromed*
Ø 22 mm
Ruota 10" - *Wheel 10"*



12 161 0830 

50-90:
V5A - V5SA1 - V9A
Zincato - *Galvanized*
Ø 16 mm
Ruota 9" - *Wheel 9"*
(R.O. 070161)



12 161 0360 

125-150-200: Cosa 1 e 2
VSR1T - VNR2T - VLR2T
(Nero - *Black*)
Ø 22 mm
Ruota 10" - *Wheel 10"*
(R.O. 2533615)



12 161 0370 

125-150-200: Px • Pxe Arcobaleno
VNX - VLX - VSX - VNX2 - VLX2 - VSX2
(Nero - *Black*)
Ø 22 mm
Ruota 10" - *Wheel 10"*



12 161 0371 

125-150-200: Px • Pxe Arcobaleno
VNX - VLX - VSX - VNX2 - VLX2 - VSX2
Zincato - *Galvanized*
Ø 22 mm
Ruota 10" - *Wheel 10"*
(R.O. 1761606)





CAVALLETTI CENTRALI
CENTRAL STANDS

PIAGGIO - VESPA

12 161 0372



125-150-200: Px • Pxe Arcobaleno
VNX - VLX - VSX - VNX2 - VLX2 - VSX2
Cromato - *Chromed*
Ø 22 mm
Ruota 10" - *Wheel 10"*



12 161 0380



125-150-200: Px • Pxe Arcobaleno
VNX - VLX - VSX - VNX2 - VLX2 - VSX2
Nero - *Black*
Ø 22 mm
Ruota 10" - *Wheel 10"*



12 161 0790



125: T5
VNX5T
Nero - *Black*
Ø 22 mm
Ruota 10" - *Wheel 10"*
(R.O. 232904)



12 161 0800



125:
VNB1/2/3/4/5
Zincato - *Galvanized*
Ø 20 mm
Ruota 8" - *Wheel 8"*
(R.O.54140)



12 161 0870



125:
VM1/2T-VL1/2T
Zincato - *Galvanized*
Ø 15 mm
Ruota 8" - *Wheel 8"*
(R.O. 017013)



12 161 0880



125:
VNA 1/2T-VNB1/2 - VBA1T - VBB1T
Zincato - *Galvanized*
Ø 16 mm
Ruota 8" - *Wheel 8"*
(R.O. 083814)



12 161 0890



125:
VNA 1T
Zincato - *Galvanized*
Ø 15 mm
Ruota 8" - *Wheel 8"*



12 161 0910



125:
Zincato - *Galvanized*
Ø 15 mm
Ruota 8" - *Wheel 8"*



12 161 1020



125: U
VU1T
Zincato - *Galvanized*
Ruota 8" - *Wheel 8"*





PIAGGIO - VESPA

12 161 0810 

150:
VNB2 - VNB3 - VNB4 - VNB5 - VNB6
Zincato - *Galvanized*
Ø 20 mm
Ruota 10" - *Wheel 10"*
(R.O. 54141)



12 161 0860 

150: Gs
VS4/5
Zincato - *Galvanized*
Ø 15 mm
Ruota 10" - *Wheel 10"*
(R.O. 026452)



12 161 0900 

150:
Zincato - *Galvanized*
Ø 15 mm
Ruota 10" - *Wheel 10"*



12 161 0920 

150:
VGLA-B
Zincato - *Galvanized*
Ø 16 mm
Ruota 10" - *Wheel 10"*



12 161 1051 

150: GL • Sprint • Sprint Veloce
200: Rally
VNL2 - VLB1 - VLA - VSE1
Zincato - *Galvanized*
Ø 20 mm
Ruota 10" - *Wheel 10"*
(R.O. 091047)



12 161 1052 

150: GL • Sprint • Sprint Veloce
200: Rally
VNL2 - VLB1 - VLA - VSE1
Cromato - *Chromed*
Ø 20 mm
Ruota 10" - *Wheel 10"*



SYM

12 161 1040 

50: Symphony 10 • Symphony S 09 • **125:** Symphony St 15 • Symphony Sr 10-14 • Symphony S 13-14 • **150:** Symphony Sr 10-14 • Symphony S 12-14 • **200:** Symphony St 15
(R.O. 50500X4A000)



YAMAHA

12 161 0200 

50: Bump • Bw's



12 161 0220 

50: Neo's • 106 R • Mach
Modifica - *Modified*





CAVALLETTI CENTRALI
CENTRAL STANDS

YAMAHA

12 161 0230



50: Why
(R.O. 158048899)



12 161 0240



50: Slider 00-02



12 161 0250



50: Bw's • Ng • Track • Bump



12 161 0260



50: Aerox
100: Bw's 99-01



12 161 0440



50: Aerox
Modifica - Modified



12 161 0450



50: Neo's
Modifica - Modified



SCOOTER CINESI - CHINESE SCOOTERS

12 161 0620



50: Why
Modifica - Modified



12 161 0840



Scooter Cinesi 50 4T - Chinese Scooters 50 4T



12 161 0850



Scooter Cinesi 125 4T - Chinese Scooters 125 4T





APRILIA

12 163 0020 

50: Sr Www • Rally 98 • Ditech



12 163 0030 

50: Scarabeo



12 163 0300 

50: Sr Ditech 2T Factory Street
Motori Piaggio - Piaggio Engine



Fornito con distanziale e bul-
lone lungo da utilizzare per la
versione con motore Piaggio
With Piaggio engine assembly kit

12 163 0360 

50: Scarabeo Street 2T
Motori Piaggio - Piaggio Engine



12 163 0380 

125-200 : Sportcity 4T 04-06



12 163 0390 

125-200: Scarabeo Light 4T



GILERA

12 163 0050 

50: Typhoon- Storm



12 163 0060 

50: Stalker



12 163 0061 

50: Stalker
Cromato - Chromed





CAVALLETTI LATERALI
SIDE STANDS

GILERA

12 163 0080 

50: Runner



12 163 0310 

50: Runner Sp Kat • FL • Poggiali Purejet



12 163 0420 

50: Nrg Power Dd • Purejet



HONDA

12 163 0280 

125-150: Sh 01-09



12 163 0510 

125-150: Sh 10>



KYMCO

12 163 0590 

50: Like 2T 09 • Like 4T 09
125: Like Lx 12
200: Like I 09 • Like Lx 12
(R.O. 0015059)



LML

12 163 0490 

125-150: Star 2T
Con ritorno automatico - *Automatic return*



12 163 0491 

125-150: Star 2T
Con ritorno automatico - *Automatic return*
Cromato - *Chromed*





MALAGUTI

MBK

12 163 0130 

50: F15



12 163 0550 

50: Dvd



12 163 0150 

50: Nitro • Ng



12 163 0160 

50: Ovetto



12 163 0170 

50: Booster • R • Ng



12 163 0171 

50: Booster • R • Ng
Cromato - Chromed



12 163 0180 

50: Flipper



12 163 0190 

50: Stunt



12 163 0200 

50: Booster • Track





CAVALLETTI LATERALI
SIDE STANDS

MBK

12 163 0320

50: Booster • Spirit Eu 2



12 163 0440

50: Mach



12 163 0450

50: Booster 4T



PEUGEOT

12 163 0220

50: Speedfight • Trekker • Road • Vivacity



12 163 0221

50: Speedfight • Trekker • Road • Vivacity X
Cromato - Chromed



12 163 0460

50: Ludix
Ruota 14" - Wheel 14"



12 163 0500

50: Ludix
Ruota 12" - Wheel 12"



12 163 0610

50: Kisbee



12 163 0640

50: Speedfight 3





PIAGGIO

12 163 0050 

50: Nrg • Ntt • Nrg Extreme



12 163 0051 

50: Nrg • Ntt • Nrg Extreme
Cromato - *Chromed*



12 163 0060 

50: Zip Sp



12 163 0070 

50-125: Liberty
Zampa - *Leg mm 230*



12 163 0250 

50: Zip 2T-4T • Fast Rider • Sfera • Quartz



12 163 0260 

50: Vespa Et2



12 163 0310 

50: Nrg Extreme



12 163 0330 

50-125: Liberty
Zampa - *Leg mm 285*



12 163 0340 

50-125-150: Liberty
Modello Poste - *Poste Model*





CAVALLETTI LATERALI
SIDE STANDS

PIAGGIO

12 163 0350



50: Liberty 2T - 4T 00



12 163 0410



250: X7 IE



12 163 0420



50: Nrg Power DD-Purejet



12 163 0470



50-90-125: Vespa • Primavera
Con ritorno automatico - *Automatic return*



12 163 0480



50-125: Vespa Pk
Con ritorno automatico - *Automatic return*



12 163 0481



50-90-125: Vespa • Primavera
Con ritorno automatico - *Automatic return*
Cromato - *Chromed*



12 163 0490



125-150-200: Vespa Px
Con ritorno automatico - *Automatic return*



12 163 0491



125-150-200: Vespa Px
Con ritorno automatico - *Automatic return*
Cromato - *Chromed*



12 163 0520



125: Vespa Gts
200: Vespa Gtv • Granturismo
250: Vespa Gt 60 • Grs





PIAGGIO

12 163 0521



125: Vespa Gts
200: Vespa Gtv • Granturismo
250: Vespa Gt 60 • Grs
Cromato - *Chromed*



12 163 0580



50: Vespa Lx 2T Touring 10-13 • Vespa Lx 4T 4V
Touring 10-13 • Vespa S 2T 07-12
Vespa S 4T 4V 08-12
125: Vespa Lx 4T Eu 3 Touring 10-11
Vespa Lxv le 4T 10-12
Vespa S 4T 3V le 12-13
Vespa S 4T le 09-11
150: Vespa Lx Touring 10-12
Vespa S 4T le 09-12
Vespa S 4T 08-09
(R.O. 64466R)



12 163 0620



50: Primavera 2T 13-14
125: Primavera Lx 4T 3V le 13
150: Primavera 4T 3V 13



12 163 0630



50: Primavera 2T 13-14
125: Primavera Lx 4T 3V le 13
150: Primavera 4T 3V 13
Cromato - *Chromed*



12 163 0650



50: Vespa Sprint 13-14



12 163 0651



50: Vespa Sprint 13-14
Cromato - *Chromed*



12 163 0660



125-250: Beverly Eu3 Mic 07
125: Beverly Eu3 Sport 07-08 • Beverly Eu3
07-08 • Beverly Rst 05-07 • Beverly Tourer Eu3
07-10 • **250:** Beverly Cruiser 07-09 • Beverly
le Eu3 06-08 • Beverly Sport 06-08 • Beverly
Tourer Eu3 08-09 • Beverly 06-07
300: Beverly Tourer Eu3 09-10



12 163 0661



125-250: Beverly Eu3 Mic 07
125: Beverly Eu3 Sport 07-08 • Beverly Eu3
07-08 • Beverly Rst 05-07 • Beverly Tourer Eu3
07-10 • **250:** Beverly Cruiser 07-09 • Beverly
le Eu3 06-08 • Beverly Sport 06-08 • Beverly
Tourer Eu3 08-09 • Beverly 06-07
300: Beverly Tourer • Eu3 09-10
Cromato - *Chromed*



12 163 0670



125: Beverly Rst 4T 4V le Eu3 10-13
300: Beverly Rst 4T 4V le Eu3 10-14
350: Beverly Rst 4T 4V le Eu3 Sport Touring
11-14





CAVALLETTI LATERALI
SIDE STANDS

PIAGGIO

SUZUKI

12 163 0671

125: Beverly Rst 4T 4V le Eu3 10-13
300: Beverly Rst 4T 4V le Eu3 10-14
350: Beverly Rst 4T 4V le Eu3 Sport Touring 11-14
Cromato - *Chromed*

12 163 0530

125-150: Sixteen



YAMAHA

12 163 0150

50: Aerox

12 163 0160

50: Neo's

12 163 0170

50: Bws



12 163 0171

50: Bws
Cromato - *Chromed*

12 163 0180

50: Why

12 163 0190

50: Slider





YAMAHA

12 163 0200 

50: Bump • Bws



12 163 0320 

50: Bws Original Eu 2



12 163 0440 

50: Jog R



12 163 0450 

50: Giggle 4T



12 163 0540 

125-150: Xenter



12 163 0600 

50: Neo's 4T



SCOOTER CINESI - CHINESE SCOOTERS

12 163 0560 

Scooter Cinesi 50 4T - Chinese Scooters 50 4T



12 163 0570 

Scooter Cinesi 125 4T - Chinese Scooters 125 4T





CAVALLETTI LATERALI

SIDE STANDS

MODELLO MODEL	CC	ANNO YEAR	CODICE CODE
APRILIA			
Scarabeo	50	94-97	12 163 0030
Scarabeo Street 2T dal 05> (M. Piaggio)	50		12 163 0360
Sr www - Rally 98 - Ditech	50		12 163 0020
Sr-Ditech-2T-Factory-Street (Mot. Piaggio e Minar.)	50	00>	12 163 0300
Sport City 4T	250	06-07	12 163 0390
Sport City 4T	300	08	12 163 0390
Scarabeo 4T Light	125-200	06-07	12 163 0390
Sport City 4T	125-200	04-06	12 163 0380
GILERA			
Runner	50		12 163 0080
Runner Sp	50	05>	12 163 0420
Runner-Purejet	50	05>	12 163 0420
Runner-Sp-Kat-FL Poggiali-Purejet	50	01>	12 163 0310
Stalker	50		12 163 0060
Stalker (Cromato)	50		12 163 0061
Typhoon - Storm	50		12 163 0050
Runner St	200	08-09	12 163 0420
HONDA			
Sh	125-150	01-09	12 163 0280
Sh	125-150	10>	12 163 0510
KYMCO			
Like 2T - 4T	50	09	12 163 0590
Like Lx	125	12	12 163 0590
Like I	200	09	12 163 0590
Like Lx	200	12	12 163 0590
LML			
Star 2T Ritorno automatico	125-150		12 163 0490
Star 2T Ritorno autom. (Cromato)	125-150		12 163 0491
MALAGUTI			
Dvd	50		12 163 0550
F15	50		12 163 0130
MBK			
Booster - R - Ng	50		12 163 0170
Booster - R - Ng (Cromato)	50		12 163 0171
Booster - Track	50		12 163 0200
Booster Spirit Eu2	50	90-04	12 163 0320
Booster X 4T	50		12 163 0450
Flipper	50		12 163 0180
Mach G	50	02-04	12 163 0440
Nitro - Ng	50	98>	12 163 0150
Ovetto	50		12 163 0160
Stunt	50		12 163 0190
PEUGEOT			
Kisbee	50		12 163 0610
Ludix ruote 12"	50		12 163 0500
Ludix-14"	50	04	12 163 0460
Speedfight - Trekker - Road - Vivacity	50		12 163 0220
Speedfight 3	50		12 163 0640
Speedfight-Trekker-Road-Vivacity (Crom.)	50		12 163 0221
PIAGGIO			
Liberty - (Zampa lunghezza 230 mm)	50-125		12 163 0070
Liberty - (Zampa lunghezza 285 mm)	50-125		12 163 0330
Liberty 2T/4T dal 2000>	50		12 163 0350

MODELLO MODEL	CC	ANNO YEAR	CODICE CODE
Nrg Extreme Lc - Mc3 - Purejet-Fly	50-125-150	00>	12 163 0310
Nrg Power DD-Purejet	50	05>	12 163 0420
Nrg-Ntt-Nrg Extreme	50		12 163 0050
Vespa Et2	50		12 163 0260
Vespa Et4-Lx	50-125-150		12 163 0260
Vespa Lx 2T Touring	50	10-13	12 163 0580
Vespa Lx 4T 4V Touring	50	10-13	12 163 0580
Vespa Pk-Pks Ritorno automatico	50-125		12 163 0480
Vespa Primavera 2T	50	13-14	12 163 0620
Vespa Primavera 2T	50	13-14	12 163 0630
Vespa Primavera-Et3 Ritorno automatico	50-90-125		12 163 0470
Vespa S 2T	50	07-12	12 163 0580
Vespa S 4T 4V	50	08-12	12 163 0580
Zip 2-4T - Fast Rider - Sfera - Quartz	50		12 163 0250
Zip Sp	50	06-09	12 163 0060
Liberty Poste	125-150-200		12 163 0340
Skipper 4T	125-150		12 163 0050
Vespa Lx 4T Eu3 Touring	125	10-11	12 163 0580
Vespa Lxv ie 4T	125	10-12	12 163 0580
Vespa Primavera Lx 4T 3V ie	125	13	12 163 0620
Vespa Primavera Lx 4T 3V ie	125	13	12 163 0630
Vespa Px-Pxe Ritorno automatico (Cromato)	125-150		12 163 0491
Vespa Px-Pxe Ritorno automatico	125-150		12 163 0490
Vespa S 4T 3V ie	125	12-13	12 163 0580
Vespa S 4T ie	125	09-11	12 163 0580
Vespa Lx Touring	150	10-12	12 163 0580
Vespa Primavera 4T 3V	150	13	12 163 0620
Vespa Primavera 4T 3V	150	13	12 163 0630
Vespa S 4T	150	08-09	12 163 0580
Vespa S 4T ie	150	09-12	12 163 0580
Vespa Px-Pe	200		12 163 0490
Vespa Gtv (Cromato)	200-300		12 163 0521
Vespa Gtv	200-300		12 163 0520
X7 ie	250		12 163 0410
SUZUKI			
Sixteen	125-150		12 163 0530
YAMAHA			
Aerox	50		12 163 0150
Aerox (Cromato)	50		12 163 0151
Bump - Bw's	50	98-00	12 163 0200
Bw's	50		12 163 0170
Bw's (Cromato)	50		12 163 0171
Bw's Original Eu2	50	90-04	12 163 0320
Giggle 4T	50	08>	12 163 0450
Jog R	50		12 163 0440
Neo's 2T	50		12 163 0160
Neo's 4T	50		12 163 0600
Slider	50		12 163 0190
Why	50		12 163 0180
Xenter	125-150		12 163 0540



12 161 9010 

KIT PERNO MOLLE CAVALLETTO CENTRALE
CENTRAL STAND SPRING AND PIVOT KIT
APRILIA: Scarabeo 50-80-100 • Sr 50 94-97
Rally Gulliver • Sonic Gp • Sr 125-150
BETA 50: Quadra • Ark



12 161 9030 

KIT PERNO MOLLE CAVALLETTO CENTRALE
CENTRAL STAND SPRING AND PIVOT KIT
APRILIA 125-150: Scarabeo • Leonardo



12 161 9050 

KIT PERNO MOLLE CAVALLETTO CENTRALE
CENTRAL STAND SPRING AND PIVOT KIT
PIAGGIO 125: Liberty 98/00
Et4 96-99 • Sfera Rst 95-97



12 161 9060 

KIT PERNO MOLLE CAVALLETTO CENTRALE
CENTRAL STAND SPRING AND PIVOT KIT
GILERA 125-180: Runner • Vx • Vxr
PIAGGIO 50-125-150: Liberty 4T 00>
Et4 4T 99> • Skipper • Hexagon
125: Zip 4T



12 161 9070 

KIT MOLLE CAVALLETTO CENTRALE
CENTRAL STAND SPRING SET
KYMCO 125-150: People



12 161 9080 

KIT PERNO MOLLE CAVALLETTO CENTRALE
CENTRAL STAND SPRING AND PIVOT KIT
ITALJET 50: Pista
YAMAHA 50: Bump • Slider • Spy • Bw's
Original • Ng Bump
MBK 50: Booster 90-94 • Spirit Road • Ng
• Rocket • Booster Ng 00 • Stunt • Track



12 161 9150 

KIT MOLLE CAVALLETTO CENTRALE
CENTRAL STAND SPRING SET
HONDA 125-150: Sh



12 161 9160 

KIT MOLLE CAVALLETTO CENTRALE
CENTRAL STAND SPRING SET
HONDA 125-150: Chiocciola



12 161 9170 

KIT PERNO MOLLE CAVALLETTO CENTRALE
CENTRAL STAND SPRING AND PIVOT KIT
PIAGGIO 50: Free • Liberty • Zip • Sfera
• Quartz • Et2
GILERA 50: Typhoon • Stalker • Runner



12 161 9180 

KIT PERNO MOLLE CAVALLETTO CENTRALE
CENTRAL STAND SPRING AND PIVOT KIT
GILERA 50: Dna



12 161 9190 

KIT PERNO MOLLE CAVALLETTO CENTRALE
CENTRAL STAND SPRING AND PIVOT KIT
Versione - Model 2005

GILERA 50: Easy Moving • Runner • Stalker-
Storm • Typhoon
PIAGGIO 50: Free FL • Nrg • Nrg Rst • Liberty
Ntt • Sfera Rst • Sfera Maquillage 2 VespaEt2
Iniezione • ZIP Tutti • **50-80:** Quartz-Sfera



12 161 9200 

KIT PERNO MOLLE CAVALLETTO CENTRALE
CENTRAL STAND SPRING AND PIVOT KIT
KIMCO 125-150: Dink





CAVALLETTI ACCESSORI VARI

SIDE STAND ACCESSORIES

12 189 0010



MOLLA CAVALLETTO - STAND SPRING

MBK 50: Booster



12 189 0020



MOLLA CAVALLETTO - STAND SPRING

PIAGGIO GILERA 50: Scooter • Sfera • Liberty
125: Vespa Et4 95-00



12 189 0030



MOLLA CAVALLETTO - STAND SPRING

PIAGGIO 50-90-125: Vespa Primavera Et3
(R.O. 277269)



12 189 0040



MOLLA CAVALLETTO - STAND SPRING

PIAGGIO 50-125: Vespa Pk • Pk XL • Rush-FL
(R.O. 2216255)



12 189 0050



MOLLA CAVALLETTO - STAND SPRING

PIAGGIO 125-150-200: Vespa Px • Pe
(R.O. 176169)



12 189 0060



KIT MOLLE CAVALLETTO CENTRALE
CENTRAL STAND SPRING SET

APRILIA 50: Sr



12 189 0080



MOLLA CAVALLETTO - STAND SPRING

PIAGGIO 125-150-200: Cosa VLR1T-VLR-VSX2
(R.O. 257430)



12 189 0090



MOLLA CAVALLETTO - STAND SPRING

PIAGGIO 125-150: Vespa T5-Px 11 • VNX5T
(R.O. 176444)



12 189 0100



MOLLE CAVALLETTO - STAND SPRINGS

PIAGGIO 50: Ciao
(R.O. 139136-7)



12 189 0110



MOLLE CAVALLETTO - STAND SPRINGS

PIAGGIO 50: Si
(R.O. 164166-7)





12 183 0050 

GOMMINO CAVALLETTO CENTRALE
CENTRAL STAND RUBBER

KYMCO 50: Agility 4T R12 07-08 • 4T R16 09 • Rs 09 • Rs Naked 2T 10 • Dink 4T 07 • Like 2-4T 09 • People S 4T 06-08 • Sento 08 • Super 8 07
125: Dink Eu 3 06-07 • Downtown 09 • People S 05 • People S Dd Eu 3 07-08 • **150:** Agility R16 08
200: Agility I R16 10 • Dink Eu 3 I 06-07 • People S 05 • People S I 07 • Like I 09 • **250:** People S 06 • S I 07 • X Citing 05 • I 06-07 • **300:** Downtown I 09 • Abs 10 • People S I 08 • X Citing I 08 • I R 08 • I R 09 • **500:** X Citing R 09 • X Citing 05 • I 06-08 • R 07-08



12 183 0140 

GOMMINI CAVALLETTO - RUBBER PADS
PIAGGIO 50-90-125: Vespa Et3 • Primavera Confez. Industriale 10 Cp. - *Packaging 10 pcs* (R.O. 135387/8)



12 183 0150 

GOMMINI CAVALLETTO - RUBBER PADS
PIAGGIO 50-125: Vespa Pk • Pk XL • Rush • N • FL
125-150-200: Px • Pe (R.O. 176166)



12 183 0159 

GOMMINI CAVALLETTO - RUBBER PADS
PIAGGIO 50-125: Vespa Pk • Pk XL • Rush • N • FL
125-150-200: Px • Pe Confez. Industriale 100 Cp. - *Packaging 100 pcs* (R.O. 176166)



12 183 0540 

GOMMINI CAVALLETTO - RUBBER PADS
PIAGGIO 150: Vespa Sprint • GL Sprint Veloce • Super
180-200: Rally (R.O. 54146-7)



12 161 9130 

COPPIA PIASTRINE CAVALLETTO CENTRALE
CENTRAL STAND BRACKETS
PIAGGIO 50-90-125: Vespa Et3 • Primavera (R.O. 135390/I)



12 161 9140 

COPPIA PIASTRINE CAVALLETTO CENTRALE
CENTRAL STAND BRACKETS
PIAGGIO 125-150-200: Vespa Px • Pe (R.O. 176167/68)



12 161 9210 

COPPIA PIASTRINE CAVALLETTO CENTRALE
CENTRAL STAND BRACKETS
PIAGGIO 150: Vespa GL Sprint (R.O. 59188/9)



12 161 9220 

COPPIA PIASTRINE CAVALLETTO CENTRALE
CENTRAL STAND BRACKETS
PIAGGIO 50: Vespa 1° Serie



12 161 9230 

COPPIA PIASTRINE CAVALLETTO CENTRALE
CENTRAL STAND BRACKETS
PIAGGIO 150: Vespa Gs



12 161 9250 

COPPIA PIASTRINE CAVALLETTO CENTRALE
CENTRAL STAND BRACKETS
PIAGGIO 50-125: Vespa Pk XL • VSX1T V5X2T • V5S1T • VMX1T • VMX5T • VMX6T (R.O. 233120-216252)





CAVALLETTI ACCESSORI VARI

SIDE STAND ACCESSORIES

14 270 0360



SUPPORTO CAVALLETTO - *STAND SUPPORTS*
APRILIA - YAMAHA

mm 6



14 270 0370



SUPPORTO CAVALLETTO - *STAND SUPPORTS*
DUCATI - HONDA - SUZUKI

mm 8



14 270 0380



SUPPORTO CAVALLETTO - *STAND SUPPORTS*
KAWASAKI

mm 10



14 270 0361



SUPPORTO CAVALLETTO - *STAND SUPPORTS*
APRILIA - YAMAHA

mm 6



14 270 0371



SUPPORTO CAVALLETTO - *STAND SUPPORTS*
DUCATI - HONDA - SUZUKI

mm 8



14 270 0381



SUPPORTO CAVALLETTO - *STAND SUPPORTS*
KAWASAKI

mm 10



▶ AMMORTIZZATORI

SHOCK ABSORBERS





AMMORTIZZATORI SCOOTER 50 CC

50 CC SCOOTER SHOCK ABSORBERS

MARCA MODELLO - TRADEMARK MODEL	CODICE - CODE	MARCA MODELLO - TRADEMARK MODEL	CODICE - CODE
APRILIA: Scarabeo 93-97 • Sr - Sr Lc 93-96 (R.O. AP8203631) BENELLI: 491 98-01 HONDA: Sky 97-04	20 455 0032 	APRILIA: Scarabeo 98-05 (R.O. AP8203946)	20 455 0042
APRILIA: Rally - Rally Lc 95-03 (R.O. AP8203750)	20 455 0052 	GILERA: Easy Moving 95-96 • Storm 94-95 (R.O. 2729604) HONDA: Gp Dio • Vision Met-in • Vision 1° serie PIAGGIO: Free 92-94 • Ntt 95-96 • Zip 00-04 (R.O. 2729604)	20 455 0062
PIAGGIO: Nrg 96-04 • Typhoon 01-11 • Vespa Et2 97-05 • Vespa Et4 00-05 • Vespa Lx 05-13 (R.O. 667967)	20 455 0082 	SUZUKI: Aj ZZ Sepia S 95-97	20 455 0092
MALAGUTI: F10 92-08 • Yesterday 97-00 (R.O. 01004603)	20 455 0122 	MALAGUTI: Centro - SL 93-00 (R.O. 01003100)	20 455 0132
MALAGUTI: F12 Aria - Lc - Phantom 94-06 (R.O. 01003408)	20 455 0142 	MBK: Booster • Booster Spirit 96-03 YAMAHA: Bw's 97-03 (R.O. 4VVF22100000)	20 455 0162

AMMORTIZZATORI SCOOTER 50 CC

50 CC SCOOTER SHOCK ABSORBERS



MARCA MODELLO - TRADEMARK MODEL

CODICE - CODE

MBK: Ynr Ovetto 97-04
YAMAHA: Neo's 97-06
(R.O. 5KKF22100033)

20 455 0182



PIAGGIO: Sfera Rst 95-97
(R.O. 564110)

20 455 0222

MARCA MODELLO - TRADEMARK MODEL

CODICE - CODE

PEUGEOT: Buxy 94-97 • Sc Metropolis 91
Speedake 94-97 • St Rapido 85-93

20 455 0192



PIAGGIO: Liberty Ptt Eu 2 04-05
(R.O. 564949)

20 455 0352



APRILIA: Sport City One 2T/4T 08-11
Sr Motard 12-13
(R.O. 856481)

20 455 0452



APRILIA: Sr R 04-14 • Sr Street 03-12
(R.O. AP8223036)

20 455 0472



KYMCO 50: Agility 4T R16 08-12
(R.O. 00152232)
Di primo equipaggiamento - *OEM Quality*

20 455 0582



KYMCO 50: Agility 4T Carry 11
• Agility R12 05 • Agility 4T R12 07-08
• Agility Rs 09 (R.O. 00166107)
Di primo equipaggiamento - *OEM Quality*

20 455 0592



APRILIA: Scarabeo 2T 10-12 • Scarabeo 4T 4V 09-14 • Scarabeo 4T 02-06 • Scarabeo 4T Restyling 06-09 • Scarabeo Quattro 09
(R.O. 666265)

20 455 0642



APRILIA 50: Scarabeo 2T Net 09 • Scarabeo Street 2T Restyling 06-09 • Scarabeo Street 05-06
(R.O. AP8223120)

20 455 0862





AMMORTIZZATORI SCOOTER 50 CC

50 CC SCOOTER SHOCK ABSORBERS

MARCA MODELLO - TRADEMARK MODEL	CODICE - CODE	MARCA MODELLO - TRADEMARK MODEL	CODICE - CODE
PIAGGIO: Sfera Rst 95-97 • Vespa Et2 Iniezione 97-00 • Vespa Et2 97-05 • Vespa Et4 00-05 • Zip Sp 01-13 (R.O. 598922)	20 458 4212 	YAMAHA 50: Yq Aerox 04-12 Ns N Aerox Naked 13-14 (R.O. 5BSF2210A000-5BRF22105100)	20 455 0902



PIAGGIO: Liberty 4T Rst 04 • Liberty 4T Sport 06-08 • Liberty 4T 00-08 • Liberty Moc 4T & Elle 09-13 (R.O. 648088)	20 455 0882 	PIAGGIO: Vespa Lx 2T - 4T 05-13 (R.O. 646959)	20 458 4372
---	------------------------	--	------------------------



AMMORTIZZATORI SCOOTER 50 CC

50 CC SCOOTER SHOCK ABSORBERS



CODICE RMS RMS CODE	MODELLO MODEL	ANNI YEARS	RIF ORIGINALE OEM NUMBER	ANT POST FRONT REAR	L (mm)	ATTACCO SUPERIORE UPPER FASTENING POINT			ATTACCO INFERIORE LOWER FASTENING POINT		
						Tipo Type	D (mm)	W (mm)	Tipo Type	D (mm)	W (mm)
APRILIA											
20 455 0032	Scarabeo	93-97	AP8203631	Post-Rear	290	A	10,1	20	B	M8x1.25	20
20 455 0032	Sr	93-96	AP8203631	Post-Rear	290	A	10,1	20	B	M8x1.25	20
20 455 0032	Sr Liquid Cooled	94-96	AP8203631	Post-Rear	290	A	10,1	20	B	M8x1.25	20
20 455 0042	Scarabeo	98-05	AP8203946	Post-Rear	290	A	10,2	20	B	M8x1.25	20
20 455 0052	Rally	95-03	AP8203750	Post-Rear	290	A	10,1	20	B	M8x1.25	20
20 455 0052	Rally Lc	96-99	AP8203750	Post-Rear	290	A	10,1	20	B	M8x1.25	20
20 455 0452	Sport City One 2t	08-11	856441	Post-Rear	340	A	10,2	28	B	10,1	33
20 455 0452	Sport City One 4t	08-10	856441	Post-Rear	340	A	10,2	28	B	10,1	33
20 455 0452	Sr Motard	12	856441	Post-Rear	340	A	10,2	28	B	10,1	33
20 455 0472	Sr R Factory ie E Carbur.	10-14	AP8223036	Post-Rear	300	A	10,15	21	B	10,1	36
20 455 0472	Sr R R Factory	04-09	AP8223036	Post-Rear	300	A	10,15	21	B	10,1	36
20 455 0472	Sr Iniezione - Carburatore	14	AP8223036	Post-Rear	300	A	10,15	21	B	10,1	36
20 455 0472	Sr Street	03-12	AP8223036	Post-Rear	300	A	10,15	21	B	10,1	36
20 455 0642	Scarabeo 2t	10-12	666265	Post-Rear	345	A	10,1	21,6	B	10,1	33
20 455 0642	Scarabeo 4t	02-06	666265	Post-Rear	345	A	10,1	21,6	B	10,1	33
20 455 0642	Scarabeo 4t 4v	09-14	666265	Post-Rear	345	A	10,1	21,6	B	10,1	33
20 455 0642	Scarabeo 4t Restyling	06-09	666265	Post-Rear	345	A	10,1	21,6	B	10,1	33
20 455 0642	Scarabeo Quattro	09	666265	Post-Rear	345	A	10,1	21,6	B	10,1	33
20 455 0862	Scarabeo 2T Net	09	AP8223120	Post-Rear	310	A	10,2	20	B	10,5	33,5
20 455 0862	Scarabeo Street 2T	06-09	AP8223120	Post-Rear	310	A	10,2	20	B	10,5	33,5
20 455 0862	Scarabeo Street	05-06	AP8223120	Post-Rear	310	A	10,2	20	B	10,5	33,5
BENELLI											
20 455 0032	491 Sport	98-99		Post-Rear	290	A	10,1	20	B	M8x1.25	20
20 455 0032	491 St	-		Post-Rear	290	A	10,1	20	B	M8x1.25	20
20 455 0032	491 St Morini	98-01		Post-Rear	290	A	10,1	20	B	M8x1.25	20
GILERA											
20 455 0062	Easy Moving	95-96	2729604	Post-Rear	340	C	M8x1.25		B	10,1	33
20 455 0062	Storm	94-95	2729604	Post-Rear	340	C	M8x1.25		B	10,1	33
HONDA											
20 455 0032	Sky	97-04		Post-Rear	290	A	10,1	20	B	M8x1.25	20
20 455 0062	Gp Dio	-		Post-Rear	340	C	M8x1.25		B	10,1	33
20 455 0062	Vision Met-In	-		Post-Rear	340	C	M8x1.25		B	10,1	33
20 455 0062	Vision Prima Serie	-		Post-Rear	340	C	M8x1.25		B	10,1	33
KYMCO											
20 455 0582	Agility 4T R16	08-12	00152232	Post-Rear	308	A	10,1	20	B	M8x1.25	20
20 455 0592	Agility 4T Carry	11	00166107	Post-Rear	338	A	10,1	20	B	M8x1.25	20
20 455 0592	Agility R12	05	00166107	Post-Rear	338	A	10,1	20	B	M8x1.25	20
20 455 0592	Agility 4T R12	07-08	00166107	Post-Rear	338	A	10,1	20	B	M8x1.25	20
20 455 0592	Agility Rs	09	00166107	Post-Rear	338	A	10,1	20	B	M8x1.25	20
MALAGUTI											
20 455 0122	F10 Ac	08	01004603	Post-Rear	245	A	10,1	20	B	M8x1.25	20
20 455 0122	F10 Ac Eco	09-10	01004603	Post-Rear	245	A	10,1	20	B	M8x1.25	20
20 455 0122	F10 Jet Line	92-98	01004603	Post-Rear	245	A	10,1	20	B	M8x1.25	20
20 455 0122	F10 Kat	99-00	01004603	Post-Rear	245	A	10,1	20	B	M8x1.25	20
20 455 0122	F10 Rst Eu1	01-02	01004603	Post-Rear	245	A	10,1	20	B	M8x1.25	20
20 455 0122	F10 Rst Eu2	02-06	01004603	Post-Rear	245	A	10,1	20	B	M8x1.25	20



AMMORTIZZATORI SCOOTER 50 CC

50 CC SCOOTER SHOCK ABSORBERS

CODICE RMS RMS CODE	MODELLO MODEL	ANNI YEARS	RIF ORIGINALE OEM NUMBER	ANT POST FRONT REAR	L (mm)	ATTACCO SUPERIORE UPPER FASTENING POINT			ATTACCO INFERIORE LOWER FASTENING POINT		
						Tipo Type	D (mm)	W (mm)	Tipo Type	D (mm)	W (mm)
20 455 0122	F10 Rst Eu2-2.3	03-04	01004603	Post-Rear	245	A	10,1	20	B	M8 x 1.25	20
20 455 0122	Yesterday - Yesterday Eu	97-00	01004603	Post-Rear	245	A	10,1	20	B	M8 x 1.25	20
20 455 0132	Centro Base	93-94	01003100	Post-Rear	225	A	10,1	20	B	M8 x 1.25	20
20 455 0132	Centro SL	94-98	01003100	Post-Rear	225	A	10,1	20	B	M8 x 1.25	20
20 455 0132	Centro SI Kat	99-00	01003100	Post-Rear	225	A	10,1	20	B	M8 x 1.25	20
20 455 0142	F12 Aria Rst Eu2	06	01003408	Post-Rear	255	A	10,2	20	B	M8 x 1.25	20
20 455 0142	F12 Lc Rst Eu2	02	01003408	Post-Rear	255	A	10,2	20	B	M8 x 1.25	20
20 455 0142	F12 Phantom	94-98	01003408	Post-Rear	255	A	10,2	20	B	M8 x 1.25	20
20 455 0142	F12 Phantom Eu1	99-00	01003408	Post-Rear	255	A	10,2	20	B	M8 x 1.25	20
20 455 0142	F12 Phantom Lc	94-98	01003408	Post-Rear	255	A	10,2	20	B	M8 x 1.25	20
20 455 0142	F12 Phantom Lc Eu1	01-02	01003408	Post-Rear	255	A	10,2	20	B	M8 x 1.25	20
20 455 0142	F12 Phantom Lc Rst Eu1	01-02	01003408	Post-Rear	255	A	10,2	20	B	M8 x 1.25	20
20 455 0142	F12 Phantom Lc Rst Eu2	02	01003408	Post-Rear	255	A	10,2	20	B	M8 x 1.25	20
20 455 0142	F12 Phan. Lc Rst Eu2-2.3	03-04	01003408	Post-Rear	255	A	10,2	20	B	M8 x 1.25	20
20 455 0142	F12 Phan. Lc Twin Disks	98-98	01003408	Post-Rear	255	A	10,2	20	B	M8 x 1.25	20
20 455 0142	F12 Phantom Rst Eu1	01-02	01003408	Post-Rear	255	A	10,2	20	B	M8 x 1.25	20
20 455 0142	F12 Phantom Rst Eu2	02	01003408	Post-Rear	255	A	10,2	20	B	M8 x 1.25	20
20 455 0142	F12 Phantom Rst Eu2-2.3	03-04	01003408	Post-Rear	255	A	10,2	20	B	M8 x 1.25	20
MBK											
20 455 0162	Booster	01-02	4VVF22100000	Post-Rear	245	A	10,1	20	B	M8 x 1.25	20
20 455 0162	Booster Spirit	96-98	4VVF22100000	Post-Rear	245	A	10,1	20	B	M8 x 1.25	20
20 455 0162	Booster Spirit (Ita)	99-00	4VVF22100000	Post-Rear	245	A	10,1	20	B	M8 x 1.25	20
20 455 0162	Booster Spirit Eu2	02-03	4VVF22100000	Post-Rear	245	A	10,1	20	B	M8 x 1.25	20
20 455 0182	Yn R Ovetto (Che-Ita)	97-04	5KKF22100033	Post-Rear	280	A	10,1	20	B	M8 x 1.25	20
PEUGEOT											
20 455 0192	Buxy	94-97		Post-Rear	280	A	10,2	20	B	M8 x 1.25	20
20 455 0192	Sc Metropolis Lm-Sxlm	91-91		Post-Rear	280	A	10,2	20	B	M8 x 1.25	20
20 455 0192	Speedake	94-97		Post-Rear	280	A	10,2	20	B	M8 x 1.25	20
20 455 0192	St Rapido	85-93		Post-Rear	280	A	10,2	20	B	M8 x 1.25	20
PIAGGIO											
20 455 0062	Free	92-94	2729604	Post-Rear	340	C	M8 x 1.25	15	B	10,1	33
20 455 0062	Ntt	95-96	2729604	Post-Rear	340	C	M8 x 1.25	15	B	10,1	33
20 455 0062	Zip	00-04	2729604	Post-Rear	340	C	M8 x 1.25	15	B	10,1	33
20 455 0082	Nrg Extreme	99-00	667967	Post-Rear	330	C	M8 x 1.0	15	B	10,1	33
20 455 0082	Nrg Mc3	01-04	667967	Post-Rear	330	C	M8 x 1.0	15	B	10,1	33
20 455 0082	Nrg Purejet	02-04	667967	Post-Rear	330	C	M8 x 1.0	15	B	10,1	33
20 455 0082	Nrg Rst Mc2	96-98	667967	Post-Rear	330	C	M8 x 1.0	15	B	10,1	33
20 455 0082	Typhoon	01-11	667967	Post-Rear	330	C	M8 x 1.0	15	B	10,1	33
20 455 0082	Vespa Et2	97-05	667967	Post-Rear	330	C	M8 x 1.0	15	B	10,1	33
20 455 0082	Vespa Et2 Iniezione	97-00	667967	Post-Rear	330	C	M8 x 1.0	15	B	10,1	33
20 455 0082	Vespa Et4	00-05	667967	Post-Rear	330	C	M8 x 1.0	15	B	10,1	33
20 455 0082	Vespa Lx 2t	05-13	667967	Post-Rear	330	C	M8 x 1.0	15	B	10,1	33
20 455 0082	Vespa Lx 2t Fl	09-10	667967	Post-Rear	330	C	M8 x 1.0	15	B	10,1	33
20 455 0082	Vespa Lx 2t Touring	10-13	667967	Post-Rear	330	C	M8 x 1.0	15	B	10,1	33
20 455 0082	Vespa Lx 4t	05-08	667967	Post-Rear	330	C	M8 x 1.0	15	B	10,1	33
20 455 0082	Vespa Lx 4t-4v	09-13	667967	Post-Rear	330	C	M8 x 1.0	15	B	10,1	33
20 455 0082	Vespa Lx 4t-4v Touring	10-13	667967	Post-Rear	330	C	M8 x 1.0	15	B	10,1	33

AMMORTIZZATORI SCOOTER 50 CC

50 CC SCOOTER SHOCK ABSORBERS



CODICE RMS RMS CODE	MODELLO MODEL	ANNI YEARS	RIF ORIGINALE OEM NUMBER	ANT POST FRONT REAR	L (mm)	ATTACCO SUPERIORE UPPER FASTENING POINT			ATTACCO INFERIORE LOWER FASTENING POINT		
						Tipo Type	D (mm)	W (mm)	Tipo Type	D (mm)	W (mm)
20 455 0082	Vespa Lxv 2t	06-08	667967	Post-Rear	330	C	M8 x 1.0	15	B	10,1	33
20 455 0082	Vespa Lxv 2t Navy	08	667967	Post-Rear	330	C	M8 x 1.0	15	B	10,1	33
20 458 4212	Sfera Rst	95-97	598922	Ant-Front	264	C	M8 x 125	14	D	M8	35
20 458 4212	Vespa Et2 iniezione	97-00	598922	Ant-Front	264	C	M8 x 125	14	D	M8	35
20 458 4212	Vespa Et2	97-05	598922	Ant-Front	264	C	M8 x 125	14	D	M8	35
20 458 4212	Vespa Et4	00-05	598922	Ant-Front	264	C	M8 x 125	14	D	M8	35
20 458 4212	Zip Sp	01-13	598922	Ant-Front	264	C	M8 x 125	14	D	M8	35
20 455 0222	Sfera Rst	95-97	564110	Post-Rear	325	C	M8 x 1.0	25	B	10,1	33
20 455 0352	Liberty Ptt Eu2	04-05	564949	Post-Rear	329	C	M8 x 1.0	20,5	B	10,1	37
20 455 0882	Liberty 4T Rst	04	648088	Post-Rear	348	C	M8 x 1.0	22	B	10,1	33
20 455 0882	Liberty 4T Sport	06-08	648088	Post-Rear	348	C	M8 x 1.0	22	B	10,1	33
20 455 0882	Liberty 4T	00-08	648088	Post-Rear	348	C	M8 x 1.0	22	B	10,1	33
20 455 0882	Liberty Moc 4T & Elle	09-13	648088	Post-Rear	348	C	M8 x 1.0	22	B	10,1	33
20 458 4372	Vespa Lx 2t	05-13	646959	Ant-Front	266	C	M10x125	15	D	M8x125	35
20 458 4372	Vespa Lx 2t Touring	10-13	646959	Ant-Front	266	C	M10x125	15	D	M8x125	35
20 458 4372	Vespa Lx 4t	05-08	646959	Ant-Front	266	C	M10x125	15	D	M8x125	35
20 458 4372	Vespa Lx 4t-4v	09-13	646959	Ant-Front	266	C	M10x125	15	D	M8x125	35
20 458 4372	Vespa Lx 4t-4v Touring	10-13	646959	Ant-Front	266	C	M10x125	15	D	M8x125	35
SUZUKI											
20 455 0092	Aj Zz Sepia S	95-97		Post-Rear	265	A	10,1	20	B	M8x125	20
YAMAHA											
20 455 0162	Bw's Original	97-02	4VVF22100000	Post-Rear	245	A	10,1	20	B	M8x125	20
20 455 0162	Bw's Original Eu2	03	4VVF22100000	Post-Rear	245	A	10,1	20	B	M8x125	20
20 455 0162	Cw Bw's Original Eu2	02	4VVF22100000	Post-Rear	245	A	10,1	20	B	M8x125	20
20 455 0182	Neo's	97-06	5KKF22100033	Post-Rear	280	A	10,1	20	B	M8x125	20
20 455 0902	Yq Aerox	04-14	5BSF2210A000 5BRF22105100	Post-Rear	273	A	10,1	20	B	M8x1,25	20
20 455 0902	Ns N Aerox Naked	13-14	5BSF2210A000 5BRF22105100	Post-Rear	273	A	10,1	20	B	M8x1,25	20

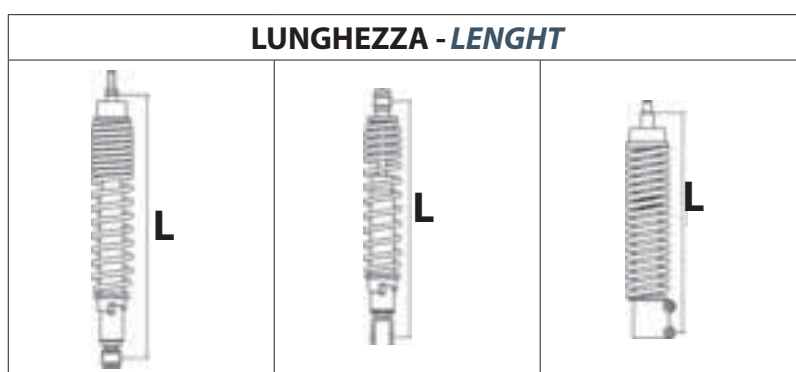
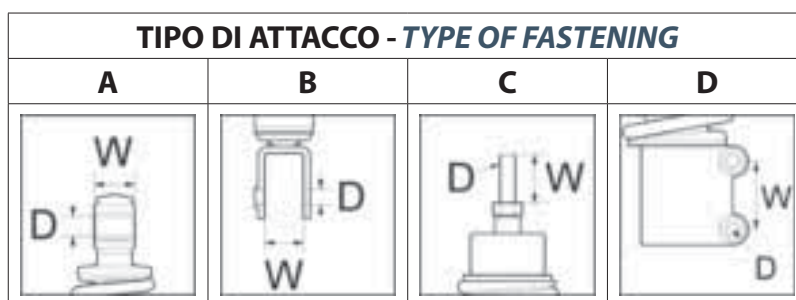



AMMORTIZZATORI SCOOTER OLTRE 50 CC OVER 50 CC SCOOTER SHOCK ABSORBERS

MARCA MODELLO - TRADEMARK MODEL	CODICE - CODE	MARCA MODELLO - TRADEMARK MODEL	CODICE - CODE
APRILIA 100: Scarabeo Minarelli - Yamaha 00 (R.O. AP8203946)	20 455 0042 	APRILIA 125: Scarabeo ie Light 07-12 200: Scarabeo Light 07-12 (R.O. JC62100X9200)	20 455 0442
APRILIA 125: Sport City 04-06 Sport City Cube 08-10 • Sport City Street 12 250: Scarabeo Light 06-08 • Sport City Cube 08-12 300: Scarabeo Light 09-10 • Sport City Street 12 (R.O. AP8164551)	20 455 0462 	APRILIA 125-150-200: Scarabeo Rotax (R.O. AP8163188)	20 455 0602
APRILIA 100: Scarabeo 4T 01-14 (R.O. 666265)	20 455 0642 	APRILIA 400-500: Scarabeo Light 06-08 (R.O. AP8163503)	20 455 0732
APRILIA 500: Scarabeo 03-06 (R.O. 8163328)	20 455 0742 	APRILIA 125: Sr Max 11-14 300: Sr Max 11-14 GILERA 125-250-300: Nexus 06-11 (R.O. 647524)	20 455 0752
HONDA 125: Dylan 01-06 • Nes 00-06 • Sh 01-12 150: Dylan 01-06 • Nes 00-06 • Sh 01-12 (R.O. 52400KTF641)	20 455 0312 	HONDA 250: Forza 05-07 • Jazz 01-05 300: Sh 07-15 (R.O. 52400KDW903)	20 455 0702

AMMORTIZZATORI SCOOTER OLTRE 50 CC
OVER 50 CC SCOOTER SHOCK ABSORBERS



MARCA MODELLO - TRADEMARK MODEL	CODICE - CODE	MARCA MODELLO - TRADEMARK MODEL	CODICE - CODE
HONDA 125-150: Pcx 10-15 (R.O. 52400KWN711)	20 455 0712 	HONDA 125: Sh 13-16 150: Sh 13-16 (R.O. 52400K01901)	20 455 0722
HONDA 125: Sh Mode 13-16 (R.O. 52400-K29-901)	20 455 0852 	KYMCO 125-150-200: Dink Classic 02-04 (R.O. 00165936)	20 455 0372
KYMCO 125: Agility R16 08-12 • 150: Agility R16 08-09 • 200: Agility R16 10-12 (R.O. 00152274)	20 455 0522 	KYMCO 200-300: Downtown i 09-11 (R.O. 00152254)	20 455 0532
KYMCO 125-200: People S 07-08 (R.O. 00166374NE)	20 455 0542 	KYMCO 250: People S 07 300: People S 08 (R.O. 00166375NE)	20 455 0552
KYMCO 200-300: People Gti 10-14 (R.O. 00152254)	20 455 0562 	KYMCO 125-200: Dink Eu 3 06-07 (R.O. 00165937)	20 455 0572



AMMORTIZZATORI SCOOTER OLTRE 50 CC OVER 50 CC SCOOTER SHOCK ABSORBERS

MARCA MODELLO - TRADEMARK MODEL	CODICE - CODE	MARCA MODELLO - TRADEMARK MODEL	CODICE - CODE
KYMCO 300: X Citing i R 08-09 • X Citing i 08 (R.O. 00152234)	20 455 0832 	KYMCO 125: K-Xct i 12-14 • 300: K-Xct i Abs 14 • K-Xct i 12 (R.O. 00152380N)	20 455 0762
KYMCO 500: X Citing R 09 • X Citing i R 07-08 X Citing i 08 (R.O. 00166176)	20 455 0842 	MBK 100: Ovetto 00-02 YAMAHA 100: Neo's 99-02 (R.O. 5KKF22100033)	20 455 0182
PEUGEOT 125: Geopolis Tutti - <i>All models</i> (R.O. 770375)	20 455 0812 	PEUGEOT 250-300: Geopolis Tutti - <i>All models</i> (R.O. 769092)	20 455 0822
PIAGGIO 125: Sfera 95-97 • Vespa Et4 96-98 (R.O. 564110)	20 455 0222 	PIAGGIO: Liberty Elettrico 11 • 125: Liberty 4T 08-15 • Liberty 01-02 • 150: Liberty 4T 08-13 • 200: Liberty 06 • Liberty 4T 06-08 (R.O. 56232R)	20 455 0282
PIAGGIO 125: Liberty 98-00 (R.O. 564949)	20 455 0352 	PIAGGIO 125-250: Beverly - Rst - Cruiser - Tourer 01-10 (R.O. 56174R)	20 455 0362

AMMORTIZZATORI SCOOTER OLTRE 50 CC

OVER 50 CC SCOOTER SHOCK ABSORBERS



MARCA MODELLO - TRADEMARK MODEL	CODICE - CODE	MARCA MODELLO - TRADEMARK MODEL	CODICE - CODE
PIAGGIO 125: Skipper 4T 00-02 • Vespa Et4 99-02 Vespa Lx 05-13 • Vespa Lxv 06-12 • Zip 00-02 150: Vespa Lx 05-13 (R.O. 56230R)	20 455 0432 	PIAGGIO 125: Vespa Gt 03-07 • Vespa Gts 07-16 150: Vespa Gts 4T 3V 14-15 200: Vespa Gt 06-07 • 250: Vespa Gts 05-16 300: Vespa Gts 08-15 • Vespa Gtv 10-13 (R.O. 58503R)	20 455 0512
PIAGGIO 125: X Evo 07-16 • X7 08 • X8 04-07 X8 Premium 06-07 200: X8 05-07 250: X8 05-08 • X Evo 07-16 • X7 08 (R.O. 646552)	20 455 0772 	PIAGGIO 125-350: X10 4T 4V ie Eu3 12-13 (R.O. 58607R)	20 455 0792
PIAGGIO 125-180-200-250: X9 • X9 Evolution (R.O. 56231R)	20 455 0782 	PIAGGIO 350: Beverly Sport - Touring 11-13 (R.O. 58583R)	20 455 0632
PIAGGIO 400: Beverly - Tourer 06-10 500: Beverly 02-08 • Beverly Cruiser 07-12 (R.O. 56210R)	20 455 0652 	PIAGGIO 125: Beverly Rst 10-15 300: Beverly Rst 10-15 (R.O. 58518R)	20 455 0662
PIAGGIO 125-200-250: Carnaby 07-10 300: Carnaby Cruiser 09-12 (R.O. 649423)	20 455 0672 	PIAGGIO 125-250-300: Beverly-Cruiser-Tourer-Rst (R.O. 601014)	20 455 0682



AMMORTIZZATORI SCOOTER OLTRE 50 CC OVER 50 CC SCOOTER SHOCK ABSORBERS

MARCA MODELLO - TRADEMARK MODEL	CODICE - CODE	MARCA MODELLO - TRADEMARK MODEL	CODICE - CODE
PIAGGIO 125: Sfera 95-97 • Vespa Et4 96-02 • Zip 00-02 (R.O. 598922)	20 458 4212 	PIAGGIO 125: Liberty 98-00 (R.O. 564949)	20 455 0352
	PIAGGIO 125-150: Vespa Lx - Touring 05-13 (R.O. 646959)	20 458 4372 	
PIAGGIO 125-150: Vespa Lx - Touring 05-13 (R.O. 646959)	20 458 4372 	PIAGGIO 125: Vespa Gt 03-07 • Vespa Gts 07-12 Vespa Gtv 07-08 • 200: Vespa Gt 06-07 250: Vespa Gt 06-07 • Vespa Gts 05-13 • Vespa Gtv 06-09 • 300: Vespa Gts 10-12 • Vespa Gtv 10-13 (R.O. 56286R)	20 458 4382
	AMMORTIZZATORE POSTERIORE REAR SHOCK ABSORBER	PIAGGIO 250: X9 00-01 (R.O. 564505)	20 455 0922
AMMORTIZZATORE POSTERIORE REAR SHOCK ABSORBER	PIAGGIO 250: X9 00-01 (R.O. 564505)	20 455 0922 	
SUZUKI 125-150: Ux Sixteen 08-11 (R.O. 6210020H01000)	20 455 0612 		YAMAHA 125: Majesty 98-06 150: Majesty 01-02 180: Majesty 03-06 (R.O. 5D5F2210033)
SUZUKI 125-200: Burgman 07-14 (R.O. 6210003H01000)	20 455 0622 	20 455 0622 	
YAMAHA 125: Ypr Xmax 06-09 250: Black Xmax • Ypr Xmax 05-09 (R.O. 1B9F22100200)	20 455 0482 	YAMAHA 125: Majesty 98-06 150: Majesty 01-02 180: Majesty 03-06 (R.O. 5D5F2210033)	20 455 0302
	YAMAHA 125: Ypr Xmax 06-09 250: Black Xmax • Ypr Xmax 05-09 (R.O. 1B9F22100200)	20 455 0482 	
YAMAHA 125: Ypr Xmax 06-09 250: Black Xmax • Ypr Xmax 05-09 (R.O. 1B9F22100200)	20 455 0482 	YAMAHA 125: Ypr Xmax 10-13 250: Ypr Xmax 10-13 (R.O. 37PF22100000)	20 455 0502
	YAMAHA 125: Ypr Xmax 06-09 250: Black Xmax • Ypr Xmax 05-09 (R.O. 1B9F22100200)	20 455 0482 	
	YAMAHA 125: Ypr Xmax 06-09 250: Black Xmax • Ypr Xmax 05-09 (R.O. 1B9F22100200)	20 455 0482 	

AMMORTIZZATORI SCOOTER OLTRE 50 CC
OVER 50 CC SCOOTER SHOCK ABSORBERS



MARCA MODELLO - TRADEMARK MODEL

CODICE - CODE

MARCA MODELLO - TRADEMARK MODEL

CODICE - CODE

YAMAHA 250: Majesty 00-03
(R.O. 5GM22210000)

20 455 0332



YAMAHA 250: Vp Xcity 09-15
(R.O. 5B2F221020)

20 455 0492



YAMAHA 250: Vp Xcity 07-08
(R.O. 5B2F22101000)

20 455 0802



YAMAHA 400: Yp Majesty 04-11
Yp Majesty Abs 07-11
(R.O. 5RU222101000)

20 455 0342



YAMAHA 400: Yp R X-Max 13-15
Yp Ra X-Max Abs 13-15
(R.O. 1SDF22101000)

20 455 0912





AMMORTIZZATORI SCOOTER OLTRE 50 CC OVER 50 CC SCOOTER SHOCK ABSORBERS

CODICE RMS RMS CODE	MODELLO MODEL	CC	ANNI YEARS	RIF ORIGINALE OEM NUMBER	ANT POST FRONT REAR	L (mm)	ATTACCO SUPERIORE UPPER FASTENING POINT			ATTACCO INFERIORE LOWER FASTENING POINT		
							Tipo Type	D (mm)	W (mm)	Tipo Type	D (mm)	W (mm)
APRILIA												
20 455 0642	Scarabeo 4t	100	01-14	666265	Post-Rear	345	A	10,1	21,6	B	10,1	33
20 455 0642	Scarabeo 4t Net	100	10	666265	Post-Rear	345	A	10,1	21,6	B	10,1	33
20 455 0642	Scarabeo 4t Rst	100	06-09	666265	Post-Rear	345	A	10,1	21,6	B	10,1	33
20 455 0042	Scarabeo Mot Minarelli	100	00	AP8203946	Post-Rear	290	A	10,2	20	B	M8 x 1.25	20
20 455 0042	Scarabeo Mot Yamaha	100	00	AP8203946	Post-Rear	290	A	10,2	20	B	M8 x 1.25	20
20 455 0442	Scarabeo ie Light	125	07-12	JC62100X9000	Post-Rear	344	A	8	21	A	10,1	24
20 455 0602	Scarabeo Motore Rotax	125	99-04	AP8163188	Post-Rear	390	A	10,15	21	B	10,1	30
20 455 0462	Sport City	125	04-06	AP8164551	Post-Rear	345	A	8	21	A	14,1	24
20 455 0462	Sport City Cube	125	08-10	AP8164551	Post-Rear	345	A	8	21	A	14,1	24
20 455 0462	Sport City Eu3	125	06-08	AP8164551	Post-Rear	345	A	8	21	A	14,1	24
20 455 0462	Sport City Street	125	12	AP8164551	Post-Rear	345	A	8	21	A	14,1	24
20 455 0752	Sr Max	125	11-14	647524	Post-Rear	334	A	10,5	30	A	10,5	30
20 455 0602	Scarabeo Mot Rotax	150	99-04	AP8163188	Post-Rear	390	A	10,15	21	B	10,1	30
20 455 0442	Scarabeo ie Light	200	11-12	JC62100X9000	Post-Rear	344	A	8	21	A	10,1	24
20 455 0442	Scarabeo Light	200	07-08	JC62100X92000	Post-Rear	344	A	8	21	A	10,1	24
20 455 0602	Scarabeo Mot Rotax	200	99-04	AP8163188	Post-Rear	390	A	10,15	21	B	10,1	30
20 455 0462	Scarabeo Light	250	06-08	AP8164551	Post-Rear	345	A	8	21	A	14,1	24
20 455 0462	Sport City Cube	250	08-12	AP8164551	Post-Rear	345	A	8	21	A	14,1	24
20 455 0462	Scarabeo Light	300	09-10	AP8164551	Post-Rear	345	A	8	21	A	14,1	24
20 455 0462	Sport City Street	300	12	AP8164551	Post-Rear	345	A	8	21	A	14,1	24
20 455 0752	Sr Max	300	11-14	647524	Post-Rear	334	A	10,5	30	A	10,5	30
20 455 0732	Scarabeo Light	400	06-08	AP8163503	Post-Rear	377	A	10,5	30	A	10,5	30
20 455 0742	Scarabeo	500	03-06	8163328	Post-Rear	390	A	10,2	21	A	10,2	30
20 455 0732	Scarabeo Light	500	06-08	AP8163503	Post-Rear	377	A	10,5	30	A	10,5	30
GILERA												
20 455 0752	Nexus Eu3	125	07-08	647524	Post-Rear	334	A	10,5	30	A	10,5	30
20 455 0752	Nexus Eu3 ie	125	09-11	647524	Post-Rear	334	A	10,5	30	A	10,5	30
20 455 0752	Nexus Eu3	250	06	647524	Post-Rear	334	A	10,5	30	A	10,5	30
20 455 0752	Nexus Sp Eu3	250	06-07	647524	Post-Rear	334	A	10,5	30	A	10,5	30
20 455 0752	Nexus Eu3	300	08-11	647524	Post-Rear	334	A	10,5	30	A	10,5	30
HONDA												
20 455 0312	Dylan	125	01-06	52400KTF641	Post-Rear	308	A	10,1	20	B	M8 x 1.25	20
20 455 0312	Nes	125	00-06	52400KTF641	Post-Rear	308	A	10,1	20	B	M8 x 1.25	20
20 455 0712	Pcx	125	10-15	52400-KWN-711	Post-Rear	311	A	10,15	21	B	M8 x 1.25	20
20 455 0312	Sh	125	01-04	52400KTF641	Post-Rear	308	A	10,1	20	B	M8 x 1.25	20
20 455 0312	Sh i	125	05-12	52400KTF641	Post-Rear	308	A	10,1	20	B	M8 x 1.25	20
20 455 0722	Sh i	125	13-16	52400-K01-901	Post-Rear	377	A	10,15	21	B	M8 x 1.25	20
20 455 0852	Sh Mode	125	13-16	52400-K29-901	Post-Rear	315	A	10,5	21	B	M8 x 1,25	20
20 455 0312	Dylan	150	01-06	52400KTF641	Post-Rear	308	A	10,1	20	B	M8 x 1.25	20
20 455 0312	Nes	150	00-06	52400KTF641	Post-Rear	308	A	10,1	20	B	M8 x 1.25	20
20 455 0712	Pcx	150	10-15	52400-KWN-711	Post-Rear	311	A	10,15	21	B	M8 x 1.25	20
20 455 0312	Sh	150	01-04	52400KTF641	Post-Rear	308	A	10,1	20	B	M8 x 1.25	20
20 455 0312	Sh i	150	05-12	52400KTF641	Post-Rear	308	A	10,1	20	B	M8 x 1.25	20
20 455 0722	Sh i	150	13-16	52400-K01-901	Post-Rear	377	A	10,15	21	B	M8 x 1.25	20
20 455 0702	Forza	250	05-07	52400-KTW-903	Post-Rear	404	A	10,1	20,5	B	M10x1.25	27
20 455 0702	Jazz	250	01-05	52400-KTW-903	Post-Rear	404	A	10,1	20,5	B	M10x1.25	27
20 455 0702	Sh	300	07-15	52400-KTW-903	Post-Rear	404	A	10,1	20,5	B	M10x1.25	27
KYMCO												
20 455 0522	Agility R16	125	08-12	00152274	Post-Rear	326	A	10,15	21	B	M8 x 1.25	20

AMMORTIZZATORI SCOOTER OLTRE 50 CC

OVER 50 CC SCOOTER SHOCK ABSORBERS



CODICE RMS <i>RMS CODE</i>	MODELLO <i>MODEL</i>	CC	ANNI <i>YEARS</i>	RIF ORIGINALE <i>OEM NUMBER</i>	ANT POST FRONT REAR	L (mm)	ATTACCO SUPERIORE <i>UPPER FASTENING POINT</i>			ATTACCO INFERIORE <i>LOWER FASTENING POINT</i>		
							Tipo <i>Type</i>	D (mm)	W (mm)	Tipo <i>Type</i>	D (mm)	W (mm)
20 455 0372	Dink Classic	125	02	00165936	Post-Rear	280	A	10,15	21	B	M8 x 1.25	20
20 455 0372	Dink Classic Eu2	125	03	00165936	Post-Rear	280	A	10,15	21	B	M8 x 1.25	20
20 455 0572	Dink Eu3	125	06-07	00165937	Post-Rear	320	A	10,15	21	B	M8 x 1.25	20
20 455 0542	People S Dd Eu3	125	07-08	00166374NE	Post-Rear	328	A	10,15	21	B	M8 x 1.25	20
20 455 0762	K-Xct i	125	12-14	00152380N	Post-Rear	390	A	10,2	21	B	M10x1,25	26,5
20 455 0522	Agility R16	150	08-09	00152274	Post-Rear	326	A	10,15	21	B	M8 x 1.25	20
20 455 0522	Agility R16	200	10-12	00152274	Post-Rear	326	A	10,15	21	B	M8 x 1.25	20
20 455 0372	Dink Classic	200	04	00165936	Post-Rear	280	A	10,15	21	B	M8 x 1.25	20
20 455 0572	Dink Eu3 i	200	06-07	00165937	Post-Rear	320	A	10,15	21	B	M8 x 1.25	20
20 455 0532	Downtown i	200	10	00152254	Post-Rear	390	A	10,15	21	B	M10x1.25	26,5
20 455 0562	People Gti	200	10-14	00152277	Post-Rear	398	A	10,15	21	B	M10x1.25	26,5
20 455 0542	People Si	200	07	00166374NE	Post-Rear	328	A	10,15	21	B	M8 x 1.25	20
20 455 0552	People Si	250	07	00166375NE	Post-Rear	394	A	10,15	21	B	M10x1.25	23
20 455 0532	Downtown i	300	09-11	00152254	Post-Rear	390	A	10,15	21	B	M10x1.25	26,5
20 455 0562	People Gti	300	10-14	00152277	Post-Rear	398	A	10,15	21	B	M10x1.25	26,5
20 455 0552	People S i	300	08	00166375NE	Post-Rear	394	A	10,15	21	B	M10x1.25	23
20 455 0762	K-Xct i	300	12	00152380N	Post-Rear	390	A	10,2	21	B	M10x1,25	26,5
20 455 0762	K-Xct i Abs	300	14	00152380N	Post-Rear	390	A	10,2	21	B	M10x1,25	26,5
20 455 0832	X Citing R	300	08-09	00152234	Post-Rear	387	A	10,2	21	B	M10x1,25	26,5
20 455 0832	X Citing	300	08	00152234	Post-Rear	387	A	10,2	21	B	M10x1,25	26,5
20 455 0842	X Citing R	500	09	00166176	Post-Rear	387	A	10,2	21	B	M10x1,25	26,5
20 455 0842	X Citing i R	500	07-08	00166176	Post-Rear	387	A	10,2	21	B	M10x1,25	26,5
20 455 0842	X Citing i	500	08	00166176	Post-Rear	387	A	10,2	21	B	M10x1,25	26,5
MBK												
20 455 0182	Ovetto	100	00-02	5KKF22100033	Post-Rear	280	A	10,1	20	B	M8 x 1.25	20
PEUGEOT												
20 455 0812	Geo C	125		770375	Post-Rear	260	A	10,1	21	B	M10x1.25	20
20 455 0812	Geo Es	125		770375	Post-Rear	260	A	10,1	21	B	M10x1.25	20
20 455 0812	Geo Exn	125		770375	Post-Rear	260	A	10,1	21	B	M10x1.25	20
20 455 0812	Geo Ex	125		770375	Post-Rear	260	A	10,1	21	B	M10x1.25	20
20 455 0812	Geo E	125		770375	Post-Rear	260	A	10,1	21	B	M10x1.25	20
20 455 0812	Geo Sc	125		770375	Post-Rear	260	A	10,1	21	B	M10x1.25	20
20 455 0812	Geo S	125		770375	Post-Rear	260	A	10,1	21	B	M10x1.25	20
20 455 0812	Geo X	125		770375	Post-Rear	260	A	10,1	21	B	M10x1.25	20
20 455 0812	Geo	125		770375	Post-Rear	260	A	10,1	21	B	M10x1.25	20
20 455 0822	Geo C	250		769092	Post-Rear	352	A	10,1	21	A	14,1	24
20 455 0822	Geo SC	250		769092	Post-Rear	352	A	10,1	21	A	14,1	24
20 455 0822	Geo S	250		769092	Post-Rear	352	A	10,1	21	A	14,1	24
20 455 0822	Geo X	250		769092	Post-Rear	352	A	10,1	21	A	14,1	24
20 455 0822	Geo	250		769092	Post-Rear	352	A	10,1	21	A	14,1	24
20 455 0822	Geo St	300		769092	Post-Rear	352	A	10,1	21	A	14,1	24
20 455 0822	Geo Xn	300		769092	Post-Rear	352	A	10,1	21	A	14,1	24
20 455 0822	Geo X	300		769092	Post-Rear	352	A	10,1	21	A	14,1	24
20 455 0822	Geo	300		769092	Post-Rear	352	A	10,1	21	A	14,1	24
PIAGGIO												
20 455 0282	Liberty Elettrico	-	11	56232R	Post-Rear	318	C	M8 x 1.0	25	A	10,2	30
20 455 0362	Beverly	125	01-03	56174R	Post-Rear	339	A	10,1	30	B	14,1	24
20 455 0362	Beverly Eu3	125	07-08	56174R	Post-Rear	339	A	10,1	30	B	14,1	24
20 455 0362	Beverly Eu3 Mic	125	07	56174R	Post-Rear	339	A	10,1	30	B	14,1	24
20 455 0683	Beverly Eu3 Mic	125	07-08	601014	Post-Rear	338	A	10,5	30	A	14,1	24



AMMORTIZZATORI SCOOTER OLTRE 50 CC OVER 50 CC SCOOTER SHOCK ABSORBERS

CODICE RMS RMS CODE	MODELLO MODEL	CC	ANNI YEARS	RIF ORIGINALE OEM NUMBER	ANT POST FRONT REAR	L (mm)	ATTACCO SUPERIORE UPPER FASTENING POINT			ATTACCO INFERIORE LOWER FASTENING POINT		
							Tipo Type	D (mm)	W (mm)	Tipo Type	D (mm)	W (mm)
20 455 0683	Beverly Eu3 Sport	125	07-08	601014	Post-Rear	338	A	10,5	30	A	14,1	24
20 455 0683	Beverly Rst	125	04-07	601014	Post-Rear	338	A	10,5	30	A	14,1	24
20 455 0662	Beverly Rst 4t 4v ie Eu3	125	10-15	58518R	Post-Rear	346	A	10,5	30	A	14,1	24
20 455 0683	Beverly Rst 4t 4v ie Eu3	125	10-11	601014	Post-Rear	338	A	10,5	30	A	14,1	24
20 455 0683	Beverly Tourer Eu3	125	08-10	601014	Post-Rear	338	A	10,5	30	A	14,1	24
20 455 0672	Carnaby	125	07-10	649423	Post-Rear	348	A	8	21	A	14,1	24
20 455 0282	Liberty	125	01-02	56232R	Post-Rear	318	C	M8 x 1.0	25	A	10,2	30
20 455 0352	Liberty	125	98-00	564949	Post-Rear	329	C	M8 x 1.0	20,5	B	10,1	37
20 455 0282	Liberty 4t	125	06-15	56232R	Post-Rear	318	C	M8 x 1.0	25	A	10,2	30
20 455 0282	Liberty 4t 2v Eu3	125	09-12	56232R	Post-Rear	318	C	M8 x 1.0	25	A	10,2	30
20 455 0282	Liberty 4t 2v ie Eu3 Ptt-Ita	125	12	56232R	Post-Rear	318	C	M8 x 1.0	25	A	10,2	30
20 455 0282	Liberty 4t Eu3	125	07-08	56232R	Post-Rear	318	C	M8 x 1.0	25	A	10,2	30
20 455 0282	Liberty 4t Eu3	125	08	56232R	Post-Rear	318	C	M8 x 1.0	25	A	10,2	30
20 455 0282	Liberty 4t Eu3 Delivery Single	125	07-12	56232R	Post-Rear	318	C	M8 x 1.0	25	A	10,2	30
20 455 0282	Liberty 4t Eu3 Delivery Tnt	125	06-08	56232R	Post-Rear	318	C	M8 x 1.0	25	A	10,2	30
20 455 0282	Liberty 4t Sport Eu3	125	06-08	56232R	Post-Rear	318	C	M8 x 1.0	25	A	10,2	30
20 455 0282	Liberty Rst	125	04-05	56232R	Post-Rear	318	C	M8 x 1.0	25	A	10,2	30
20 455 0282	Liberty Rst Ptt	125	05-11	56232R	Post-Rear	318	C	M8 x 1.0	25	A	10,2	30
20 455 0282	Liberty Sport	125	06	56232R	Post-Rear	318	C	M8 x 1.0	25	A	10,2	30
20 455 0352	Liberty	125	98-00	564949	Post-Rear	330	C	M8 x 1.0	20,5	B	10,1	37
20 455 0222	Sfera	125	95-97	564110	Post-Rear	325	C	M8 x 1.0	25	B	10,1	33
20 455 0432	Skipper 4t	125	00-02	56230R	Post-Rear	322,5	C	M8 x 1.0	21	B	10,2	30,5
20 458 4242	Vespa	125	67-82	1379364	Ant-Front	217	C	M8 x 1.0	25	A	14,1	40
20 455 0222	Vespa Et4	125	96-98	564110	Post-Rear	325	C	M8 x 1.0	25	B	10,1	33
20 455 0432	Vespa Et4	125	99-02	56230R	Post-Rear	322,5	C	M8 x 1.0	21	B	10,2	30,5
20 455 0512	Vespa Granturismo	125	03-07	58503R	Post-Rear	348	C	M8 x 1.0	25	A	14,1	24
20 458 4382	Vespa Granturismo	125	03-07	56286R	Ant-Front	291	C	M10 x 1.25	16	D	M8 x 1.25	35
20 455 0512	Vespa Granturismo Eu3	125	06-07	58503R	Post-Rear	348	C	M8 x 1.0	25	A	14,1	24
20 458 4382	Vespa Granturismo Eu3	125	06-07	56286R	Ant-Front	291	C	M10 x 1.25	16	D	M8 x 1.25	35
20 455 0512	Vespa Gts 4t ie Super	125	09-15	58503R	Post-Rear	348	C	M8 x 1.0	25	A	14,1	24
20 455 0512	Vespa Gts Eu3	125	07-12	58503R	Post-Rear	348	C	M8 x 1.0	25	A	14,1	24
20 458 4252	Vespa Vespa Primavera Et3	125	-	-	Ant-Front	229	C	M8 x 1.0	16	A	14,1	40
20 458 4382	Vespa Gts Eu3	125	07-12	56286R	Ant-Front	291	C	M10 x 1.25	16	D	M8 x 1.25	35
20 458 4382	Vespa Gtv	125	07-08	56286R	Ant-Front	291	C	M10 x 1.25	16	D	M8 x 1.25	35
20 458 4382	Vespa Gtv 4t Navy Eu3	125	08	56286R	Ant-Front	291	C	M10 x 1.25	16	D	M8 x 1.25	35
20 455 0432	Vespa Lx	125	05-06	56230R	Post-Rear	322,5	C	M8 x 1.0	21	B	10,2	30,5
20 458 4372	Vespa Lx	125	05-06	646959	Ant-Front	266	C	M10 x 1.25	15	D	M8 x 1.25	35
20 455 0432	Vespa Lx 3v ie-Touring	125	12-13	56230R	Post-Rear	322,5	C	M8 x 1.0	21	B	10,2	30,5
20 458 4372	Vespa Lx 3v ie-Touring	125	12-13	646959	Ant-Front	266	C	M10 x 1.25	15	D	M8 x 1.25	35
20 455 0432	Vespa Lx 4t Eu3 Touring	125	10-11	56230R	Post-Rear	322,5	C	M8 x 1.0	21	B	10,2	30,5
20 458 4372	Vespa Lx 4t Eu3 Touring	125	10-11	646959	Ant-Front	266	C	M10 x 1.25	15	D	M8 x 1.25	35
20 455 0432	Vespa Lx 4t FL	125	09	56230R	Post-Rear	322,5	C	M8 x 1.0	21	B	10,2	30,5
20 458 4372	Vespa Lx 4t FL	125	09	646959	Ant-Front	266	C	M10 x 1.25	15	D	M8 x 1.25	35
20 455 0432	Vespa Lx Eu3	125	06-08	56230R	Post-Rear	322,5	C	M8 x 1.0	21	B	10,2	30,5
20 455 0432	Vespa Lx Eu3 ie	125	09-10	56230R	Post-Rear	322,5	C	M8 x 1.0	21	B	10,2	30,5
20 455 0432	Vespa Lxv 4t Eu3	125	06-09	56230R	Post-Rear	322,5	C	M8 x 1.0	21	B	10,2	30,5
20 455 0432	Vespa Lxv 4t Navy Eu3	125	08	56230R	Post-Rear	322,5	C	M8 x 1.0	21	B	10,2	30,5
20 455 0432	Vespa Lxv ie 4t	125	10-12	56230R	Post-Rear	322,5	C	M8 x 1.0	21	B	10,2	30,5
20 455 0782	X9 Evolution Eu3	125	07	56231R	Post-Rear	340	A	10,5	30	A	14,1	24

AMMORTIZZATORI SCOOTER OLTRE 50 CC

OVER 50 CC SCOOTER SHOCK ABSORBERS



CODICE RMS <i>RMS CODE</i>	MODELLO <i>MODEL</i>	CC	ANNI <i>YEARS</i>	RIF ORIGINALE <i>OEM NUMBER</i>	ANT POST FRONT REAR	L (mm)	ATTACCO SUPERIORE <i>UPPER FASTENING POINT</i>			ATTACCO INFERIORE <i>LOWER FASTENING POINT</i>		
							Tipo <i>Type</i>	D (mm)	W (mm)	Tipo <i>Type</i>	D (mm)	W (mm)
20 455 0782	X9 Evolution	125	03-06	56231R	Post-Rear	340	A	10,5	30	A	14,1	24
20 455 0782	X9	125	01-02	56231R	Post-Rear	340	A	10,5	30	A	14,1	24
20 455 0772	X Evo	125	07-16	646552	Post-Rear	350	A	10,5	30	A	10,5	30
20 455 0772	X7 Eu3	125	08	646552	Post-Rear	350	A	10,5	30	A	10,5	30
20 455 0772	X8 Premium Eu2	125	06	646552	Post-Rear	350	A	10,5	30	A	10,5	30
20 455 0772	X8 Premium Eu3	125	06-07	646552	Post-Rear	350	A	10,5	30	A	10,5	30
20 455 0772	X8	125	04-06	646552	Post-Rear	350	A	10,5	30	A	10,5	30
20 455 0792	X10 4T ie Eu3	125	12-13	58607R	Post-Rear	430	A	10,5	30	A	14,1	24
20 455 0432	Zip	125	00-02	56230R	Post-Rear	322,5	C	M8 x 1.0	21	B	10,2	30,5
20 458 4212	Sfera	125	95-97	598922	Ant-Front	264	C	M8 x 125	14	D	M8	35
20 458 4212	Vespa Et4	125	96-02	598922	Ant-Front	264	C	M8 x 125	14	D	M8	35
20 458 4212	Zip	125	00-02	598922	Ant-Front	264	C	M8 x 125	14	D	M8	35
20 458 4212	Sfera	125	95-97	598922	Ant-Front	264	C	M10x1,25	14	D	M8x1,25	35
20 458 4212	Vespa Et4	125	96-02	598922	Ant-Front	264	C	M10x1,25	14	D	M8x1,25	35
20 458 4212	Zip	125	00-02	598922	Ant-Front	264	C	M10x1,25	14	D	M8x1,25	35
20 458 4302	Vespa FL	125	89-90	-	Ant-Front	253	C	M10 x 1.25	17	D	M8 x 1.25	35
20 458 4302	Vespa Pk XL	125	86-89	-	Ant-Front	253	C	M10 x 1.25	17	D	M8 x 1.25	35
20 455 0512	Vespa Gts ie 4T 3V	150	14-15	58503R	Post-Rear	348	C	M8 x 1.0	25	A	14,1	24
20 455 0282	Liberty 4t Eu3	150	07-08	56232R	Post-Rear	318	C	M8 x 1.0	25	A	10,2	30
20 455 0282	Liberty 4t Sport Eu3	150	08	56232R	Post-Rear	318	C	M8 x 1.0	25	A	10,2	30
20 455 0282	Liberty Moc 4t	150	09-13	56232R	Post-Rear	318	C	M8 x 1.0	25	A	10,2	30
20 455 0432	Vespa Lx	150	05-06	56230R	Post-Rear	322,5	C	M8 x 1.0	21	B	10,2	30,5
20 458 4372	Vespa Lx	150	05-06	646959	Ant-Front	266	C	M10 x 1.25	15	D	M8 x 1.25	35
20 455 0432	Vespa Lx 3v ie-Touring	150	12-13	56230R	Post-Rear	322,5	C	M8 x 1.0	21	B	10,2	30,5
20 458 4372	Vespa Lx 3v ie-Touring	150	12-13	646959	Ant-Front	266	C	M10 x 1.25	15	D	M8 x 1.25	35
20 455 0432	Vespa Lx 4t FL	150	09	56230R	Post-Rear	322,5	C	M8 x 1.0	21	B	10,2	30,5
20 458 4372	Vespa Lx 4t FL	150	09	646959	Ant-Front	266	C	M10 x 1.25	15	D	M8 x 1.25	35
20 455 0432	Vespa Lx Eu3	150	06-08	56230R	Post-Rear	322,5	C	M8 x 1.0	21	B	10,2	30,5
20 455 0432	Vespa Lx Eu3 ie	150	09-11	56230R	Post-Rear	322,5	C	M8 x 1.0	21	B	10,2	30,5
20 458 4372	Vespa Lx Eu3 ie	150	09-11	646959	Ant-Front	266	C	M10 x 1.25	15	D	M8 x 1.25	35
20 455 0432	Vespa Lx Touring	150	10-12	56230R	Post-Rear	322,5	C	M8 x 1.0	21	B	10,2	30,5
20 458 4372	Vespa Lx Touring	150	10-12	646959	Ant-Front	266	C	M10 x 1.25	15	D	M8 x 1.25	35
20 455 0782	X9 Amalfi	180	00-03	56231R	Post-Rear	340	A	10,5	30	A	14,1	24
20 455 0672	Carnaby	200	07-08	649423	Post-Rear	348	A	8	21	A	14,1	24
20 455 0282	Liberty	200	06	56232R	Post-Rear	318	C	M8 x 1.0	25	A	10,2	30
20 455 0282	Liberty Rst	200	04	56232R	Post-Rear	318	C	M8 x 1.0	25	A	10,2	30
20 455 0282	Liberty Sport	200	06-07	56232R	Post-Rear	318	C	M8 x 1.0	25	A	10,2	30
20 455 0512	Vespa Granturismo	200	06-07	58503R	Post-Rear	348	C	M8 x 1.0	25	A	14,1	24
20 458 4382	Vespa Granturismo	200	06-07	56286R	Ant-Front	291	C	M10 x 1.25	16	D	M8 x 1.25	35
20 455 0772	X8	200	05-07	646552	Post-Rear	350	A	10,5	30	A	10,5	30
20 455 0782	X9 Evolution	200	03	56231R	Post-Rear	340	A	10,5	30	A	14,1	24
20 455 0782	X9	200	02-03	56231R	Post-Rear	340	A	10,5	30	A	14,1	24
20 455 0362	Beverly	250	06-07	56174R	Post-Rear	339	A	10,1	30	B	14,1	24
20 455 0362	Beverly Cruiser	250	07-09	56174R	Post-Rear	339	A	10,1	30	B	14,1	24
20 455 0362	Beverly Eu3 Mic	250	07	56174R	Post-Rear	339	A	10,1	30	B	14,1	24
20 455 0362	Beverly ie Eu3	250	06-08	56174R	Post-Rear	339	A	10,1	30	B	14,1	24
20 455 0683	Beverly Rst	250	04-05	601014	Post-Rear	338	A	10,5	30	A	14,1	24
20 455 0362	Beverly Tourer Eu3	250	08-09	56174R	Post-Rear	339	A	10,1	30	B	14,1	24
20 455 0672	Carnaby	250	08	649423	Post-Rear	348	A	8	21	A	14,1	24
20 455 0512	Vespa Gt 60 Eu3	250	06-07	58503R	Post-Rear	348	C	M8 x 1.0	25	A	14,1	24



AMMORTIZZATORI SCOOTER OLTRE 50 CC OVER 50 CC SCOOTER SHOCK ABSORBERS

CODICE RMS RMS CODE	MODELLO MODEL	CC	ANNI YEARS	RIF ORIGINALE OEM NUMBER	ANT POST FRONT REAR	L (mm)	ATTACCO SUPERIORE UPPER FASTENING POINT			ATTACCO INFERIORE LOWER FASTENING POINT		
							Tipo Type	D (mm)	W (mm)	Tipo Type	D (mm)	W (mm)
20 458 4382	Vespa Gt 60 Eu3	250	06-07	56286R	Ant-Front	291	C	M10 x 1.25	16	D	M8 x 1.25	35
20 455 0512	Vespa Gts, Gts Abs	250	05-13	58503R	Post-Rear	348	C	M8 x 1.0	25	A	14,1	24
20 458 4382	Vespa Gts, Gts Abs	250	05-13	56286R	Ant-Front	291	C	M10 x 1.25	16	D	M8 x 1.25	35
20 458 4382	Vespa Gtv	250	06-09	56286R	Ant-Front	291	C	M10 x 1.25	16	D	M8 x 1.25	35
20 458 4382	Vespa Gtv 4t Navy Eu3	250	08	56286R	Ant-Front	291	C	M10 x 1.25	16	D	M8 x 1.25	35
20 455 0772	X Evo	250	07-16	646552	Post-Rear	350	A	10,5	30	A	10,5	30
20 455 0772	X7 Eu3	250	08	646552	Post-Rear	350	A	10,5	30	A	10,5	30
20 455 0772	X8 Eu3	250	05-08	646552	Post-Rear	350	A	10,5	30	A	10,5	30
20 455 0782	X9 Evolution	250	04-06	56231R	Post-Rear	340	A	10,5	30	A	14,1	24
20 455 0683	Beverly 300 ie Tourer	300	-	601014	Post-Rear	338	A	10,5	30	A	14,1	24
20 455 0662	Beverly Rst 4t 4v ie Eu3	300	10-15	58518R	Post-Rear	346	A	10,5	30	A	14,1	24
20 455 0683	Beverly Rst 4t 4v ie Eu3	300	10-12	601014	Post-Rear	338	A	10,5	30	A	14,1	24
20 455 0683	Beverly Tourer Eu3	300	09-10	601014	Post-Rear	338	A	10,5	30	A	14,1	24
20 455 0672	Carnaby Cruiser	300	09-12	649423	Post-Rear	348	A	8	21	A	14,1	24
20 455 0512	Vespa Gts ie	300	10-12	58503R	Post-Rear	348	C	M8 x 1.0	25	A	14,1	24
20 458 4382	Vespa Gts ie	300	10-12	56286R	Ant-Front	291	C	M10 x 1.25	16	D	M8 x 1.25	35
20 455 0512	Vespa Gts ie Touring	300	11-12	58503R	Post-Rear	348	C	M8 x 1.0	25	A	14,1	24
20 458 4382	Vespa Gts ie Touring	300	11-12	56286R	Ant-Front	291	C	M10 x 1.25	16	D	M8 x 1.25	35
20 455 0512	Vespa Gts Super	300	08-15	58503R	Post-Rear	348	C	M8 x 1.0	25	A	14,1	24
20 455 0512	Vespa Gts Super Sport	300	10-13	58503R	Post-Rear	348	C	M8 x 1.0	25	A	14,1	24
20 455 0512	Vespa Gtv 4t 4v ie	300	10-13	58503R	Post-Rear	348	C	M8 x 1.0	25	A	14,1	24
20 458 4382	Vespa Gtv 4t 4v ie	300	10-13	56286R	Ant-Front	291	C	M10 x 1.25	16	D	M8 x 1.25	35
20 455 0512	Vespa Gtv Montenapo- leone	300	10	58503R	Post-Rear	348	C	M8 x 1.0	25	A	14,1	24
20 458 4382	Vespa Gtv Montenapo- leone	300	10	56286R	Ant-Front	291	C	M10 x 1.25	16	D	M8 x 1.25	35
20 455 0632	Beverly 4t 4v ie Eu3 Sport	350	11-13	58583R	Post-Rear	340	A	10,1	20	B	M10x1.25	20
20 455 0632	Beverly 4t 4v ie Eu3 Touring	350	11-13	58583R	Post-Rear	340	A	10,1	20	B	M10x1.25	20
20 455 0792	X10 4T ie Eu3	350	12-13	58607R	Post-Rear	430	A	10,5	30	A	14,1	24
20 455 0652	Beverly Eu3	400	06-07	56210R	Post-Rear	377	A	10,5	30	A	10,5	30
20 455 0652	Beverly Tourer Eu3	400	08-10	56210R	Post-Rear	377	A	10,5	30	A	10,5	30
20 455 0652	Beverly Cruiser	500	07-12	56210R	Post-Rear	377	A	10,5	30	A	10,5	30
20 455 0652	Beverly Eu3	500	02-06	56210R	Post-Rear	377	A	10,5	30	A	10,5	30
20 455 0652	Beverly Eu3	500	06-08	56210R	Post-Rear	377	A	10,5	30	A	10,5	30
20 455 0282	Liberty Elettrico Ppt Aut	-	11	56232R	Post-Rear	318	C	M8 x 1.0	25	A	10,2	30
SUZUKI												
20 455 0622	Burgman K7-L0	125	07-10	62100-03H01-000	Post-Rear	340	A	10,1	20	B	M10x1.25	20
20 455 0622	Burgman L1-L2	125	11-12	62100-03H01-000	Post-Rear	340	A	10,1	20	B	M10x1.25	20
20 455 0622	Burgman L3-L4	125	13-14	62100-03H01-000	Post-Rear	340	A	10,1	20	B	M10x1.25	20
20 455 0612	Ux Sixteen K8-L0	125	08-10	62100-20H01-000	Post-Rear	325	A	10,1	20	B	M10x1.25	20
20 455 0612	Ux Sixteen L1	125	11	62100-20H01-000	Post-Rear	325	A	10,1	20	B	M10x1.25	20
20 455 0612	Ux Sixteen K8-L0	150	08-10	62100-20H01-000	Post-Rear	325	A	10,1	20	B	M10x1.25	20
20 455 0612	Ux Sixteen L1	150	11	62100-20H01-000	Post-Rear	325	A	10,1	20	B	M10x1.25	20
20 455 0622	Burgman K7-L0	200	07-10	62100-03H01-000	Post-Rear	340	A	10,1	20	B	M10x1.25	20
20 455 0622	Burgman L1	200	11-12	62100-03H01-000	Post-Rear	340	A	10,1	20	B	M10x1.25	20
20 455 0622	Burgman L3	200	13	62100-03H01-000	Post-Rear	340	A	10,1	20	B	M10x1.25	20
YAMAHA												
20 455 0182	Neo's	100	99-02	5KKF22100033	Post-Rear	280	A	10,1	20	B	M8 x 1.25	20
20 455 0302	Majesty	125	03-06	5D5F2210033	Post-Rear	336	A	10,1	20	B	M8 x 1.25	20
20 455 0302	Majesty	125	98-02	5D5F2210033	Post-Rear	336	A	10,1	20	B	M8 x 1.25	20

AMMORTIZZATORI SCOOTER OLTRE 50 CC OVER 50 CC SCOOTER SHOCK ABSORBERS

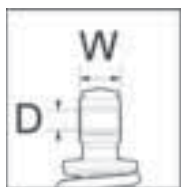
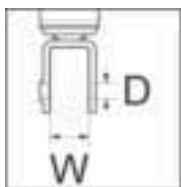
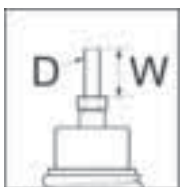
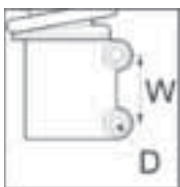

CODICE RMS RMS CODE	MODELLO MODEL	CC	ANNI YEARS	RIF ORIGINALE OEM NUMBER	ANT POST FRONT REAR	L (mm)	ATTACCO SUPERIORE UPPER FASTENING POINT			ATTACCO INFERIORE LOWER FASTENING POINT		
							Tipo Type	D (mm)	W (mm)	Tipo Type	D (mm)	W (mm)
20 455 0482	R X-Max	125	06-09	1B9F22100200	Post-Rear	343	A	10,1	20	B	M8 x 1.25	20
20 455 0502	R X-Max	125	10-13	37PF22100000	Post-Rear	343	A	10,1	20	B	M8 x 1.25	20
20 455 0502	Yp R X-Max Abs	125	11	37PF22100000	Post-Rear	343	A	10,1	20	B	M8 x 1.25	20
20 455 0302	Majesty	150	01-02	5D5F2210033	Post-Rear	336	A	10,1	20	B	M8 x 1.25	20
20 455 0302	Majesty	180	03-06	5D5F2210033	Post-Rear	336	A	10,1	20	B	M8 x 1.25	20
20 455 0482	Black X-Max	250	09	1B9F22100200	Post-Rear	343	A	10,1	20	B	M8 x 1.25	20
20 455 0332	Majesty	250	00-03	5GM222100000	Post-Rear	344	A	10,1	20	B	M8 x 1.25	20
20 455 0332	Majesty Abs	250	03	5GM222100000	Post-Rear	344	A	10,1	20	B	M8 x 1.25	20
20 455 0482	R X-Max	250	05-09	1B9F22100200	Post-Rear	343	A	10,1	20	B	M8 x 1.25	20
20 455 0502	R X-Max	250	10-13	37PF22100000	Post-Rear	343	A	10,1	20	B	M8 x 1.25	20
20 455 0802	Vp X-City	250	07-08	5B2F22101000	Post-Rear	358	A	10,1	20	B	M8 x 1.25	20
20 455 0492	Vp X-City	250	09-15	5B2F221020	Post-Rear	358	A	10,1	20	B	M8 x 1.25	20
20 455 0342	Majesty Yp	400	04-11	5RU222101000	Post-Rear	415	B	10 x 1,25	20	B	M8 x 1.25	20
20 455 0342	Majesty Yp Abs	400	07-11	5RU222101000	Post-Rear	415	B	10 x 1,25	20	B	M8 x 1.25	20
20 455 0912	Yp R X-Max	400	13-15	1SDF22101000	Post-Rear	405	A	10,1	20	B	M8 x 1.25	20
20 455 0912	Yp Ra X-Max Abs	400	13-15	1SDF22101000	Post-Rear	405	A	10,1	20	B	M8 x 1.25	20

TIPO DI ATTACCO - TYPE OF FASTENING			
A	B	C	D
			

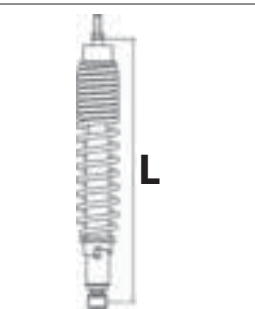
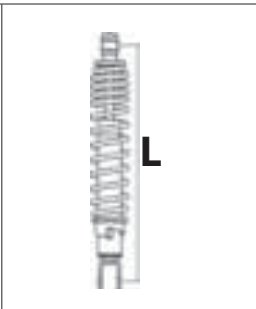
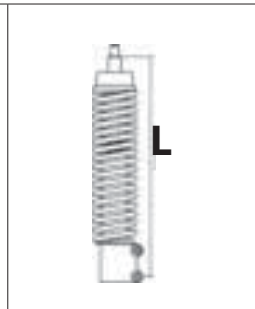
LUNGHEZZA - LENGHT		
		



AMMORTIZZATORI PIAGGIO VESPA 50 CC

50 CC PIAGGIO VESPA SHOCK ABSORBERS

MARCA MODELLO - TRADEMARK MODEL	CODICE - CODE	MARCA MODELLO - TRADEMARK MODEL	CODICE - CODE
PIAGGIO: Vespa 67-82 • Vespa Pk 82-89 (R.O. 1379364)	20 458 4242 	PIAGGIO: Vespa 67-82 • Vespa Pk Automatica 84-89 • Vespa Pk 82-84 (R.O. 1379364)	20 458 5082
PIAGGIO: Vespa 1° serie 67-82 (R.O. 100282)	20 458 4362 	PIAGGIO: Vespa FL 90 • Vespa FL2 Hp 91-97 • Vespa N 89-90 • Vespa Pk XL Rush 88-89 • Vespa Pk 82-84 (R.O. 266584)	20 458 4262
PIAGGIO: Vespa 67-82 • Vespa Pk Automatica 84-89 • Vespa Pk 82-84 (R.O. 610290M)	20 458 5092 	PIAGGIO: Vespa 67-82 • Vespa Pk 82-84 (R.O. 610290M)	20 458 5072
PIAGGIO: Vespa 67-82 • Vespa Pk 82-89 (R.O. 610290M)	20 458 4252 	PIAGGIO: Vespa FL 90 Vespa FL2 Automatica 90-91 Vespa N 89-90 • Vespa Pk XL Rush 88-89 Vespa Pk 82-84	20 458 4302

AMMORTIZZATORI PIAGGIO VESPA 50 CC
50 CC PIAGGIO VESPA SHOCK ABSORBERS



MARCA MODELLO - TRADEMARK MODEL

CODICE - CODE

PIAGGIO: Vespa FL 90 • Vespa FL2 Hp 91-97 •
 Vespa N 89-90 • Vespa Pk 82-89
 (R.O. 2664264)

20 456 0212



PIAGGIO: Vespa 67-82
 (R.O. 58571R)

20 456 0192



PIAGGIO: Vespa 1° serie 67-82
 (R.O. 98812)

20 456 0282



PIAGGIO: Vespa 50 1° serie 67-82

20 455 0292



MARCA MODELLO - TRADEMARK MODEL

CODICE - CODE

PIAGGIO: Vespa 67-82
 (R.O. 2466204)

20 456 0182



PIAGGIO: Vespa FL 90 • Vespa FL2 Hp 91-97 •
 Vespa N 89-90 • Vespa Pk 82-89
 (R.O. 266403)

20 456 0202



PIAGGIO: Vespa 67-82

20 455 0872



PIAGGIO: Vespa FL 90 • Vespa FL2 Hp
 91-97 • Vespa N 89-90 • Vespa Pk XL
 Rush 88-89 • Vespa Pk XL 85-88
 Vespa Pk 82-84

20 455 0382

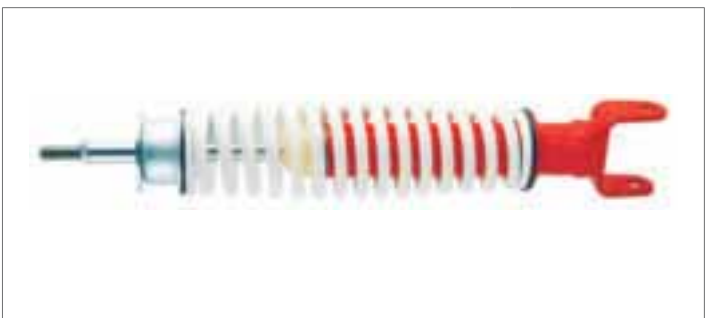



AMMORTIZZATORI PIAGGIO VESPA 50 CC

50 CC PIAGGIO VESPA SHOCK ABSORBERS



CODICE RMS RMS CODE	MODELLO MODEL	ANNI YEARS	RIF ORIGINALE OEM NUMBER	ANT POST FRONT REAR	L (mm)	ATTACCO SUPERIORE UPPER FASTENING POINT			ATTACCO INFERIORE LOWER FASTENING POINT		
						Tipo Type	D (mm)	W (mm)	Tipo Type	D (mm)	W (mm)
20 456 0182	Vespa 50	67-82	246604	Post-Rear	348	C	M9x1,25	16	B	9,6	47
20 455 0872	Vespa 50	67-82	-	Post-Rear	348	C	M9x1,25	16	B	9,6	47
20 456 0192	Vespa 50	67-82	58571R	Post-Rear	344	C	M9x1,25	16	B	9,6	47
20 456 0202	Vespa FL	90-90	266403	Ant-Front	348	C	M8 x 1.0	30	B	9.6	47
20 456 0202	Vespa FL2 Hp	91-97	266403	Ant-Front	348	C	M8 x 1.0	30	B	9.6	47
20 456 0202	Vespa N	89-90	266403	Ant-Front	348	C	M8 x 1.0	30	B	9.6	47
20 456 0202	Vespa Pk	82-84	266403	Ant-Front	348	C	M8 x 1.0	30	B	9.6	47
20 456 0202	Vespa Pk XL	85-88	266403	Ant-Front	348	C	M8 x 1.0	30	B	9.6	47
20 456 0202	Vespa Pk XL Rush	88-89	266403	Ant-Front	348	C	M8 x 1.0	30	B	9.6	47
20 458 5092	Vespa	67-82	610290M	Ant-Front	220	C	M8 x 1.0	14	A	14	40
20 458 5092	Vespa Pk Automatica	84-89	610290M	Ant-Front	220	C	M8 x 1.0	14	A	14	40
20 458 5092	Vespa Pk	82-84	610290M	Ant-Front	220	C	M8 x 1.0	14	A	14	40
20 458 5082	Vespa	67-82	1379364	Ant-Front	220	C	M8 x 1.0	14	A	14	40
20 458 5082	Vespa Pk Automatica	84-89	1379364	Ant-Front	220	C	M8 x 1.0	14	A	14	40
20 458 5082	Vespa Pk	82-84	1379364	Ant-Front	220	C	M8 x 1.0	14	A	14	40
20 456 0212	Vespa FL	90-90	2664264	Post-Rear	344	C	M8 x 1.0	30	B	9.6	47
20 456 0212	Vespa FL2 Hp	91-97	2664264	Post-Rear	344	C	M8 x 1.0	30	B	9.6	47
20 456 0212	Vespa N	89-90	2664264	Post-Rear	344	C	M8 x 1.0	30	B	9.6	47
20 456 0212	Vespa Pk	82-84	2664264	Post-Rear	344	C	M8 x 1.0	30	B	9.6	47
20 456 0212	Vespa Pk XL	85-88	2664264	Post-Rear	344	C	M8 x 1.0	30	B	9.6	47
20 456 0212	Vespa Pk XL Rush	88-89	2664264	Post-Rear	344	C	M8 x 1.0	30	B	9.6	47
20 458 4242	Vespa 125	67-82	1379364	Ant-Front	217	C	M8 x 1.0	25	A	14,1	40
20 458 4242	Vespa Pk	82-84	1379364	Ant-Front	217	C	M8 x 1.0	25	A	14,1	40
20 458 4242	Vespa Pk S Automatica	84-89	1379364	Ant-Front	217	C	M8 x 1.0	25	A	14,1	40
20 458 4252	Vespa 50	67-82	610290	Ant-Front	215	C	M8 x 1.0	30	A	14,1	40
20 458 4252	Vespa Pk	82-84	610290	Ant-Front	215	C	M8 x 1.0	30	A	14,1	40
20 458 4252	Vespa Pk S Automatica	84-89	610290	Ant-Front	215	C	M8 x 1.0	30	A	14,1	40
20 458 4262	Vespa FL	90	266584	Ant-Front	253	C	M10x1,25	17	D	M8x1,25	35
20 458 4262	Vespa FL2 Automatica	90-91	266584	Ant-Front	253	C	M10x1,25	17	D	M8x1,25	35
20 458 4262	Vespa N	89-90	266584	Ant-Front	253	C	M10x1,25	17	D	M8x1,25	35
20 458 4262	Vespa Pk XL Rush	88-89	266584	Ant-Front	253	C	M10x1,25	17	D	M8x1,25	35
20 458 4262	Vespa Pk	82-84	266584	Ant-Front	253	C	M10x1,25	17	D	M8x1,25	35
20 455 0382	Vespa FL	90	-	Post-Rear	353	C	M9x 1,25	24	B	9,6	47
20 455 0382	Vespa FL2 Hp	91-97	-	Post-Rear	353	C	M9x 1,25	24	B	9,6	47
20 455 0382	Vespa N	89-90	-	Post-Rear	353	C	M9x 1,25	24	B	9,6	47
20 455 0382	Vespa Pk XL Rush	88-89	-	Post-Rear	353	C	M9x 1,25	24	B	9,6	47
20 455 0382	Vespa Pk XL	85-88	-	Post-Rear	353	C	M9x 1,25	24	B	9,6	47
20 455 0382	Vespa Pk	82-84	-	Post-Rear	353	C	M9x 1,25	24	B	9,6	47
20 455 0292	Vespa 50	67-82	-	Post-Rear	347	C	M9x 1,25	16	B	9,6	47
20 458 4302	Vespa FL	90	-	Ant-Front	253	C	M10x1,25	17	D	M8x1,25	35
20 458 4302	Vespa FL2 Automatica	90-91	-	Ant-Front	253	C	M10x1,25	17	D	M8x1,25	35
20 458 4302	Vespa N	89-90	-	Ant-Front	253	C	M10x1,25	17	D	M8x1,25	35

AMMORTIZZATORI PIAGGIO VESPA 50 CC

50 CC PIAGGIO VESPA SHOCK ABSORBERS

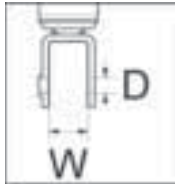

CODICE RMS RMS CODE	MODELLO MODEL	ANNI YEARS	RIF ORIGINALE OEM NUMBER	ANT POST FRONT REAR	L (mm)	ATTACCO SUPERIORE UPPER FASTENING POINT			ATTACCO INFERIORE LOWER FASTENING POINT		
						Tipo Type	D (mm)	W (mm)	Tipo Type	D (mm)	W (mm)
20 458 4302	Vespa Pk XL Rush	88-89	-	Ant-Front	253	C	M10x1,25	17	D	M8x1,25	35
20 458 4302	Vespa Pk	82-84	-	Ant-Front	253	C	M10x1,25	17	D	M8x1,25	35
20 458 4362	Vespa 50	67-82	100282	Ant-Front	214	C	M8x1,0	16	A	14,1	40
20 456 0282	Vespa 50	67-82	98812	Ant-Front	344	C	M9x1,25	16	B	9,6	47
20 458 5072	Vespa 50	67-82	610290	Ant-Front	217	C	M8x1,0	16	A	14,1	40
20 458 5072	Vespa Pk	82-84	610290	Ant-Front	217	C	M8x1,0	16	A	14,1	40

TIPO DI ATTACCO - TYPE OF FASTENING			
A	B	C	D
			

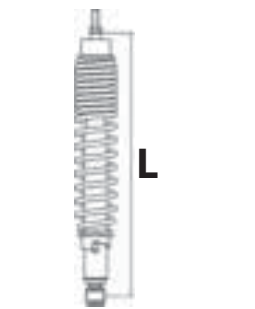
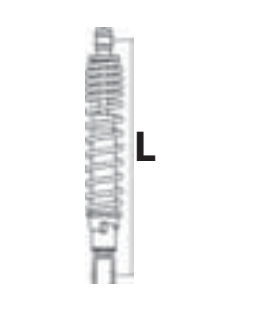
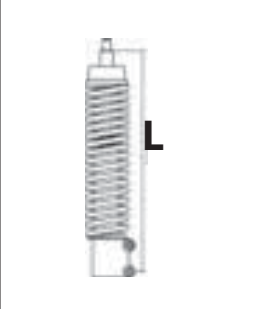
LUNGHEZZA - LENGHT		
		



AMMORTIZZATORI PIAGGIO VESPA OLTRE 50 CC

OVER 50 CC PIAGGIO VESPA SHOCK ABSORBERS

MARCA MODELLO - TRADEMARK MODEL	CODICE - CODE	MARCA MODELLO - TRADEMARK MODEL	CODICE - CODE
PIAGGIO 125-150: Vespa Super • Vespa GL • Vespa Sprint (R.O. 1375714)	20 458 4272 	PIAGGIO 125-150: Vespa Super • Vespa GL • Vespa Sprint (R.O. 13757140001)	20 458 5062
PIAGGIO 125: Vespa 67-82 (R.O. 1379364)	20 458 4242 	PIAGGIO 125: Vespa 67-82 (R.O. 1379364)	20 458 5082
PIAGGIO 125-150: Vespa Px 200: Vespa Pe (R.O. 2329284)	 20 458 4392 	PIAGGIO 125: Vespa FL 89-90 Vespa Pk XL 86-89 (R.O. 266584)	20 458 4262
PIAGGIO 125: Vespa Px T5 85-89 Vespa Pxe Arcobaleno 81-97 150-200: Vespa Pxe Arcobaleno 81-97 (R.O. 2329284)	20 458 4402 	PIAGGIO 125-150-200: Vespa Px (R.O. 56187R)	20 458 5052
PIAGGIO 125: Vespa Px 30 Anni 07-08 Vespa Px Eu2 01-07 • Vespa Px 98-01 Vespa Px 11-13 • 150: Vespa Px 11-15 (R.O. 56187R)	20 458 4332 	PIAGGIO 125-150-200: Cosa CL 88-91 Cosa CLX 88-91 • Cosa 2 91-97 (R.O. 2679244)	20 458 5102

AMMORTIZZATORI PIAGGIO VESPA OLTRE 50 CC
OVER 50 CC PIAGGIO VESPA SHOCK ABSORBERS



MARCA MODELLO - TRADEMARK MODEL

CODICE - CODE

PIAGGIO 125-150-200: Vespa Px

20 458 4312



MARCA MODELLO - TRADEMARK MODEL

CODICE - CODE

PIAGGIO 125-150-200: Vespa Px freno a disco

20 458 4342



PIAGGIO 125-150-200: Vespa Px

20 458 4292



PIAGGIO 125: Vespa FL 89-90
Vespa Pk XL 86-89

20 458 4302

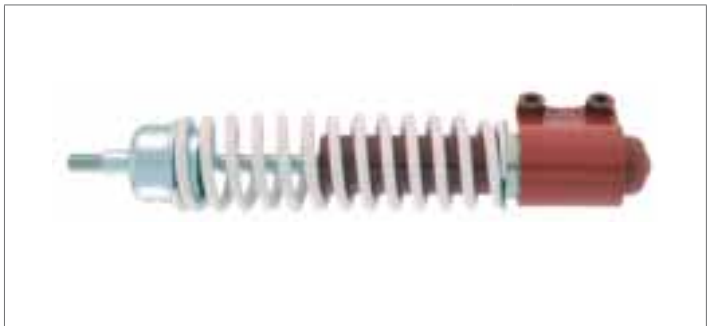

PIAGGIO 125: Vespa 67-82
(R.O. 610290M)

20 458 5092



PIAGGIO 125: Vespa 67-82
(R.O. 610290)

20 458 5072



PIAGGIO 125: Vespa 67-82
(R.O. 610290)

20 458 4252





AMMORTIZZATORI PIAGGIO VESPA OLTRE 50 CC OVER 50 CC PIAGGIO VESPA SHOCK ABSORBERS

MARCA MODELLO - TRADEMARK MODEL	CODICE - CODE	MARCA MODELLO - TRADEMARK MODEL	CODICE - CODE
PIAGGIO 125-150: Vespa Vna - Vnb 58-66	20 456 0242 	PIAGGIO 125: Vespa Px 98-07 • Vespa PX T5 85-89 • Vespa Px E Arcobaleno (R.O. 58571R)	20 456 0192
PIAGGIO 125: Vespa PX T5 85-89 • Vespa Px E Arcobaleno (R.O. 2466204)	20 456 0182 	PIAGGIO 125: Vespa Px freno a disco • Vespa FL 89-90 • Vespa Pk XL 86-89 • Vespa Px 30 anni 07-08 • Vespa Px Eu2 01-07 • Vespa Px 11-13 • Vespa Px e Arcobaleno 81-97 - 150: Vespa Px 11-13 • Vespa Px freno a disco - 200: Vespa Px freno a disco (R.O. 561882)	20 456 0272
PIAGGIO 125-150-200: Cosa CL 88-91 CLX 88-91 • Cosa 2 91-97 (R.O. 2681414)	20 455 0892 	PIAGGIO 90: Vespa 67-82 125: Vespa 67-82 • Vespa Primavera Vespa Et3 • Vespa Sprint • Vespa Super Vespa Ts • Vespa Px • 150: Vespa Sprint • Vespa Super • Vespa Px • 200: Vespa Px • Vespa Rally	20 455 0872
PIAGGIO 125: Vespa Special • Vespa Et3 Primavera • Vespa Sprint • Vespa T5 85/89 • Vespa Px - 150: Vespa Px • 200: Vespa Px • Vespa Rally (R.O. 494783)	20 455 0292 	PIAGGIO 125: Vespa Px freno a disco • Vespa Px 30 anni 07-08 • Vespa Px Eu2 01-07 • Vespa Px 11-13 • Vespa Px e Arcobaleno 81-97 - 150: Vespa Px 11-13 • Vespa Px freno a disco - 200: Vespa Px freno a disco (R.O. 561882)	20 455 0412
PIAGGIO 125: Vespa FL 89-90 • Vespa Pk XL 86-89	20 455 0382 		

AMMORTIZZATORI INNOCENTI LAMBRETТА

INNOCENTI LAMBRETТА SHOCK ABSORBERS



MARCA MODELLO - TRADEMARK MODEL

INNOCENTI 125-150-200:

Lambretta Li 2° Serie
(R.O. 19058120)

CODICE - CODE

20 456 0262



MARCA MODELLO - TRADEMARK MODEL

INNOCENTI 125-150-175-200:

Lambretta Li 3° Serie
(R.O. 19058100)

CODICE - CODE

20 456 0252



INNOCENTI 125-150-175-200:

Lambretta Li 3° Serie
Zincato - Galvanized
(R.O. 19058100)

20 456 0292



CODICE RMS RMS CODE	MODELLO MODEL	CC	ANNI YEARS	RIF ORIGINALE OEM NUMBER	ANT POST FRONT REAR	L (mm)	ATTACCO SUPERIORE UPPER FASTENING POINT			ATTACCO INFERIORE LOWER FASTENING POINT		
							Tipo Type	D (mm)	W (mm)	Tipo Type	D (mm)	W (mm)
INNOCENTI												
20 456 0262	Lambretta Li 2° Serie	125	-	19058120	Post-Rear	317	A	18	33	A	18	33
20 456 0262	Lambretta Li 2° Serie	150	-	19058120	Post-Rear	317	A	18	33	A	18	33
20 456 0262	Lambretta Li 2° Serie	200	-	19058120	Post-Rear	317	A	18	33	A	18	33
20 456 0252	Lambretta Li 3° Serie	125	-	19058120	Post-Rear	305	A	18	33	A	18	33
20 456 0292	Lambretta Li 3° Serie	125	-	19058120	Post-Rear	305	A	18	33	A	18	33
20 456 0252	Lambretta Li 3° Serie	150	-	19058120	Post-Rear	305	A	18	33	A	18	33
20 456 0292	Lambretta Li 3° Serie	150	-	19058120	Post-Rear	305	A	18	33	A	18	33
20 456 0252	Lambretta Li 3° Serie	175	-	19058120	Post-Rear	305	A	18	33	A	18	33
20 456 0292	Lambretta Li 3° Serie	175	-	19058120	-	305	A	18	33	A	18	33
20 456 0252	Lambretta Li 3° Serie	200	-	19058120	-	305	A	18	33	A	18	33
20 456 0292	Lambretta Li 3° Serie	200	-	19058120	-	305	A	18	33	A	18	33



AMMORTIZZATORI PIAGGIO VESPA OLTRE 50 CC OVER 50 CC PIAGGIO VESPA SHOCK ABSORBERS

CODICE RMS RMS CODE	MODELLO MODEL	CC	ANNI YEARS	RIF ORIGINALE OEM NUMBER	ANT POST FRONT REAR	L (mm)	ATTACCO SUPERIORE UPPER FASTENING POINT			ATTACCO INFERIORE LOWER FASTENING POINT		
							Tipo Type	D (mm)	W (mm)	Tipo Type	D (mm)	W (mm)
20 455 0872	Vespa	90	67-82	-	Post-Rear	344	C	M9 x1,25	16	B	9,6	47
20 456 0182	Vespa Px	125	98-01	2466204	Post-Rear	348	C	M9 x 1.25	16	B	9.6	47
20 456 0192	Vespa Px	125	98-01	58571R	Post-Rear	344	C	M9 x 1.25	16	B	9.6	47
20 456 0182	Vespa Px 30 Anni	125	07-08	2466204	Post-Rear	348	C	M9 x 1.25	16	B	9.6	47
20 456 0192	Vespa Px 30 Anni	125	07-08	58571R	Post-Rear	344	C	M9 x 1.25	16	B	9.6	47
20 456 0182	Vespa Px Eu2	125	01-07	2466204	Post-Rear	348	C	M9 x 1.25	16	B	9.6	47
20 456 0192	Vespa Px Eu2	125	01-07	58571R	Post-Rear	344	C	M9 x 1.25	16	B	9.6	47
20 456 0182	Vespa Px T5	125	85-89	2466204	Post-Rear	348	C	M9 x 1.25	16	B	9.6	47
20 456 0192	Vespa Px T5	125	85-89	58571R	Post-Rear	344	C	M9 x 1.25	16	B	9.6	47
20 458 4292	Vespa Px	125			Ant-Front	310	C	M10 x 1.25	14	D	8,1	38
20 458 4402	Vespa Px T5	125	85-89	2329284	Ant-Front	310	C	M10 x 1.25	14	D	8,1	38
20 458 4402	Vespa Pxe Arcobaleno	125	81-97	2329284	Ant-Front	310	C	M10 x 1.25	14	D	8,1	38
20 458 4332	Vespa Px 30 anni	125	07-08	56187R	Ant-Front	310	C	M10 x 1.25	14	D	8,1	38
20 458 4332	Vespa Px Eu2	125	01-07	56187R	Ant-Front	310	C	M10 x 1.25	14	D	8,1	38
20 458 4332	Vespa Px	125	98-13	56187R	Ant-Front	310	C	M10 x 1.25	14	D	8,1	38
20 456 0182	Vespa Pxe Arcobaleno	125	81-97	2466204	Post-Rear	348	C	M9 x 1.25	16	B	9.6	47
20 458 5082	Vespa	125	67-82	1379364	Ant-Front	220	C	M8 x 1.0	14	A	14	40
20 458 5092	Vespa	125	67-82	610290M	Ant-Front	220	C	M8 x 1.0	14	A	14	40
20 458 5072	Vespa	125	67-82	610290M	Ant-Front	220	C	M8 x 1.0	14	A	14	40
20 458 4252	Vespa	125	67-82	610290M	Ant-Front	220	C	M8 x 1.0	14	A	14	40
20 456 0192	Vespa Pxe Arcobaleno	125	81-97	58571R	Post-Rear	344	C	M9 x 1.25	16	B	9.6	47
20 455 0292	Vespa Special	125		494783	Post-Rear	347	C	M9x1,25	16	B	9,6	47
20 455 0292	Vespa Et3 Primavera	125		494783	Post-Rear	347	C	M9x1,25	16	B	9,6	47
20 455 0292	Vespa Sprint	125		494783	Post-Rear	347	C	M9x1,25	16	B	9,6	47
20 455 0292	Vespa T5	125	85-89	494783	Post-Rear	347	C	M9x1,25	16	B	9,6	47
20 455 0292	Vespa Px	125		494783	Post-Rear	347	C	M9x1,25	16	B	9,6	47
20 455 0872	Vespa	125	67-82	-	Post-Rear	344	C	M9 x1,25	16	B	9,6	47
20 455 0872	Vespa Primavera	125		-	Post-Rear	344	C	M9 x1,25	16	B	9,6	47
20 455 0872	Vespa Et3	125		-	Post-Rear	344	C	M9 x1,25	16	B	9,6	47
20 455 0872	Vespa Sprint	125		-	Post-Rear	344	C	M9 x1,25	16	B	9,6	47
20 455 0872	Vespa Super	125		-	Post-Rear	344	C	M9 x1,25	16	B	9,6	47
20 455 0872	Vespa Ts	125		-	Post-Rear	344	C	M9 x1,25	16	B	9,6	47
20 455 0872	Vespa Px	125		-	Post-Rear	344	C	M9 x1,25	16	B	9,6	47
20 455 0412	Vespa Px Freno A Disco	125		561882	Post-Rear	391	C	M9x1,25	16	B	9,6	47
20 455 0412	Vespa Px 30 anni	125	07-08	561882	Post-Rear	391	C	M9x1,25	16	B	9,6	47
20 455 0412	Vespa Px Eu2	125	01-07	561882	Post-Rear	391	C	M9x1,25	16	B	9,6	47
20 455 0412	Vespa Px T5	125	85-89	561882	Post-Rear	391	C	M9x1,25	16	B	9,6	47
20 455 0412	Vespa Px	125	11-13	561882	Post-Rear	391	C	M9x1,25	16	B	9,6	47
20 455 0412	Vespa Px E Arcobaleno	125	81-97	561882	Post-Rear	391	C	M9x1,25	16	B	9,6	47
20 456 0242	Vespa Vna	125	58-66		Post-Rear	355	C	M9x1,25	16	B	9,2	45
20 456 0242	Vespa Vnb	125	58-66		Post-Rear	355	C	M9x1,25	16	B	9,2	45
20 456 0272	Vespa FL	125	89-90	561882	Post-Rear	391	C	M9x1,25	16	B	9,6	47
20 456 0272	Vespa Pk XL	125	86-89	561882	Post-Rear	391	C	M9x1,25	16	B	9,6	47
20 456 0272	Vespa Px 30 anni	125	07-08	561882	Post-Rear	391	C	M9x1,25	16	B	9,6	47
20 456 0272	Vespa Px Eu2	125	01-07	561882	Post-Rear	391	C	M9x1,25	16	B	9,6	47
20 456 0272	Vespa Px T5	125	85-89	561882	Post-Rear	391	C	M9x1,25	16	B	9,6	47
20 456 0272	Vespa Px	125	11-13	561882	Post-Rear	391	C	M9x1,25	16	B	9,6	47
20 456 0272	Vespa Px E Arcobaleno	125	81-97	561882	Post-Rear	391	C	M9x1,25	16	B	9,6	47
20 456 0272	Vespa Px Freno A Disco	125		561882	Post-Rear	391	C	M9x1,25	16	B	9,6	47

AMMORTIZZATORI PIAGGIO VESPA OLTRE 50 CC

OVER 50 CC PIAGGIO VESPA SHOCK ABSORBERS





CODICE RMS RMS CODE	MODELLO MODEL	CC	ANNI YEARS	RIF ORIGINALE OEM NUMBER	ANT POST FRONT REAR	L (mm)	ATTACCO SUPERIORE UPPER FASTENING POINT			ATTACCO INFERIORE LOWER FASTENING POINT		
							Tipo Type	D (mm)	W (mm)	Tipo Type	D (mm)	W (mm)
20 458 4262	Vespa Pk XL	125	86-89	2665384	Ant-Front	253	C	M10x1,25	17	D	M8x1,25	35
20 458 4262	Vespa FL	125	89-90	2665384	Ant-Front	253	C	M10x1,25	17	D	M8x1,25	35
20 458 4272	Vespa Super	125		1375714	Ant-Front	212	A	11,2	20	A	11,2	26
20 458 4272	Vespa GL	125		1375714	Ant-Front	212	A	11,2	20	A	11,2	26
20 458 4272	Vespa Sprint	125		1375714	Ant-Front	212	A	11,2	20	A	11,2	26
20 458 5062	Vespa Super(Zinc.)	125		1375714	Ant-Front	212	A	11,2	20	A	11,2	26
20 458 5062	Vespa GL (Zinc.)	125		1375714	Ant-Front	212	A	11,2	20	A	11,2	26
20 458 5062	Vespa Sprint (Zinc.)	125		1375714	Ant-Front	212	A	11,2	20	A	11,2	26
20 458 5072	Vespa Vespa Primavera Et3	125	-	-	Ant-Front	229	C	M8 x 1.0	16	A	14,1	40
20 458 4282	Vespa Px	125		2329284	Ant-Front	310	C	M10x1,25	14	D	8,1	38
20 458 4312	Vespa Px	125			Ant-Front	310	C	M10x1,25	14	D	8,1	38
20 458 4342	Vespa Px Freno A Disco	125			Ant-Front	310	C	M10x1,25	14	D	M8x1,25	38
20 458 5072	Vespa Et3 Primavera	125		610290M	Ant-Front	229	C	M8x1,0	16	A	14,1	40
20 455 0892	Cosa CL - CLX	125	88-91	2681414	Post-Rear	453	C	M9x1,25	22	B	10	50
20 458 5102	Cosa CL - CLX	125	88-91	2679244	Ant-Front	312	C	M10x1,25	12	D	8	38
20 455 0892	Cosa 2	125	91-97	2681414	Post-Rear	453	C	M9x1,25	22	B	10	50
20 458 5102	Cosa 2	125	91-97	2679244	Ant-Front	312	C	M10x1,25	12	D	8	38
20 456 0192	Vespa Px	150	01-12	58571R	Post-Rear	344	C	M9 x 1.25	16	B	9,6	47
20 455 0292	Vespa Px	150		494783	Post-Rear	347	C	M9x1,25	16	B	9,6	47
20 455 0412	Vespa Px Freno A Disco	150		561882	Post-Rear	391	C	M9x1,25	16	B	9,6	47
20 455 0412	Vespa Px	150	11-13	561882	Post-Rear	391	C	M9x1,25	16	B	9,6	47
20 456 0242	Vespa Vna	150	58-66		Post-Rear	355	C	M9x1,25	16	B	9,2	45
20 456 0242	Vespa Vnb	150	58-66		Post-Rear	355	C	M9x1,25	16	B	9,2	45
20 456 0272	Vespa Px Freno A Disco	150		561882	Post-Rear	391	C	M9x1,25	16	B	9,6	47
20 456 0272	Vespa Px	150	11-13	561882	Post-Rear	391	C	M9x1,25	16	B	9,6	47
20 458 4272	Vespa Super	150		1375714	Ant-Front	212	A	11,2	20	A	11,2	26
20 458 4272	Vespa GL	150		1375714	Ant-Front	212	A	11,2	20	A	11,2	26
20 458 4272	Vespa Sprint	150		1375714	Ant-Front	212	A	11,2	20	A	11,2	26
20 458 5062	Vespa Super (Zinc.)	150		1375714	Ant-Front	212	A	11,2	20	A	11,2	26
20 458 5062	Vespa GL (Zinc.)	150		1375714	Ant-Front	212	A	11,2	20	A	11,2	26
20 458 5062	Vespa Sprint (Zinc.)	150		1375714	Ant-Front	212	A	11,2	20	A	11,2	26
20 458 4332	Vespa Px	150	11-15	56187R	Ant-Front	310	C	M10 x 1.25	14	D	8,1	38
20 458 4282	Vespa Px	150		2329284	Ant-Front	310	C	M10x1,25	14	D	8,1	38
20 458 4312	Vespa Px	150			Ant-Front	310	C	M10x1,25	14	D	8,1	38
20 458 4342	Vespa Px Freno A Disco	150			Ant-Front	310	C	M10x1,25	14	D	M8x1,25	38
20 455 0872	Vespa Sprint	150		-	Post-Rear	344	C	M9 x 1,25	16	B	9,6	47
20 455 0872	Vespa Super	150		-	Post-Rear	344	C	M9 x 1,25	16	B	9,6	47
20 455 0872	Vespa Px	150		-	Post-Rear	344	C	M9 x 1,25	16	B	9,6	47
20 458 4292	Vespa Px	150			Ant-Front	310	C	M10 x 1.25	14	D	8,1	38
20 458 4402	Vespa Pxe Arcobaleno	150	81-97	2329284	Ant-Front	310	C	M10 x 1.25	14	D	8,1	38
20 455 0892	Cosa CL - CLX	150	88-91	2681414	Post-Rear	453	C	M9x1,25	22	B	10	50
20 458 5102	Cosa CL - CLX	150	88-91	2679244	Ant-Front	312	C	M10x1,25	12	D	8	38
20 455 0892	Cosa 2	150	91-97	2681414	Post-Rear	453	C	M9x1,25	22	B	10	50
20 458 5102	Cosa 2	150	91-97	2679244	Ant-Front	312	C	M10x1,25	12	D	8	38
20 455 0292	Vespa Rally	200		494783	Post-Rear	347	C	M9x1,25	16	B	9,6	47
20 455 0412	Vespa Px Freno A Disco	200		561882	Post-Rear	391	C	M9x1,25	16	B	9,6	47
20 456 0272	Vespa Px Freno A Disco	200		561882	Post-Rear	391	C	M9x1,25	16	B	9,6	47
20 458 4282	Vespa Pe	200		2329284	Ant-Front	310	C	M10x1,25	14	D	8,1	38

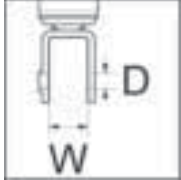

AMMORTIZZATORI PIAGGIO VESPA OLTRE 50 CC OVER 50 CC PIAGGIO VESPA SHOCK ABSORBERS

CODICE RMS RMS CODE	MODELLO MODEL	CC	ANNI YEARS	RIF ORIGINALE OEM NUMBER	ANT POST FRONT REAR	L (mm)	ATTACCO SUPERIORE UPPER FASTENING POINT			ATTACCO INFERIORE LOWER FASTENING POINT		
							Tipo Type	D (mm)	W (mm)	Tipo Type	D (mm)	W (mm)
20 458 4312	Vespa Px	200			Ant-Front	310	C	M10x1,25	14	D	8,1	38
20 458 4342	Vespa Px Freno A Disco	200			Ant-Front	310	C	M10x1,25	14	D	M8x1,25	38
20 455 0872	Vespa Px	200		-	Post-Rear	344	C	M9 x1,25	16	B	9,6	47
20 458 4292	Vespa Px	200			Ant-Front	310	C	M10 x 1.25	14	D	8,1	38
20 458 4402	Vespa Pxe Arcobaleno	200	81-97	2329284	Ant-Front	310	C	M10 x 1.25	14	D	8,1	38
20 455 0872	Vespa Rally	200		-	Post-Rear	344	C	M9 x1,25	16	B	9,6	47
20 455 0892	Cosa CL - CLX	200	88-91	2681414	Post-Rear	453	C	M9x1,25	22	B	10	50
20 458 5102	Cosa CL - CLX	200	88-91	2679244	Ant-Front	312	C	M10x1,25	12	D	8	38
20 455 0892	Cosa 2	200	91-97	2681414	Post-Rear	453	C	M9x1,25	22	B	10	50
20 458 5102	Cosa 2	200	91-97	2679244	Ant-Front	312	C	M10x1,25	12	D	8	38

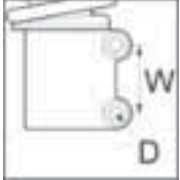
TIPO DI ATTACCO - TYPE OF FASTENING			
A	B	C	D
			

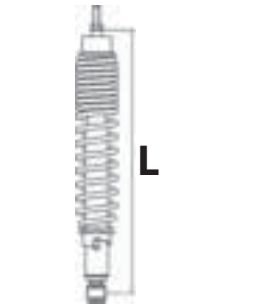
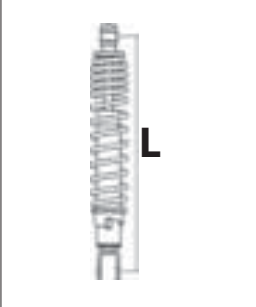
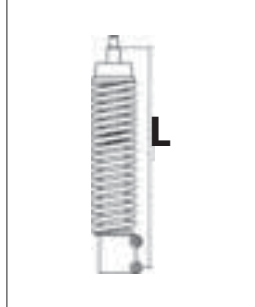
LUNGHEZZA - LENGHT		
		

AMMORTIZZATORI REGOLABILI IN ALLUMINIO
ALUMINIUM ADJUSTABLE SHOCK ABSORBERS



MARCA MODELLO - TRADEMARK MODEL	CODICE - CODE	MARCA MODELLO - TRADEMARK MODEL	CODICE - CODE
APRILIA 125-300: Sr Max (R.O. 647524)	20 455 0753 	APRILIA 300: Sport City (R.O. AP8164551)	20 455 0463
HONDA 125-150: Sh <13 (R.O. 52400-KTF-641)	20 455 0313 	HONDA 125-150: Sh 13> (R.O. 52400-K01-901)	20 455 0723
HONDA 300: Sh 07> (R.O. 52400-KTW-903)	20 455 0703 	KYMCO 125-150-200: Agility R16 (R.O. 00152274)	20 455 0523
KYMCO 125-300: Downtown (R.O. 00152254)	20 455 0533 	KYMCO 125-300: K-Xct 12> (R.O. 00152380NI)	20 455 0763
PIAGGIO 125-250-300: Beverly • Tourer Rst (R.O. 601014)	20 455 0683 	PIAGGIO 350: Beverly 07> (R.O. 58583R)	20 455 0633
PIAGGIO 400-500: Beverly / Tourer - Cruiser (R.O. 56210R)	20 455 0653 	PIAGGIO 125: Vespa Px (R.O. 2329284)	20 458 5043



AMMORTIZZATORI REGOLABILI IN ALLUMINIO

ALUMINIUM ADJUSTABLE SHOCK ABSORBERS

MARCA MODELLO - TRADEMARK MODEL	CODICE - CODE	MARCA MODELLO - TRADEMARK MODEL	CODICE - CODE
PIAGGIO 125: Vespa Px (R.O. 58571R)	20 456 0193 	PIAGGIO 125-200-250-300: Vespa Gts • Gtv (R.O. 56286R)	20 458 4383
PIAGGIO 125-200-250-300: Vespa Gts • Gtv (R.O. 58503R)	20 455 0513 	PIAGGIO 125-150: Vespa Lx • Touring (R.O. 646959)	20 458 4373
PIAGGIO 125-150: Vespa Lx • Touring (R.O. 56230R)	20 455 0433 	PIAGGIO 125: Beverly Rst 10-13 300: Beverly Rst 10-13 (R.O. 58518R)	20 455 0663
YAMAHA 125-250: X-Max 10-12 (R.O. 37PF22100000)	20 455 0503 	YAMAHA 400: Majesty 04> (R.O. 5RU222103000)	20 455 0343
YAMAHA 250: Vp X City 06-12 (R.O. 5B2F221020)	20 455 0493 		

AMMORTIZZATORI REGOLABILI IN ALLUMINIO
ALUMINIUM ADJUSTABLE SHOCK ABSORBERS



CODICE RMS RMS CODE	MODELLO MODEL	CC	ANNI YEARS	RIF ORIGINALE OEM NUMBER	ANT POST FRONT REAR	CODICE RMS RMS CODE	MODELLO MODEL	CC	ANNI YEARS	RIF ORIGINALE OEM NUMBER	ANT POST FRONT REAR
APRILIA						20 455 0513	Vespa Granturismo	125	03-07	58503R	Post-Rear
20 455 0463	Sport City	125	04-06	AP8164551	Post-Rear	20 458 4383	Vespa Granturismo	125	03-07	56286R	Ant-Front
20 455 0463	Sport City Cube	125	08-10	AP8164551	Post-Rear	20 455 0513	Vespa Granturismo Eu3	125	06-07	58503R	Post-Rear
20 455 0463	Sport City Eu3	125	06-08	AP8164551	Post-Rear	20 458 4383	Vespa Granturismo Eu3	125	06-07	56286R	Ant-Front
20 455 0753	Sr Max	125	11	647524	Post-Rear	20 455 0513	Vespa Gts 4t ie Super	125	09-13	58503R	Post-Rear
20 455 0463	Sport City Cube	200	08-10	AP8164551	Post-Rear	20 455 0513	Vespa Gts Eu3	125	07-12	58503R	Post-Rear
20 455 0463	Scarabeo Light	250	06-08	AP8164551	Post-Rear	20 458 4383	Vespa Gts Eu3	125	07-12	56286R	Ant-Front
20 455 0463	Scarabeo Light	300	09-10	AP8164551	Post-Rear	20 458 4383	Vespa Gtv	125	07-08	56286R	Ant-Front
20 455 0463	Sport City Street	300	12	AP8164551	Post-Rear	20 458 4383	Vespa Gtv 4t Navy Eu3	125	08	56286R	Ant-Front
20 455 0753	Sr Max	300	11-12	647524	Post-Rear	20 455 0433	Vespa Lx	125	05-06	56230R	Post-Rear
GILERA						20 458 4373	Vespa Lx	125	05-06	646959	Ant-Front
20 455 0753	Nexus Eu3	125	07-08	647524	Post-Rear	20 455 0433	Vespa Lx 3v ie-Touring	125	12-13	56230R	Post-Rear
20 455 0753	Nexus Eu3 le	125	09-10	647524	Post-Rear	20 458 4373	Vespa Lx 3v ie-Touring	125	12-13	646959	Ant-Front
20 455 0753	Nexus Eu3	250	06	647524	Post-Rear	20 455 0433	Vespa Lx 4t Eu3 Touring	125	10-11	56230R	Post-Rear
20 455 0753	Nexus Sp Eu3	250	06-07	647524	Post-Rear	20 458 4373	Vespa Lx 4t Eu3 Touring	125	10-11	646959	Ant-Front
20 455 0753	Nexus Eu3	300	08-11	647524	Post-Rear	20 455 0433	Vespa Lx 4t FL	125	09	56230R	Post-Rear
HONDA						20 458 4373	Vespa Lx 4t FL	125	09	646959	Ant-Front
20 455 0313	Dylan	125	01-06	52400KTF641	Post-Rear	20 455 0433	Vespa Lx Eu3	125	06-08	56230R	Post-Rear
20 455 0313	Nes	125	00-06	52400KTF641	Post-Rear	20 455 0433	Vespa Lx Eu3 ie	125	09-10	56230R	Post-Rear
20 455 0313	Sh 125	125	01-04	52400KTF641	Post-Rear	20 455 0433	Vespa Lxv 4t Eu3	125	06-09	56230R	Post-Rear
20 455 0313	Sh 125i	125	05-12	52400KTF641	Post-Rear	20 455 0433	Vespa Lxv 4t Navy Eu3	125	08	56230R	Post-Rear
20 455 0723	Sh 125i	125	13	52400-K01-901	Post-Rear	20 455 0433	Vespa Lxv ie 4t	125	10-12	56230R	Post-Rear
20 455 0313	Dylan	150	01-06	52400KTF641	Post-Rear	20 456 0193	Vespa Pk XL	125	86-89	58571R	Post-Rear
20 455 0313	Nes	150	00-06	52400KTF641	Post-Rear	20 456 0193	Vespa Px	125	98-01	58571R	Post-Rear
20 455 0313	Sh 150	150	01-04	52400KTF641	Post-Rear	20 456 0193	Vespa Px 30 Anni	125	07-08	58571R	Post-Rear
20 455 0313	Sh 150i	150	05-12	52400KTF641	Post-Rear	20 456 0193	Vespa Px Eu2	125	01-07	58571R	Post-Rear
20 455 0723	Sh 150i	150	13	52400-K01-901	Post-Rear	20 456 0193	Vespa Px T5	125	85-89	58571R	Post-Rear
20 455 0703	Forza	250	05-07	52400-KTW-903	Post-Rear	20 456 0193	Vespa Pxe Arcobaleno	125	81-97	58571R	Post-Rear
20 455 0703	Jazz	250	01-05	52400-KTW-903	Post-Rear	20 455 0433	Zip	125	00-02	56230R	Post-Rear
20 455 0703	Sh 300	300	07-13	52400-KTW-903	Post-Rear	20 455 0433	Vespa Lx	150	05-06	56230R	Post-Rear
KYMCO						20 458 4373	Vespa Lx	150	05-06	646959	Ant-Front
20 455 0523	Agility R16	125	08-12	00152274	Post-Rear	20 455 0433	Vespa Lx 3v ie-Touring	150	12-13	56230R	Post-Rear
20 455 0763	K-Xct I	125	12	00152380N1	Post-Rear	20 458 4373	Vespa Lx 3v ie-Touring	150	12-13	646959	Ant-Front
20 455 0523	Agility R16	150	08-09	00152274	Post-Rear	20 455 0433	Vespa Lx 4t FL	150	09	56230R	Post-Rear
20 455 0523	Agility 200 R16	200	10-12	00152274	Post-Rear	20 458 4373	Vespa Lx 4t FL	150	09	646959	Ant-Front
20 455 0533	Downtown i	200	10	00152254	Post-Rear	20 455 0433	Vespa Lx Eu3	150	06-08	56230R	Post-Rear
20 455 0533	Downtown 300i	300	09-11	00152254	Post-Rear	20 455 0433	Vespa Lx Eu3 ie	150	09-11	56230R	Post-Rear
20 455 0763	K-Xct I	300	12	00152380N1	Post-Rear	20 458 4373	Vespa Lx Eu3 ie	150	09-11	646959	Ant-Front
PIAGGIO						20 455 0433	Vespa Lx Touring	150	10-12	56230R	Post-Rear
20 455 0683	Beverly	125	01-03	601014	Post-Rear	20 458 4373	Vespa Lx Touring	150	10-12	646959	Ant-Front
20 455 0683	Beverly Eu3	125	07-08	601014	Post-Rear	20 456 0193	Vespa Px	150	01-12	58571R	Post-Rear
20 455 0683	Beverly Eu3 Mic	125	07-08	601014	Post-Rear	20 455 0513	Vespa Granturismo	200	06-07	58503R	Post-Rear
20 455 0683	Beverly Eu3 Sport	125	07-08	601014	Post-Rear	20 458 4383	Vespa Granturismo	200	06-07	56286R	Ant-Front
20 455 0683	Beverly Rst	125	04-07	601014	Post-Rear	20 455 0683	Beverly	250	06-07	601014	Post-Rear
20 455 0663	Beverly Rst 4t 4v ie Eu3	125	10-13	58518R	Post-Rear	20 455 0683	Beverly Cruiser	250	07-09	601014	Post-Rear
20 455 0683	Beverly Rst 4t 4v ie Eu3	125	10-11	601014	Post-Rear	20 455 0683	Beverly Eu3 Mic	250	07	601014	Post-Rear
20 455 0683	Beverly Tourer Eu3	125	08-10	601014	Post-Rear	20 455 0683	Beverly ie Eu3	250	06-08	601014	Post-Rear
20 455 0433	Skipper 4t	125	00-02	56230R	Post-Rear	20 455 0683	Beverly Rst	250	04-05	601014	Post-Rear
20 455 0433	Vespa Et4	125	99-02	56230R	Post-Rear	20 455 0683	Beverly Tourer Eu3	250	08-09	601014	Post-Rear
20 456 0193	Vespa FL	125	89-90	58571R	Post-Rear	20 455 0513	Vespa Gt 60 Eu3	250	06-07	58503R	Post-Rear



AMMORTIZZATORI REGOLABILI IN ALLUMINIO

ALUMINIUM ADJUSTABLE SHOCK ABSORBERS

CODICE RMS <i>RMS CODE</i>	MODELLO <i>MODEL</i>	CC	ANNI <i>YEARS</i>	RIF ORIGINALE <i>OEM</i> NUMBER	ANT POST FRONT REAR	CODICE RMS <i>RMS CODE</i>	MODELLO <i>MODEL</i>	CC	ANNI <i>YEARS</i>	RIF ORIGINALE <i>OEM</i> NUMBER	ANT POST FRONT REAR
20 458 4383	Vespa Gt 60 Eu3	250	06-07	56286R	Ant-Front	20 455 0633	Beverly 4t 4v ie Sport	350	11-13	58583R	Post-Rear
20 455 0513	Vespa Gts, Gts Abs	250	05-13	58503R	Post-Rear	20 455 0633	Beverly 4t 4v ie Touring	350	11-13	58583R	Post-Rear
20 458 4383	Vespa Gts, Gts Abs	250	05-13	56286R	Ant-Front	20 455 0653	Beverly Eu3	400	06-07	56210R	Post-Rear
20 458 4383	Vespa Gtv	250	06-09	56286R	Ant-Front	20 455 0653	Beverly Tourer Eu3	400	08-10	56210R	Post-Rear
20 458 4383	Vespa Gtv 4t Navy Eu3	250	08	56286R	Ant-Front	20 455 0653	Beverly Cruiser	500	07-12	56210R	Post-Rear
20 455 0683	Beverly 300 ie Tourer	300	-	601014	Post-Rear	20 455 0653	Beverly Eu3	500	06-08	56210R	Post-Rear
20 455 0663	Beverly Rst 4t 4v ie Eu3	300	10-13	58518R	Post-Rear	20 455 0653	Beverly Eu3	500	02-06	56210R	Post-Rear
20 455 0683	Beverly Rst 4t 4v ie Eu3	300	10-12	601014	Post-Rear	20 458 5043	Vespa Px			2329284	Ant-Front
20 455 0683	Beverly Tourer Eu3	300	09-10	601014	Post-Rear	YAMAHA					
20 455 0513	Vespa Gts ie	300	10-12	58503R	Post-Rear	20 455 0163	Bw's Original	50	97-02	4VVF22100000	Post-Rear
20 458 4383	Vespa Gts ie	300	10-12	56286R	Ant-Front	20 455 0163	Bw's Original Eu2	50	03	4VVF22100000	Post-Rear
20 455 0513	Vespa Gts ie Touring	300	11-12	58503R	Post-Rear	20 455 0163	Cw Bw's Original Eu2	50	02	4VVF22100000	Post-Rear
20 458 4383	Vespa Gts ie Touring	300	11-12	56286R	Ant-Front	20 455 0183	Neo's	50	97-06	5KKF22100033	Post-Rear
20 455 0513	Vespa Gts Super	300	08-13	58503R	Post-Rear	20 455 0183	Neo's	100	99-02	5KKF22100033	Post-Rear
20 455 0513	Vespa Gts Super Sport	300	10-13	58503R	Post-Rear	20 455 0503	R X-Max	125	10-12	37PF22100000	Post-Rear
20 455 0513	Vespa Gtv 4t 4v ie	300	10-13	58503R	Post-Rear	20 455 0503	Yp R X-Max Abs	125	11	37PF22100000	Post-Rear
20 458 4383	Vespa Gtv 4t 4v ie	300	10-13	56286R	Ant-Front	20 455 0503	R X-Max	250	10-13	37PF22100000	Post-Rear
20 455 0513	Vespa Gtv Montenapoleone	300	10	58503R	Post-Rear	20 455 0493	Vp X-City	250	09-12	5B2F221020	Post-Rear
20 458 4383	Vespa Gtv Montenapoleone	300	10	56286R	Ant-Front	20 455 0343	Majesty	400	04-11	5RU222103000	Post-Rear
						20 455 0343	Majesty Abs	400	07-11	5RU222103000	Post-Rear

AMMORTIZZATORI PIAGGIO APE

SHOCK ABSORBERS PIAGGIO APE



Marca modello - Trademark model	Codice - Code	Marca modello - Trademark model	Codice - Code
PIAGGIO 50 (Posteriore - Rear): Ape FL-FL2 89-95 • Ape FL3 Europa 96-99 • Ape Mix 2T 98-08 • Ape P 80-85 • Ape Rst Mix 99-03 • Ape Tm P 85-89 • Ape 09-16 (R.O. 2682514 • 56597R • 646464)	20 456 5002 	PIAGGIO 50 (Anteriore - Front): Ape FL-FL2 89-95 • Ape FL3 Europa 96-99 • Ape Mix 2T 98-08 • Ape P 80-85 • Ape Rst Mix 99-03 • Ape Tm P 85-89 • Ape 09-16 (R.O. 1366414 • 646463 • 566502)	20 458 5002
PIAGGIO 220 (Anteriore - Front): Ape Car P2-P3 78-85 420 (Anteriore - Front): Ape Calessino-Vme 07-12 (R.O. 1364514)	20 458 5012 	PIAGGIO 220 (Anteriore - Front): Ape Mp P501-P601 78-96 (R.O. 566503 • 244949)	20 458 5022
PIAGGIO 220 (Anteriore - Front): Ape Tm P602 82-83 (R.O. 225533)	20 458 5032 	PIAGGIO 220 (Anteriore - Front): Ape Tm P703 FL2 99-07 • Ape Tm P703-P703V-FL2 84-05 • Ape Tm 09-16 420 (Anteriore - Front): Ape Car - Max Diesel 86-96 • Ape Tm Diesel Lcs 05-12 • Ape Tm P703-P703V Diesel 87-04 (R.O. 2449504 • 646465 • 56602R • 566506 • 566507)	20 458 5042
PIAGGIO 220 (Posteriore - Rear): Ape Car P2-P3 78-85 (R.O. 2449454 • 566504)	20 456 5012 		



ACCESSORI PER AMMORTIZZATORI

SHOCK ABSORBER ACCESSORIES

12 187 0120 

PROLUNGA AMMORTIZZATORE POSTERIORE
REAR SHOCK ABSORBERS EXTENSION mm 42
PIAGGIO 125-150: Vespa Super



12 187 0130 

PROLUNGA AMMORTIZZATORE POSTERIORE
REAR SHOCK ABSORBERS EXTENSION mm 26
PIAGGIO 150: Vespa Sprint • GL • Sprint Veloce
• Super
180-200: Vespa Rally
(R.O. 070642)



12 187 0140 

PROLUNGA AMMORTIZZATORE POSTERIORE
REAR SHOCK ABSORBERS EXTENSION mm 52
PIAGGIO 125-150-200: Vespa Px
(R.O. 149871)



12 187 0150 

PROLUNGA AMMORTIZZATORE POSTERIORE
REAR SHOCK ABSORBERS EXTENSION mm 48
PIAGGIO 125-150-200: Vespa Px
Arcobeleno T5
(R.O. 199344)



12 187 0090 

GILERA: Typhoon
PIAGGIO: Nrg
Colore alluminio naturale
Alloy Colour



12 187 0101 

MBK: Nitro - **YAMAHA:** Aerox
Nero - *Black*

12 187 0100 

MBK: Nitro - **YAMAHA:** Aerox
Cromato - *Chromed*

12 187 0102 

MBK: Nitro - **YAMAHA:** Aerox
Bianco - *White*



12 187 0108 

MBK: Nitro - **YAMAHA:** Aerox
Colore carbon - *Carbon colour*



12 187 0110 

PEUGEOT: Speedfight
Colore cromato - *Chromed colour*

12 187 0111 

Nero - *Black*

12 187 0118 

Carbon - *Carbon colour*



12 187 0070 

YAMAHA MINARELLI 50
Colore alluminio naturale - *Alloy Colour*



12 187 0071 

YAMAHA MINARELLI 50
Colore nero - *Colour black*



▶ PASTIGLIE FRENO

BRAKE PADS

▶ **RMS**
YOUR BEST PARTNER

▶ **SINTER**
HIGH PERFORMANCE *BRACKS*

Scopri la vasta gamma di pastiglie organiche
RMS Made in Italy e Testate TUV.
 Garantiscono performance durature e bassa usura del disco.

Coprono completamente il mercato degli scooter e rappresentano la soluzione ideale sia per applicazioni off-road che stradali.

Here it is the wide range of **RMS** organic brake pads Made in Italy and TUV Tested.
 RMS brake pads ensure lasting performances and low consumption of the disc.
 Scooter market is completely covered and they are the ideal solution also for off-road driving.



RMS presenta nel suo catalogo la linea di pastiglie freno **SINTER**
 La gamma **SINTER** include pastiglie freno sintetizzate a base metallo con elevato coefficiente d'attrito. Le pastiglie **SINTER** garantiscono inoltre una lunga durata.
 Con un ottimo rapporto qualità prezzo sono l'ideale per una guida sicura.

RMS is proud to show in the new catalogue the new line of **SINTER** brake pads
 Sintered brake pads with a metal-based compound with a high friction coefficient, high performance, durability and resistance on heavy and city use, combined with a high pad life.
 With an excellent value for money they are the best choice for a safe driving.



COME INTERPRETARE CODICI PASTIGLIE FRENO



Codice finale
Final number 0 =



HOW TO READ BRAKE PADS RMS CODES



Codice finale
Final number 3 =



I codici con il numero 0 finale: **MESCOLA ORGANICA**
I codici con il numero 3 finale: **MESCOLA SINTERIZZATA**
Non omologata

PASTIGLIE FRENO IN ORDINE DI CODICE

BRAKE PADS SEARCH BY CODE NUMBER



22 510 0010

22 510 0013



22 510 0020



22 510 0030

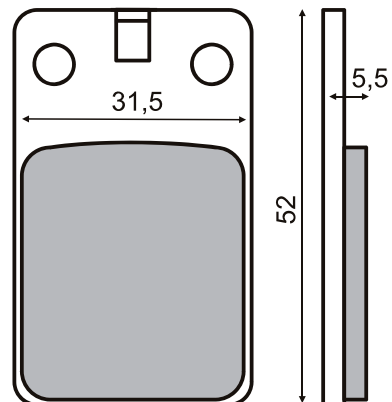
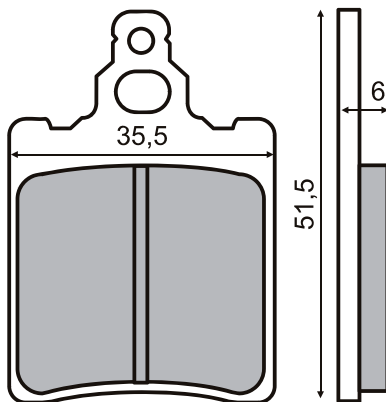
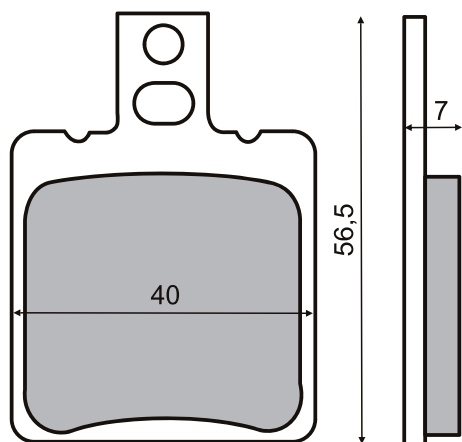

22 510 0040

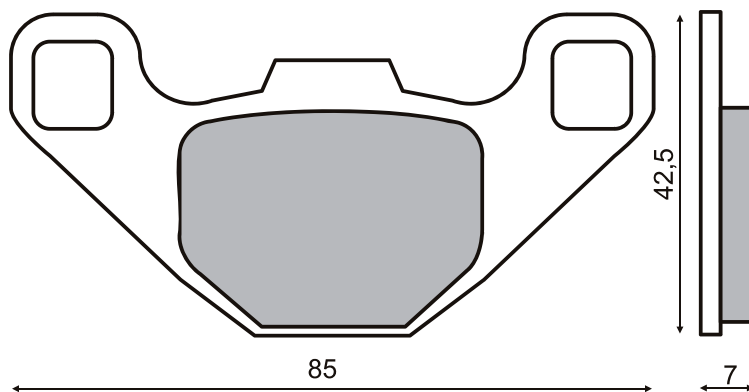
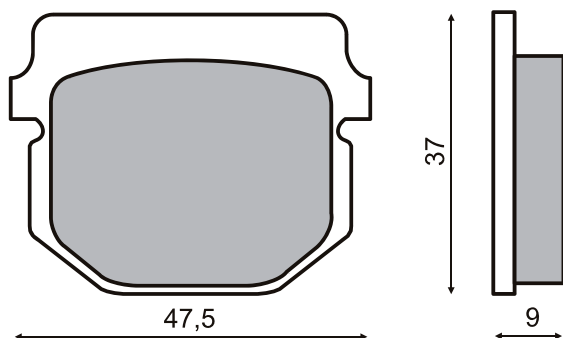

22 510 0060

22 510 0063

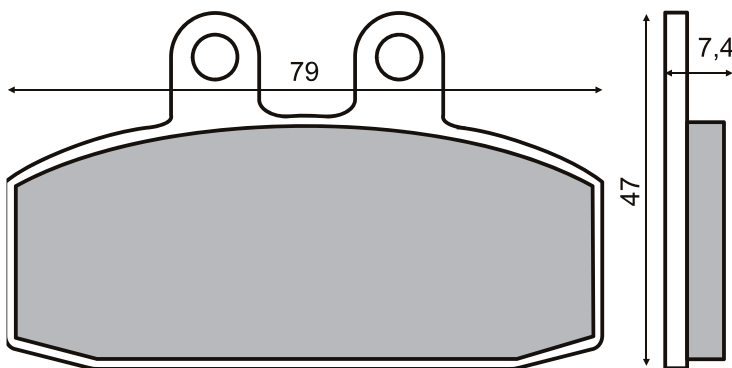

22 510 0070

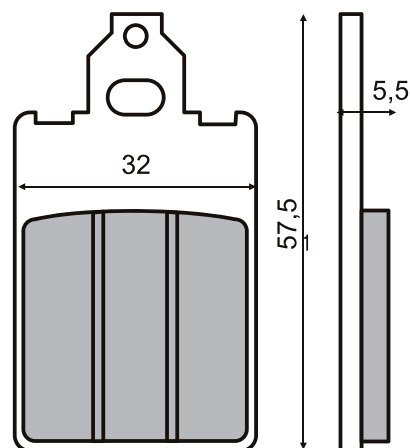



PASTIGLIE FRENO IN ORDINE DI CODICE
BRAKE PADS SEARCH BY CODE NUMBER

22 510 0080



22 510 0083

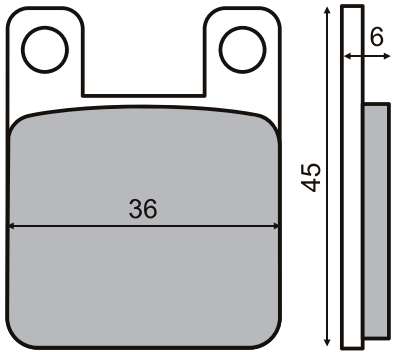

22 510 0120

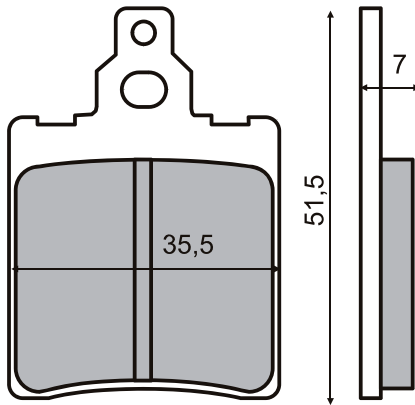

22 510 0140

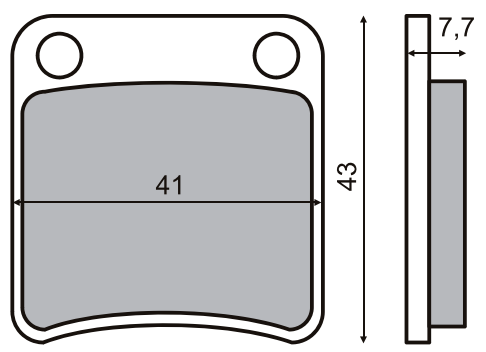

22 510 0130

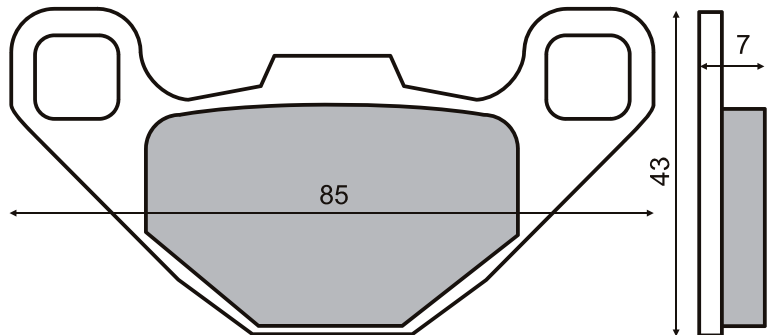
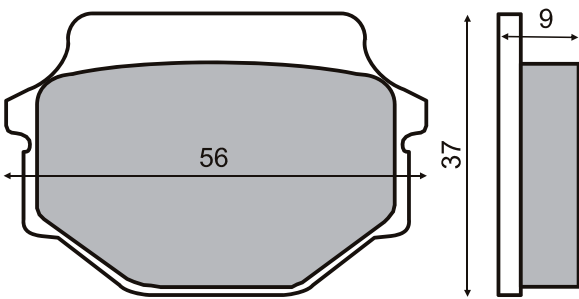

22 510 0160

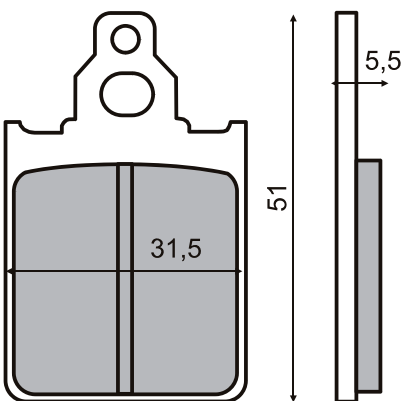

22 510 0170

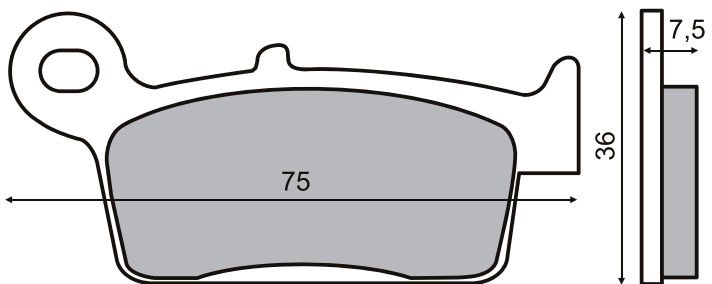

22 510 0180

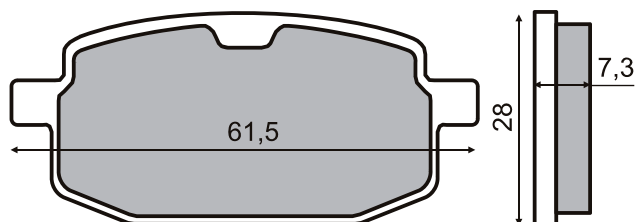



22 510 0190



22 510 0193

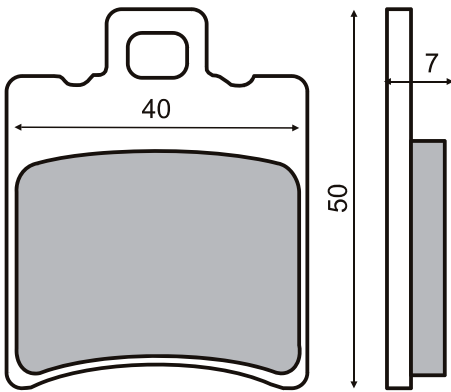

22 510 0210

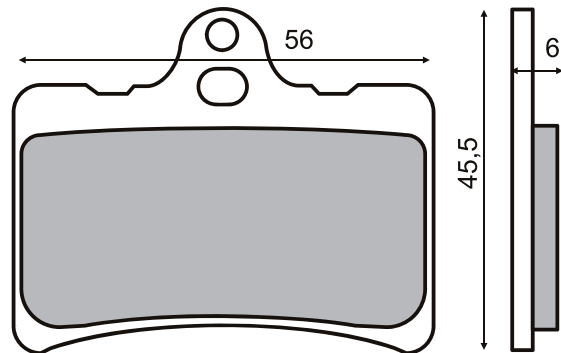

22 510 0230

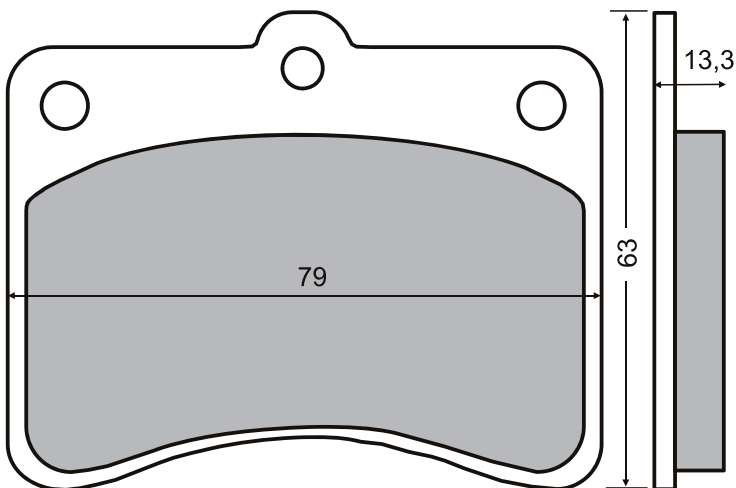

22 510 0240

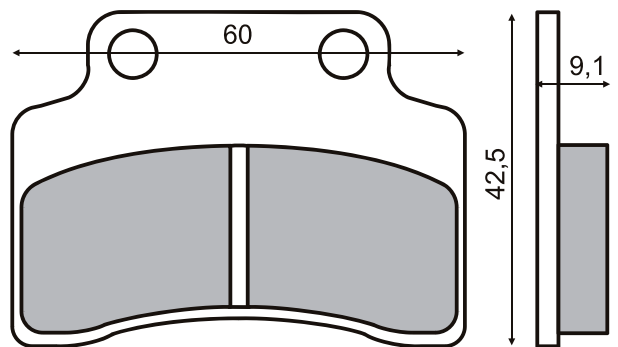

22 510 0250

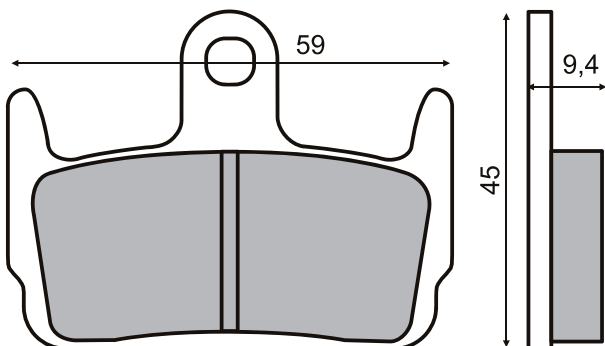

22 510 0260

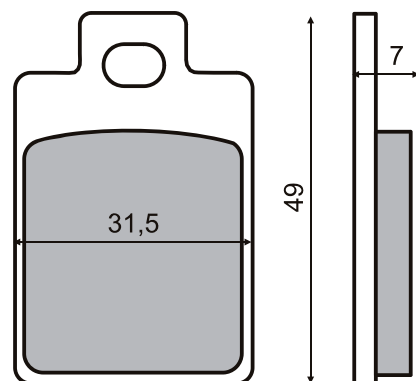



PASTIGLIE FRENO IN ORDINE DI CODICE

BRAKE PADS SEARCH BY CODE NUMBER

22 510 0270



22 510 0273

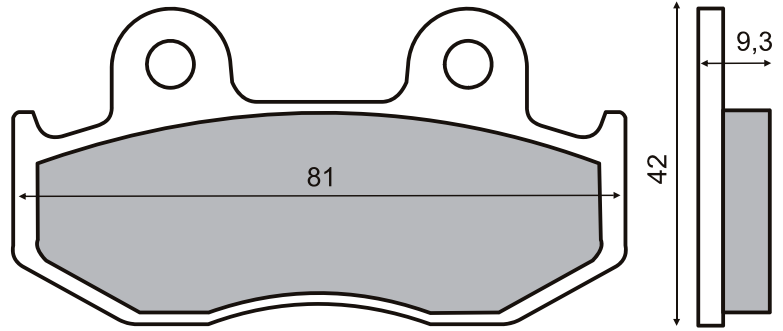

22 510 0280

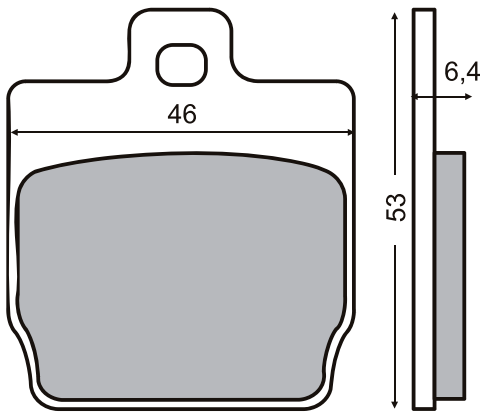

22 510 0300



22 510 0303

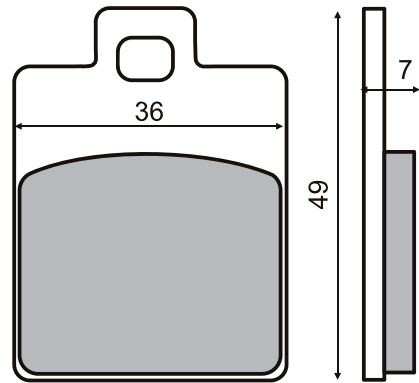

22 510 0310



22 510 0313



22 510 0330

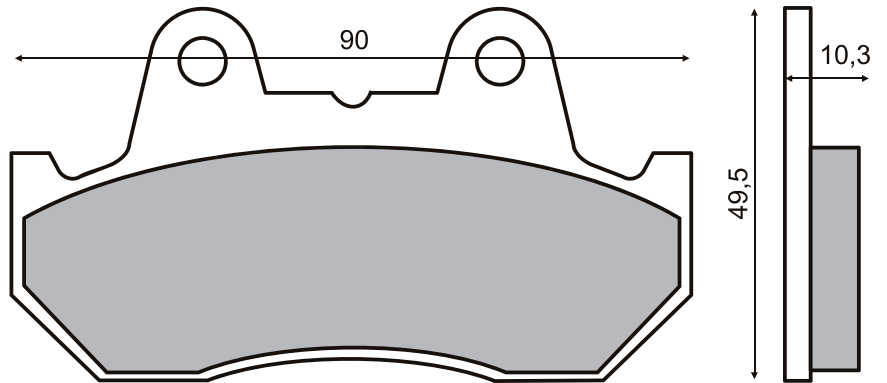
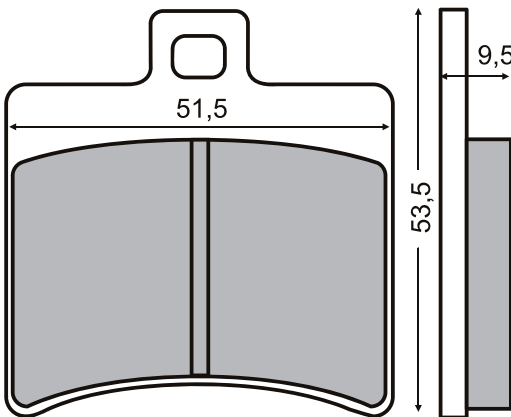

22 510 0340



22 510 0343

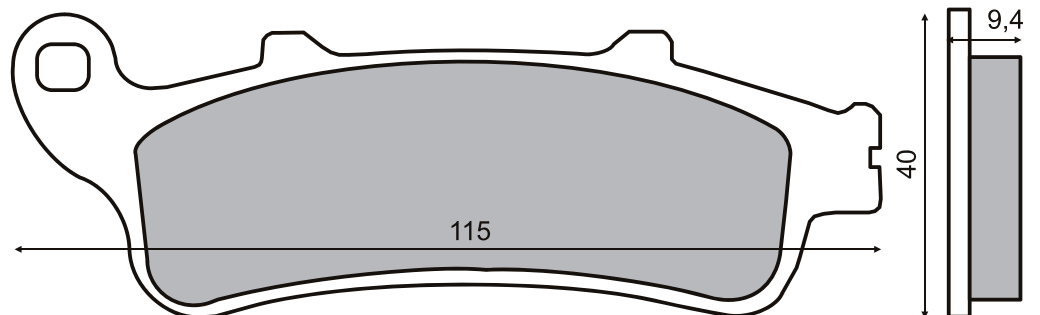

I codici con il numero 0 finale: **MESCOLA ORGANICA**
I codici con il numero 3 finale: **MESCOLA SINTERIZZATA**
Non omologata

PASTIGLIE FRENO IN ORDINE DI CODICE

BRAKE PADS SEARCH BY CODE NUMBER



22 510 0350 

22 510 0353 

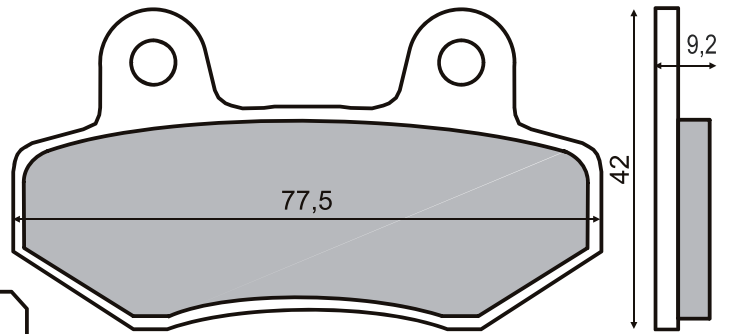
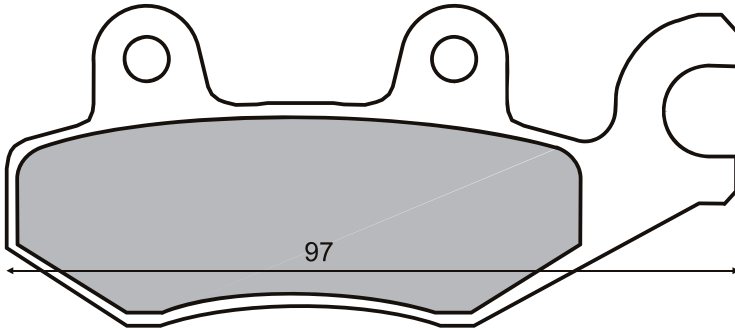

22 510 0360 

22 510 0363 

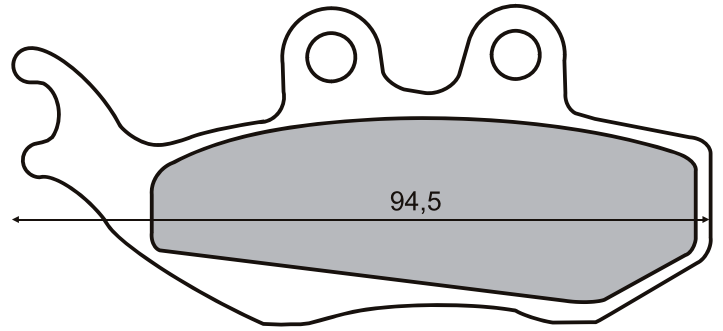
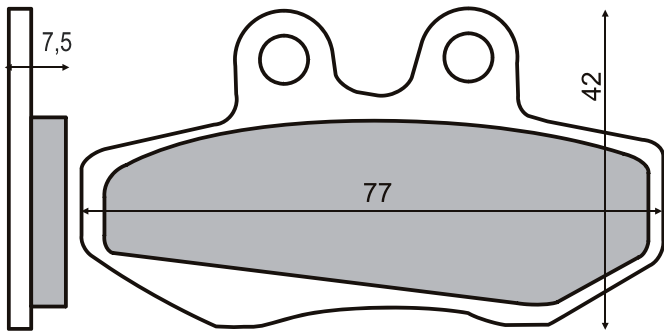

22 510 0380 

22 510 0383 

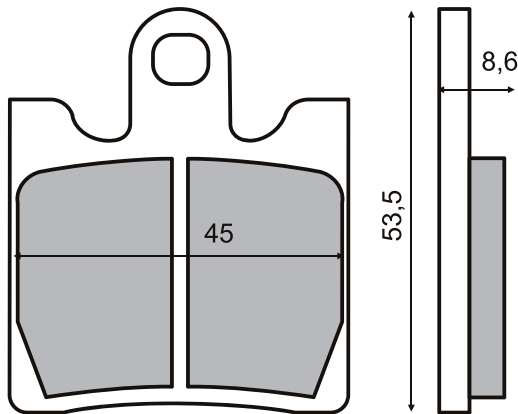

22 510 0400 

22 510 0403 

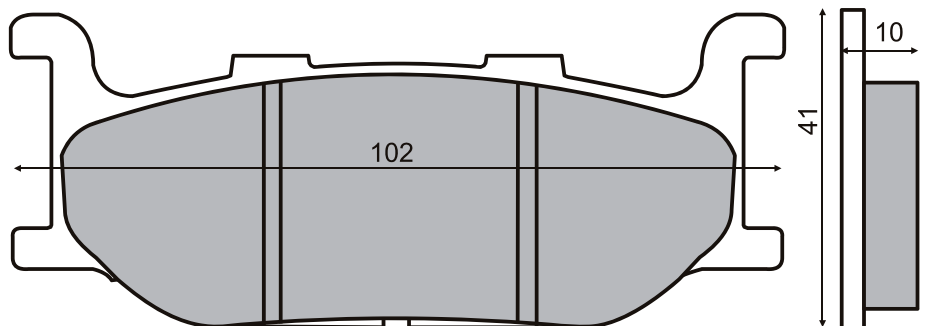



PASTIGLIE FRENO IN ORDINE DI CODICE

BRAKE PADS SEARCH BY CODE NUMBER

22 510 0410



22 510 0413

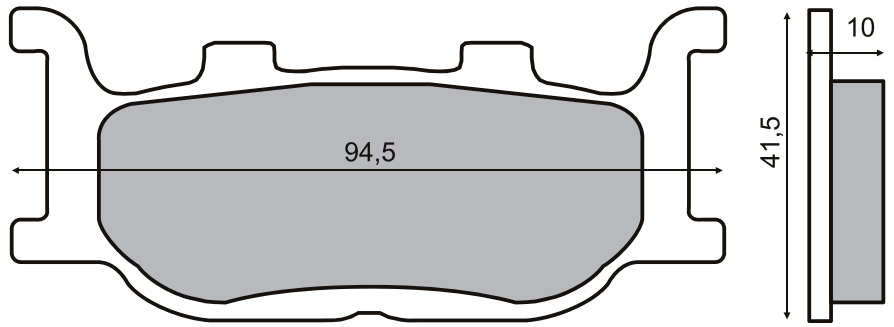

22 510 0430

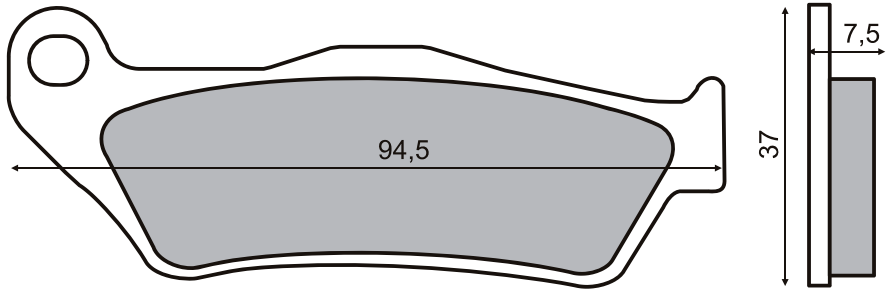

22 510 0450



22 510 0453

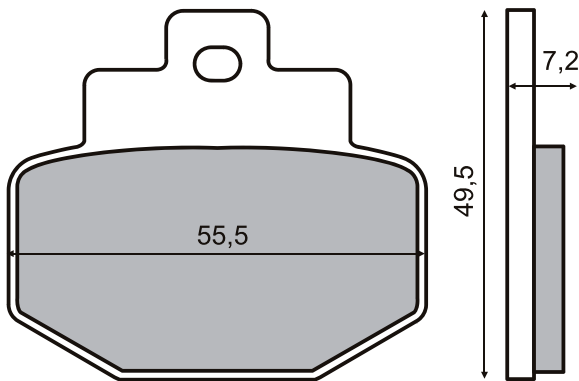

22 510 0460

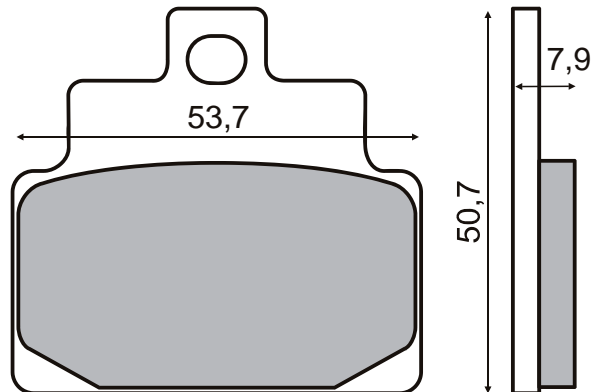

22 510 0470

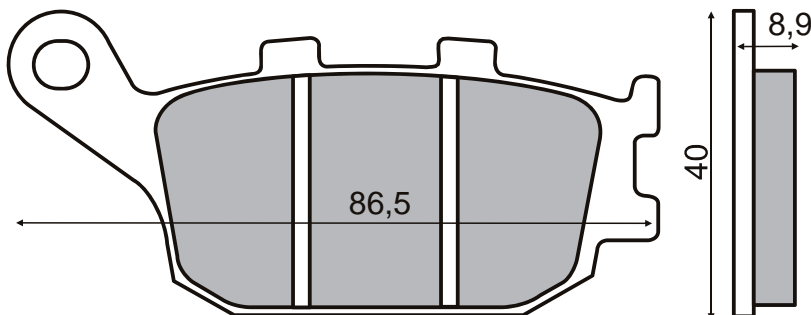

22 510 2810

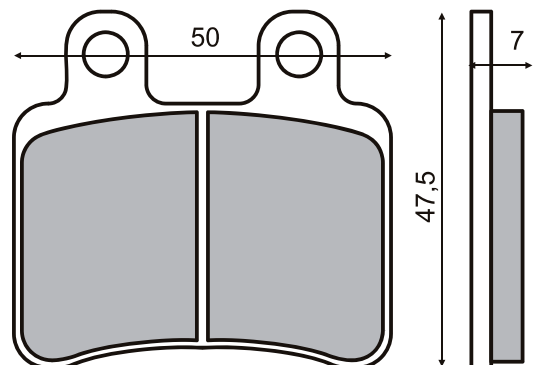

I codici con il numero 0 finale: **MESCOLA ORGANICA**
 I codici con il numero 3 finale: **MESCOLA SINTERIZZATA**
 ■ Non omologata

PASTIGLIE FRENO IN ORDINE DI CODICE
BRAKE PADS SEARCH BY CODE NUMBER



22 510 0490

22 510 0493

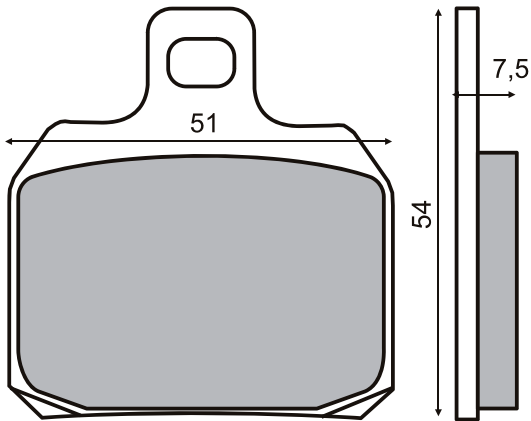

22 510 0500

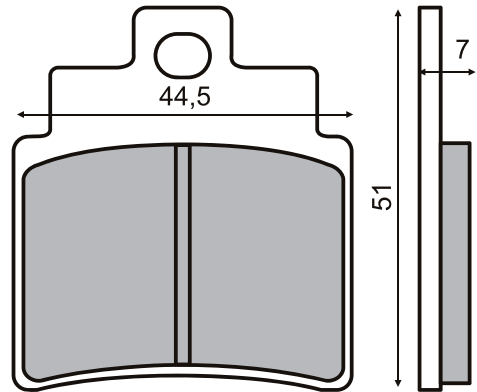

22 510 0510

22 510 0520

22 510 0523

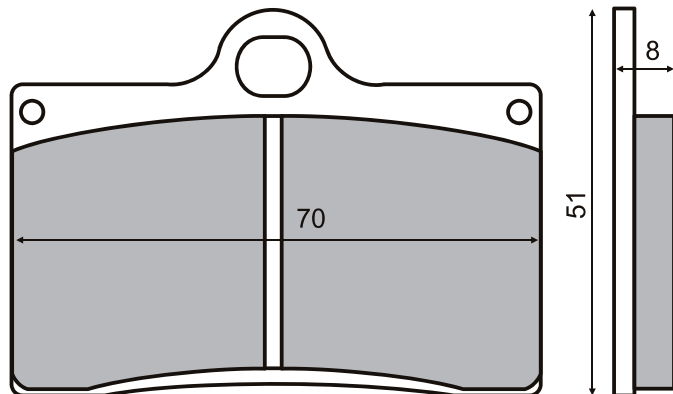
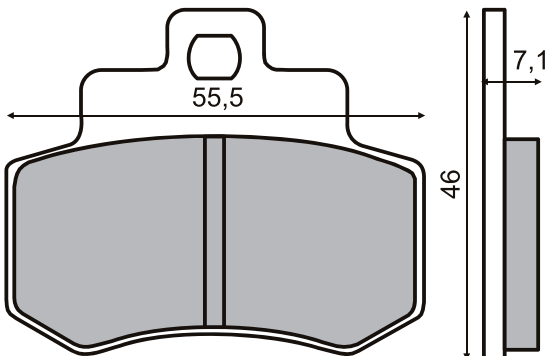

22 510 0530

22 510 0533



22 510 0540

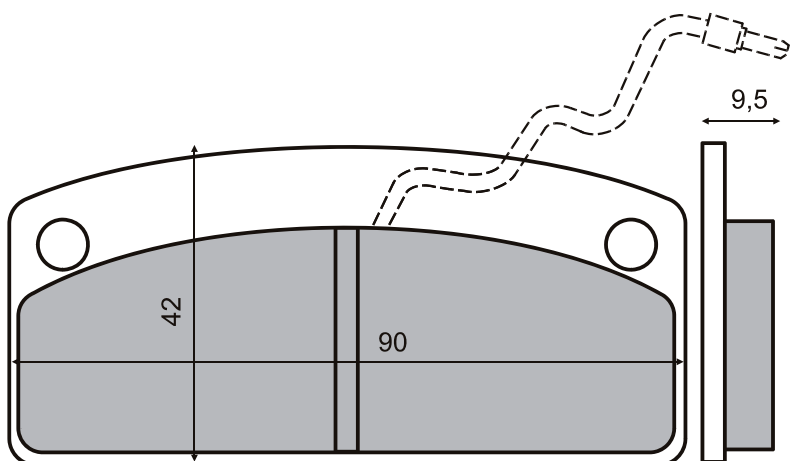
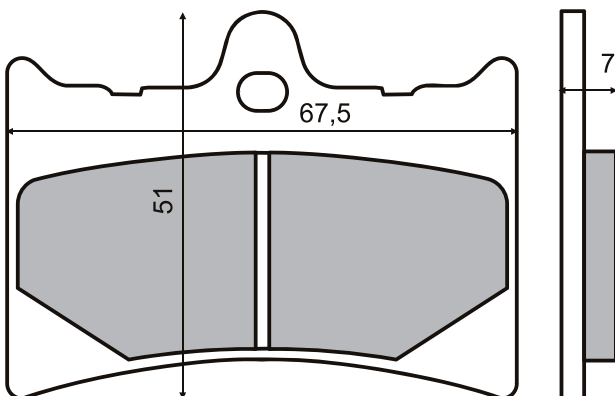



PASTIGLIE FRENO IN ORDINE DI CODICE

BRAKE PADS SEARCH BY CODE NUMBER

22 510 0560

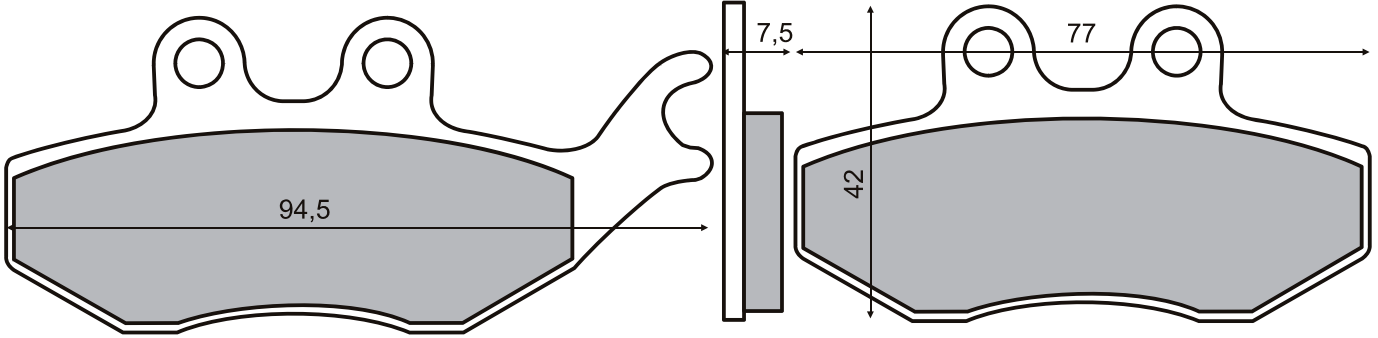

22 510 0570



22 510 0573

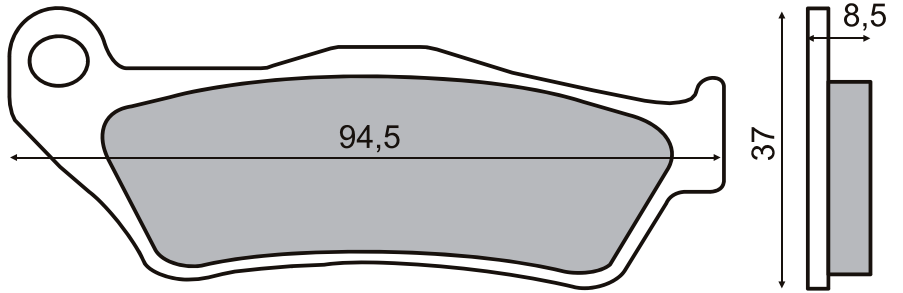

22 510 0580



22 510 0583

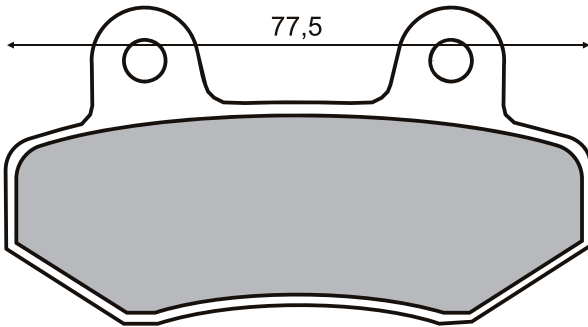

22 510 0630

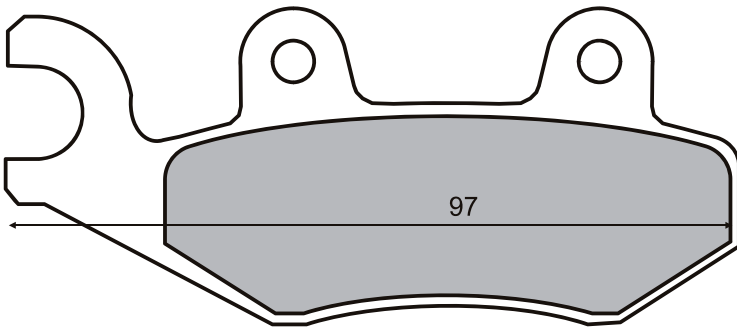
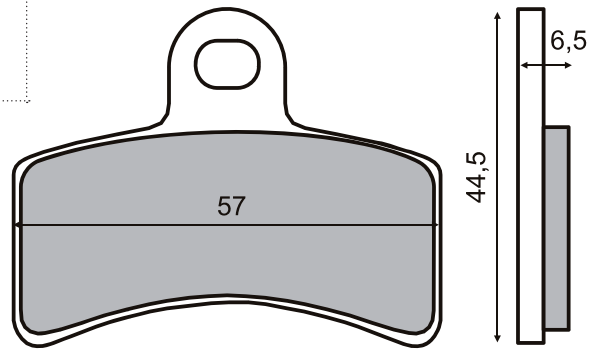

22 510 0640

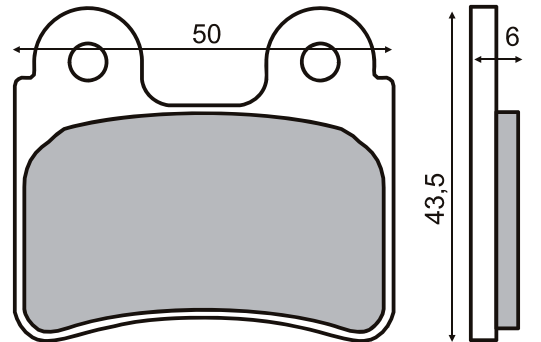

22 510 0650

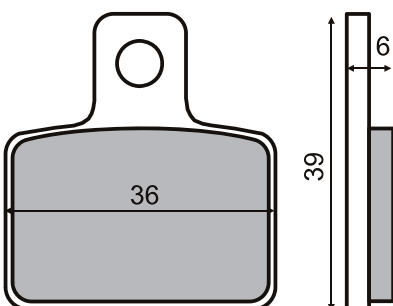

22 510 0670

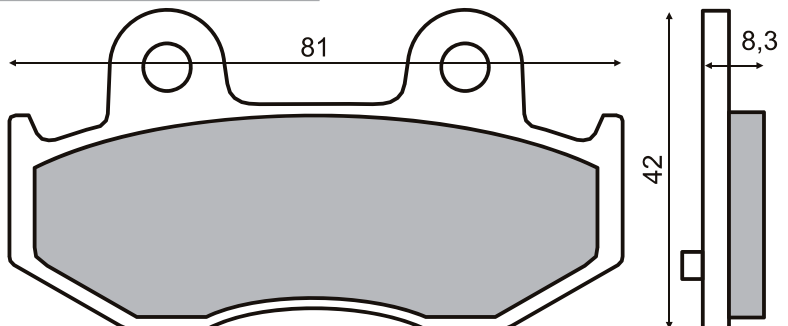



22 510 0660 

22 510 0663 

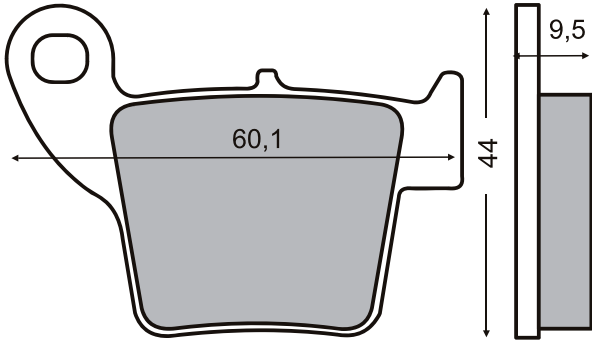

22 510 0680 

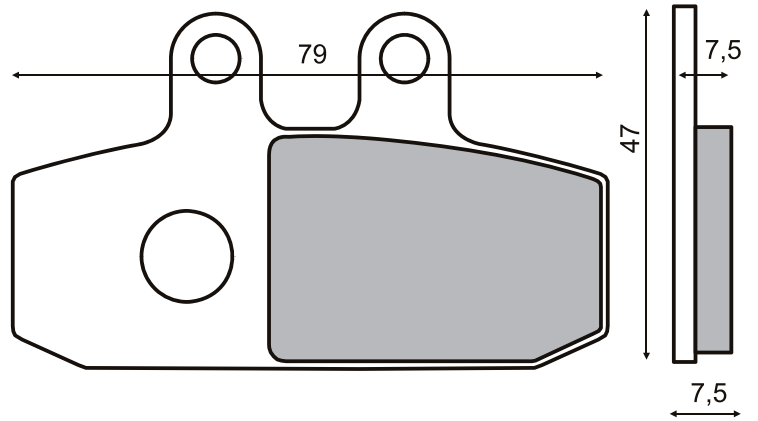

22 510 0690  

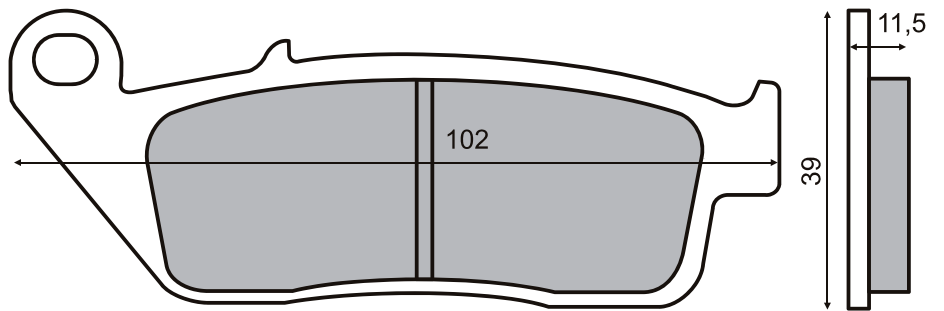

22 510 0720 

22 510 0723  

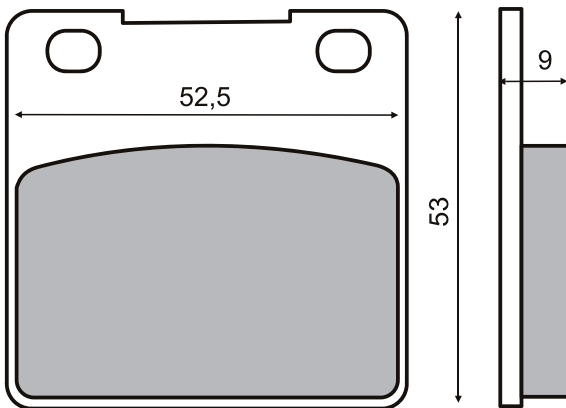

22 510 0730 

22 510 0733  

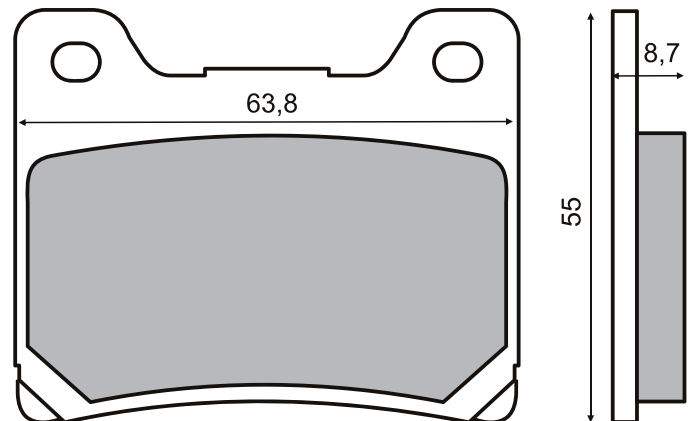

22 510 0740 

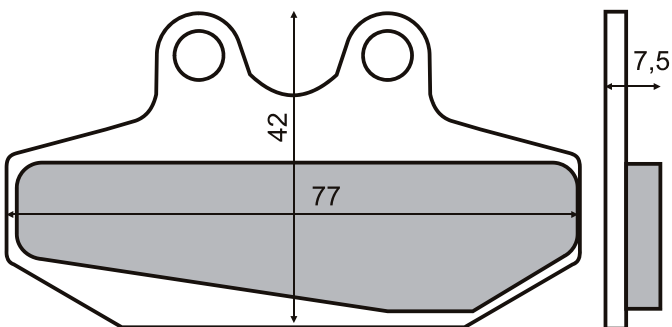

22 510 0750 

22 510 0753 

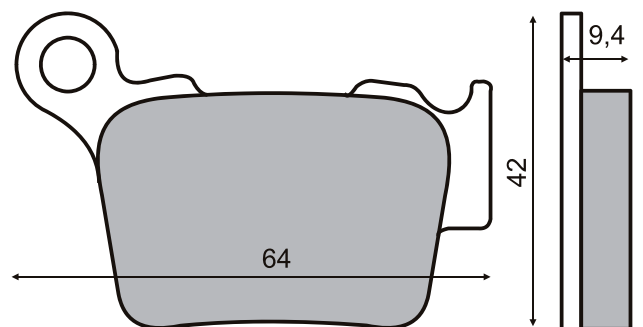



PASTIGLIE FRENO IN ORDINE DI CODICE
BRAKE PADS SEARCH BY CODE NUMBER

22 510 0760

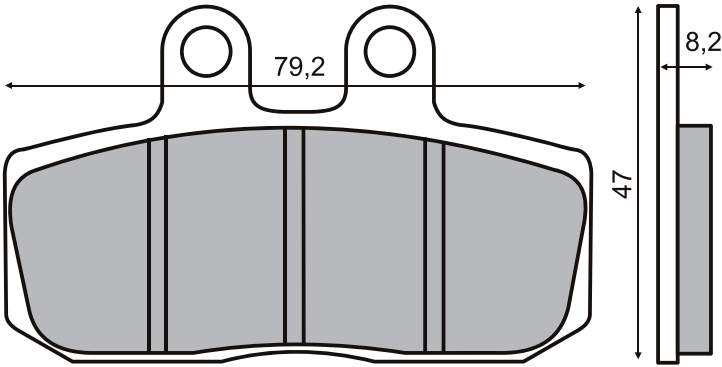

22 510 0780

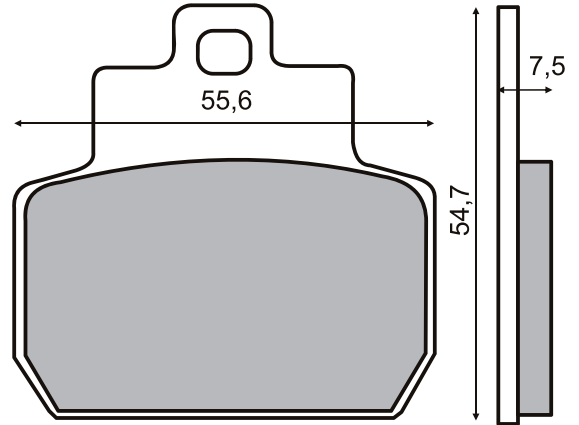

22 510 0770

22 510 0773

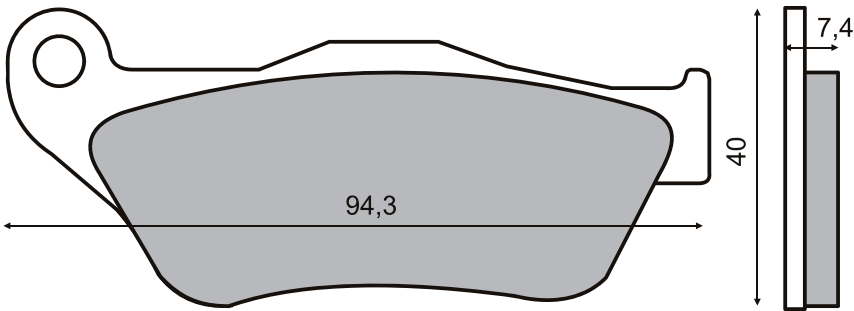

22 510 0800

22 510 0803

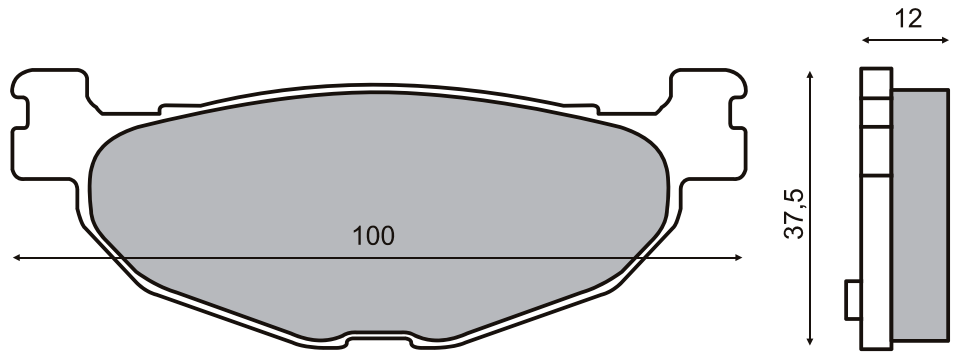

22 510 0870

22 510 0873

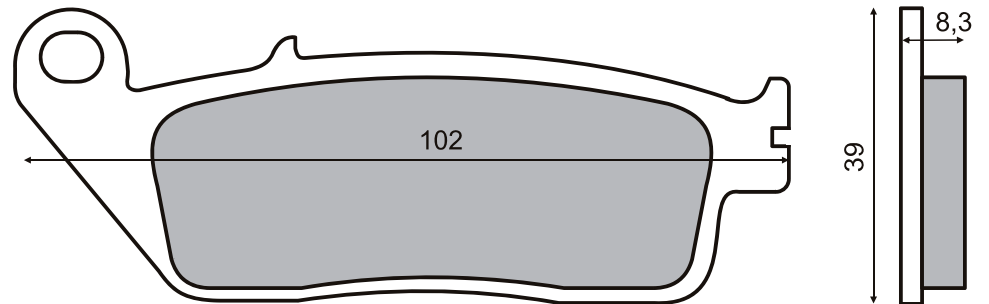

22 510 0890

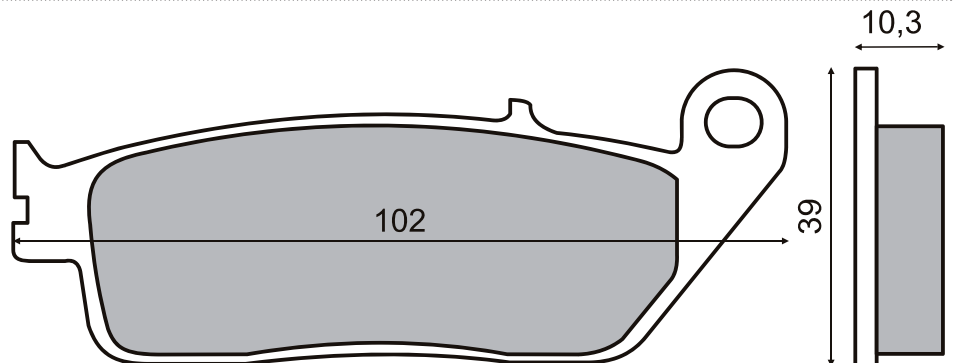

I codici con il numero 0 finale: **MESCOLA ORGANICA**
I codici con il numero 3 finale: **MESCOLA SINTERIZZATA**
+ Non omologata

PASTIGLIE FRENO IN ORDINE DI CODICE

BRAKE PADS SEARCH BY CODE NUMBER



22 510 0920 

22 510 0923 

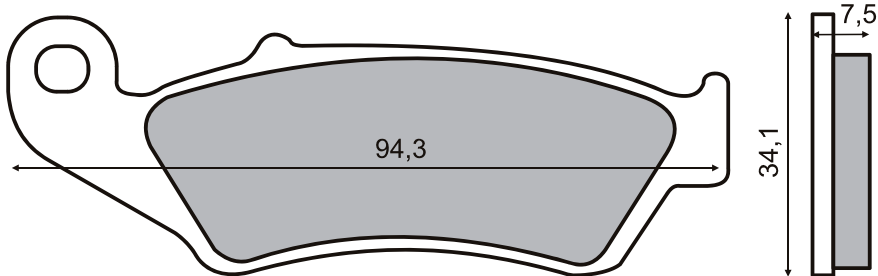

22 510 0930 

22 510 0933 

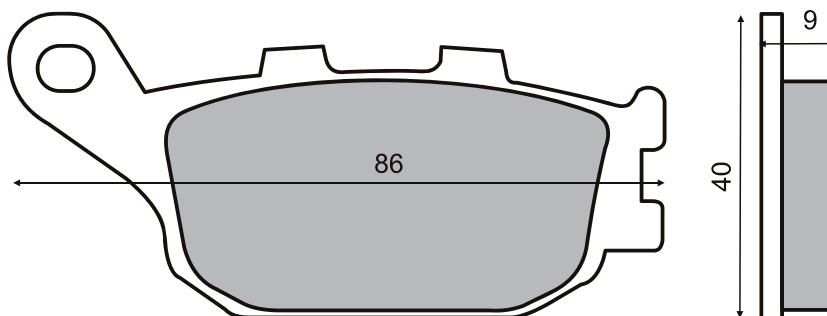

22 510 0970 

22 510 0973 

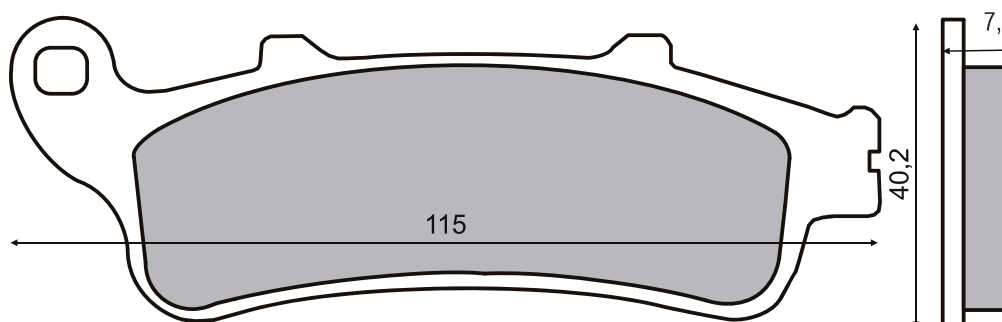

22 510 1010 

22 510 1013 

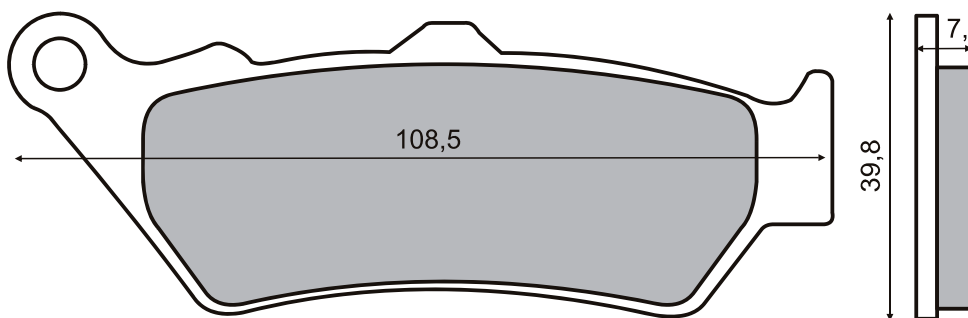

22 510 1060 

22 510 1063 

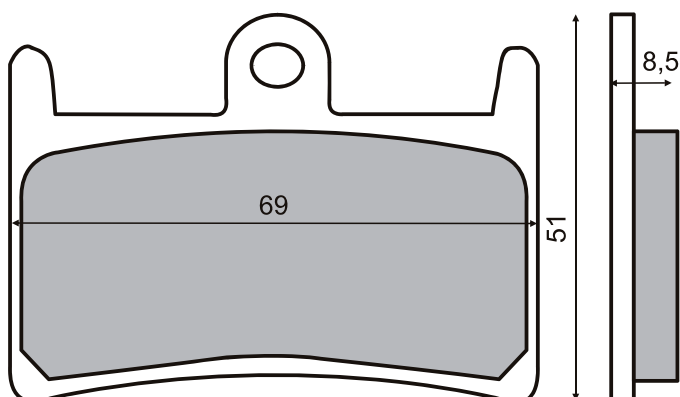



PASTIGLIE FRENO IN ORDINE DI CODICE

BRAKE PADS SEARCH BY CODE NUMBER

22 510 1070 

22 510 1073 

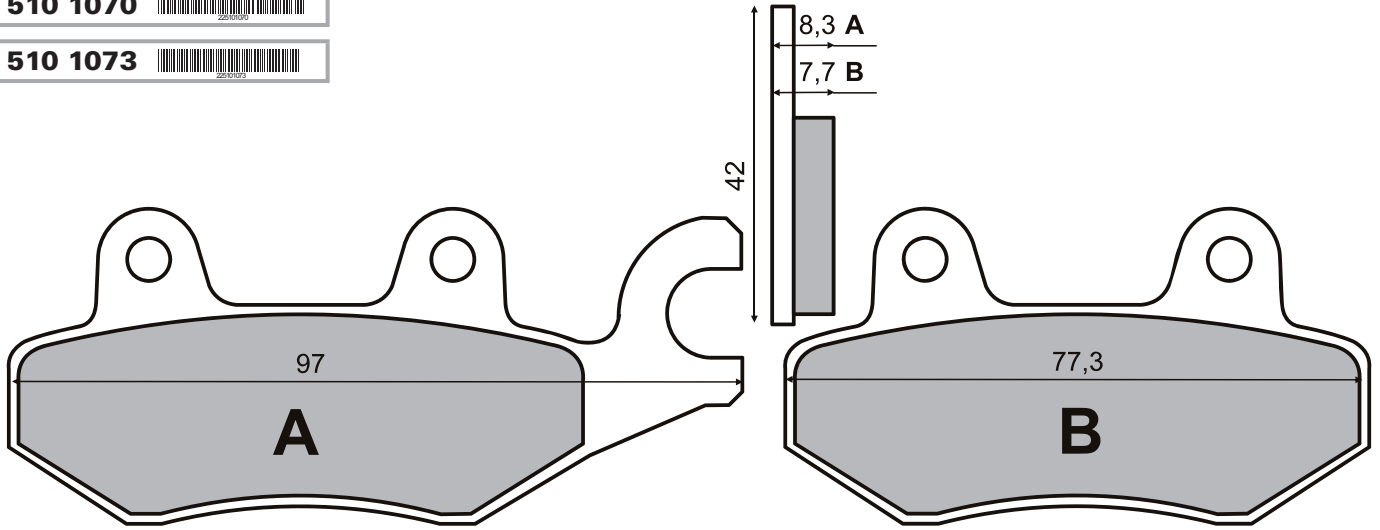

22 510 1100 

22 510 1103 

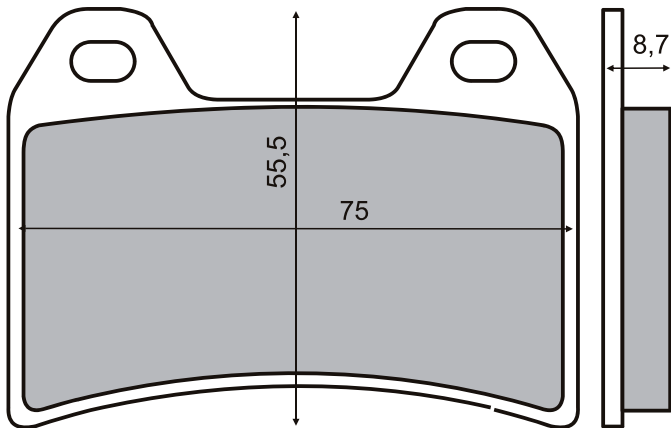

22 510 1150 

22 510 1153 

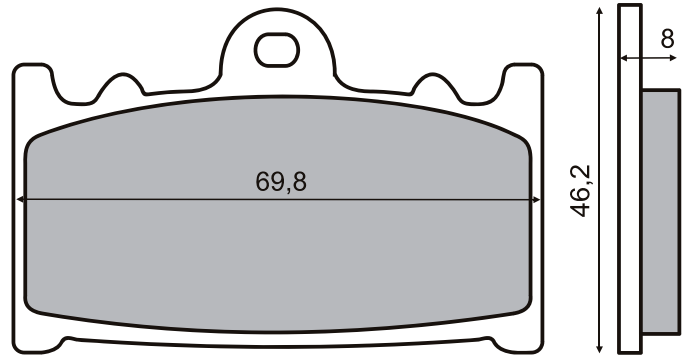

22 510 1170 

22 510 1173 

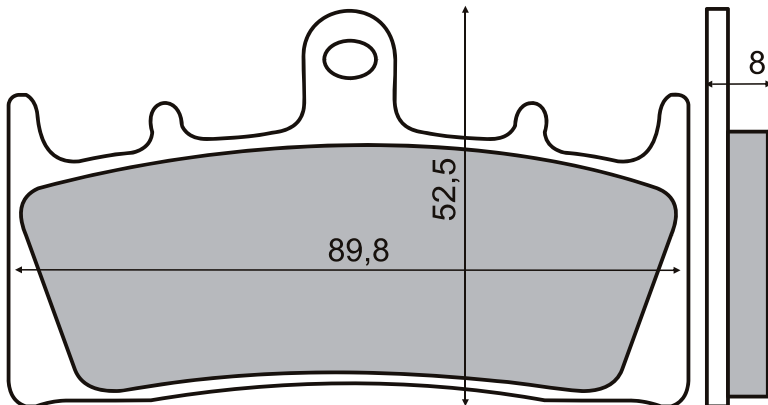

22 510 1190 

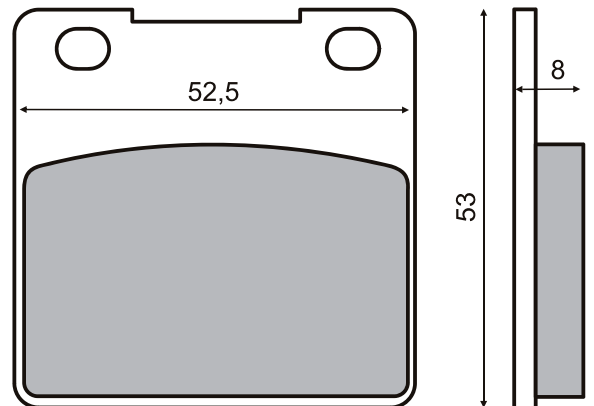

I codici con il numero 0 finale: **MESCOLA ORGANICA**
I codici con il numero 3 finale: **MESCOLA SINTERIZZATA**
Non omologata

PASTIGLIE FRENO IN ORDINE DI CODICE

BRAKE PADS SEARCH BY CODE NUMBER



22 510 1200

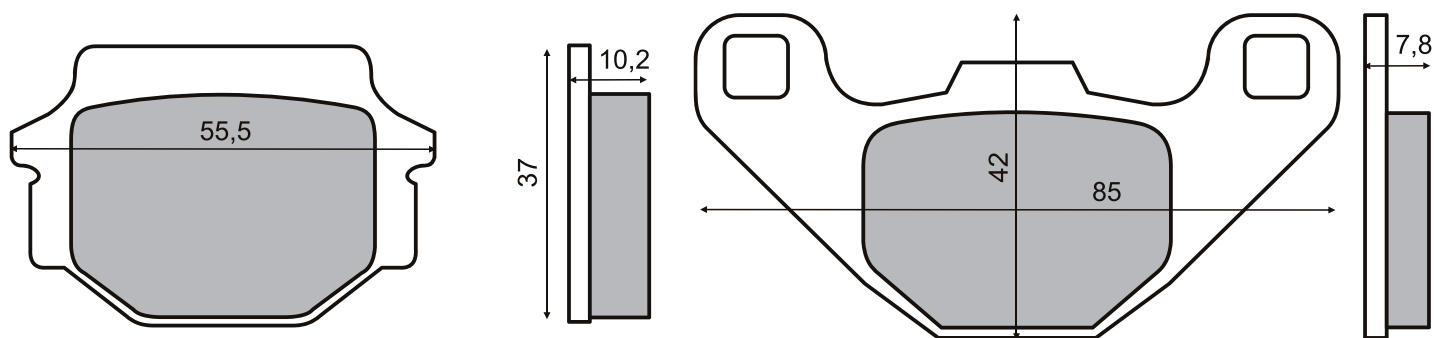

22 510 1220

22 510 1223

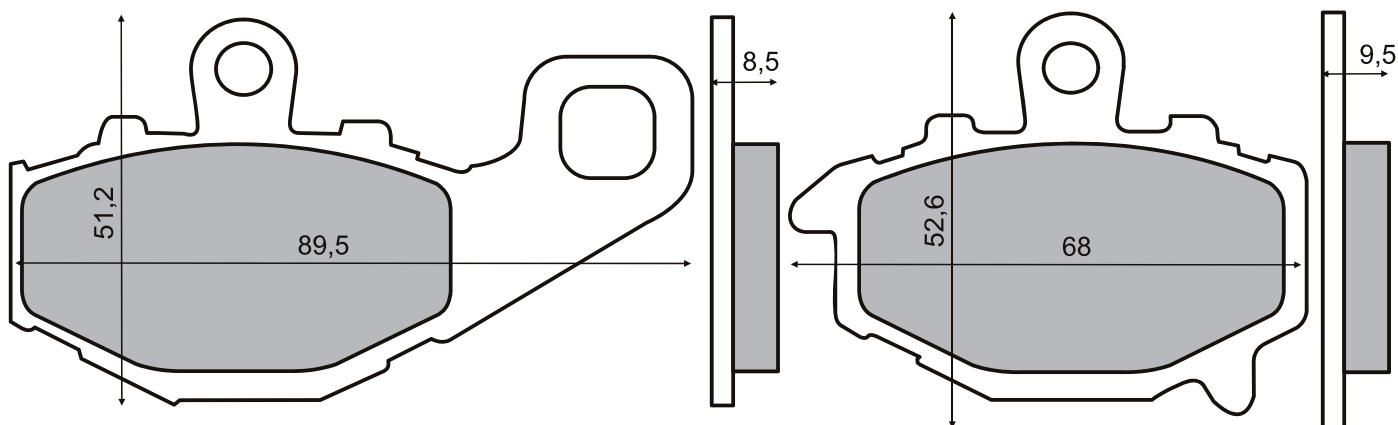

22 510 1240

22 510 1243

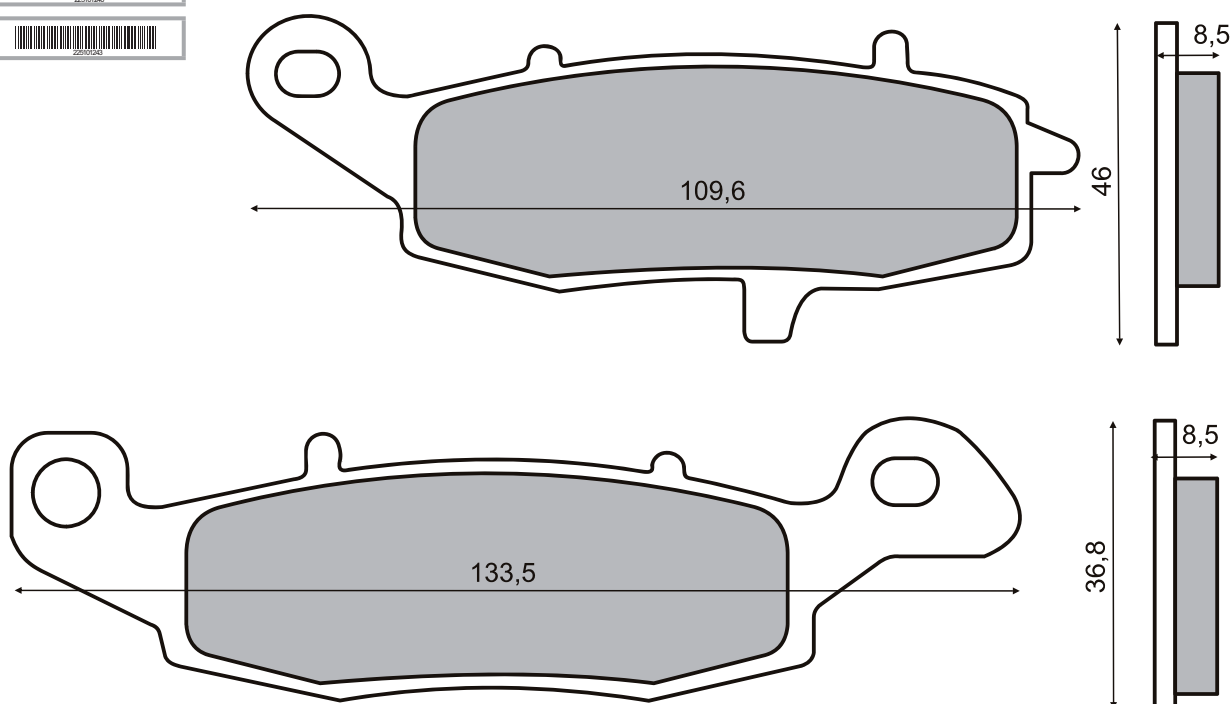



PASTIGLIE FRENO IN ORDINE DI CODICE
BRAKE PADS SEARCH BY CODE NUMBER

22 510 1250



22 510 1253

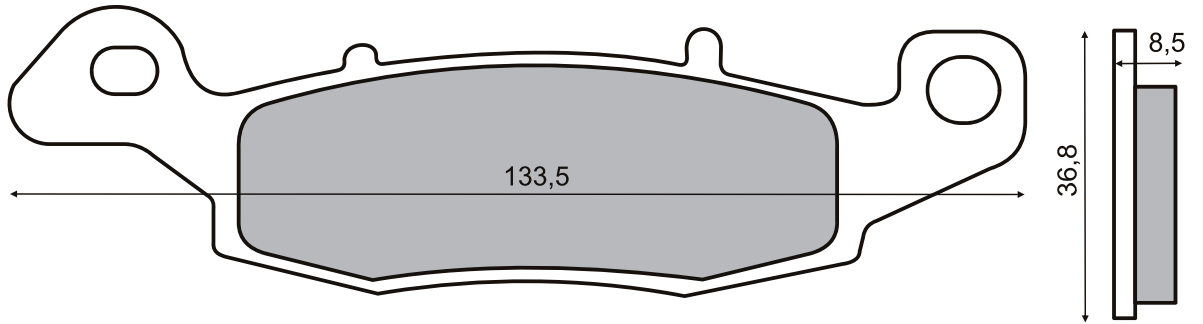
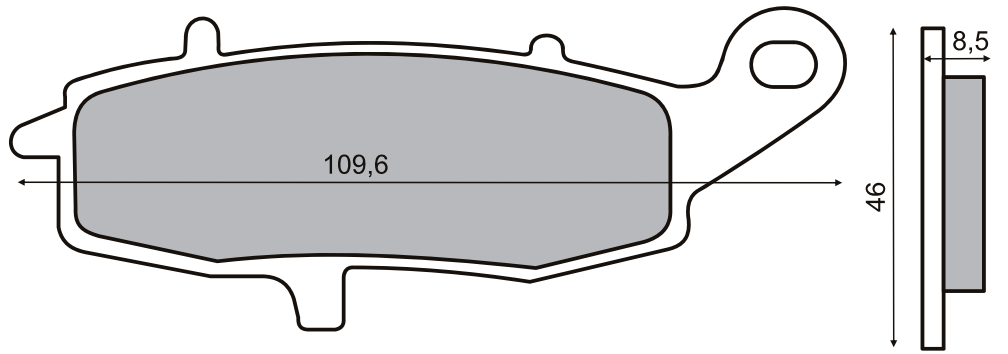

22 510 1330



22 510 1333

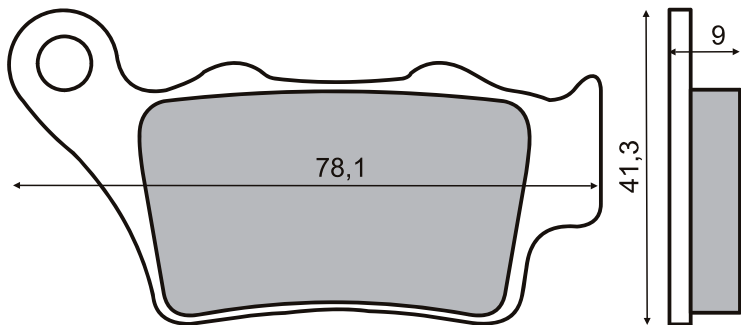

22 510 1380



22 510 1383

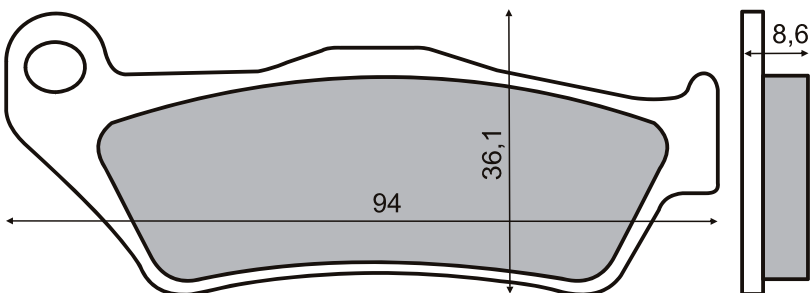
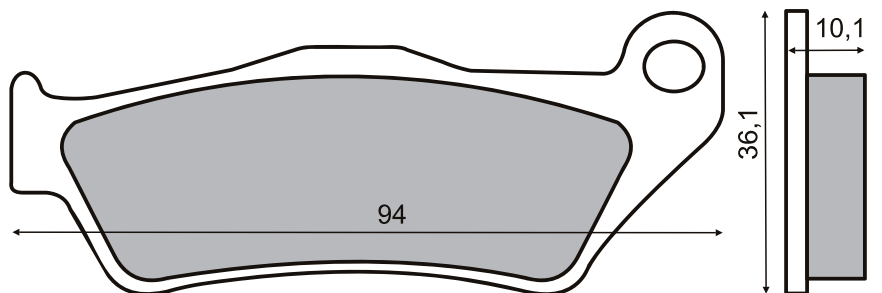

I codici con il numero 0 finale: **MESCOLA ORGANICA**
 I codici con il numero 3 finale: **MESCOLA SINTERIZZATA**
 ■ Non omologata

PASTIGLIE FRENO IN ORDINE DI CODICE
BRAKE PADS SEARCH BY CODE NUMBER



22 510 1400

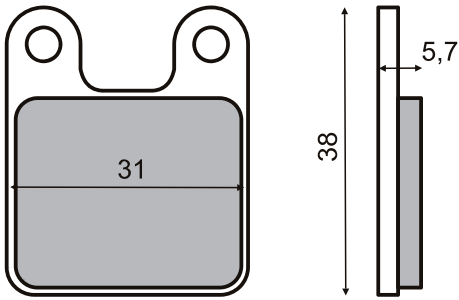

22 510 1410

22 510 1413

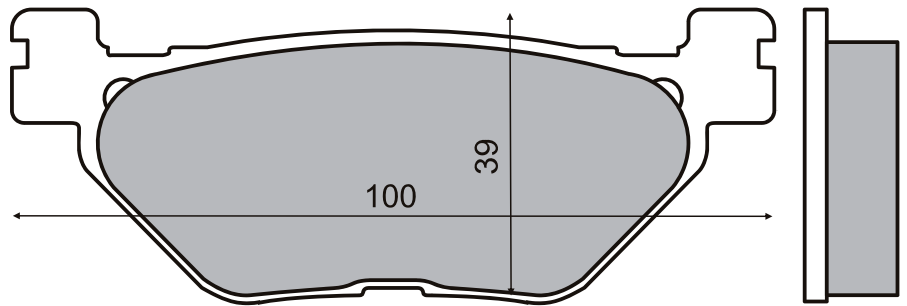

22 510 1430

22 510 2730

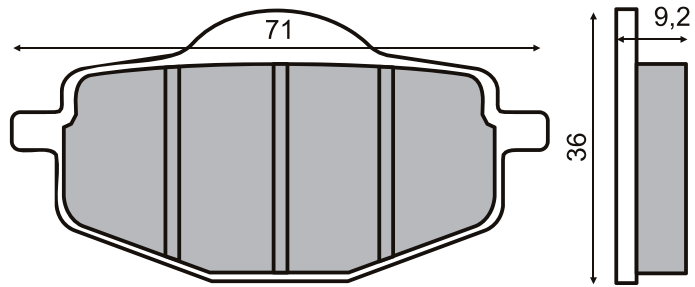

22 510 1420

22 510 1423

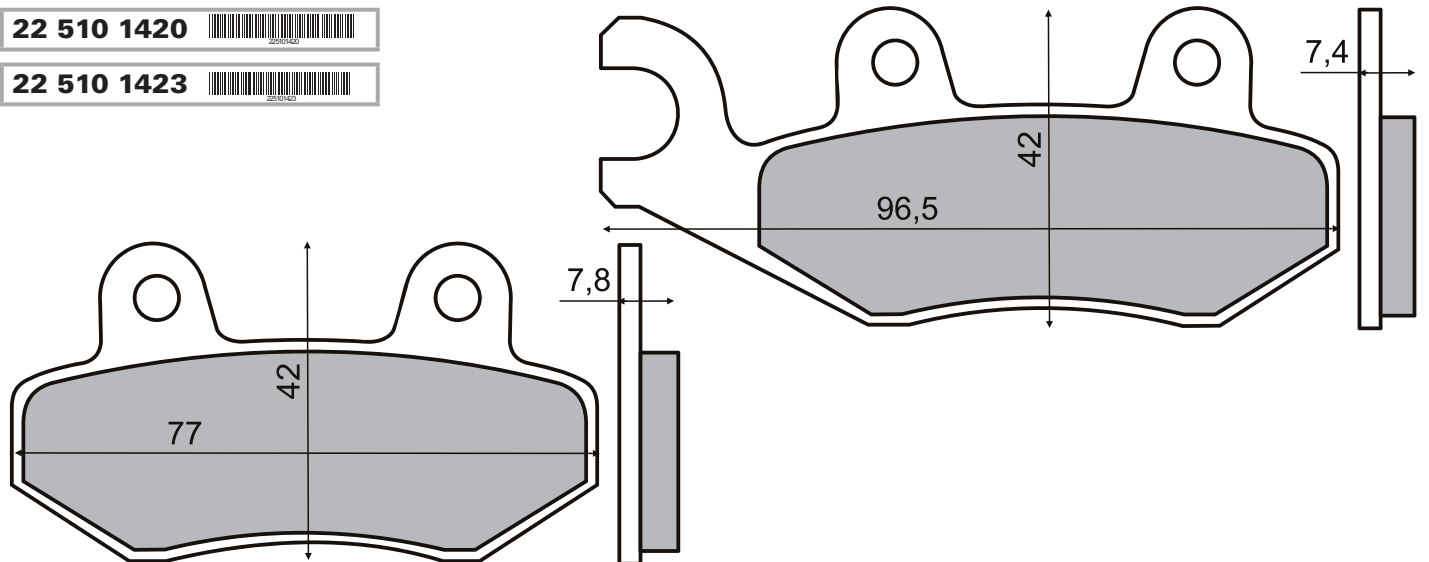

22 510 1450

22 510 1453

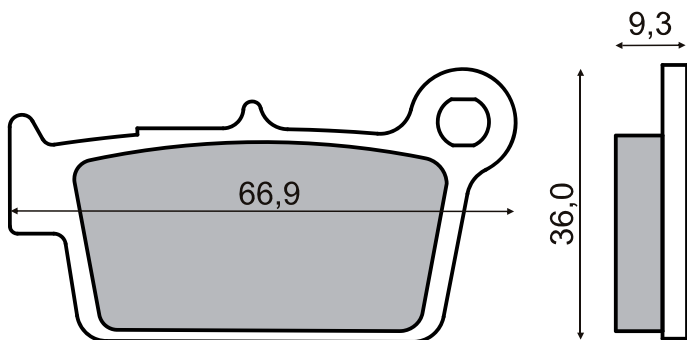

22 510 1440

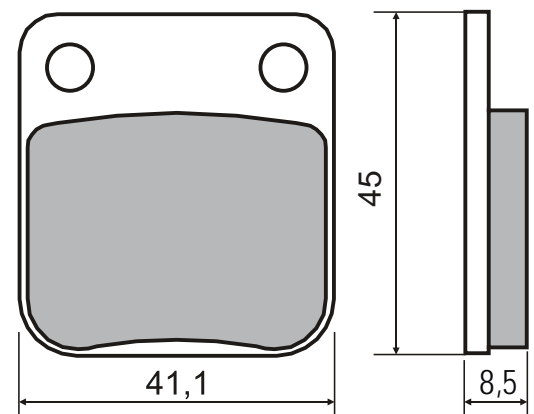



PASTIGLIE FRENO IN ORDINE DI CODICE

BRAKE PADS SEARCH BY CODE NUMBER

22 510 1490

22 510 1493

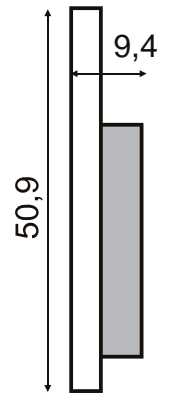
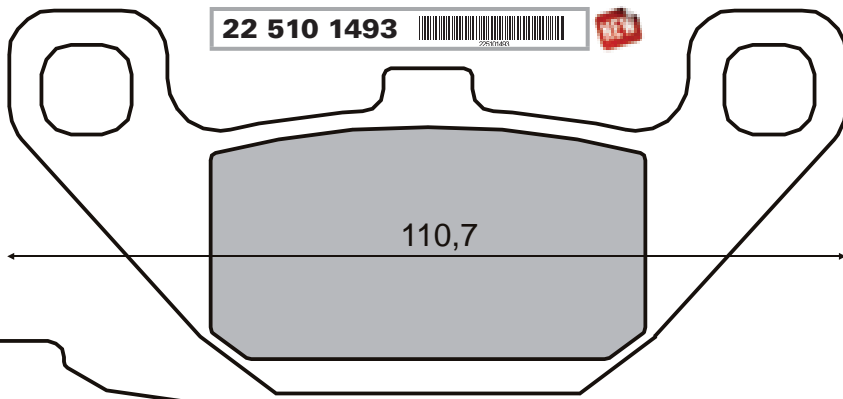
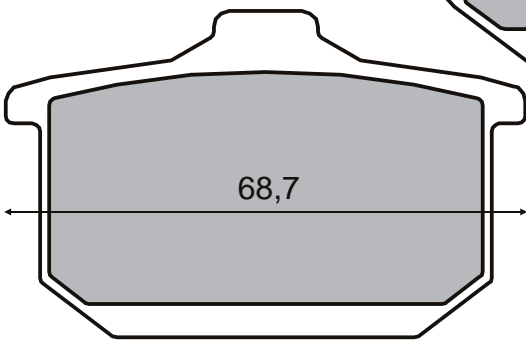
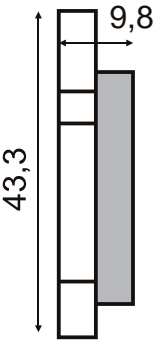

22 510 1500

22 510 1503

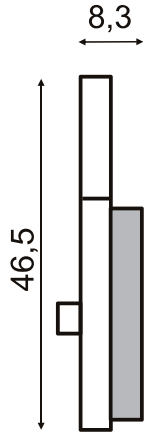
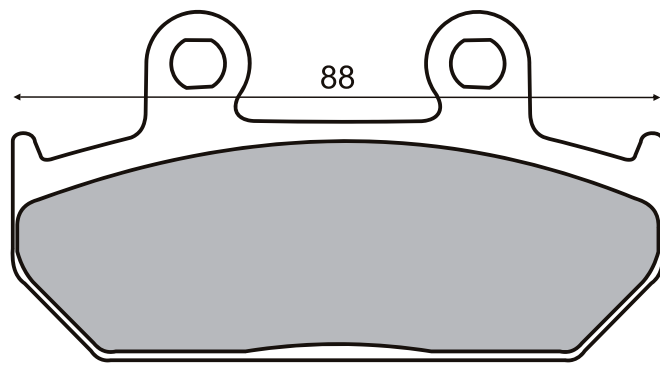

22 510 1603

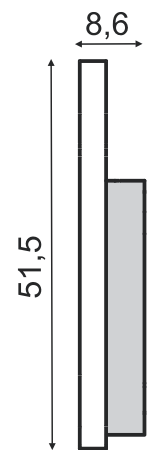
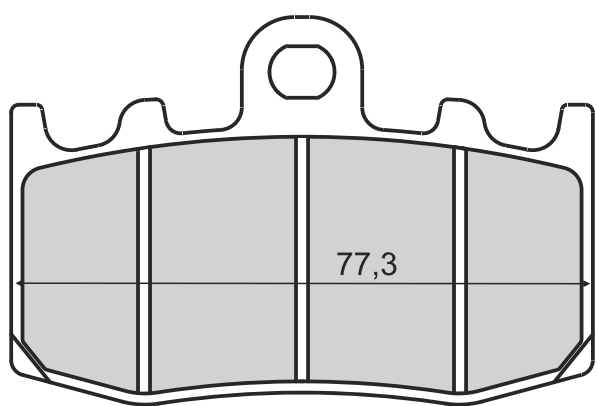

22 510 1620

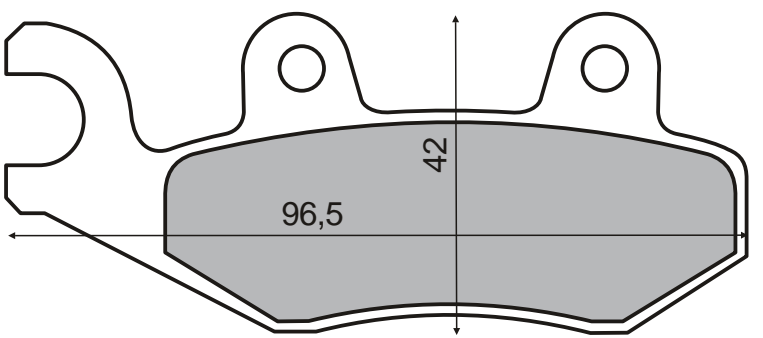
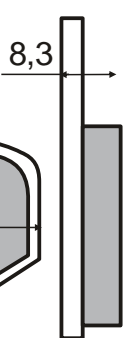
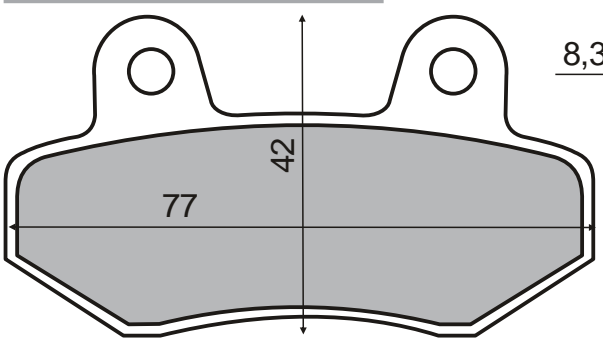

I codici con il numero 0 finale: **MESCOLA ORGANICA**
I codici con il numero 3 finale: **MESCOLA SINTERIZZATA**
■ Non omologata

PASTIGLIE FRENO IN ORDINE DI CODICE

BRAKE PADS SEARCH BY CODE NUMBER



22 510 1650

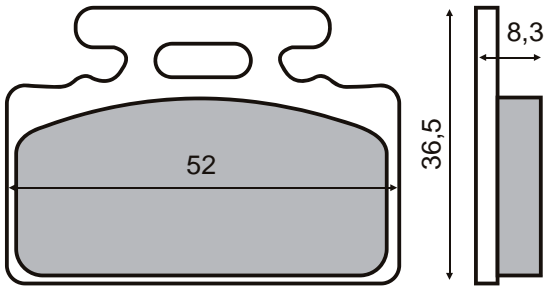

22 510 1790

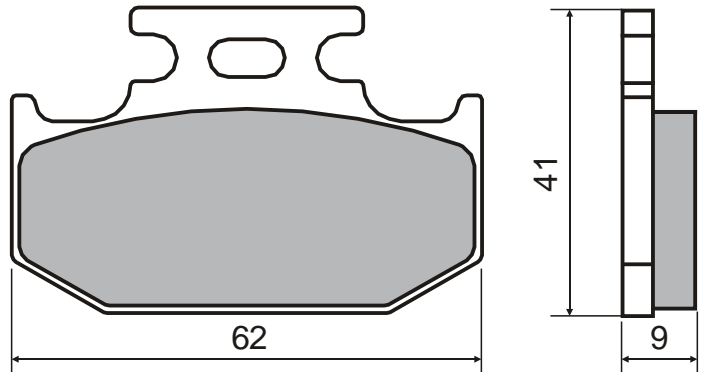

22 510 2020

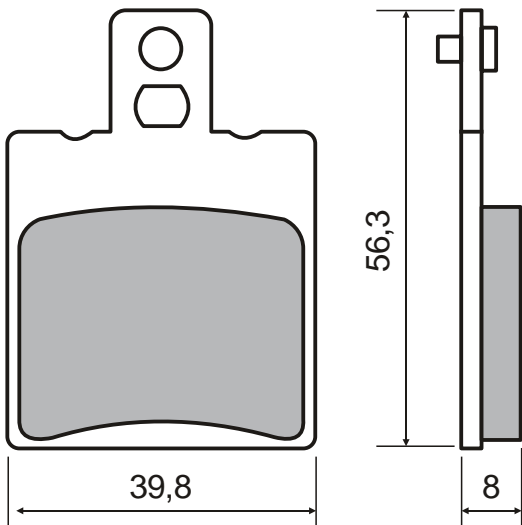

22 510 2120

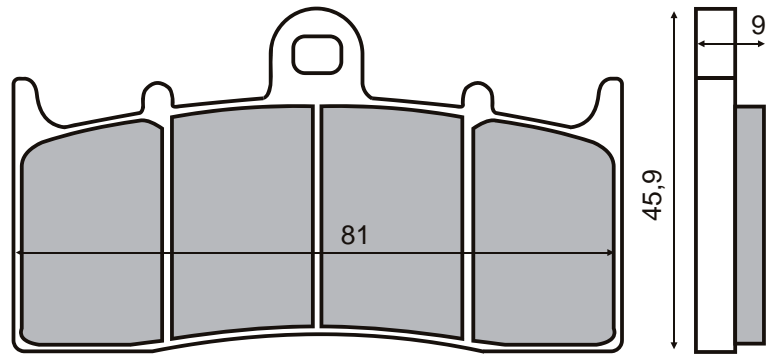

22 510 2530

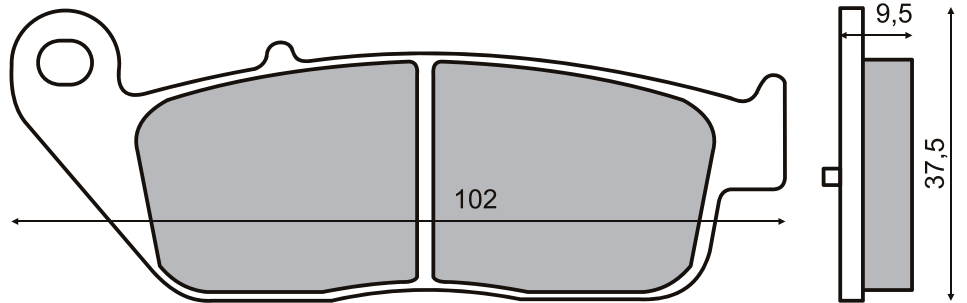

22 510 2540



22 510 2543

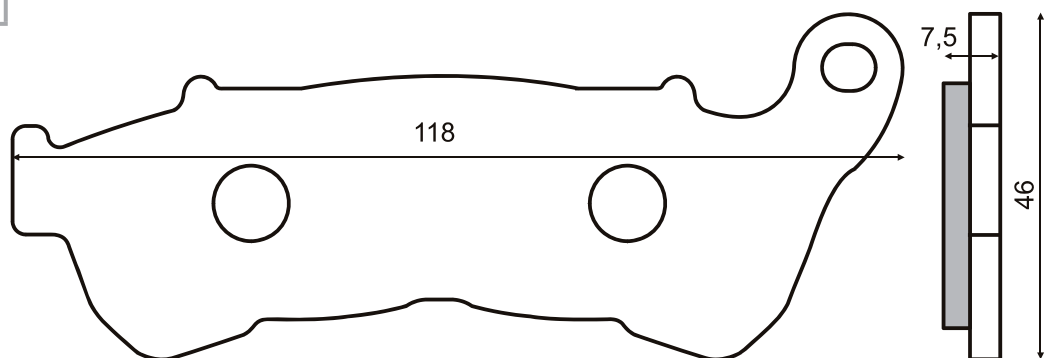



PASTIGLIE FRENO IN ORDINE DI CODICE
BRAKE PADS SEARCH BY CODE NUMBER

22 510 2550

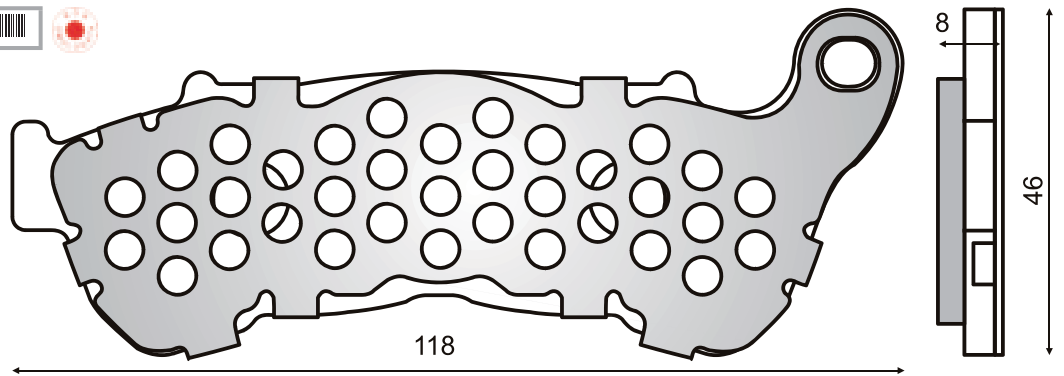

22 510 2560



22 510 2563

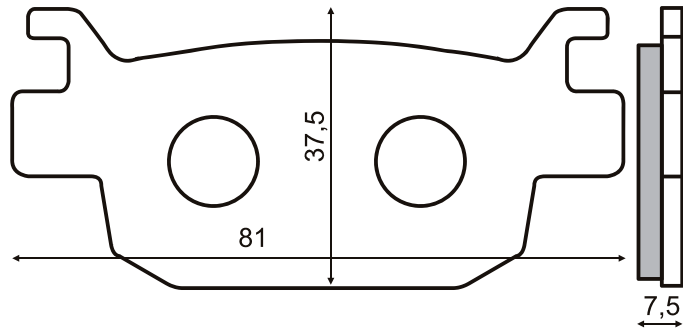

22 510 2570

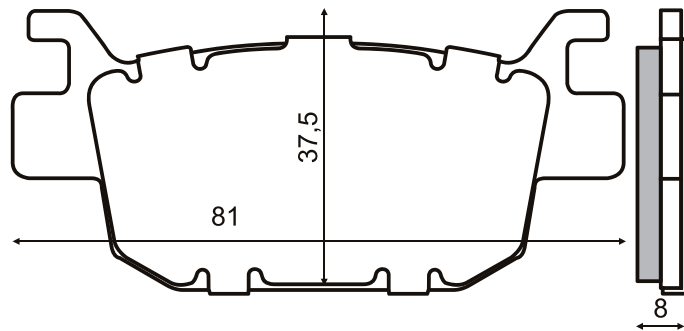

22 510 2590



22 510 2593

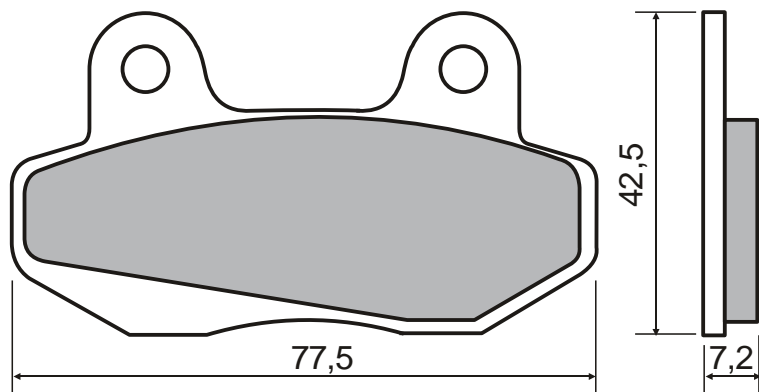

22 510 2600



22 510 2603

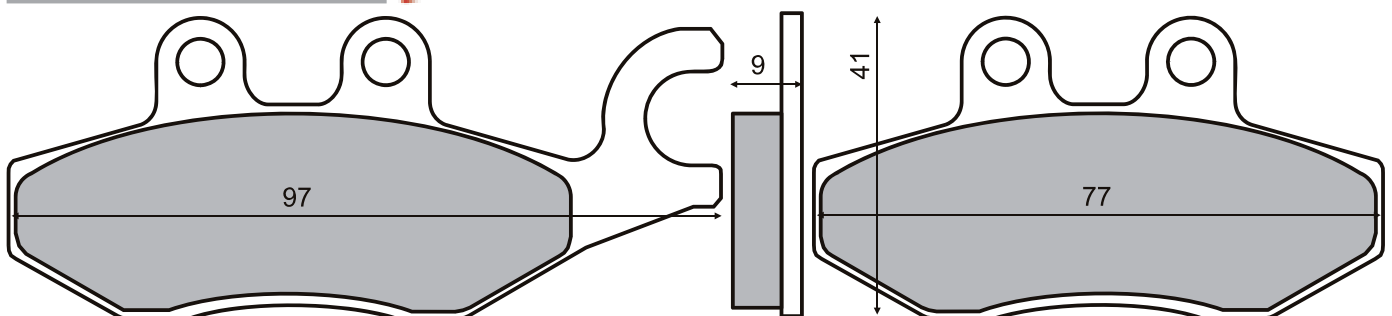

I codici con il numero 0 finale: **MESCOLA ORGANICA**
I codici con il numero 3 finale: **MESCOLA SINTERIZZATA**
Non omologata

PASTIGLIE FRENO IN ORDINE DI CODICE

BRAKE PADS SEARCH BY CODE NUMBER



22 510 2610 
22 510 2613 

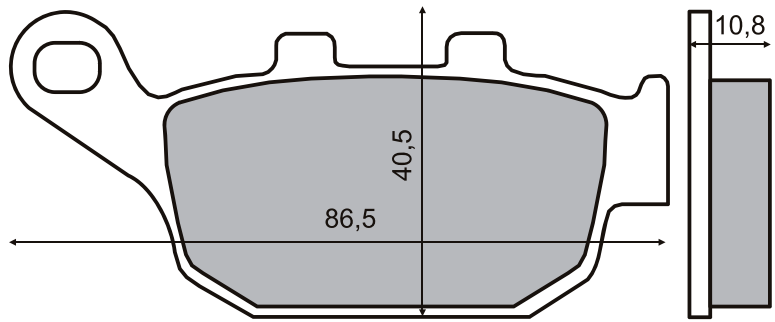

22 510 2620 
22 510 2623 

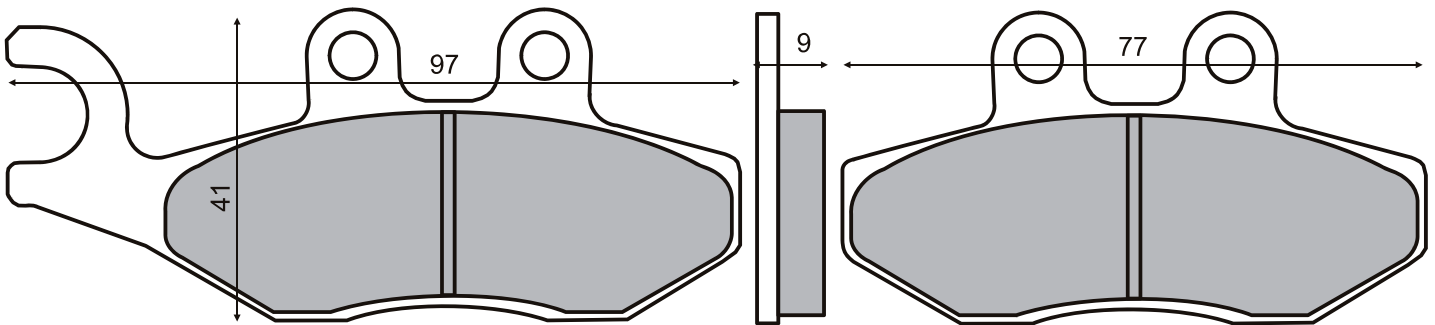

22 510 2630 
22 510 2633 

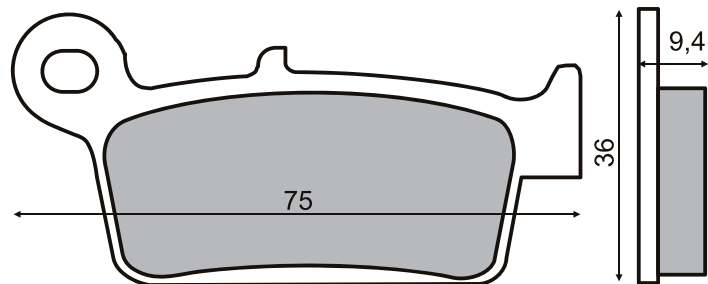

22 510 2640 
22 510 2643 

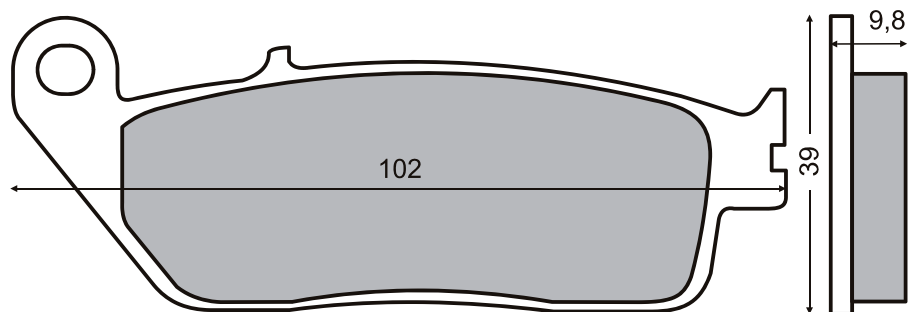

22 510 2650 
22 510 2653 

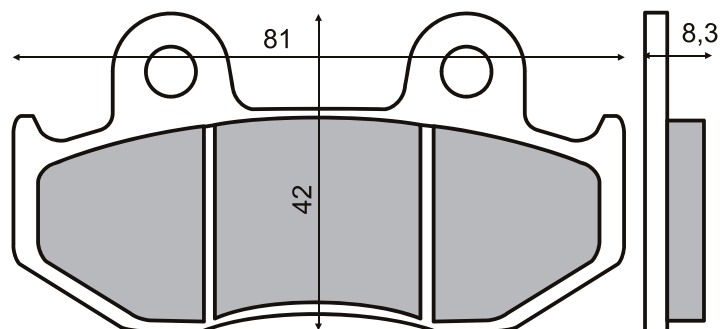



PASTIGLIE FRENO IN ORDINE DI CODICE

BRAKE PADS SEARCH BY CODE NUMBER

22 510 2660



22 510 2663

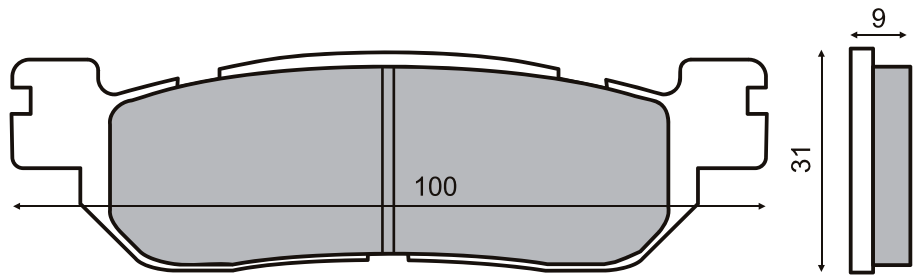

22 510 2670



22 510 0440



22 510 2673

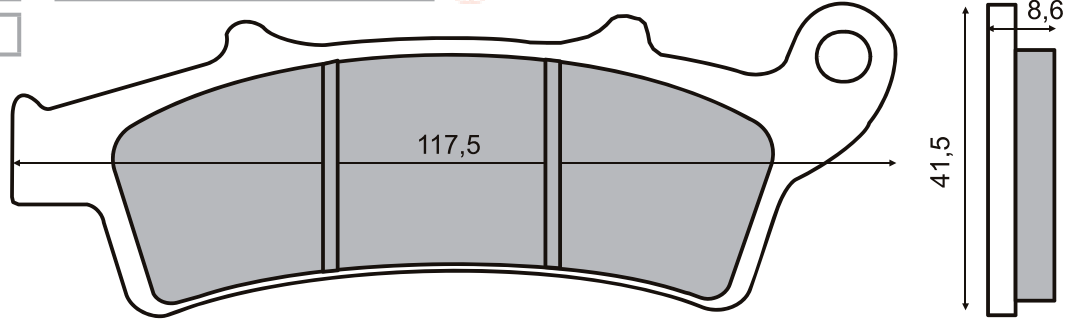

22 510 2710

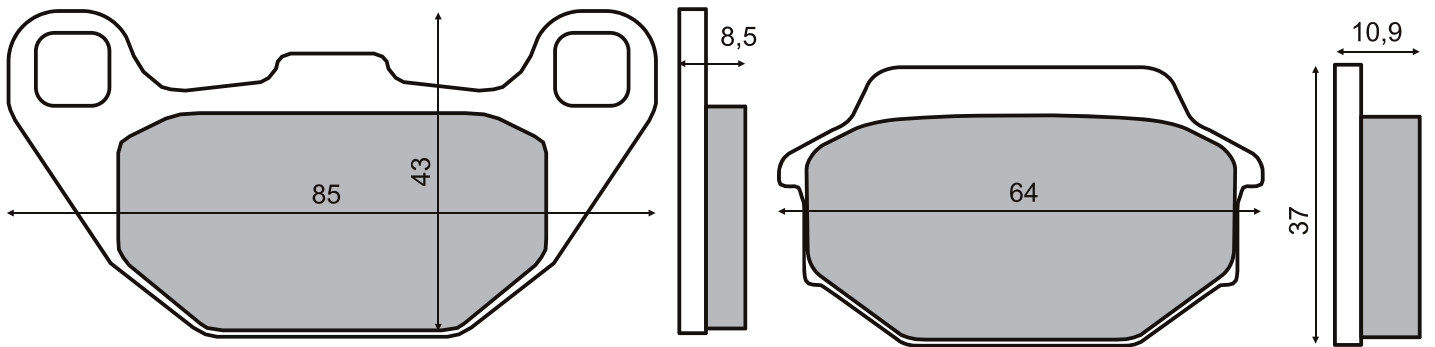

22 510 2720

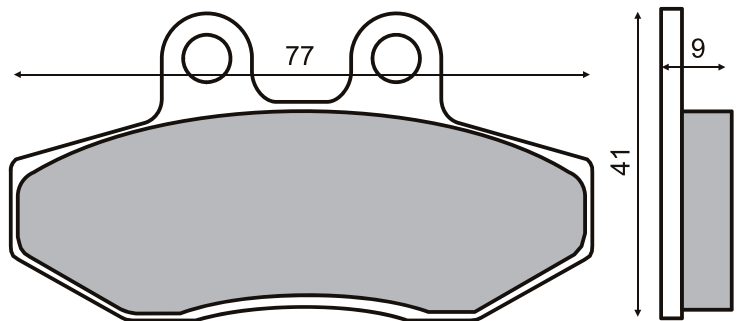

22 510 2730



22 510 1430

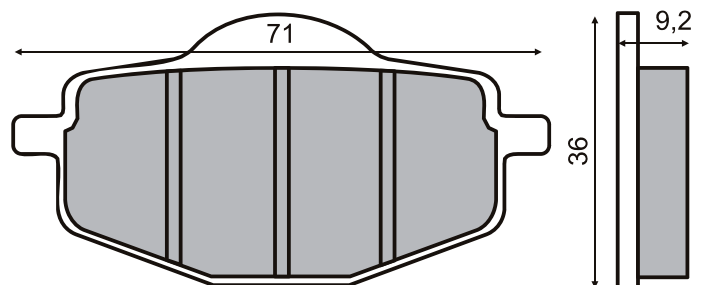



22 510 2740

22 510 2743

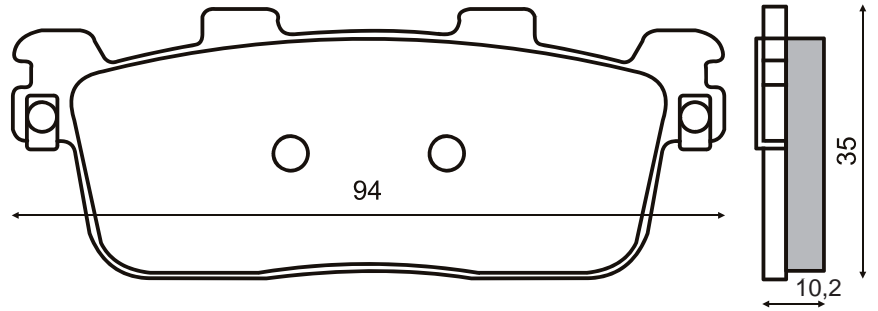

22 510 2750

22 510 2753

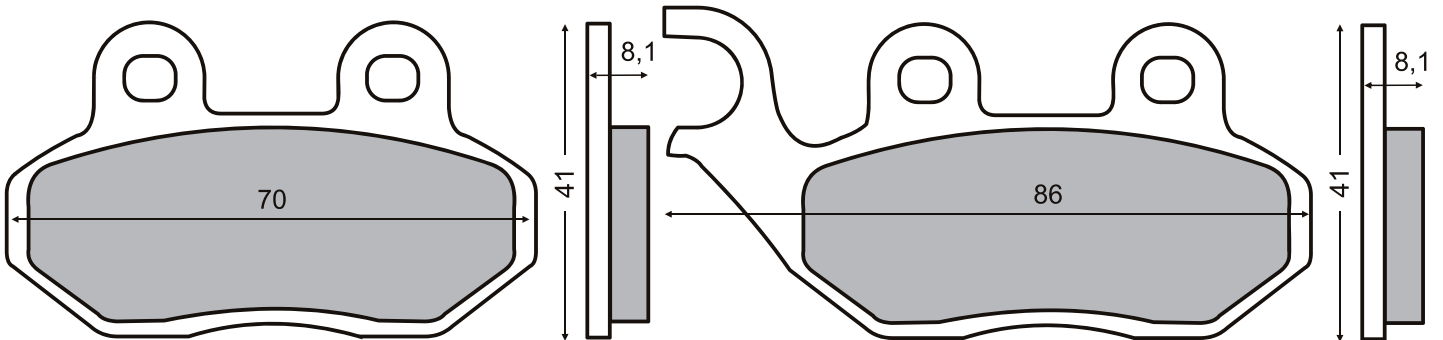

22 510 2760

22 510 2763

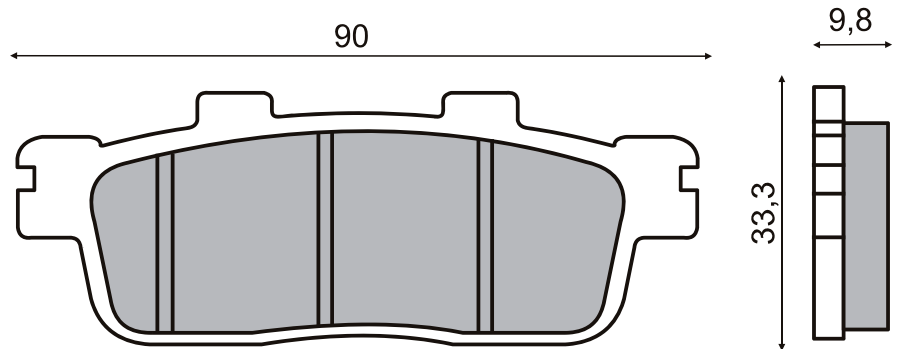

22 510 2780

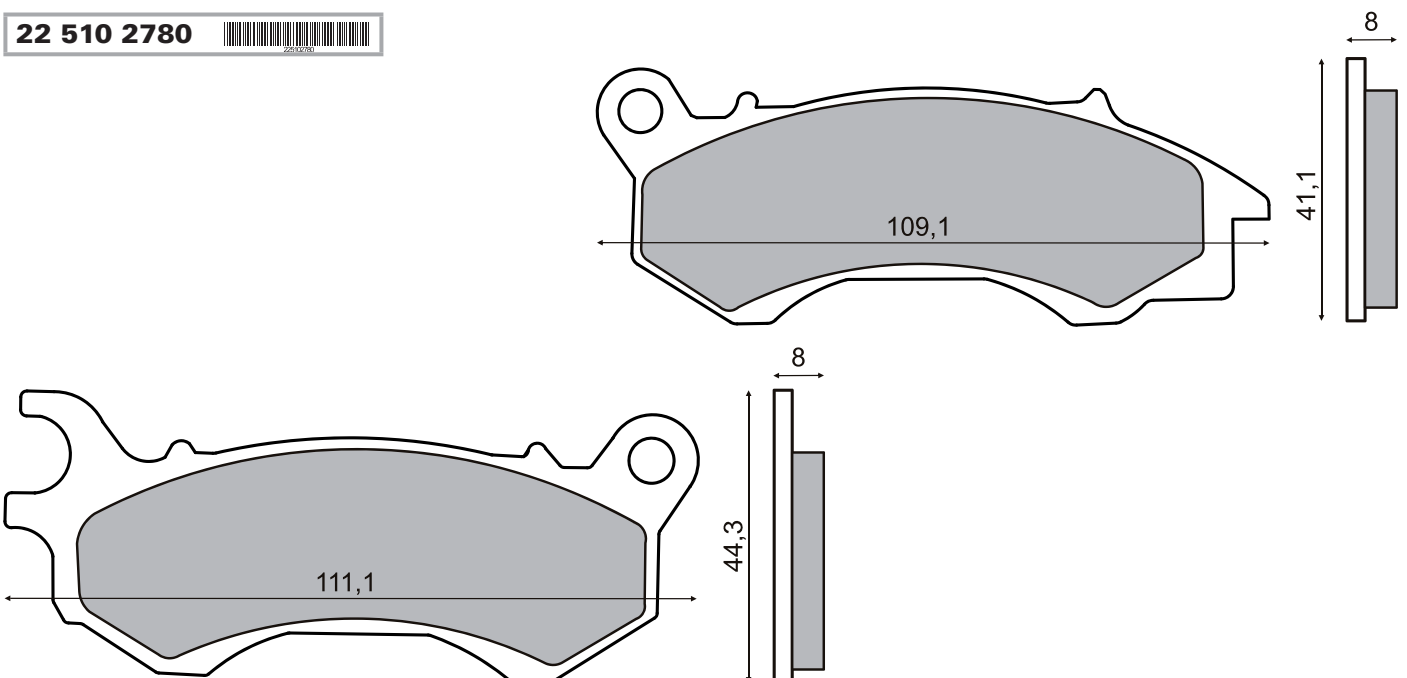



PASTIGLIE FRENO IN ORDINE DI CODICE
BRAKE PADS SEARCH BY CODE NUMBER

22 510 2800 

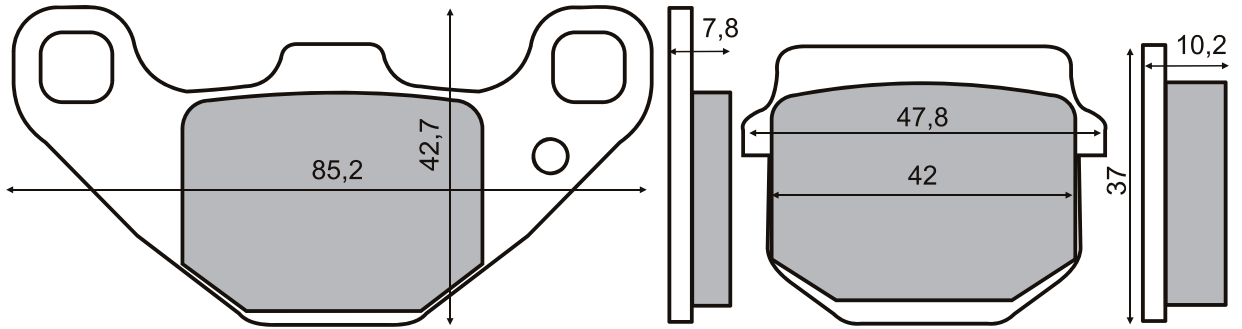

22 510 2810 

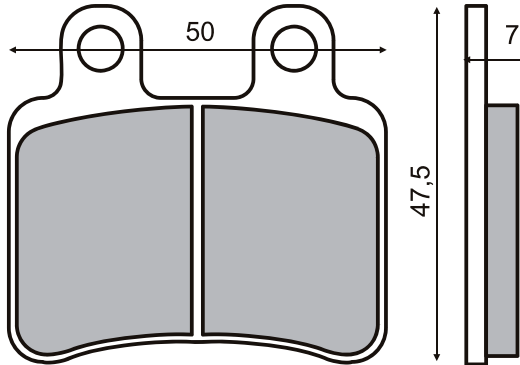

22 510 2820 

22 510 2823 

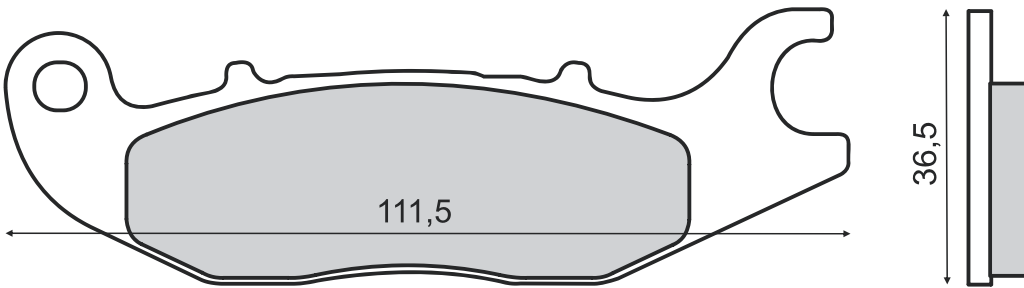
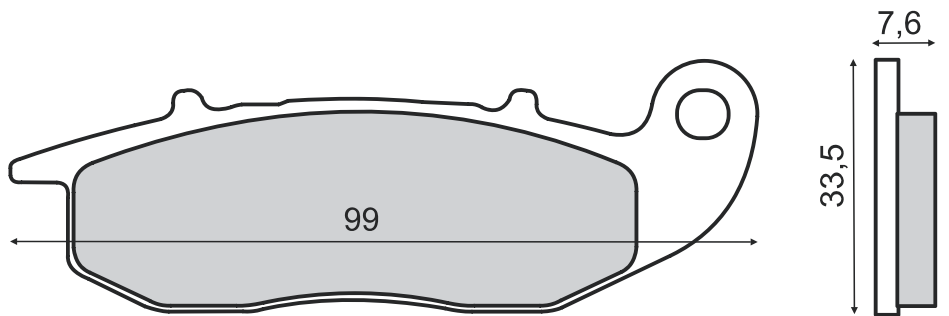

22 510 2830 

22 510 2833 

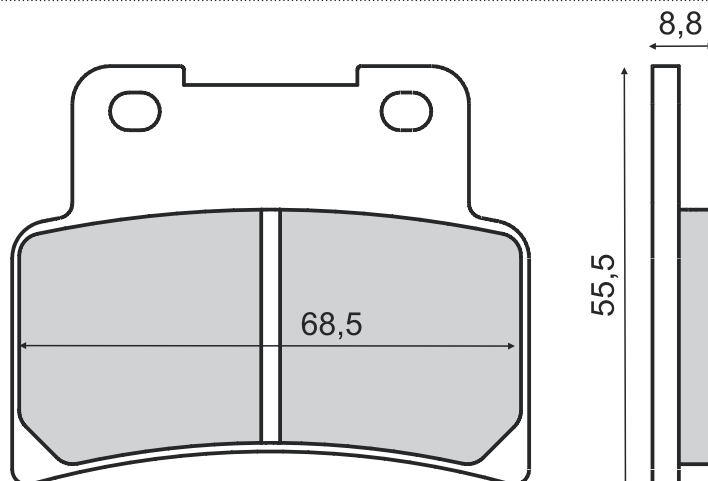

I codici con il numero 0 finale: **MESCOLA ORGANICA**
 I codici con il numero 3 finale: **MESCOLA SINTERIZZATA**
 Non omologata

PASTIGLIE FRENO IN ORDINE DI CODICE
BRAKE PADS SEARCH BY CODE NUMBER



22 510 2840

22 510 2843

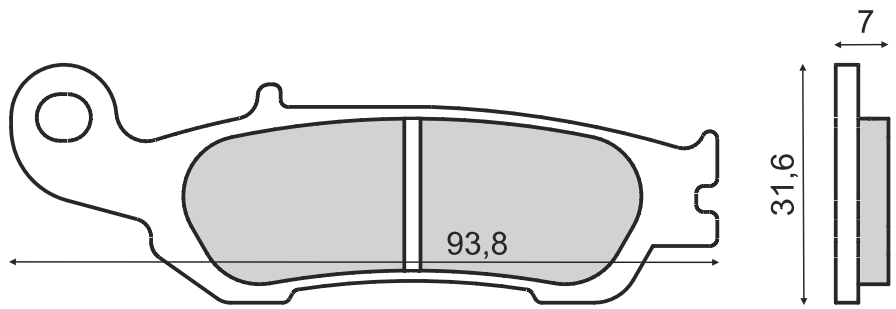

22 510 2850

22 510 2853

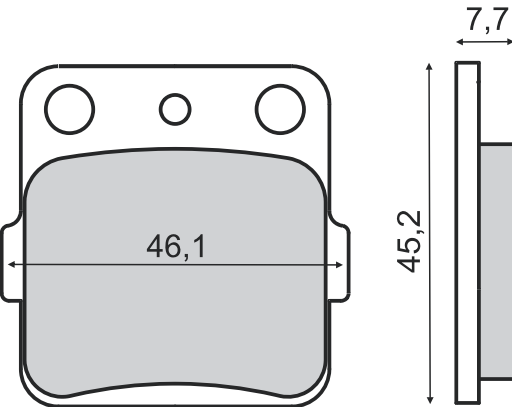

22 510 2860

22 510 2863

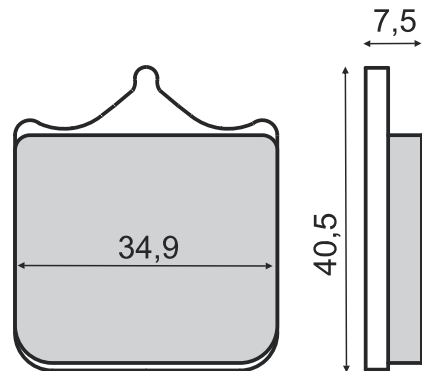

22 510 2870

22 510 2873

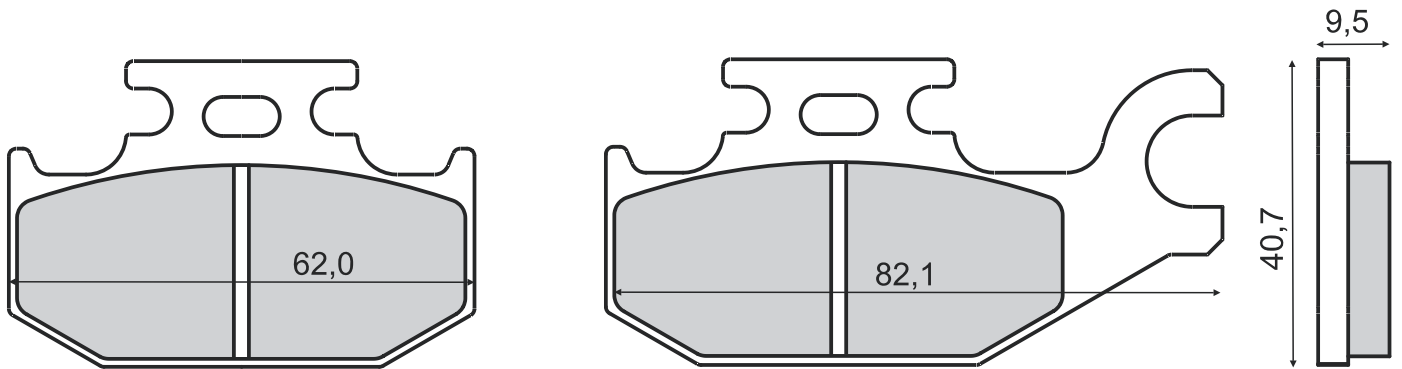

22 510 2880

22 510 2883

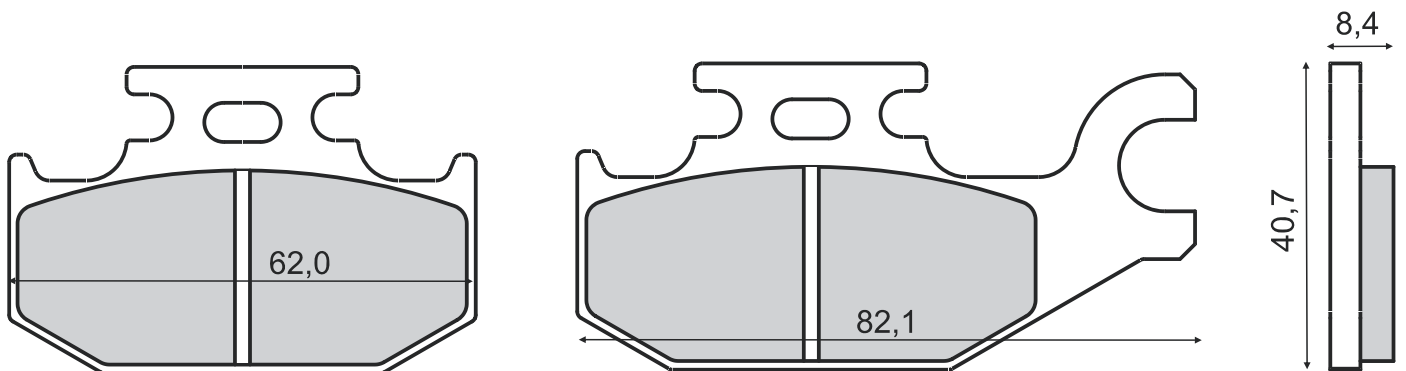



PASTIGLIE FRENO IN ORDINE DI CODICE

BRAKE PADS SEARCH BY CODE NUMBER

22 510 2890 

22 510 2893 

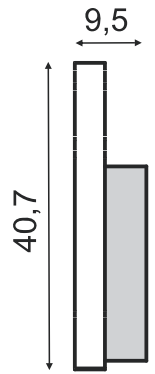
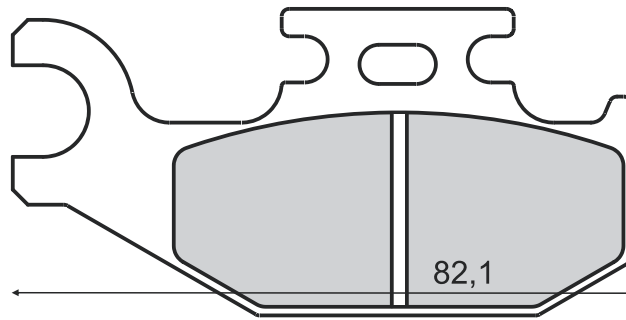
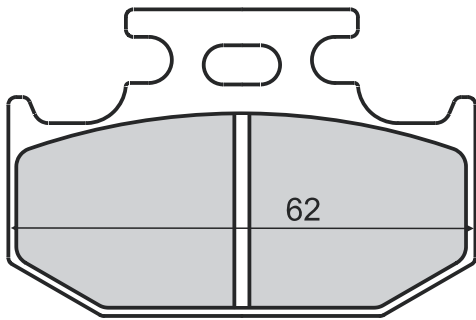

22 510 2900 

22 510 2903 

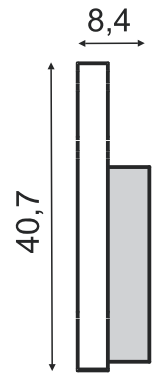
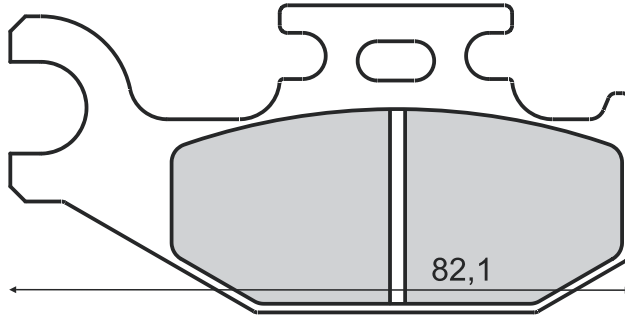
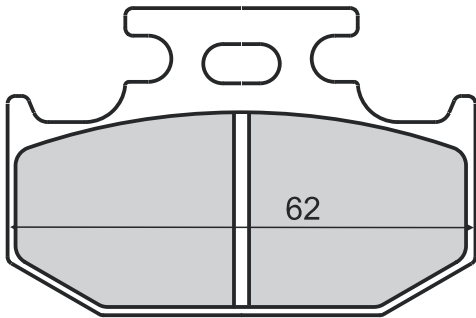

22 510 2910 

22 510 2913 

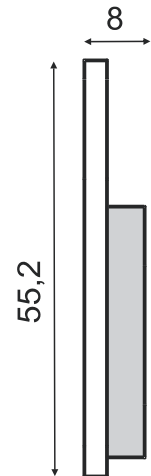
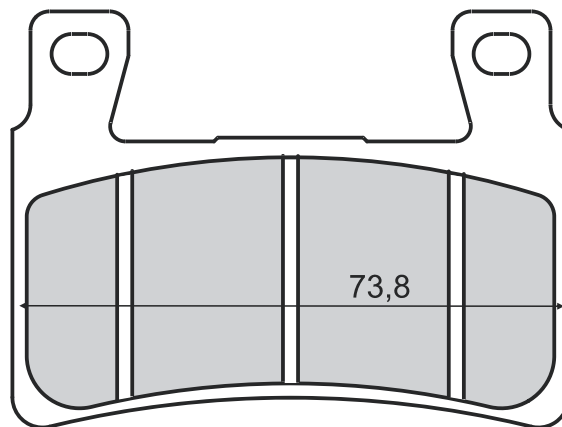

22 510 2923 

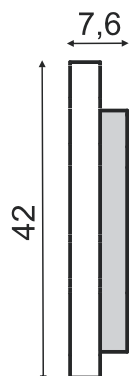
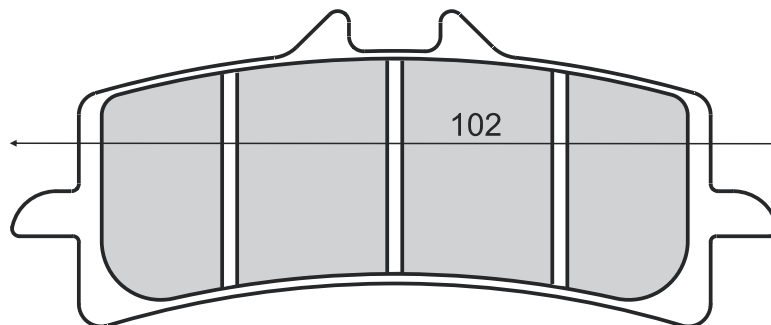

I codici con il numero 0 finale: **MESCOLA ORGANICA**
I codici con il numero 3 finale: **MESCOLA SINTERIZZATA**
+ Non omologata

PASTIGLIE FRENO IN ORDINE DI CODICE

BRAKE PADS SEARCH BY CODE NUMBER



22 510 2933

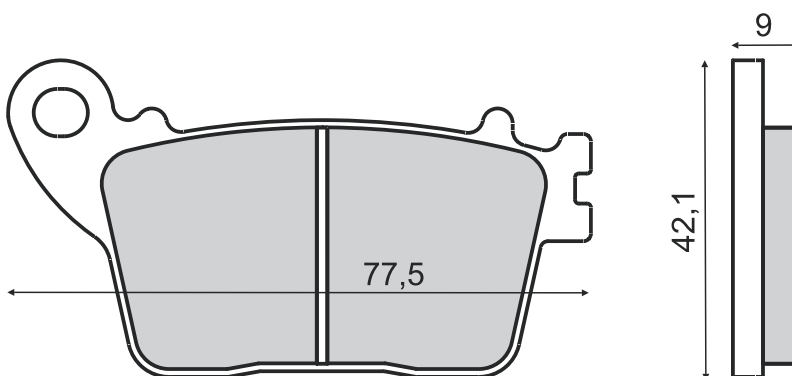

22 510 2943

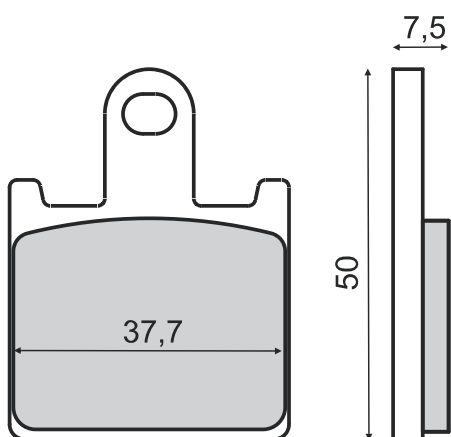

22 510 2950

22 510 2953

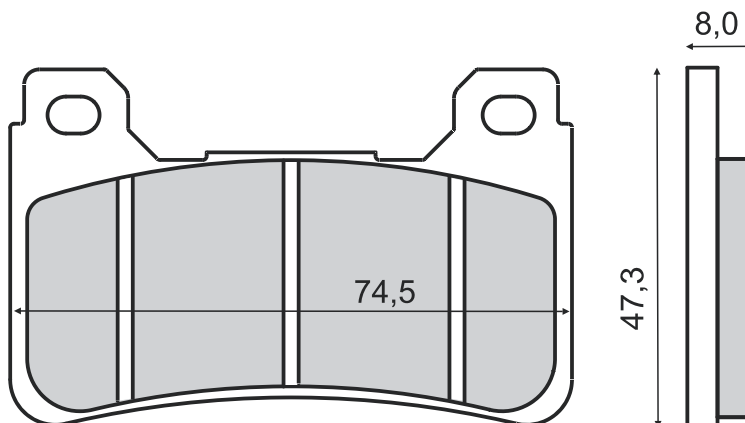

22 510 2960

22 510 2963

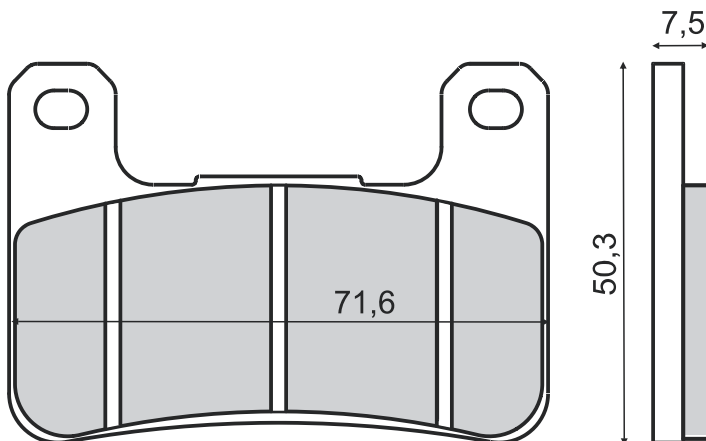

22 510 2973

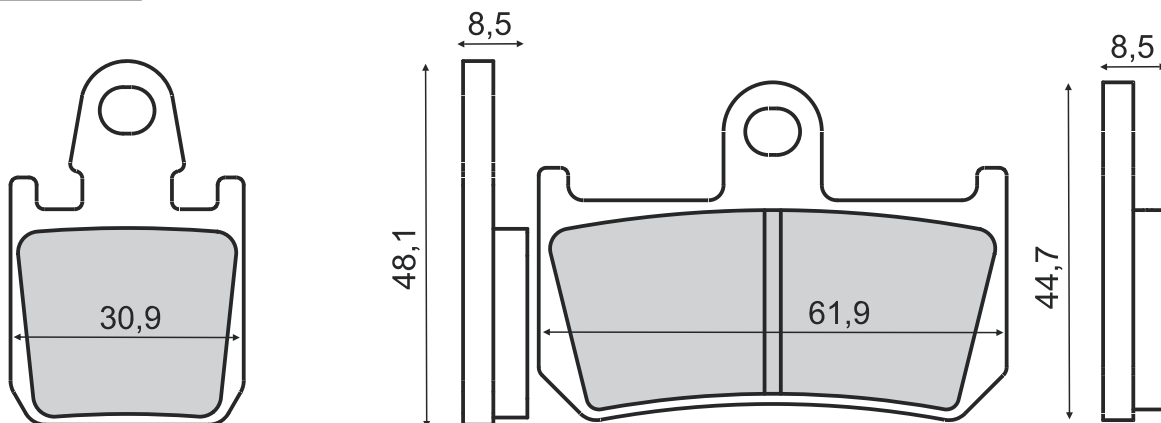



PASTIGLIE FRENO IN ORDINE DI CODICE
BRAKE PADS SEARCH BY CODE NUMBER

22 510 2983

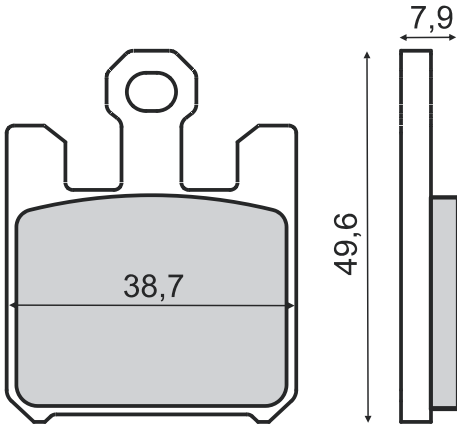

22 510 2993

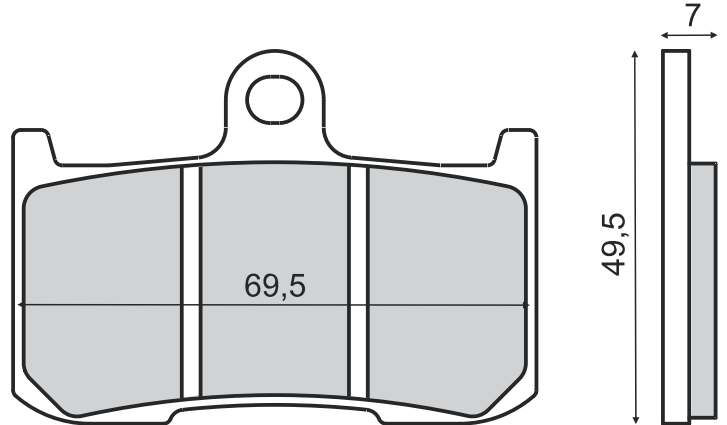

22 510 3003

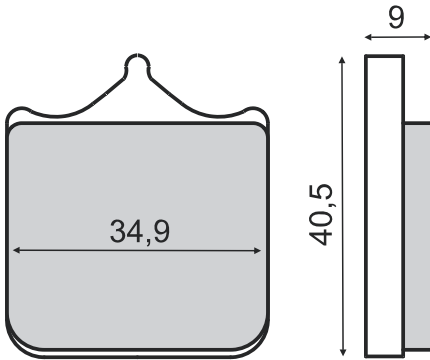

22 510 3013

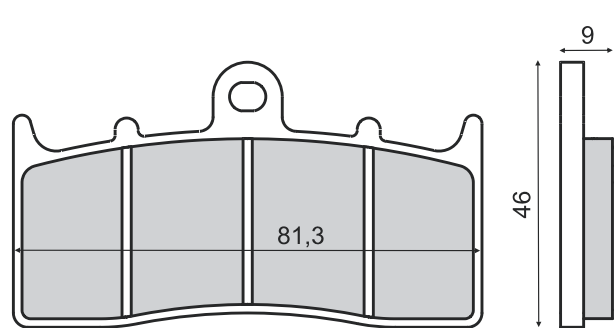

22 510 3020

22 510 3023

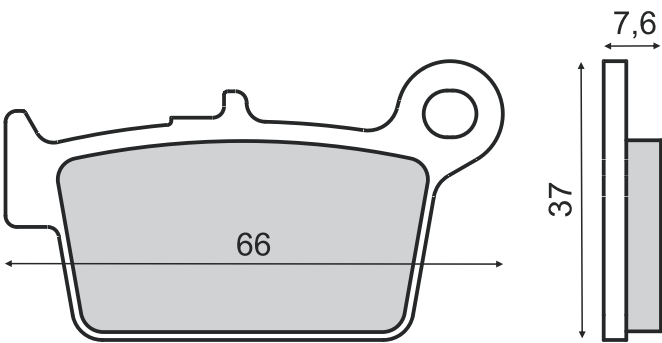

22 510 3030

22 510 3033

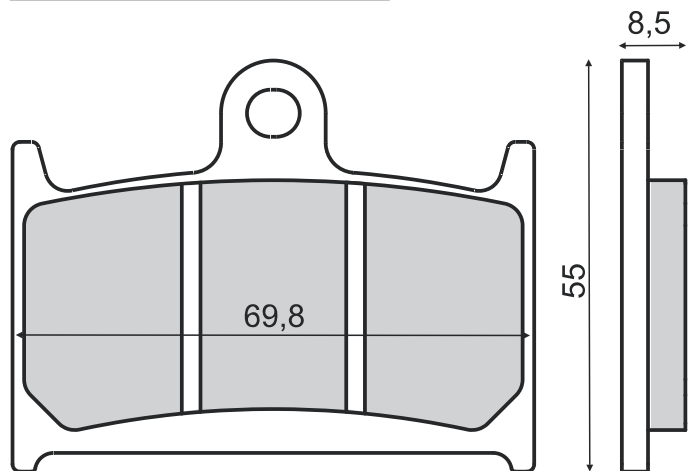

22 510 3043

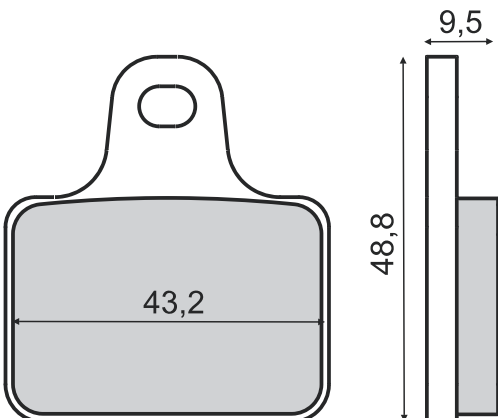

I codici con il numero 0 finale: **MESCOLA ORGANICA**
I codici con il numero 3 finale: **MESCOLA SINTERIZZATA**
Non omologata

PASTIGLIE FRENO IN ORDINE DI CODICE

BRAKE PADS SEARCH BY CODE NUMBER



22 510 3050 

22 510 3053 

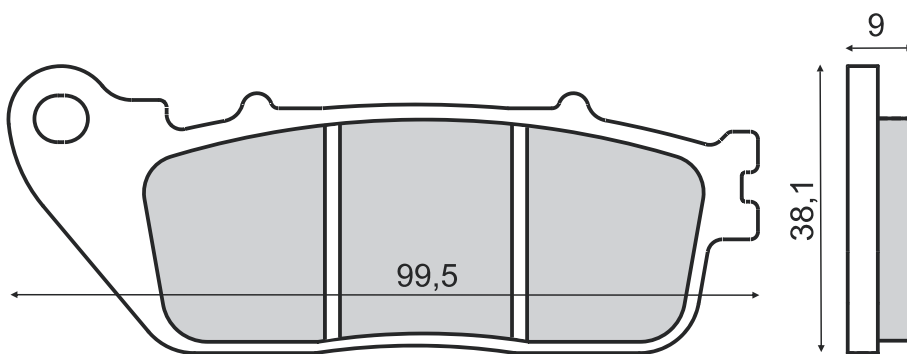

22 510 3060 

22 510 3063 

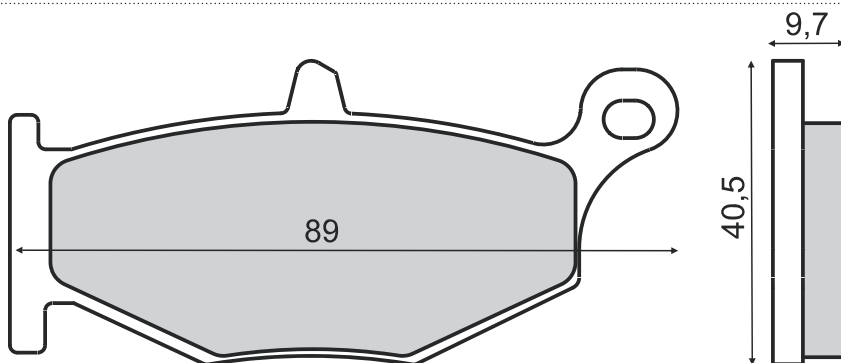

22 510 3070 

22 510 3073 

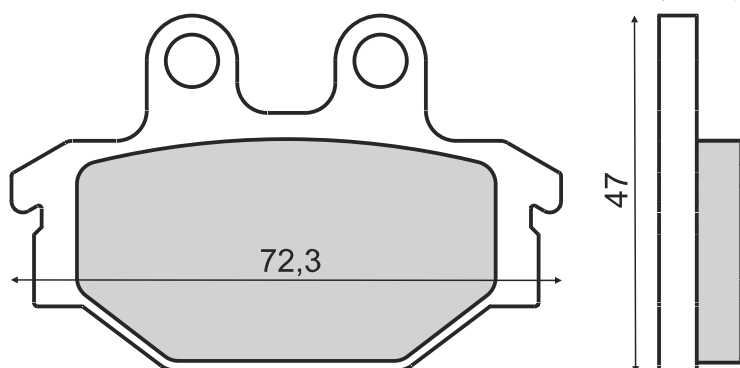
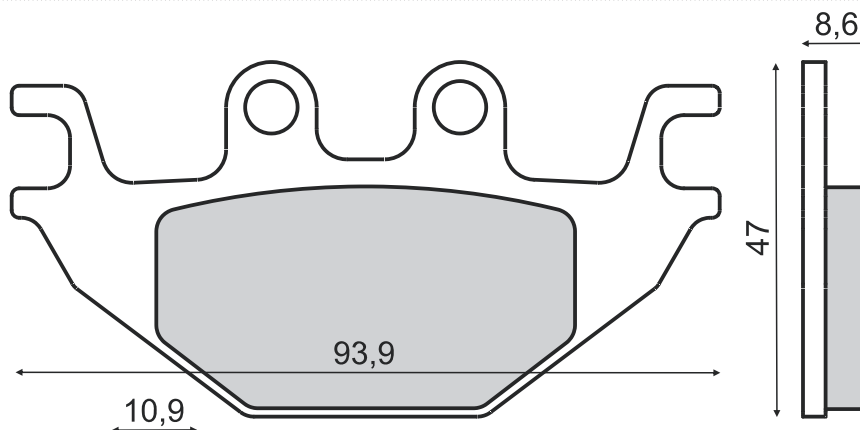

22 510 3080 

22 510 3083 

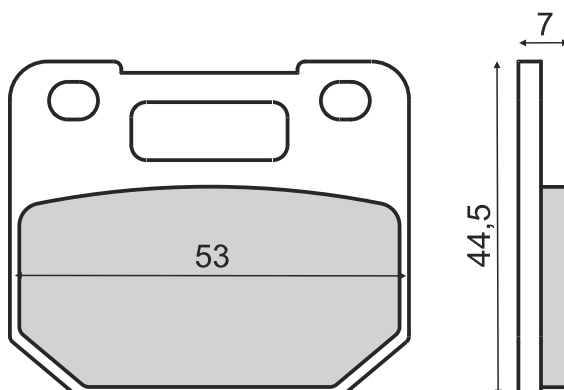



PASTIGLIE FRENO IN ORDINE DI CODICE

BRAKE PADS SEARCH BY CODE NUMBER

22 510 3093 

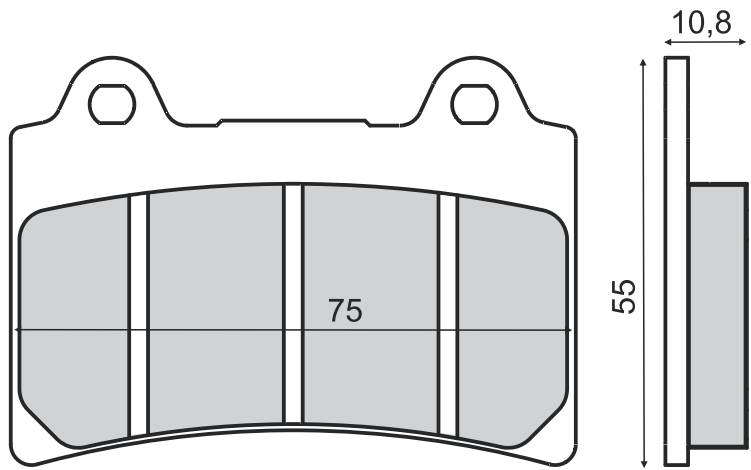

22 510 3103 

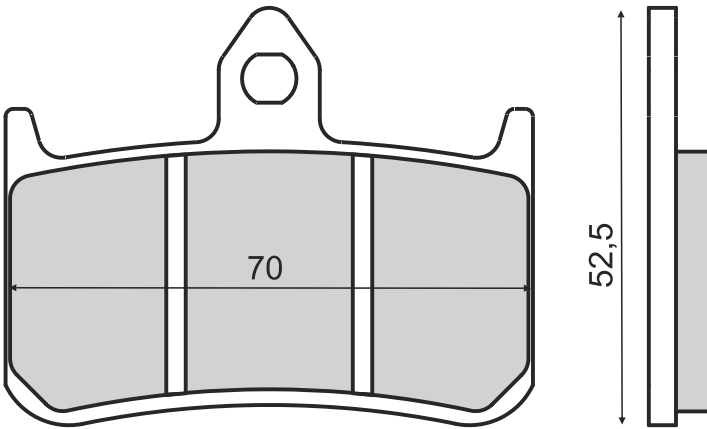

22 510 3110 

22 510 3113 

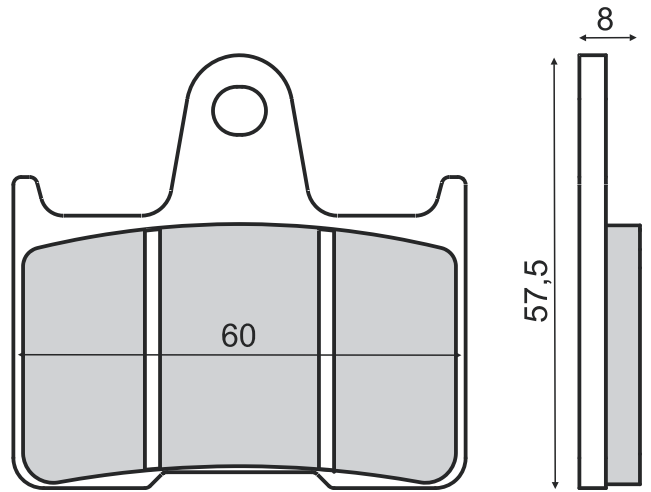

22 510 3123 

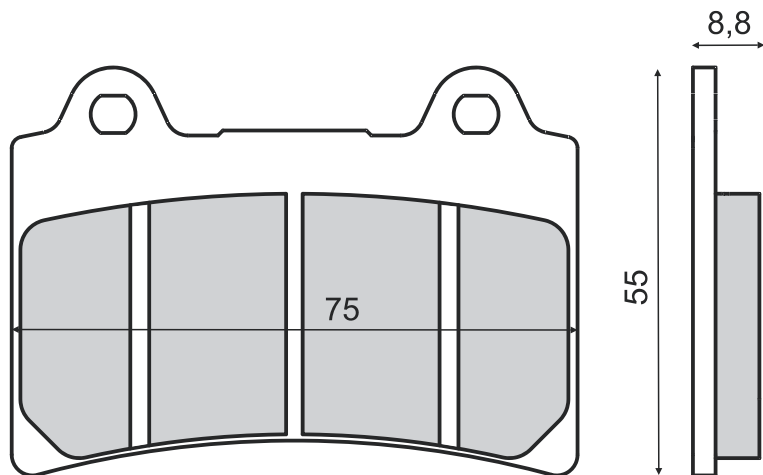

22 510 3130 

22 510 3133 

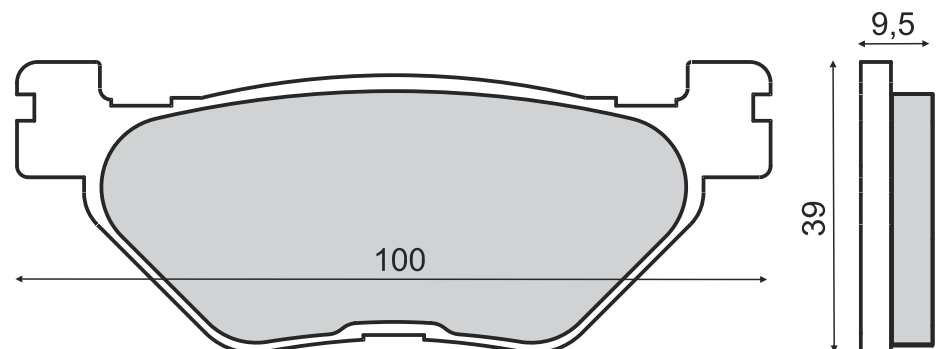

I codici con il numero 0 finale: **MESCOLA ORGANICA**
I codici con il numero 3 finale: **MESCOLA SINTERIZZATA**
■ Non omologata

PASTIGLIE FRENO IN ORDINE DI CODICE

BRAKE PADS SEARCH BY CODE NUMBER



22 510 3140

22 510 3143

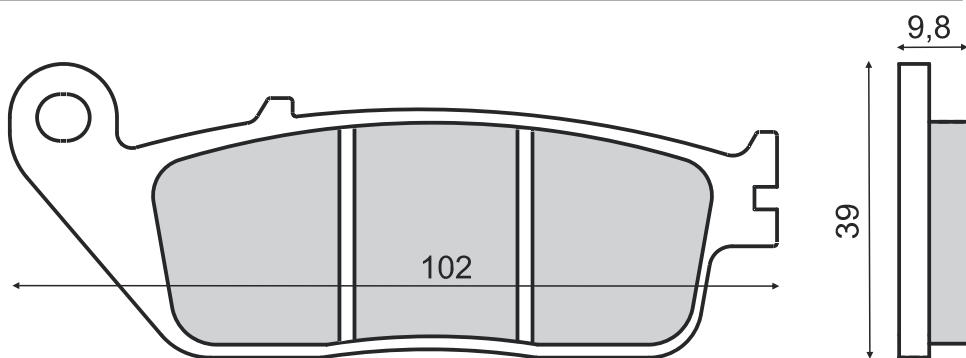

22 510 3150

22 510 3153

22 510 3160

22 510 3163

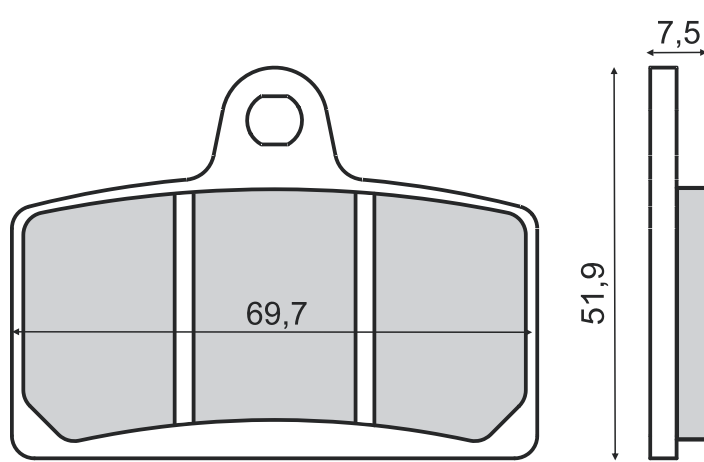
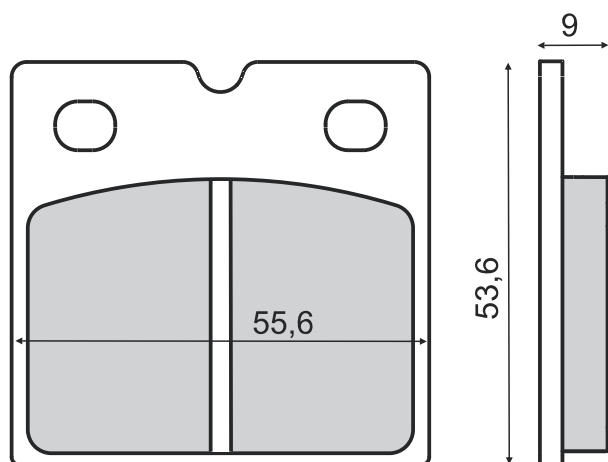

22 510 3170

22 510 3173

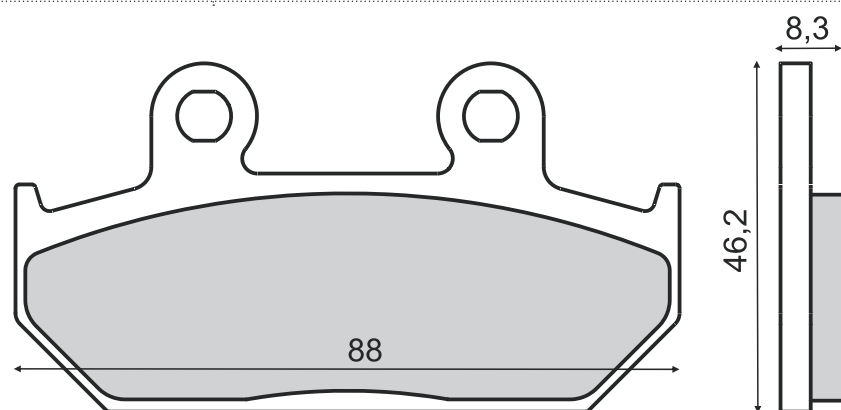

22 510 3180

22 510 3183

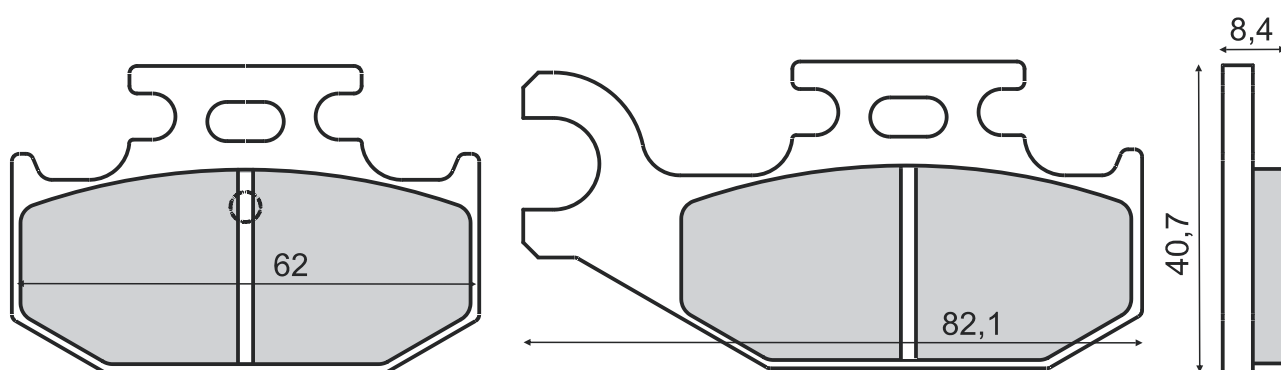



PASTIGLIE FRENO IN ORDINE DI CODICE

BRAKE PADS SEARCH BY CODE NUMBER

22 510 3193 

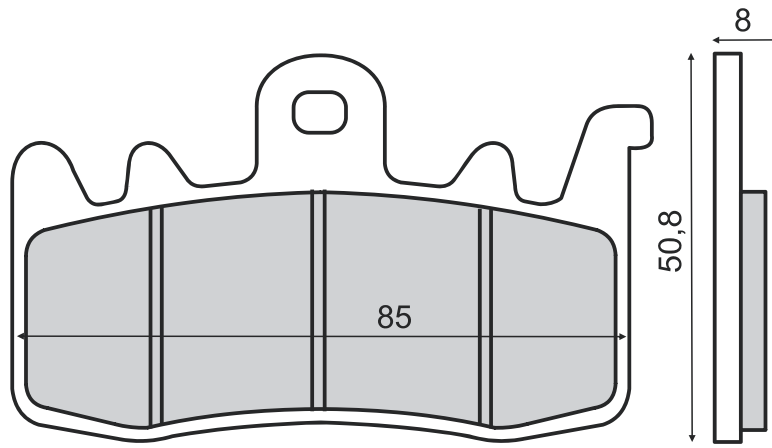

22 510 3200 

22 510 3203 

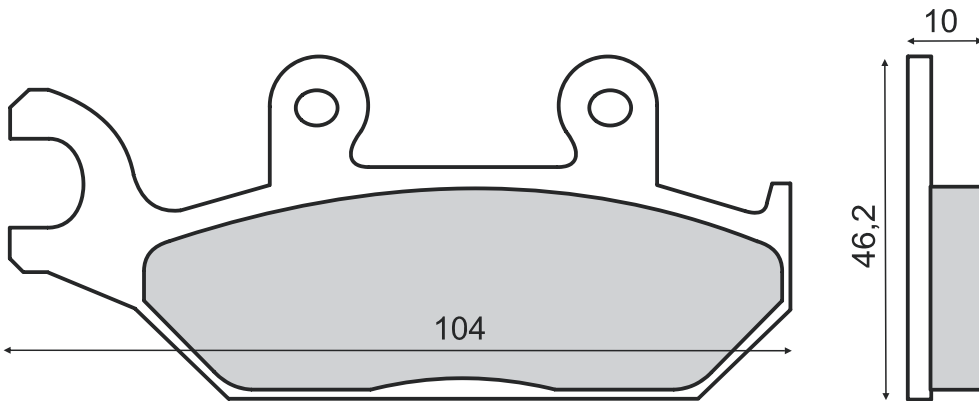
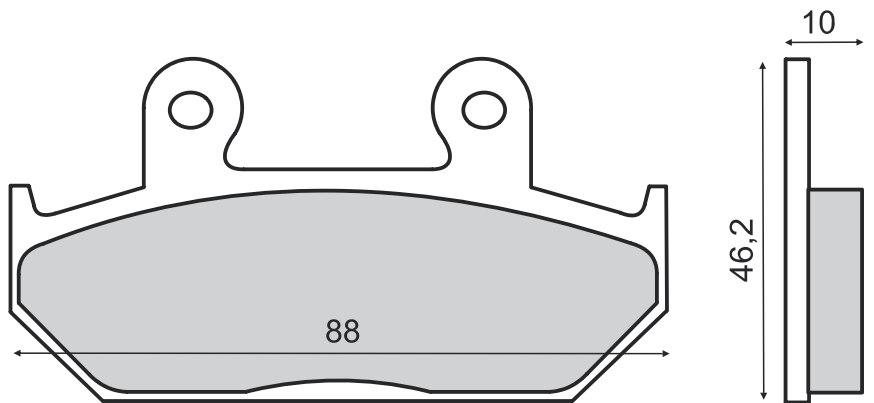

22 510 3210 

22 510 3220 

22 510 3223 

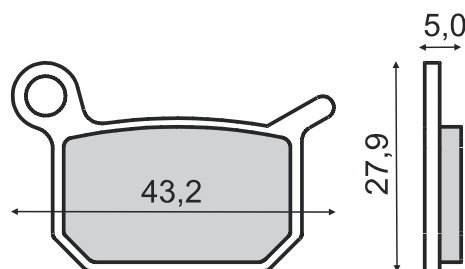
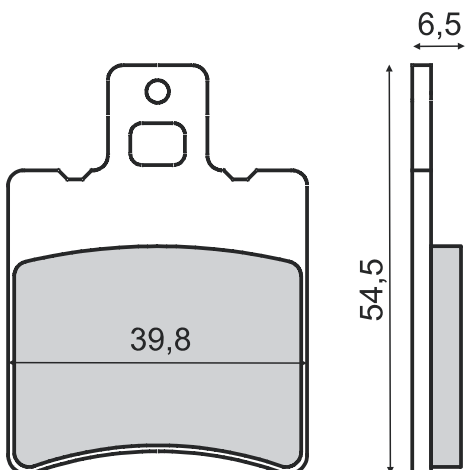



22 510 3230 

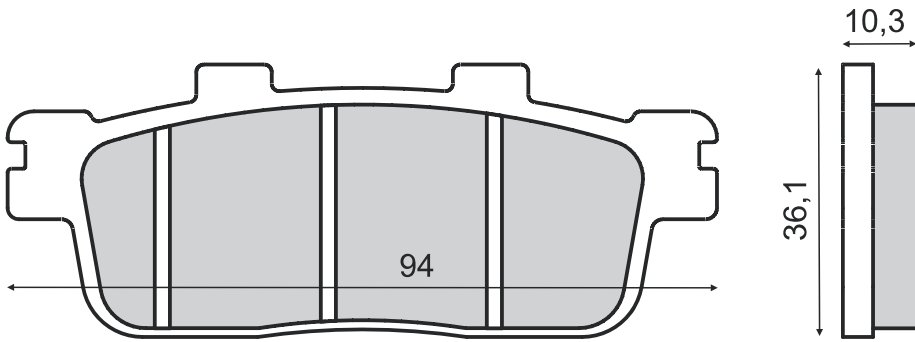

22 510 3240 

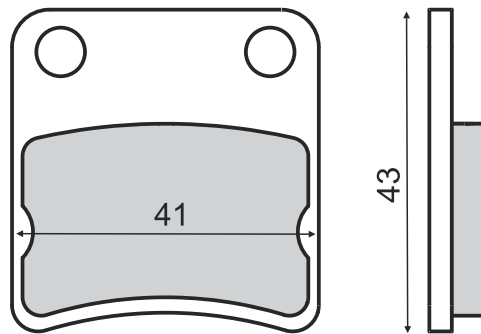

22 510 3250 

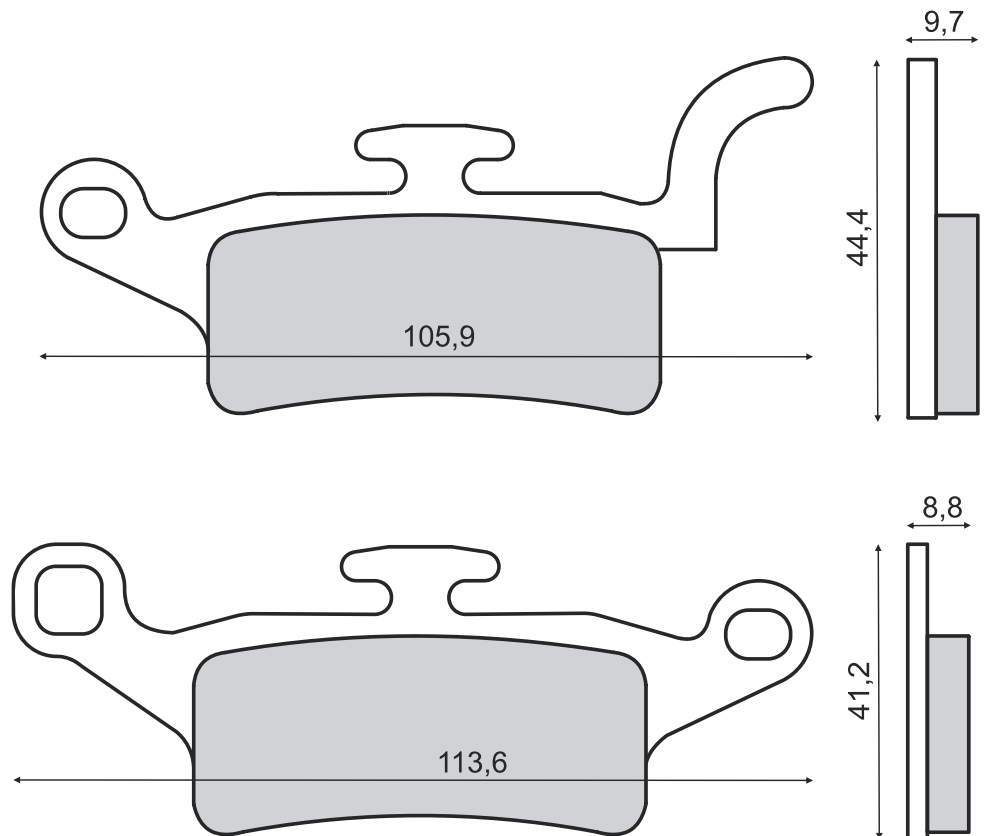



PASTIGLIE FRENO IN ORDINE DI CODICE
BRAKE PADS SEARCH BY CODE NUMBER

22 510 3260

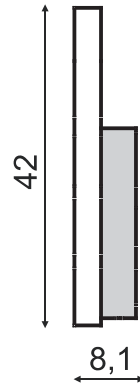
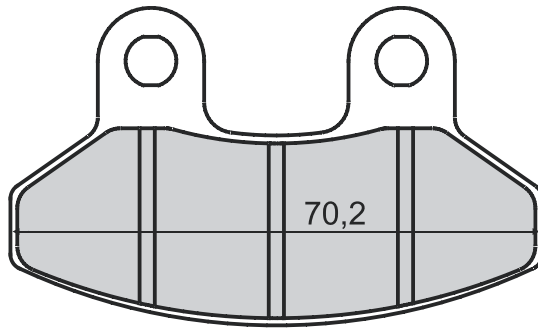

22 510 3270



22 510 3273

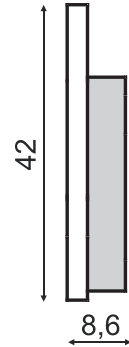
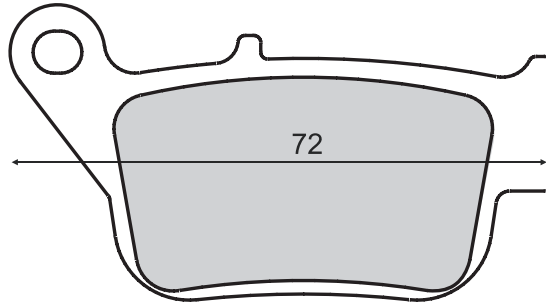

22 510 3280



22 510 3283

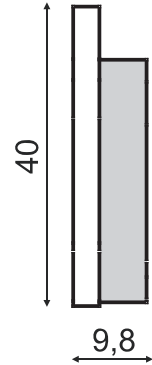
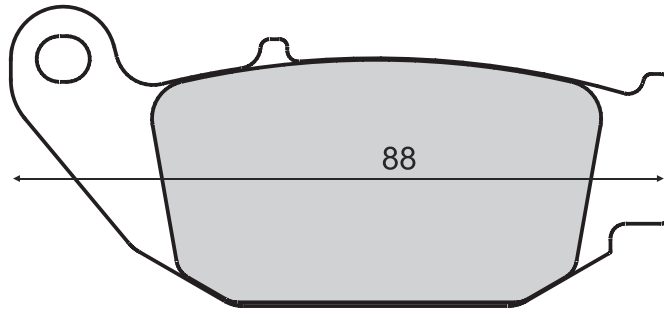

22 510 3290

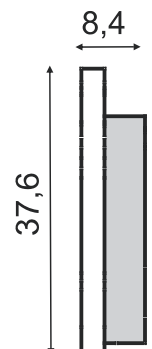
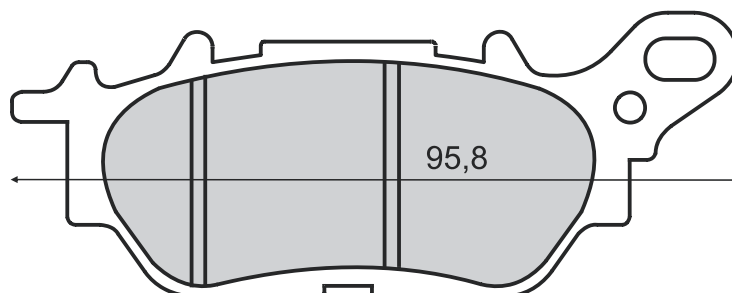
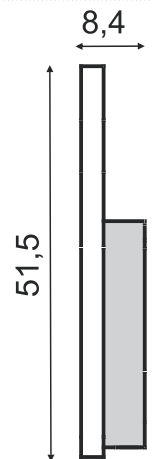
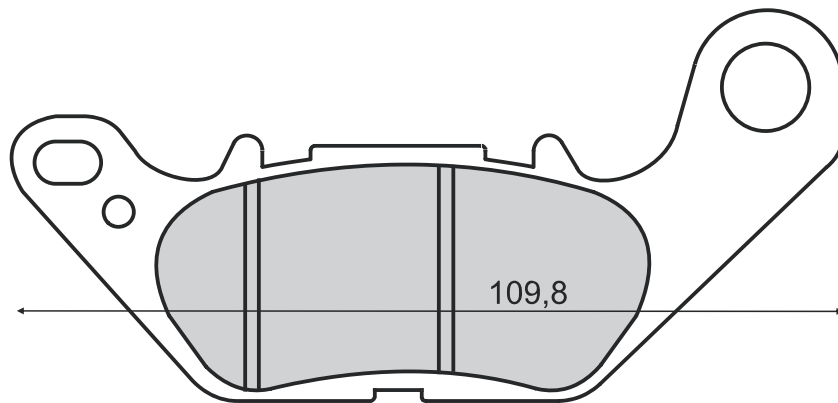



22 510 3300

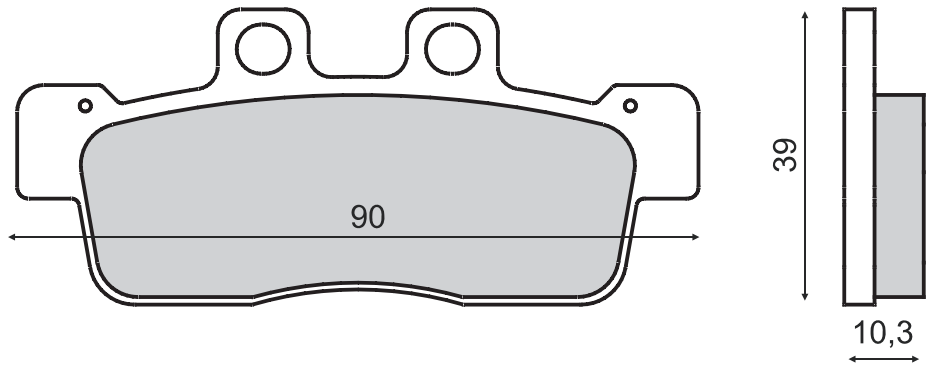

22 510 3310

22 510 3313

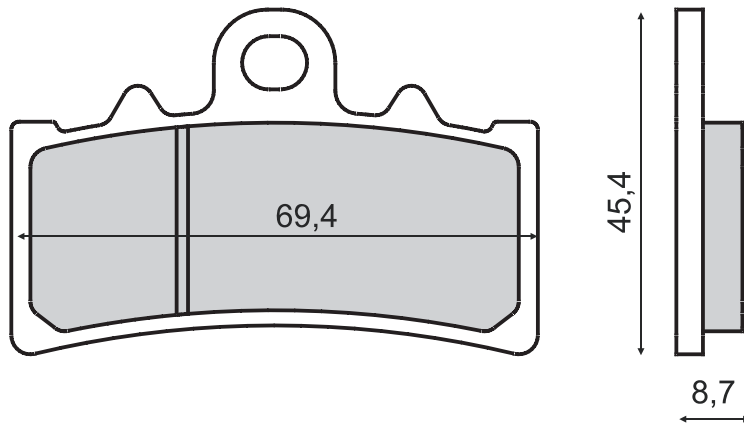

22 510 3323

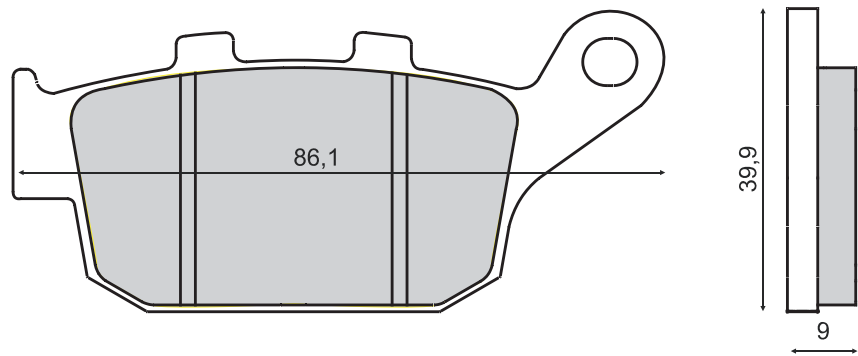

22 510 3333

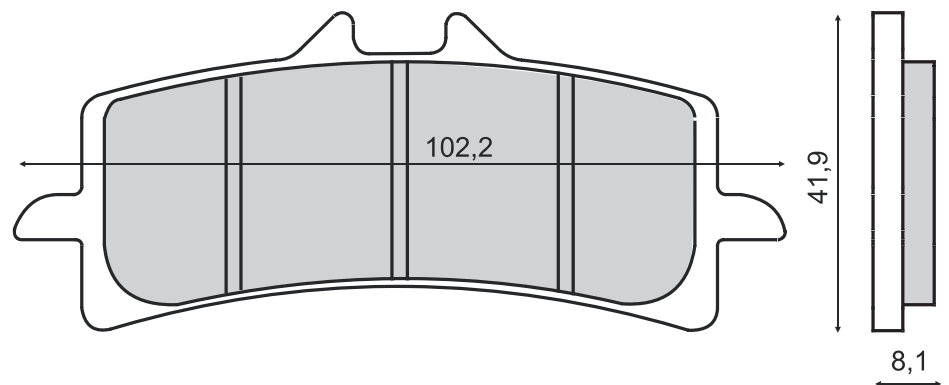



PASTIGLIE FRENO IN ORDINE DI CODICE

BRAKE PADS SEARCH BY CODE NUMBER

22 510 3343

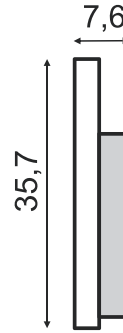
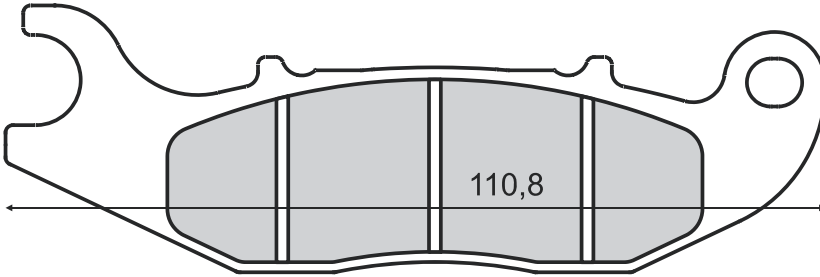
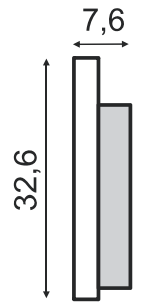
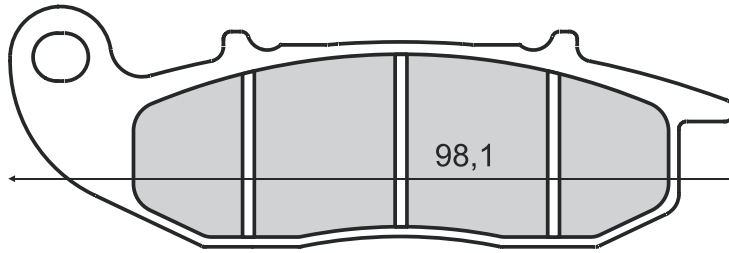

22 510 3353

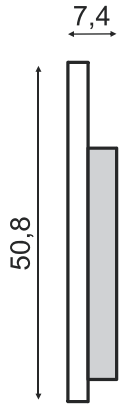
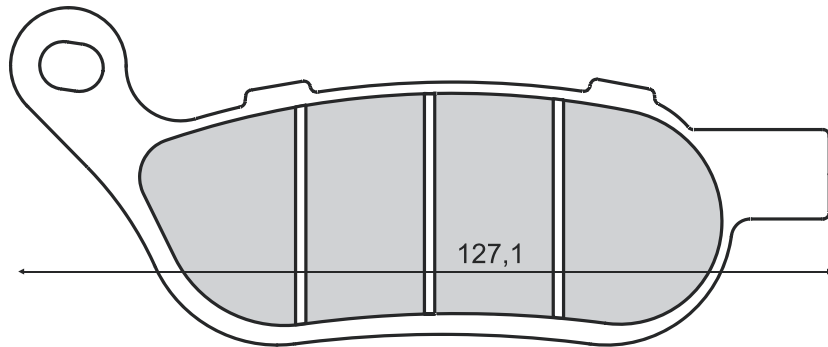

22 510 3363

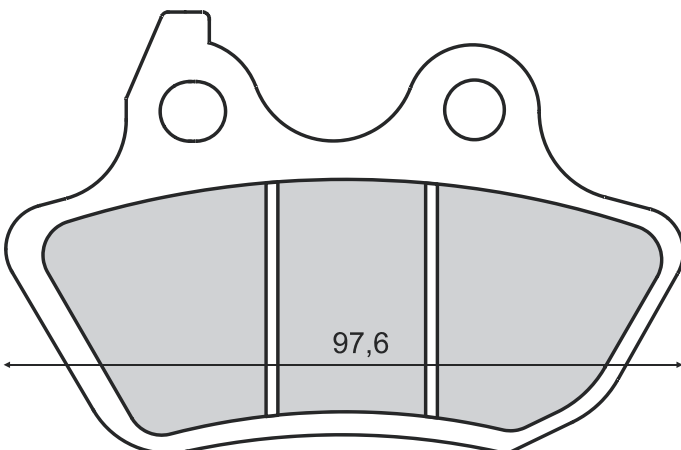
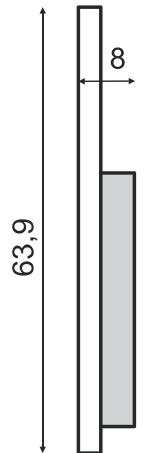
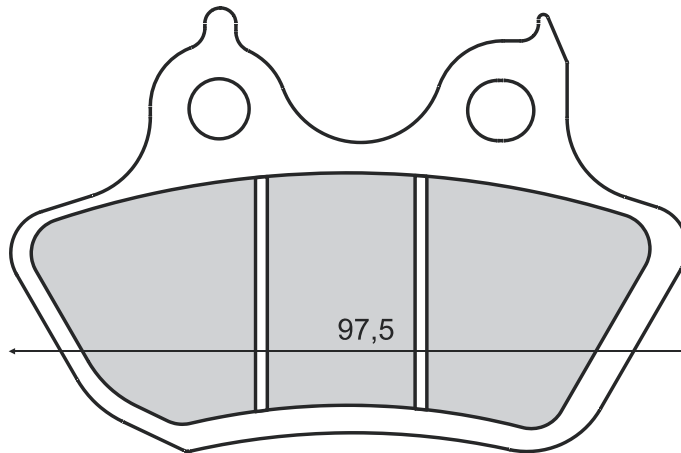

I codici con il numero 0 finale: **MESCOLA ORGANICA**
I codici con il numero 3 finale: **MESCOLA SINTERIZZATA**
Non omologata

PASTIGLIE FRENO IN ORDINE DI CODICE
BRAKE PADS SEARCH BY CODE NUMBER



22 510 3373

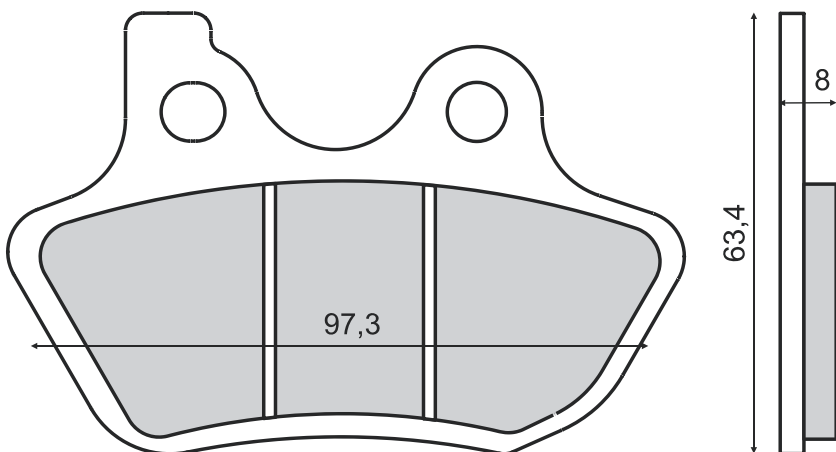
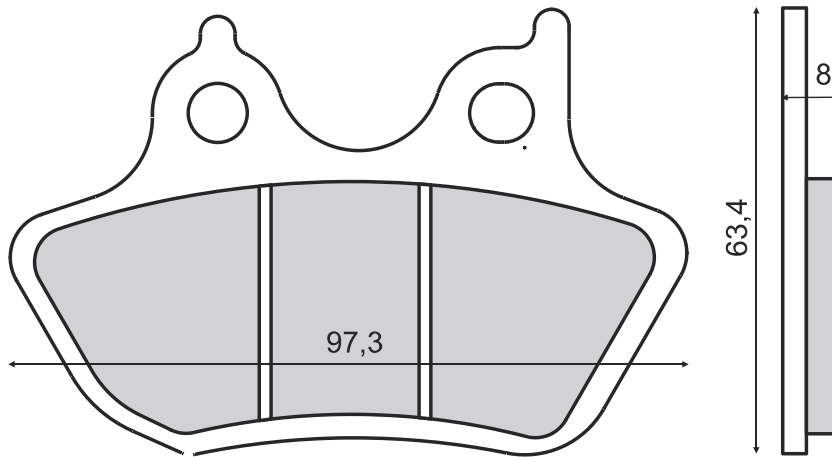

22 510 3383

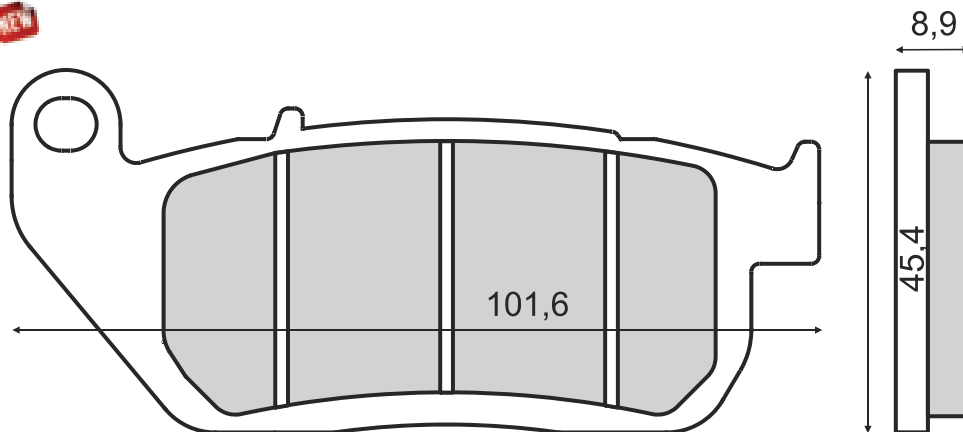

22 510 3393

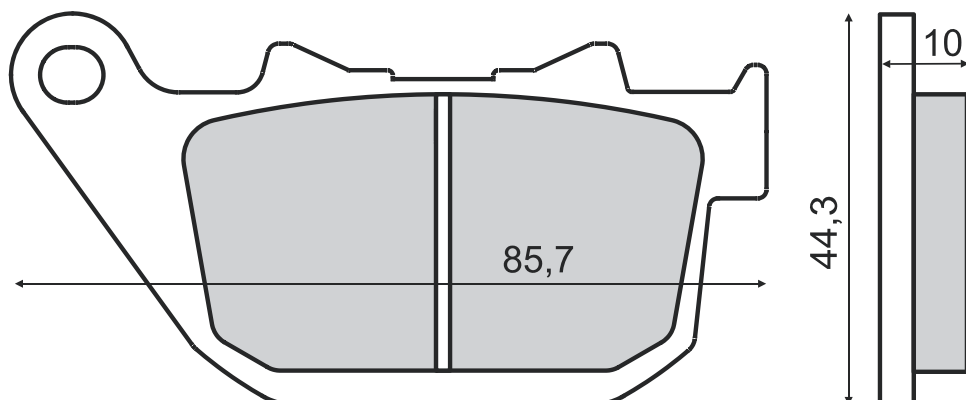



PASTIGLIE FRENO IN ORDINE DI CODICE
BRAKE PADS SEARCH BY CODE NUMBER

22 510 3403

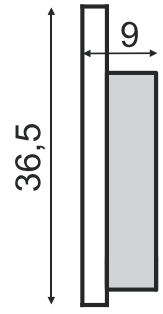
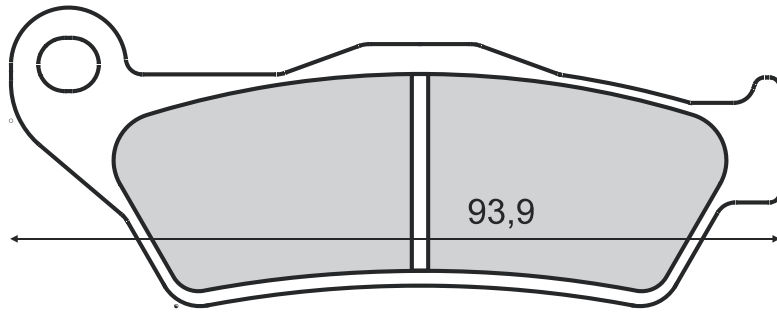

22 510 3413

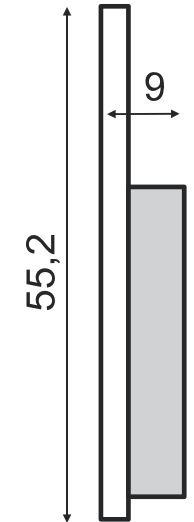
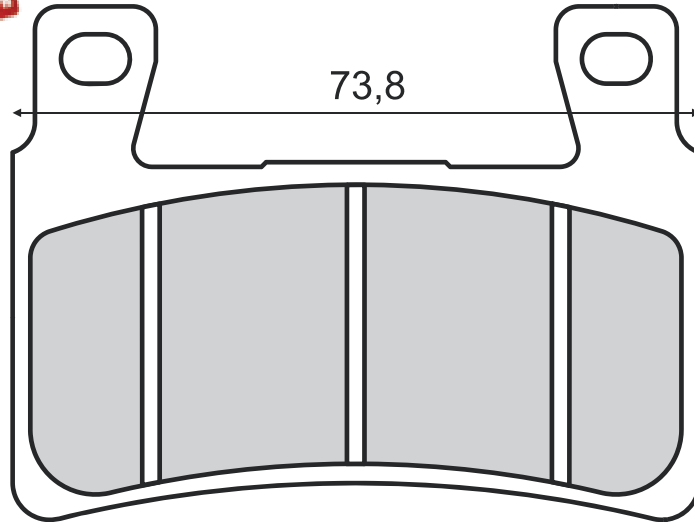

22 510 3423

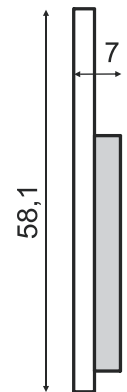
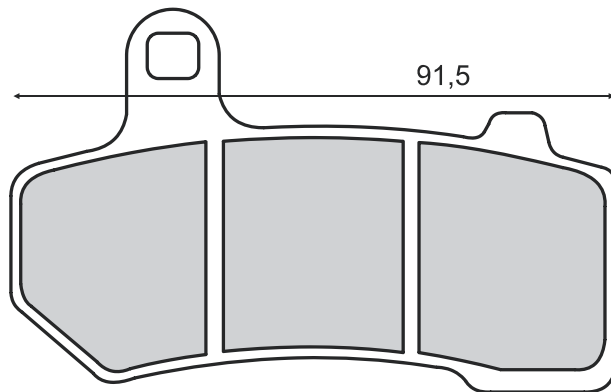

22 510 3433

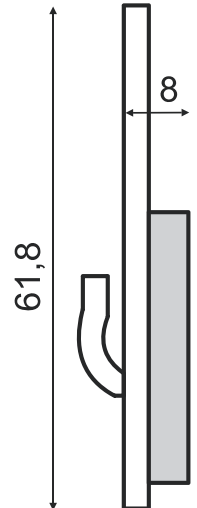
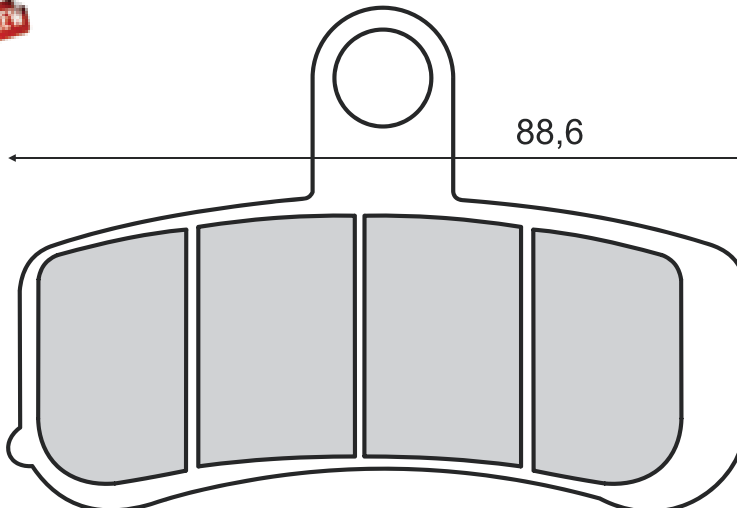



22 512 0050 

22 512 0051 

MBK • YAMAHA

Anteriore - *Front* • Posteriore - *Rear*



22 512 0060 

22 512 0061 

**ADLY • CPI • FANTIC • ITALJET • LEM
 • KEE • KOTIR • MAICO • MALAGUTI •
 MBK • SULA • YAMAHA • WAY**

Anteriore - *Front* • Posteriore - *Rear*



22 512 0070 

HONDA • KYMCO

Anteriore - *Front* • Posteriore - *Rear*



22 512 0080 

CPI • HONDA

Anteriore - *Front* • Posteriore - *Rear*



22 512 0090 

22 512 0091 

**APRILIA • ATALA • BENELLI • BETA
 • BS • DAELIM • VILLA • CAGIVA •
 KYMCO • HONDA • MALAGUTI • PEU-
 GEOT • SYM • YAMAHA**

Anteriore - *Front* • Posteriore - *Rear*



22 512 0130 

**APRILIA • ATALA • CAGIVA • DERBI
 ITALJET • SUZUKI**

Anteriore - *Front*

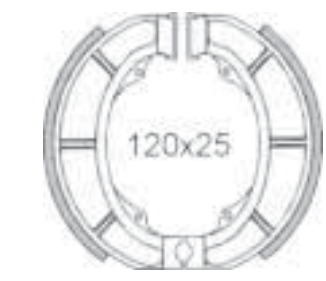

22 512 0160 

22 512 0161 

PIAGGIO: Vespa Px • Pe • Vnx • VLx • Vsx
 • Vnx2 • VLx2 • Vsx2
 (R.O. 414450)

Anteriore - *Front* • Posteriore - *Rear*



22 512 0170 

22 512 0171 

PIAGGIO: Vespa 50
 (R.O. 266506)

Anteriore - *Front*



22 512 0180 

22 512 0181 

PIAGGIO: Vespa 50
 (R.O. 2100492)

Posteriore - *Rear*



22 512 0190 

22 512 0191 

**BENELLI • PIAGGIO • BETA • FANTIC
 • GARELLI • GILERA • MALAGUTI •
 MOTO GUZZI • RIZZATO • TOMOS**

Anteriore - *Front* • Posteriore - *Rear*



22 512 0200 

22 512 0201 

**APRILIA • BETA • FANTIC • GARELLI •
 GILERA • ITALJET • PIAGGIO • RIZZATO**

Posteriore - *Rear*



22 512 0220 

22 512 0221 

PIAGGIO: Ape
 (R.O. 154998)

Posteriore - *Rear*





GANASCE FRENO - FIGURATO IN ORDINE DI CODICE
BRAKE SHOES ILLUSTRATED SECTION - SEARCH BY CODE NUMBER

22 512 0230



GILERA • ITALJET

PIAGGIO Ciclomotori/Mopeds

(R.O. 4144974)

Posteriore - Rear



22 512 0251



PIAGGIO: Ape

Kit 3 Ganasce/Kit 3 pcs.

(R.O. 498401)

Anteriore - Front • Posteriore - Rear



22 512 0261



PIAGGIO: Ape

Kit 3 Ganasce/Kit 3 pcs.

(R.O. 4154991)

Posteriore - Rear



22 512 0300



22 512 0301



GILERA • PIAGGIO

(R.O. 2691825)

Posteriore/Rear



22 512 0340



PIAGGIO

(R.O. 4144974)

Anteriore - Front



22 512 0350



22 512 0351



APRILIA • DERBI • GILERA • ITALJET •

PIAGGIO

(R.O. 82907R)

Posteriore - Rear



22 512 0360



GILERA • PIAGGIO

(R.O. 2727115)

Posteriore - Rear



22 512 0400



HONDA • ITALJET • KYMCO • MALA-

GUTI • PEUGEOT • PIAGGIO

Posteriore - Rear



22 512 0410



HONDA

Posteriore - Rear



22 512 0420



22 512 0421



APRILIA • GILERA • DERBI • PIAGGIO

(R.O. 56294R)

Posteriore - Rear



22 512 0450



22 512 0451



APRILIA • KEEWAY • MBK • YAMAHA

Posteriore - Rear



22 512 0460



YAMAHA

Posteriore - Rear





22 512 0470 

22 512 0471 

HONDA
Posteriore - Rear



22 512 0480 

YAMAHA
Posteriore - Rear



22 512 0490 

22 512 0491 

PIAGGIO: Vespa 50
(R.O. 090582)
Posteriore - Rear



22 512 0500 

PIAGGIO: Cosa1-2 - 125-150-200
(R.O. 414437)
Posteriore - Rear



22 512 0520 

PIAGGIO: Vespa 150 Sprint Veloce •
Vespa 160 Gs • Vespa 180 Ss • Vespa
200 Rally
(R.O. 026832)
Anteriore - Front



22 512 0530 

22 512 0531 

PIAGGIO 125-150: Vespa Super
(R.O. 081229)
Posteriore - Rear



22 512 0540 

PIAGGIO 150: Vespa Super
(R.O. 110412)
Posteriore - Rear



22 512 0550 

22 512 0551 

PIAGGIO 125-150: Vespa 51-62
(R.O. 078170)
Posteriore - Rear



22 512 0560 

APRILIA • DERBI • MALAGUTI • PIAGGIO
(R.O. 56293R)
Posteriore - Rear



22 512 0570 

PIAGGIO: Vespa Px • Pe • Vnx • VLx • Vsx •
Vnx2 • VLx2 • Vsx2
(R.O. 414450)
Anteriore - Front • Posteriore - Rear



22 512 0601 

INNOCENTI: Lambretta LI 125-150-175 •
Lambretta TV II 175
Anteriore - Front • Posteriore - Rear



22 512 0611 















KYMC0: 50-125-150
(R.O. 4312AKUDU920 • 00158047)
MALAGUTI: Ciak 125-150
(R.O. 11954700)
Posteriore - Rear





PASTIGLIE FRENO RMS - SINTER (RICERCA PER MARCA)











RMS - SINTER BRAKE PADS (SEARCH BY BRAND)

CC	MODELLO MODEL	ANNO YEAR								
			 ANTERIORE - FRONT		 POSTERIORE - REAR		 ANTERIORE FRONT	 POSTERIORE REAR		
			PASTIGLIA ORGANICA - ORGANIC				PASTIGLIA SINTERIZZATA SINTERED			
			 OMOLOGATA HOMOLOGATED	 NON OMOLOGATA NOT HOMOLOGATED	 GANASCE BRAKE SHOES	 OMOLOGATA HOMOLOGATED	 NON OMOLOGATA NOT HOMOLOGATED	 GANASCE BRAKE SHOES		
			22 510	22 512	22 510	22512	22 510	22 510		
ACCOSSATO										
50	50 Enduro Codice	89>			0070					
50	Ce 50	87>	0010		0070		0013			
80	Ce 80	87>	0010		0010		0013			
80	Kr 80	87>	0010		0070		0013			
ADLY										
25	Silver Fox 25	00>05	0180				0061			
50	Cat 50	01>	0180							
50	Cosy 50	01>	0180							
50	Fox 50	00>	0180				0061			
50	Fox Plus 50	01>	0180							
50	Jet 50	96>	0180				0061			
50	Panther 50	01>	2800							
50	Pista - Twin Light 50	96>	0180				0061			
50	Rt 50 Road Tracer	02>	0180							
50	Silver Fox 50	00>05	0180				0061			
50	Silver Fox 50	06>	2800				0061			
50	Super Sonic 50	00>	2800							
50	Super Sonic 50	06>	2800		2800					
50	Thunderbike 50	97>	2800							
70	Fox Plus 70	01>	0180							
70	Pista - Twin Light 70	96>	0180							
80	Cosy 80	01>	0180							
90	Rt 90 Road Tracer	02>	0180							
100	Cat 100	01>	0180							
100	Jet 100	96>	0180				0061			
100	Panther 100	01>	2800							
100	Rs 100 Super Sonic	01>	2800							
100	Rt 100 Road Tracer	02>	0180							
100	Silver Fox 100	00>05	0180							
100	Silver Fox 100	06>	2800				0061			
100	Thunderbike 100	01>	2800		2800					
125	Cat 125	01>	0180							
125	Super Sonic 125	01>	2800							
125	Thunderbike 125	01>	2800		2800					
ADLY ATV										
150	Atv 150	05>	0040		0040					
150	Interceptor 150	05>	0040		0040					

PASTIGLIE FRENO RMS - SINTER (RICERCA PER MARCA)

RMS - SINTER BRAKE PADS (SEARCH BY BRAND)

















CC	MODELLO MODEL	ANNO YEAR	RMS YOUR BEST PARTNER				SINTER	
			 ANTERIORE - FRONT		 POSTERIORE - REAR		 ANTERIORE FRONT	 POSTERIORE REAR
			PASTIGLIA ORGANICA - ORGANIC				PASTIGLIA SINTERIZZATA SINTERED	
								
			OMOLOGATA HOMOLOGATED	NON OMOLOGATA NOT HOMOLOGATED	GANASCE BRAKE SHOES	OMOLOGATA HOMOLOGATED	NON OMOLOGATA NOT HOMOLOGATED	GANASCE BRAKE SHOES
22 510		22 512	22 510		22512	22 510	22 510	
300	Atv 300	05>	0040	0040				
300	Cross X Over 300 - Cross X Road 300	07>	3070			3073		
300	Sport 300	07>	3070			3073		
320	S 320	07>	3070			3073		
320	U 320	07>	3070			3073		
AEON								
50	Aero 50	06>	0040					
50	Regal 50	06>	0040					
50	Torch 50	06>	0040					
90	Regal 90	06>	0040					
100	Pulsar 100	06>	0040					
100	Revo 2 100	04>		0040				
110	Aero 110	06>	0040					
110	Pulsar 110	06>	0040					
125	Overland 125	02>		1070			1073	
125	Pulsar 125	06>	0040					
150	Pulsar 150	06>	0040					
180	Overland 180	02>		1070			1073	
180	Roadster 180	02>		1070			1073	
AJP								
125	Pr3 125 Enduro	08>	0360			0363		
125	Pr3 125 Supermotard	08>	0360			0363		
125	Pr4 125 Enduro	04>07	0740					
125	Pr4 125 Supermotard	04>07	0740					
200	Mx 200	09>	0360			0363		
200	Pr3 200 Enduro	08>	0360			0363		
200	Pr3 200 Supermotard	08>	0360			0363		
200	Pr4 200 Enduro	04>07	0740					
200	Pr4 200 Supermotard	04>07	0740					
250	Pr5 250 Enduro	09>	0920	2630		0923	2633	
250	Pr5 250 Supermotard	09>	0920	2630		0923	2633	
ALFER								
80	Mc 80	88>	0010	0080		0013	0083	
80	Mc 80 Cross	89>	0010	0010		0013	0013	
125	Mc 125	87>	0010	0010		0013	0013	
125	Mc 125	88>	0530	0010		0533	0013	
125	Vre 125 4 Stroke	00>	0430	1330			1333	
250	Ar 250	92>		1200				



PASTIGLIE FRENO RMS - SINTER (RICERCA PER MARCA)

RMS - SINTER BRAKE PADS (SEARCH BY BRAND)

CC	MODELLO MODEL	ANNO YEAR								
			 ANTERIORE - FRONT		 POSTERIORE - REAR		 ANTERIORE FRONT	 POSTERIORE REAR		
			PASTIGLIA ORGANICA - ORGANIC				PASTIGLIA SINTERIZZATA SINTERED			
			 OMOLOGATA HOMOLOGATED	 NON OMOLOGATA NOT HOMOLOGATED	 GANASCE BRAKE SHOES	 OMOLOGATA HOMOLOGATED	 NON OMOLOGATA NOT HOMOLOGATED	 GANASCE BRAKE SHOES		
			22 510	22 512	22 510	22512	22 510	22 510		
250	Ar 250	93>	0430		1200					
250	Gr 250 Enduro	85>87	0010		0010		0013	0013		
250	Gr 250 Enduro	88>	0530		0010		0533	0013		
250	Mc 250	85>86	0010				0013			
250	Mc 250	87>	0010		0010		0013	0013		
250	Mc 250	88>	0530		0010		0533	0013		
250	Vr 250	94>	0430		1200					
250	Vr 250 Enduro	95>	0430		1330			1333		
250	Vr 250 Motocross	95>	0430		1330			1333		
250	Vr 250 No Limits	95>	0430		1330			1333		
250	Vr 250 Supermotard	99>	0430		1330			1333		
300	Gr 300 Enduro	85>87	0010		0010		0013			
300	Gr 300 Enduro	89>			0530			0533		
300	Tx 300	90>	0080		0010		0083	0013		
ALP										
125	Pr3 125 Enduro	08>			0640					
125	Pr3 125 Supermotard	08>			0640					
125	Pr4 125 Enduro	04>07			0640					
125	Pr4 125 Supermotard	04>07			0640					
200	Mx 200	09>			0080			0083		
200	Pr3 200 Enduro	08>			0640					
200	Pr3 200 Supermotard	08>			0640					
200	Pr4 200 Enduro	04>07			0640					
200	Pr4 200 Supermotard	04>07			0640					
APRILIA										
50	Af1 50 Ae All Models	87>	0070							
50	Af1 50 Europa	91>	0070							
50	Af1 50 Futura	90>	0070			0020				
50	Amico 50	90>91		0091			0091			
50	Amico 50 All Models	92>	0190				0091	0193		
50	Area 51 50	98>	0190		0190		0193	0193		
50	Classic 50	92>	0360				0363			
50	Et 50 Ae	87>	0070							
50	Etx 50	86>	0070			0020				
50	Gulliver 50	95>	0190				0091	0193		
50	Habana 50 All Models	98>	0190					0193		
50	Mojto 50	03>05	0190					0193		
50	Mojto Custom	99>03	0010			0130	0013			

PASTIGLIE FRENO RMS - SINTER (RICERCA PER MARCA)

RMS - SINTER BRAKE PADS (SEARCH BY BRAND)















CC	MODELLO MODEL	ANNO YEAR	RMS YOUR BEST PARTNER				SINTER	
			ANTERIORE - FRONT		POSTERIORE - REAR		ANTERIORE FRONT	POSTERIORE REAR
			PASTIGLIA ORGANICA - ORGANIC				PASTIGLIA SINTERIZZATA SINTERED	
			OMOLOGATA HOMOLOGATED	NON OMOLOGATA NOT HOMOLOGATED	GANASCE BRAKE SHOES	OMOLOGATA HOMOLOGATED	NON OMOLOGATA NOT HOMOLOGATED	GANASCE BRAKE SHOES
22 510		22 512	22 510		22512	22 510	22 510	
50	Mojto Retro	99>03	0010		0130		0013	
50	Mx 50	00>	0360				0363	
50	Pegaso	92>94			0020			
50	Rally 50	95>	0190		0091		0193	
50	Rally 50 Liquid Cooled	96>	0190		0190		0193	0193
50	Red Rose 50	88>91	0070					
50	Red Rose 50	92>	0070					
50	Rs 50	06>	0490		0080		0493	0083
50	Rs 50	93>95	0010		0010		0013	
50	Rs 50	96>99	0010		0020		0013	
50	Rs 50 Replica	00>02	0360		0080		0363	0083
50	Rs 50 Replica	03>05	0360				0363	
50	Rs4 50 (4T)	11>12	3160				3163	
50	Rx 50	08>	0740		0080			0083
50	Rx 50	90>91	0070		0020			
50	Rx 50	92>95	0360		0120		0363	
50	Rx 50	96>98	0010		0120		0013	
50	Rx 50 Racing	04>07	0360				0363	
50	Scarabeo 50	94>95			0091			
50	Scarabeo 50	96>	0190		0091		0193	
50	Scarabeo 50 All Models	98>05	0190		0190		0193	0193
50	Scarabeo 50 Ditech	01>04	0190		0310		0193	0313
50	Sonic 50 Gp	97>	0190		0091		0193	
50	Sonic 50 Spice	97>	0190		0091		0193	
50	Sport City 50 One 2T	08>10	2620		0351		2623	
50	Sport City 50 One 4T	08>10	2620		0351		2623	
50	Sr 50 2000	00>	0190		0310		0193	0313
50	Sr 50 All Models	93>96	3210		0091			
50	Sr 50 ie Ditech	02>	0190		0310		0193	0313
50	Sr 50 R Factory (Pinza Grimeca)	04>05	0010		0310		0013	0313
50	Sr 50 Stealth - Racing	97>	0190		0190		0193	0193
50	Sr 50 Www - Netscaper	97>	0190		0190		0193	0193
50	Sr H2o Ditech e Carburatore	00>04	0010		0130		0013	
50	Tuareg 50	86>	0070					
50	Tuareg 50	87>	0070		0120			
50	Tuareg 50 Hpc System	87>	0060		0010		0063	0013
50	Tuareg 50 Rally	90>	0070		0020			
70	Scarabeo 70	94>	0190		0091		0193	



PASTIGLIE FRENO RMS - SINTER (RICERCA PER MARCA)

RMS - SINTER BRAKE PADS (SEARCH BY BRAND)

CC	MODELLO MODEL	ANNO YEAR						
			 ANTERIORE - FRONT		 POSTERIORE - REAR		 ANTERIORE FRONT	 POSTERIORE REAR
			PASTIGLIA ORGANICA - ORGANIC				PASTIGLIA SINTERIZZATA SINTERED	
			 OMOLOGATA HOMOLOGATED	 NON OMOLOGATA NOT HOMOLOGATED	 OMOLOGATA HOMOLOGATED	 NON OMOLOGATA NOT HOMOLOGATED	 GANASCE BRAKE SHOES	 GANASCE BRAKE SHOES
			22 510	22 512	22 510	22512	22 510	22 510
80	Classic 80	93>	0070					
100	Scarabeo 100 (Motore Minarelli)	00>	0460		0451			
100	Scarabeo 100 (Motore Yamaha)	00>	0460					
100	Scarabeo 100 4T	01>04	0460		0310		0313	
125	Af1 125	87>			0010		0013	
125	Af1 125 Europa	90>91	0530		0010		0533 0013	
125	Af1 125 Futura	90>91	0530		0010		0533 0013	
125	Af1 125 Replica	89>91	0530		0010		0533 0013	
125	Af1 125 Sintesi	89>91	0530		0010		0533 0013	
125	Arecife 125 (Spagna)	03>	2670	0440	0310		2673 0313	
125	Asr 125	86>			0010		0013	
125	Atlantic 125 (Pinza Grimeca)	03>05	2670	0440	0310		2673 0313	
125	Classic 125	96>	0740		0010		0013	
125	Etx 125	85>86	0010					
125	Etx 125	86>97	0060		0063			
125	Etx 125	98>	0360		0363			
125	Habana 125 All Models	99>	0460		0421			
125	Leonardo 125	95>96	0010		0190		0013 0193	
125	Leonardo 125	97>98	2020		0190		0193	
125	Leonardo 125	99>	0460		0460			
125	Mojto 125 All Models	99>04	0460		0421			
125	Mx 125	04>	0430					
125	Mx 125 Supermoto	07>	0430					
125	Pegaso 125	89>	0740					
125	Pegaso 125 Kat	94>	0360		0363			
125	Red Rose 125	89>89	0060		0063			
125	Red Rose 125	90>	0740					
125	Rs 125	06>	2830		0310		2833 0313	
125	Rs 125 All Models	93>05	0530		0010		0533 0013	
125	Rs 125 Extrema/Replica	93>98	0530		0010		0533 0013	
125	Rs4 125 (4T)	11>12	3160		3163			
125	Rx 125	86>	0060				0063	
125	Rx 125	90>	0740					
125	Rx 125	91>	0740					
125	Rx 125	92>94	0360		0363			
125	Rx 125	95>	0430					
125	Rx 125 Enduro	08>	0430					
125	Rx 125 Supermotard	08>	0430					

PASTIGLIE FRENO RMS - SINTER (RICERCA PER MARCA)

RMS - SINTER BRAKE PADS (SEARCH BY BRAND)

















CC	MODELLO MODEL	ANNO YEAR	RMS YOUR BEST PARTNER				SINTER			
			ANTERIORE - FRONT		POSTERIORE - REAR		ANTERIORE FRONT	POSTERIORE REAR		
			PASTIGLIA ORGANICA - ORGANIC				PASTIGLIA SINTERIZZATA SINTERED			
			OMOLOGATA HOMOLOGATED	NON OMOLOGATA NOT HOMOLOGATED	GANASCE BRAKE SHOES	OMOLOGATA HOMOLOGATED	NON OMOLOGATA NOT HOMOLOGATED	GANASCE BRAKE SHOES		
			22 510	22 512	22 510	22512	22 510	22 510	22 510	22 510
125	Scarabeo 125	04>06	2670	0440	0310			2673	0313	
125	Scarabeo 125	98>	0060		0310			0063	0313	
125	Scarabeo 125 (Motore Piaggio)	03>	0060		0310			0063	0313	
125	Sport City 125 (Pinza Grimeca)	04>05	0060		0310			0063	0313	
125	Sport City 125 (Pinza Heng Tong)	04>06		0760	0010				0013	
125	Sport City 125 Eu3 (Pinza Grimeca)	06>	0060		0310			0063	0313	
125	Sport City 125 Eu3 (Pinza Heng Tong)	06>08		0760						
125	Sport City 125 One 4T Eu3	08>10	2620			0421		2623		
125	Sport City Street	12>08		0760						
125	Sport Pro 125	93>	0530		0010			0533	0013	
125	Sr 125	99>	0460			0421				
125	Sr 125 Replica	00>	0460							
125	Trend Go West 125	87>	0060					0063		
125	Tuareg 125	86>	0060		0010			0063	0013	
125	Tuareg 125	87>	0060		0010			0063	0013	
125	Tuareg 125 Rally	86>	0060					0063		
125	Tuareg 125 Rally	89>90	0740							
125	Tuareg 125 Rally (Mozzi Rimoldi)	86>	0060					0063		
125	Tuareg 125 Wind	90>			0010				0013	
125	Tx 125 M	86>	0080					0083		
150	Leonardo 150	97>98	2020		0190				0193	
150	Leonardo 150	99>	0460		0460					
150	Mojto 150 All Models	03>04	0460							
150	Scarabeo 150	98>	0060		0310			0063	0313	
150	Sr 150	99>	0460			0421				
200	Arecife 200 (Spagna)	03>	2670	0440	0310			2673	0313	
200	Atlantic 200 (Pinza Grimeca)	03>05	2670	0440	0310			2673	0313	
200	Climber 200	89>90			0020					
200	Climber 200	93>	0010		0010			0013		
200	Scarabeo 200	01>03	0060		0310			0063	0313	
200	Scarabeo 200 (Motore Piaggio)	03>	0060		0310			0063	0313	
200	Sport City 200 Eu3 (Pinza Heng Tong)	06>08		0760						
200	Sport City 200 (Pinza Grimeca)	04>05	0060		0310			0063	0313	
200	Sport City 200 (Pinza Heng Tong)	04>05		0760	0010				0013	
200	Sport City 200 Eu3 (Pinza Grimeca)	06>	0060		0310			0063	0313	
240	Climber 240	89>90	0070							
240	Trx 240 M	89>	0070		0070					
250	Af1 250 Replica	90>			3150				3153	



PASTIGLIE FRENO RMS - SINTER (RICERCA PER MARCA)

RMS - SINTER BRAKE PADS (SEARCH BY BRAND)

CC	MODELLO MODEL	ANNO YEAR								
			 ANTERIORE - FRONT		 POSTERIORE - REAR		 ANTERIORE FRONT	 POSTERIORE REAR		
			PASTIGLIA ORGANICA - ORGANIC				PASTIGLIA SINTERIZZATA SINTERED			
			 OMOLOGATA HOMOLOGATED	 NON OMOLOGATA NOT HOMOLOGATED	 GANASCE BRAKE SHOES	 OMOLOGATA HOMOLOGATED	 NON OMOLOGATA NOT HOMOLOGATED	 GANASCE BRAKE SHOES		
			22 510		22 512	22 510		22512	22 510	22 510
250	Af1 250 Replica	90>	0530				0533			
250	Atlantic 250 (Pinza Grimeca)	03>05	2670	0440	0310		2673	0313		
250	Atlantic 250 (Pinza Heng Tong)	03>05	2670	0440	0010			0013		
250	Atlantic 250 ie	07>	2670	0440	0310		2673	0313		
250	Leonardo 250	99>	0060		0310		0063	0313		
250	Mx 250	83>	0010				0013			
250	Rs 250	95>96	0520		0010		0523	0013		
250	Rs 250	97>	0520		0190		0523	0193		
250	Rs 250	98>	1100		0190		1103	0193		
250	Rs 250 Pista	04>	1100		0190		1103	0193		
250	Rx 250	83>	0010				0013			
250	Rx 250	86>	0010				0013			
250	Scarabeo 250	04>06	2670	0440	0310		2673	0313		
250	Sport City 250 Cube	08>10	0060		0310		0063	0313		
250	Sport City 250 Eu3 (Pinza Grimeca)	06>	0060		0310		0063	0313		
250	Tuareg 250 Rally	86>	0060				0063			
250	Tuareg 250 Rally (Mozzi Rimoldi)	86>	0060				0063			
275	Climber 275	89>92	0070		0020					
280	Climber 280	93>	0080		0080		0083	0083		
300	Leonardo 300	02>	0060		0310		0063	0313		
300	Scarabeo 300 Special	09>	2670	0440	0310		2673	0313		
300	Tx 300	86>	0080				0083			
300	Tx 300 M	86>	0080				0083			
311	Tx 311 M	87>	0080				0083			
312	Tx 312 M	88>	0080		0080		0083	0083		
312	Txr 312 M	88>	0080		0080		0083	0083		
350	Etx 350	86>	0060		0010		0063	0013		
350	Etx 350 Ae	87>	0060		0010		0063	0013		
350	Tuareg 350	87>	0060		0010		0063	0013		
350	Tuareg 350 Wind	87>88	0060		0010		0063	0013		
350	Tuareg 350 Wind	89>					1200			
350	Tuareg 350 Wind	90>					1200			
400	Scarabeo 400 ie	07>	0060		0310		0063	0313		
400	Scarabeo 400 Light	06>08	0060		0490		0063	0493		
450	Mxv 450 4.5	09>	0920		0660		0923	0663		
450	Rxv 450 4.5	06>	0920		1450		0923	1453		
450	Sxv 450	05>					1450			
450	Sxv Replica 450 Van De Bosch	05>					1450			

PASTIGLIE FRENO RMS - SINTER (RICERCA PER MARCA)

RMS - SINTER BRAKE PADS (SEARCH BY BRAND)

















CC	MODELLO MODEL	ANNO YEAR	RMS YOUR BEST PARTNER				SINTER	
			ANTERIORE - FRONT		POSTERIORE - REAR		ANTERIORE FRONT	POSTERIORE REAR
			PASTIGLIA ORGANICA - ORGANIC				PASTIGLIA SINTERIZZATA SINTERED	
			OMOLOGATA HOMOLOGATED	NON OMOLOGATA NOT HOMOLOGATED	GANASCE BRAKE SHOES	OMOLOGATA HOMOLOGATED	NON OMOLOGATA NOT HOMOLOGATED	GANASCE BRAKE SHOES
22 510		22 512	22 510		22512	22 510	22 510	
500	Arecife 500 (Pinza Dx) (Spagna)	02>04	0680		0310			
500	Arecife 500 (Pinza Sx) (Spagna)	02>04	0060		0310		0063	0313
500	Atlantic 500 (Pinza Dx)	02>04	0680		0310			
500	Atlantic 500 (Pinza Sx)	02>04	0060		0310		0063	0313
500	Atlantic 500 Sprint	05>	2670	0440	0310		2673	0313
500	Scarabeo 500	02>06	0060		0310		0063	0313
500	Scarabeo 500 Class	10>	0060		0310		0063	0313
500	Scarabeo 500 ie	07>	0060		0310		0063	0313
500	Scarabeo 500 Light	06>08	0060		0310		0063	0313
550	Sxv 550	06>			1450			1453
550	Sxv Replica 550 Van De Bosch	05>			1450			1453
600	Etx 600	86>	0060		0010		0063	0013
600	Pegaso 600	90>	1010				1013	
600	Tuareg 600 Wind	89>	1200		1200			
650	Moto' 650 6.5	95>96	1010				1013	
650	Moto' 650 6.5	97>	1010				1013	
650	Pegaso 650	96>	0430					
650	Pegaso 650	97>	1010				1013	
650	Pegaso 650 Factory	07>			1330			1333
650	Pegaso 650 ie	01>	1010		1330		1013	1333
650	Pegaso 650 Strada	05>	1100		1330		1103	1333
650	Pegaso 650 Tuscany Tibet Raid	04>	1010		1330		1013	1333
650	Starck 650	96>	1010				1013	
750	Sl 750 Shiver	07>	2830		1330		2833	1333
750	Sl 750 Shiver Gt	09>	2830		1330		2833	1333
750	Smv 750 Dorsoduro	08>	1100		1330		1103	1333
750	Smv 750 Dorsoduro	09>	2830		1330		2833	1333
850	Na 850 Mana	07>	2830		1330		2833	1333
850	Na 850 Mana	08>	2830		0060		2833	0063
850	Na 850 Mana Gt	09>	2830		0060		2833	0063
1000	1000 Blue Marlin	02>	1100		0490		1103	0493
1000	Etv 1000 Caponord	01>	1010		0490		1013	0493
1000	Etv 1000 Caponord Rally Raid	04>	1010		0490		1013	0493
1000	Rst 1000 Futura	01>	1100		0430		1103	
1000	Rsv 1000 Factory	04>	2860		0490		2863	0493
1000	Rsv 1000 Mille	97>01	1100		0490		1103	0493
1000	Rsv 1000 Mille Nera	04>	2860		0490		2863	0493
1000	Rsv 1000 Mille R	98>00	1100		0490		1103	0493



PASTIGLIE FRENO RMS - SINTER (RICERCA PER MARCA)

RMS - SINTER BRAKE PADS (SEARCH BY BRAND)

CC	MODELLO MODEL	ANNO YEAR								
			 ANTERIORE - FRONT		 POSTERIORE - REAR		 ANTERIORE FRONT	 POSTERIORE REAR		
			PASTIGLIA ORGANICA - ORGANIC				PASTIGLIA SINTERIZZATA SINTERED			
			 OMOLOGATA HOMOLOGATED	 NON OMOLOGATA NOT HOMOLOGATED	 GANASCE BRAKE SHOES	 OMOLOGATA HOMOLOGATED	 NON OMOLOGATA NOT HOMOLOGATED	 GANASCE BRAKE SHOES		
			22 510	22 512	22 510	22512	22 510	22 510		
1000	Rsv 1000 Mille R	02>05	2860		0490		2863	0493		
1000	Rsv 1000 SI - R Falco	00>	1100		0490		1103	0493		
1000	Rsv 1000 Sp	00>	1100		0490		1103	0493		
1000	Rsv 1000 Tuono	02>	1100		0490		1103	0493		
1000	Rsv 1000 Tuono Figther	03>05	1100		0490		1103	0493		
1000	Rsv 1000 Tuono R	02>	1100		0490		1103	0493		
1000	Rsv 1000 Tuono R	03>	2860		0490		2863	0493		
1000	Rsv 1000 Tuono R Factory	06>	2860		0490		2863	0493		
1000	Rsv 1000 Tuono V4r	11>	1100		0490		1103	0493		
1000	Rsv4 1000	09>			0490		2923	0493		
1000	Rsv4-R 1000	10>			0490		2923	0493		
1200	Caponord 1200	13>					3193			
1200	Dorsoduro 1200	11>	1100		1330		1103	1333		
ARTIC CAT ATV										
400	Dvx 400	04>	1440							
ATALA										
50	Byte 50	96>	0190				0193			
50	Carosello 50	97>	0190			0091	0193			
50	Hacker 50	96>	0190				0193			
50	Hacker 50	>95	0190				0193			
50	Scheggia 50	98>	0190			0130	0193			
125	Hacker 125	98>	0190				0193			
ATK										
560	Atk 560	87>88			0080			0083		
560	Atk 560	89>91			0070					
604	Atk 604 Quadracer	90>			0070					
ATK (USA)										
250	Atk 250 Cc/Mx	91>92	0530		0010		0533	0013		
350	Atk 350 Es/Cc/Mx/Std	91>92	0530		0010		0533	0013		
350	Atk 350 Gs	93>	0010		0010			0013		
406	Atk 406 Cc/Mx	91>92	0530		0010		0533	0013		
560	Atk 560	84>85	0010				0013			
560	Atk 560	86>	0010				0013			
560	Atk 560	87>88	0010				0013			
560	Atk 560	89>91	0530				0533			
604	Atk 604	91>	0530				0533			
604	Atk 604 Es/Cc/Mx/Std	91>92	0530		0010		0533	0013		
604	Atk 604 Quadracer	90>	0530				0533			

PASTIGLIE FRENO RMS - SINTER (RICERCA PER MARCA)

RMS - SINTER BRAKE PADS (SEARCH BY BRAND)

















CC	MODELLO MODEL	ANNO YEAR	RMS YOUR BEST PARTNER				SINTER	
			ANTERIORE - FRONT		POSTERIORE - REAR		ANTERIORE FRONT	POSTERIORE REAR
			PASTIGLIA ORGANICA - ORGANIC				PASTIGLIA SINTERIZZATA SINTERED	
			OMOLOGATA HOMOLOGATED	NON OMOLOGATA NOT HOMOLOGATED	GANASCE BRAKE SHOES	OMOLOGATA HOMOLOGATED	NON OMOLOGATA NOT HOMOLOGATED	GANASCE BRAKE SHOES
22 510		22 512	22 510		22512	22 510	22 510	
640	Atk 640	93>	0010		0010		0013	0013
BENELLI								
50	491 50 Gt	97>	0190			0091	0193	
50	491 50 Sport - Racing	97>	0190		0300		0193	0303
50	Bobo 50	78>		0191		0191		
50	Chrono 50	92>93	0070					
50	Chrono 50	94>	0190				0193	
50	Devil 50	92>	0530		0030		0533	
50	Export 3 V 50	79>		0191		0191		
50	G 2 50	79>		0191		0191		
50	K2 50 All Models	98>	0190		0190		0193	0193
50	Master 4 50	95>	0030					
50	Motorella 50	79>		0191		0191		
50	Naked 50	98>	0190				0193	
50	Pepe 50	99>04	0190			0091	0193	
50	Spring 50	92>	0530		0030		0533	
80	Devil 80	95>	0530		0030		0533	
100	100 Naked	02>	0190				0193	
100	K2 100 Biposto	99>	0190				0193	
100	Lx 100 Pepe	02>	0190				0193	
125	125 2 C	76>78	0010				0013	
125	125 2T - 2 Cse	76>78	0010				0013	
125	125 Jarno	89>	0530				0533	
125	666 125	98>			0190			0193
125	Adiva 125	00>02	0190		0450		0193	0453
125	Caffenero 125 (Pinza Dx)	08>	1420		1420		1423	
125	Caffenero 125 (Pinza Sx)	08>	1070		1420		1073	1423
125	Macis 125	10>	1420		1420		1423	1423
125	Velvet 125	99>04	0190		0190		0193	0193
125	Velvet 125 Touring	02>03	0190		0190		0193	0193
150	Adiva 150	00>02	0190		0450		0193	0453
150	Macis 150	10>	1420		1420		1423	1423
150	Velvet 150	99>04	0190		0190		0193	0193
150	Velvet 150 Touring	02>03	0190		0190		0193	0193
250	250 4	76>	0010				0013	
250	250 C	76>78	0010				0013	
250	250 Ts	76>78	0010				0013	
250	Caffe' Nero 250 (Pinza Dx)	08>	0580		0190		0583	0193



PASTIGLIE FRENO RMS - SINTER (RICERCA PER MARCA)

RMS - SINTER BRAKE PADS (SEARCH BY BRAND)

CC	MODELLO MODEL	ANNO YEAR								
			 ANTERIORE - FRONT		 POSTERIORE - REAR		 ANTERIORE FRONT	 POSTERIORE REAR		
			PASTIGLIA ORGANICA - ORGANIC				PASTIGLIA SINTERIZZATA SINTERED			
			 OMOLOGATA HOMOLOGATED	 NON OMOLOGATA NOT HOMOLOGATED	 GANASCE BRAKE SHOES	 OMOLOGATA HOMOLOGATED	 NON OMOLOGATA NOT HOMOLOGATED	 GANASCE BRAKE SHOES		
			22 510		22 512	22 510		22512	22 510	22 510
250	Caffe' Nero 250 (Pinza Sx)	08>	0350		0190		0353	0193		
250	Velvet 250	99>	0360		0310		0363	0313		
250	Velvet 250 Touring	01>	0360		0310		0363	0313		
350	350	83>	0010		0010		0013			
350	350 Sport	78>			3150			3153		
350	350 Sport li	78>			3150			3153		
350	350 T	78>			3150			3153		
350	350 4 Cil.	78>	0010				0013			
350	350 Sport	78>	0010				0013			
350	350 Sport li	78>	0010				0013			
350	350 T	78>	0010				0013			
400	Velvet 400 Dusk	03>	0360				0363			
449	Bx 449 Cross	07>	0430		1330			1333		
449	Bx 449 Supermotard	08>	2860		1330		2863	1333		
500	500	78>	0010		3150		0013	3153		
500	500 Ls	78>			3150			3153		
500	500 Ls	78>	0010				0013			
500	500 Quattro	76>	0010				0013			
505	Bx 505 Enduro	08>	0430		1330			1333		
650	650	82>	0010		3150		0013	3153		
650	650 Sport	78>			3150			3153		
650	650 T	78>			3150			3153		
650	650 Sport	78>	0010				0013			
650	650 T	78>	0010				0013			
666	666 125	98>	1100				1103			
750	Sei 750	76>	3150				3153			
756	Cue 756	07>09	2860		0490		2863	0493		
756	Cue 756	10>	1100		0490		1103	0493		
899	Tnt 899	07>	1100		0490		1103	0493		
899	Tnt 899 Century Racer	11>	2860		0490		2863	0493		
899	Trek 899	07>	1100		0490		1103	0493		
900	Sei 900	78>	3150				3153			
900	Tornado 3 900	00>02	1100		0010		1103	0013		
900	Tornado Tre 900	03>	2860		0490		2863	0493		
900	Tornado Tre 900 Rs	04>	2860		0490		2863	0493		
1100	Tnt 1100	04>	1100		0010		1103	0013		
1130	Tnt 1130	05>	1100		0490		1103	0493		
1130	Tnt 1130 Cafe Racer	05>	2860		0490		2863	0493		

PASTIGLIE FRENO RMS - SINTER (RICERCA PER MARCA)

RMS - SINTER BRAKE PADS (SEARCH BY BRAND)

















CC	MODELLO MODEL	ANNO YEAR	RMS YOUR BEST PARTNER				SINTER	
			ANTERIORE - FRONT		POSTERIORE - REAR		ANTERIORE FRONT	POSTERIORE REAR
			PASTIGLIA ORGANICA - ORGANIC				PASTIGLIA SINTERIZZATA SINTERED	
			OMOLOGATA HOMOLOGATED	NON OMOLOGATA NOT HOMOLOGATED	GANASCE BRAKE SHOES	OMOLOGATA HOMOLOGATED	NON OMOLOGATA NOT HOMOLOGATED	GANASCE BRAKE SHOES
22 510		22 512	22 510		22512	22 510	22 510	
1130	Tnt 1130 Century Racer	11>	2860		0490		2863	0493
1130	Tnt 1130 Officine	07>	2860		0490		2863	0493
1130	Tnt 1130 Sport	05>	2860		0490		2863	0493
1130	Tnt 1130 Titanium	05>	2860		0490		2863	0493
1130	Tnt 1130 Trek	06>	1100		0490		1103	0493
1130	Tnt 1130 Trek Amazonas	07>	1100		0490		1103	0493
1130	Tornado 3 1130	06>	2860		0490		2863	0493
BETA								
50	Alp 50	91>	0030		0070			
50	Andy 50 Ruote Lega	78>		0191		0191		
50	Andy 50 Ruote Raggi	78>		0191		0191		
50	Ark 50 All Models	96>	0190		0190		0193	0193
50	B12 50	73>		0191		0191		
50	Ch 50	96>	0190			0091	0193	
50	Chrono 50	92>94	0070			0091		
50	Chrono 50	94>	0070			0091		
50	Chrono 50 13	94>	0190			0091	0193	
50	Crono 50 502	97>	0190			0091	0193	
50	Eikon 50	99>03	0080		0080		0083	0083
50	Four Twin 50	88>	0030					
50	Kr 50	87>	0070					
50	Kr 50 Adventure	87>	0070		0120			
50	Mio 50	79>		0191		0191		
50	Mx 50 Enduro	92>	0080		0080		0083	0083
50	Pro Race 50	98>	0740					
50	Pro Race 50	04>	0650		0650			
50	Pulman 50	70>		0201		0201		
50	Quadra 50	95>96	0190			0091	0193	
50	Quadra 50	97>	0010			0091	0013	
50	Rr 50 Enduro	05>	0360		3020		0363	3023
50	Rr 50 Enduro Alu	04>	0360		0080		0363	0083
50	Rr 50 Pro Race	98>	0740		0080			0083
50	Rr 50 Supermotard	99>03	0740		0080			0083
50	Rr 50 Supermotard	04>07	0080		0080		0083	0083
50	Rr 50 Supermotard	08>	0360		3020		0363	3023
50	Rr 50 Supermotard Alu	04>	0360		3020		0363	3023
50	Supermotard 50	00>	0080		0080		0083	0083
50	Supertrial 50	92>	0080				0083	



PASTIGLIE FRENO RMS - SINTER (RICERCA PER MARCA)











RMS - SINTER BRAKE PADS (SEARCH BY BRAND)

CC	MODELLO MODEL	ANNO YEAR								
			 ANTERIORE - FRONT		 POSTERIORE - REAR		 ANTERIORE FRONT	 POSTERIORE REAR		
			PASTIGLIA ORGANICA - ORGANIC				PASTIGLIA SINTERIZZATA SINTERED			
			 OMOLOGATA HOMOLOGATED	 NON OMOLOGATA NOT HOMOLOGATED	 GANASCE BRAKE SHOES	 OMOLOGATA HOMOLOGATED	 NON OMOLOGATA NOT HOMOLOGATED	 GANASCE BRAKE SHOES		
			22 510		22 512	22 510		22512	22 510	22 510
50	Techno 50	96>	0080		0080		0083	0083		
50	Tempo 50	92>96	0080			0091	0083			
50	Tempo 50	97>98	0010			0091	0013			
50	Tempo 50	99>	0190			0091	0193			
50	Tempo 50 13	00>	0190			0091	0193			
50	Tempo 50 16	00>	0190			0091	0193			
50	Tr 50 (Spain)	89>	0080				0083			
80	Evo 80	09>	0640							
80	Evo 80 Junior	10>	0080		0080		0083	0083		
80	Rev 80	00>07	0080		0080		0083	0083		
80	Rev 80	08>	0640							
125	Alp 125	99>	0080		0080		0083	0083		
125	Alp 125 4T	99>05	0080		0080		0083	0083		
125	Alp 125 4T	06>08	0360		3020		0363	3023		
125	Eikon 125	99>	2020							
125	Eikon 125	99>03	0080		0080		0083	0083		
125	Eikon 125	99>			0310			0313		
125	Eikon 125	04>	0190		0310		0193	0313		
125	Evo 125 2T	09>	0640							
125	Jonathan 125	99>	0520		1330		0523	1333		
125	Kr 125	86>	0010				0013			
125	Kr 125 Afrika	87>	0010				0013			
125	Rev 3 125	00>05	0640		0640					
125	Rev 3 125	06>08	0640							
125	Rr 125 4T	05>06	0360		3020		0363	3023		
125	Rr 125 4T Re	08>	0360		3020		0363	3023		
125	Rr 125 Enduro 4T Eu3	08>	0360		3020		0363	3023		
125	Rr 125 Enduro Eu3	07>	0360		3020		0363	3023		
125	Rr 125 Motard 4T Eu3	08>	0360		3020		0363	3023		
125	Rr 125 Motard Eu3	07>	0360		3020		0363	3023		
125	Techno 125	98>	0080		0080		0083	0083		
125	Tr 32 125	86>	0030							
125	Tr 33 125	87>	0030							
125	Tr 34 125	88>	0030		0070					
125	Tr 35 125	90>	0080		0080		0083	0083		
125	Trial 125	97>	0080				0083			
125	Urban 125	08>	0360		3020		0363	3023		
150	Eikon 150	99>	2020		0310			0313		

PASTIGLIE FRENO RMS - SINTER (RICERCA PER MARCA)

RMS - SINTER BRAKE PADS (SEARCH BY BRAND)

















CC	MODELLO MODEL	ANNO YEAR	RMS YOUR BEST PARTNER				SINTER	
			 ANTERIORE - FRONT		 POSTERIORE - REAR		 ANTERIORE FRONT	 POSTERIORE REAR
			PASTIGLIA ORGANICA - ORGANIC				PASTIGLIA SINTERIZZATA SINTERED	
								
			OMOLOGATA HOMOLOGATED	NON OMOLOGATA NOT HOMOLOGATED	GANASCE BRAKE SHOES	OMOLOGATA HOMOLOGATED	NON OMOLOGATA NOT HOMOLOGATED	GANASCE BRAKE SHOES
22 510		22 512	22 510		22512	22 510	22 510	
150	Eikon 150	04>	0190		0310		0193	0313
200	Alp 200 4T	00>05	0080		0080		0083	0083
200	Alp 200 4T	06>08	0360		3020		0363	3023
200	Evo 200 2T	09>	0640					
200	Rev 3 200	00>05	0640		0640			
200	Rev 3 200	06>08	0640					
200	Urban 200	08>	0360		3020		0363	3023
240	Alp 240	91>95	0030					
240	Alp 240	96>	0080		0010		0083	0013
240	Supertrial 240	92>	0080				0083	
240	Tr 33 240	86>88	0030					
240	Tr 33 Trekking 240	88>	0030					
250	Alp 250	97>	0080		0080		0083	0083
250	Cr 250	83>	0010				0013	
250	Eikon 250	99>	0080		0080		0083	0083
250	Evo 250 2T	09>	0640					
250	Kr 250 Afrika	86>	0010				0013	
250	Kr 250 Rally	87>	0010				0013	
250	Rev 250 4T	07>08	0640					
250	Rev 3 250	00>04	0640		0640			
250	Rev 3 250	05>08	0640					
250	Rr 250 4T	05>	0920		1450		0923	1453
250	Techno 250	94>99	0080		0080		0083	0083
250	Tr 34 250	88>	0030		0070			
250	Tr 34 250 (Spain)	89>	0030		0030			
250	Tr 34 250 Professional	89>	0030		0070			
250	Tr 35 250	90>91	0080		0080		0083	0083
260	Alp 260	90>	0030					
260	Synt 260	92>	0080				0083	
260	Tr 34 260	87>88	0030		0070			
260	Tr 35 260	89>91	0030					
260	Zero 260 Gara - Techno - Synt	93>	0080				0083	
260	Zero 260 Synt	89>92	0080				0083	
270	Rev 3 270	00>04	0640		0640			
270	Rev 3 270	05>08	0640					
290	Evo 290 2T	09>	0640					
350	350 Jonathan	02>	0520		1330		0523	1333
350	Alp 350 4.0	03>	0360				0363	



PASTIGLIE FRENO RMS - SINTER (RICERCA PER MARCA)

RMS - SINTER BRAKE PADS (SEARCH BY BRAND)

CC	MODELLO MODEL	ANNO YEAR								
			 ANTERIORE - FRONT		 POSTERIORE - REAR		 ANTERIORE FRONT	 POSTERIORE REAR		
			PASTIGLIA ORGANICA - ORGANIC				PASTIGLIA SINTERIZZATA SINTERED			
			 OMOLOGATA HOMOLOGATED	 NON OMOLOGATA NOT HOMOLOGATED	 GANASCE BRAKE SHOES	 OMOLOGATA HOMOLOGATED	 NON OMOLOGATA NOT HOMOLOGATED	 GANASCE BRAKE SHOES		
			22 510		22 512	22 510		22512	22 510	22 510
350	Alp 350 4.0	04>08	0360		3020		0363	3023		
350	Euro 350	99>	0520		1330		0523	1333		
350	Motard 350 4.0	04>08			3020			3023		
400	Rr 400 4T	05>	0920		1450		0923	1453		
450	Rr 450 4T	05>	0920		1450		0923	1453		
500	Gs - Rv 500	84>	0010				0013			
525	Rr 525 4T	05>	0920		1450		0923	1453		
BIMOTA										
400	Yb 7 400	89>	0520		0010		0523	0013		
500	V Due 500	97>	0520		0010		0523	0013		
600	Bellaria 600 Sport	91>			3150			3153		
600	Bellaria 600 Sport	91>	0520				0523			
600	Yb 9 600 Sri	97>	0520		0010		0523	0013		
650	Supermono 650	97>	0520		0010		0523	0013		
750	Sb 7 750	96>	0520		0010		0523	0013		
750	Yb 4 750	89>	0520		0010		0523	0013		
851	Tesi 851 1D	91>			3150			3153		
851	Tesi 851 1D	91>	0520				0523			
900	Db 1 - 2 900	92>	0520		0010		0523	0013		
900	Db 4 900	99>	1100		0010		1103	0013		
900	Mantra 900	97>	0520		0010		0523	0013		
906	Tesi 906 1D	91>			3150			3153		
906	Tesi 906 1D	91>	0520				0523			
1000	Bb3	14					3333			
1000	1000 All Models ->1988	>88	3150		3150		3153	3153		
1000	Db 5 1000 Delirio	07>	2860		0490		2863	0493		
1000	Db 5 1000 Mille	05>	2860		0490		2863	0493		
1000	Db 5 1000 S	07>	2860		0490		2863	0493		
1000	Sb 3 1000	83>	3150		3150		3153	3153		
1000	Sb 8 1000 R	98>	1100		0010		1103	0013		
1000	Sb 8K 1000	06>	1100		0010		1103	0013		
1000	Sb 8K 1000 Santamonica	07>	2860		0010		2863	0013		
1000	Yb 10 1000 Biposto	92>	0520		0010		0523	0013		
1000	Yb 11 1000	97>	0520		0010		0523	0013		
1000	Yb 6 1000	89>	0520		0010		0523	0013		
1000	Yb 8 1000 E	90>	0520		0010		0523	0013		
1000	Yb 8 1000 E.i. Furano	90>	0520		0010		0523	0013		
1000	Yb 8 1000 Furano	92>	0520		0010		0523	0013		

PASTIGLIE FRENO RMS - SINTER (RICERCA PER MARCA)

RMS - SINTER BRAKE PADS (SEARCH BY BRAND)

















CC	MODELLO MODEL	ANNO YEAR	RMS YOUR BEST PARTNER				SINTER	
			ANTERIORE - FRONT		POSTERIORE - REAR		ANTERIORE FRONT	POSTERIORE REAR
			PASTIGLIA ORGANICA - ORGANIC				PASTIGLIA SINTERIZZATA SINTERED	
			OMOLOGATA HOMOLOGATED	NON OMOLOGATA NOT HOMOLOGATED	GANASCE BRAKE SHOES	OMOLOGATA HOMOLOGATED	NON OMOLOGATA NOT HOMOLOGATED	GANASCE BRAKE SHOES
22 510		22 512	22 510		22512	22 510	22 510	
1002	Yb 10 1002 Dieci	91>	0520				0523	
1002	Yb 10 Dieci 1002	91>			3150		3153	
1098	Db 7 1098	08>	2860		0490		2863	0493
1099	Db 7 1099	09>			0010		2923	0013
1099	Db7 (Pinze radiali - Rad.cal)	09					3333	
1100	Db 6R 1100 Delirio	08>	2860		0490		2863	0493
1100	Sb 6 1100	97>	0520		0010		0523	0013
1198	Db8 1198	10>			0490		2923	0493
1198	Db9 Brivido S	11>			0490		3043	0493
1198	Db9 Brivido Sc	11>			0490		3043	0493
1198	Db8 (Pinze radiali - Rad.cal)	10					3333	
1200	Db11 (Pinze radiali - Rad.cal)	13					3333	
BLATA								
125	Enduro 125	07>	3160		0080		3163	0083
125	Motard 125	07>	3160		0080		3163	0083
BMW								
125	C 1 125	99>	1010		1330		1013	1333
200	C 1 200	01>	1010		1330		1013	1333
450	G 450 Enduro	08>	0430		0750			0753
450	G 450 Smr	09>	2860		0750		2863	0753
450	R 45 450	81>	3150				3153	
650	F 650	94>00	1010		1330		1013	1333
650	F 650 Cs Scarver	02>06	1010		1330		1013	1333
650	F 650 Gs	08>	1010		1330		1013	1333
650	F 650 Gs Dakar / Rallye	01>07	1010		1330		1013	1333
650	F 650 St	94>00	1010		1330		1013	1333
650	G 650 Gs	09>	1010		1330		1013	1333
650	G 650 X Challenge	07>	1010		1330		1013	1333
650	G 650 X Country	07>	1010		1330		1013	1333
650	G 650 X Moto	07>	1100		1330		1103	1333
650	R 65 650	81>89	3150				3153	
650	R 65 650 Gs	87>	3150				3153	
650	R 65 650 Ls	>81	3150				3153	
750	K 75 750	90>			3150			3153
750	K 75 750	>88	3150				3153	
750	K 75 750 (Pinza Abs)	91>			3150			3153
750	K 75 750 Rt	91>93			3150			3153
750	K 75 750 S	88>93			3150			3153



PASTIGLIE FRENO RMS - SINTER (RICERCA PER MARCA)











RMS - SINTER BRAKE PADS (SEARCH BY BRAND)

CC	MODELLO MODEL	ANNO YEAR								
			 ANTERIORE - FRONT		 POSTERIORE - REAR		 ANTERIORE FRONT	 POSTERIORE REAR		
			PASTIGLIA ORGANICA - ORGANIC				PASTIGLIA SINTERIZZATA SINTERED			
			 OMOLOGATA HOMOLOGATED	 NON OMOLOGATA NOT HOMOLOGATED	 GANASCE BRAKE SHOES	 OMOLOGATA HOMOLOGATED	 NON OMOLOGATA NOT HOMOLOGATED	 GANASCE BRAKE SHOES		
			22 510		22 512	22 510		22512	22 510	22 510
750	K 75 750 S	>88	3150		3150		3153	3153		
800	F 800 Gs	08>	1010		1330		1013	1333		
800	F 800 R	09>	1100		1330		1103	1333		
800	F 800 S	06>	1100		1330		1103	1333		
800	F 800 St	06>	1100		1330		1103	1333		
800	F 800 St Touring	11>	1100		1330		1103	1333		
800	R 80 800 All Models	82>84	3150				3153			
800	R 80 800 All Models	85>89	3150				3153			
800	R 80 800 Gs/Paris-Dakar	81>86	3150				3153			
850	R 850 C	99>			1380			1383		
850	R 850 Gs	99>			1380			1383		
850	R 850 R	99>			1380			1383		
850	R 850 R	03>	2120		1380		3013	1383		
850	R 850 R Roadster	95>			1380			1383		
850	R 850 R Roadster	01>			1380		1603	1383		
850	R 850 Rt	98>00			1330			1333		
850	R 850 Rt Abs	01>			1380		1603	1383		
1000	K 1 1000	89>			3150			3153		
1000	K 100 1000 (Pinza Abs)	91>			3150			3153		
1000	K 100 1000 All Models	>88	3150		3150		3153	3153		
1000	K 100 1000 Lt	88>			3150			3153		
1000	K 100 1000 Rs	88>90			3150			3153		
1000	K 100 1000 Rs	90>			3150			3153		
1000	R 100 1000 All Models	81>89	3150				3153			
1000	R 100 1000 All Models	81>89	3150		3150		3153	3153		
1000	R 100 1000 Rs - Rt - Cs	81>			3150			3153		
1000	S 1000 Rr	09>			1330		3003	1333		
1000	S Rr Hp4	13					3333			
1100	K 1100 Rt (Abs)	00>			1380			1383		
1100	R 1100 Gs (Abs)	94>			1380			1383		
1100	R 1100 R	99>			0430					
1100	R 1100 R Roadster	95>00			1380			1383		
1100	R 1100 Rs (Abs)	94>			1380			1383		
1100	R 1100 Rt (Abs)	95>			1380			1383		
1100	R 1100 S	99>00			1380			1383		
1100	R 1100 S (No Abs)	01>			1380		1603	1383		
1100	R 1100 S Abs	01>	2120		1380		3013	1383		
1150	R 1150 Gs	00>			1380			1383		

PASTIGLIE FRENO RMS - SINTER (RICERCA PER MARCA)

RMS - SINTER BRAKE PADS (SEARCH BY BRAND)

















CC	MODELLO MODEL	ANNO YEAR	RMS YOUR BEST PARTNER				SINTER	
			 ANTERIORE - FRONT		 POSTERIORE - REAR		 ANTERIORE FRONT	 POSTERIORE REAR
			PASTIGLIA ORGANICA - ORGANIC				PASTIGLIA SINTERIZZATA SINTERED	
								
			OMOLOGATA HOMOLOGATED	NON OMOLOGATA NOT HOMOLOGATED	GANASCE BRAKE SHOES	OMOLOGATA HOMOLOGATED	NON OMOLOGATA NOT HOMOLOGATED	GANASCE BRAKE SHOES
22 510		22 512	22 510		22512	22 510	22 510	
1150	R 1150 R	01>	2120		1380		3013	1383
1150	R 1150 R Con Freno Integrale	01>	2120		1380		3013	1383
1150	R 1150 R Roadster	01>	2120		1380		3013	1383
1150	R 1150 Rs Con Freno Integrale	01>	2120		1380		3013	1383
1150	R 1150 Rt	01>	2120		1380		3013	1383
1200	Hp2 1200 Enduro	06>	1010		0430		1013	
1200	Hp2 1200 Megamoto	07>			1380		1603	1383
1200	Hp2 1200 Sport	08>			0430		2923	
1200	K 1200 Rs	97>00			3150			3153
1200	K 1200 Rs	01>04			3150			3153
1200	K 1200 Gt Abs Integrale	02>07					1603	
1200	K 1200 Gt Abs Integrale	08>			0430		1603	
1200	K 1200 Lt Abs Integrale	02>	2120				3013	
1200	K 1200 R	05>08	2120		1380		3013	1383
1200	K 1200 R Sport	07>	2120		1380		3013	1383
1200	K 1200 Rs	01>04					1603	
1200	K 1200 S	05>08			1380		1603	1383
1200	R 1200 C All Models	97>02			1380			1383
1200	R 1200 C Classic	03>04	2120		1380		3013	1383
1200	R 1200 C Indipendent	03>	2120		1380		3013	1383
1200	R 1200 C Motauk	04>	2120		1380		3013	1383
1200	R 1200 CL	03>	2120				3013	
1200	R 1200 Gs	04>			1380		1603	1383
1200	R 1200 Gs	13>					3193	
1200	R 1200 Gs Tripple Black	11>			1380		1603	1383
1200	R 1200 Lt Con Freno Integrale	02>	2120				3013	
1200	R 1200 R	05>08	2120		1380		3013	1383
1200	R 1200 R Sport	07>	2120		1380		3013	1383
1200	R 1200 Rt	06>			1380		1603	1383
1200	R 1200 S	06>			1380		1603	1383
1200	R 1200 St	06>			1380		1603	1383
1200	Hp2 Sport	08-10					3333	
1300	K 1300 Gt	09>			1380		1603	1383
1300	K 1300 R	09>	2120		1380		3013	1383
1300	K 1300 R Dynamic	11>	2120		1380		3013	1383
1300	K 1300 S	09>			1380		1603	1383
1600	K 1600 GT	11>	2120		1380		3013	1383
1600	K 1600 GTL	11>	2120		1380		3013	1383



PASTIGLIE FRENO RMS - SINTER (RICERCA PER MARCA)

RMS - SINTER BRAKE PADS (SEARCH BY BRAND)

CC	MODELLO MODEL	ANNO YEAR								
			 ANTERIORE - FRONT		 POSTERIORE - REAR		 ANTERIORE FRONT	 POSTERIORE REAR		
			PASTIGLIA ORGANICA - ORGANIC				PASTIGLIA SINTERIZZATA SINTERED			
			 OMOLOGATA HOMOLOGATED	 NON OMOLOGATA NOT HOMOLOGATED	 GANASCE BRAKE SHOES	 OMOLOGATA HOMOLOGATED	 NON OMOLOGATA NOT HOMOLOGATED	 GANASCE BRAKE SHOES		
			22 510		22 512	22 510		22512	22 510	22 510
BOMBARDIER ATV										
200	Rally 200 2X4	03>	0040							
330	Outlander 330 (Pinza Dx)	03>	2890		2870		2893	2873		
330	Outlander 330 (Pinza Sx)	03>	2870		2870		2873	2873		
400	Outlander 400 (Pinza Dx)	03>	2890		2870		2893	2873		
400	Outlander 400 (Pinza Sx)	03>	2870		2870		2873	2873		
500	Quest 500 (Pinza Dx)	02>	2890		2870		2893	2873		
500	Quest 500 (Pinza Sx)	02>	2870		2870		2873	2873		
500	Traxter 500 (Pinza Dx)	01>	2890		2870		2893	2873		
500	Traxter 500 (Pinza Sx)	01>	2870		2870		2873	2873		
500	Traxter 500 4X4	99>00	0490		0490		0493	0493		
650	Ds 650 (Pinza Dx)	00>01	2890		2870		2893	2873		
650	Ds 650 (Pinza Sx)	00>01	2870		2870		2873	2873		
650	Quest 650 (Pinza Dx)	02>	2890		2870		2893	2873		
650	Quest 650 (Pinza Sx)	02>	2870		2870		2873	2873		
BRANDY-BRAS										
50	Brandy 50	-					0061			
90	Brandy 90	-					0061			
BS VILLA										
50	Ax 50	93>	0180				0091			
50	Gz 50	93>	0180				0091			
50	Zx 50	93>	3240	0140						
BUELL										
500	Blast 500	01>09	0870		2610		0873	2613		
984	Xb9r 984 Firebolt	02>10			2610			2613		
984	Xb9s 984 Lightning	03>10			2610			2613		
984	Xb9sx 984 City X	05>10			2610			2613		
1200	M2 1200 Cyclone	98>02			2610			2613		
1200	Rs 1200 X 1	01>			2610			2613		
1200	S1 1200 Lightning	98>02			2610			2613		
1200	S1 1200 Whitelighning	98>02			2610			2613		
1200	S3 1200 Thunderbolt	98>02			2610			2613		
1200	X1 1200 Lightning	01>02			2610			2613		
1200	Xb12r 1200 Firebolt	04>08			2610			2613		
1200	Xb12r 1200 Firebolt	09>10			2610			2613		
1200	Xb12s 1200 Lightning	04>08			2610			2613		
1200	Xb12scg 1200 Lightning	06>08			2610			2613		
1200	Xb12scg 1200 Lightning	09>			2610			2613		

PASTIGLIE FRENO RMS - SINTER (RICERCA PER MARCA)

RMS - SINTER BRAKE PADS (SEARCH BY BRAND)

















CC	MODELLO MODEL	ANNO YEAR	RMS YOUR BEST PARTNER				SINTER	
			ANTERIORE - FRONT		POSTERIORE - REAR		ANTERIORE FRONT	POSTERIORE REAR
			PASTIGLIA ORGANICA - ORGANIC				PASTIGLIA SINTERIZZATA SINTERED	
			OMOLOGATA HOMOLOGATED	NON OMOLOGATA NOT HOMOLOGATED	GANASCE BRAKE SHOES	OMOLOGATA HOMOLOGATED	NON OMOLOGATA NOT HOMOLOGATED	GANASCE BRAKE SHOES
22 510		22 512	22 510		22512	22 510	22 510	
1200	Xb12scg 1200 Lightning	09>10			2610	2613		
1200	Xb12ss 1200 Lightning Long	06>08			2610	2613		
1200	Xb12ss 1200 Lightning Long	09>10			2610	2613		
1200	Xb12tt 1200 Super Tt	07>10			2610	2613		
1200	Xb12x 1200 Super Tt	06>10			2610	2613		
BULTACO								
50	Astro 50	01>	0740		0080	0083		
50	Lobito 50	98>	0740		0080	0083		
75	Lobito 75	99>	0740		0080	0083		
CAGIVA								
50	Blues 50	89>	0060		0020	0063		
50	City 50	92>94	3240	0140	0091			
50	City 50	95>	2750		0091		2753	
50	Cocis 50	88>	0010		0020	0013		
50	Cocis 50	89>	0010		0010			
50	Corsa 50	98>	0080				0083	
50	Cucciolo 50	97>	0010				0013	
50	Lucky Explorer 50	88>	0010		0020	0013		
50	Mantis 50	98>	0080		0130		0083	
50	Mito 50	98>	0060		0080	0063 0083		
50	Nuvola 50	00>	0010				0013	
50	Passing 50	95>	2750				2753	
50	Prima 50	92>	0210		0160			
50	Progress 50	97>	0080		0130		0083	
50	Supercity 50	93>			0010			
50	W4 Pro Action 50	94>	0010		0020	0013		
75	Elefant 750 Bifaro	90>			0740			
80	City 80	93>	0210		0160			
80	Cocis 80	89>	0010		0020	0013		
80	Prima 80	92>	0210		0160			
80	Supercity 80	94>			0010			
80	W4 Pro Action 80	94>	0010		0020	0013		
110	Passing 110 (Brasil)	-	2750				2753	
125	Aletta Oro Rs	86>	0020		0020			
125	Blues 125	88>92	0060		0010	0063 0013		
125	Blues 125	93>	0060		0020	0063		
125	Dakar	85>	0020					
125	Elefantre 125	87>	0010					



PASTIGLIE FRENO RMS - SINTER (RICERCA PER MARCA)

RMS - SINTER BRAKE PADS (SEARCH BY BRAND)

CC	MODELLO MODEL	ANNO YEAR								
			 ANTERIORE - FRONT		 POSTERIORE - REAR		 ANTERIORE FRONT	 POSTERIORE REAR		
			PASTIGLIA ORGANICA - ORGANIC				PASTIGLIA SINTERIZZATA SINTERED			
			 OMOLOGATA HOMOLOGATED	 NON OMOLOGATA NOT HOMOLOGATED	 GANASCE BRAKE SHOES	 OMOLOGATA HOMOLOGATED	 NON OMOLOGATA NOT HOMOLOGATED	 GANASCE BRAKE SHOES		
			22 510	22 512	22 510	22512	22 510	22 510		
125	Freccia 125	87>			0010			0013		
125	Freccia 125 C10	88>			0010			0013		
125	Freccia 125 C10 Anniversario	89>			0010			0013		
125	Freccia 125 C10 R	88>			0010			0013		
125	Freccia 125 C12 R	89>90			0010			0013		
125	Freccia 125 C12 R	91>			0010			0013		
125	Freccia 125 C9	88>			0010			0013		
125	K7 125 Enduro	91>			0010			0013		
125	Mito 125	91>			0010			0013		
125	Mito 125 Eddy	93>	0520		0010		0523	0013		
125	Mito 125 Eu2	05>	0520		0010		0523	0013		
125	Mito 125 Ev	94>03	0520		0010		0523	0013		
125	Mito 2 125 Production Racer	94>	0520		0010		0523	0013		
125	Nuvola 125	00>	0010				0013			
125	Passing 125	96>	2750				2753			
125	Planet 125	98>	0520				0523			
125	Raptor 125	03>	0520		0010		0523			
125	Roadster 125	94>	0060				0063			
125	Supercity 125	94>			0010					
125	W8 Pro Action 125	92>95			0010					
125	Wmx 125 Cross	86>	0010				0013			
125	Wr 125	93>	1420		1440		1423			
200	Elefant	85>98		0020						
200	Roadster 200	96>	0060				0063			
250	Ala Blu 250	83>	0010				0013			
250	Ala Rossa 250	83>	0010				0013			
250	Ala Verde 250	83>	0010				0013			
250	Sst 250	80>	0010				0013			
250	Sst 250 Ruota Integrale	>82	0010				0013			
250	Ssx 250	82>	0010				0013			
250	St 250	82>	0010				0013			
250	Sx 250	82>	0010				0013			
250	Wmx 250	>82	0010				0013			
250	Wmx 250 /1	83>	0010				0013			
250	Wrx 250	83>	0010				0013			
350	Ala Azzurra 350	83>	0010				0013			
350	Ala Azzurra 350 Gt	87>	0010				0013			
350	Ala Blu 350	83>	0010				0013			

PASTIGLIE FRENO RMS - SINTER (RICERCA PER MARCA)

RMS - SINTER BRAKE PADS (SEARCH BY BRAND)

















CC	MODELLO MODEL	ANNO YEAR	RMS YOUR BEST PARTNER				SINTER	
			ANTERIORE - FRONT		POSTERIORE - REAR		ANTERIORE FRONT	POSTERIORE REAR
			PASTIGLIA ORGANICA - ORGANIC				PASTIGLIA SINTERIZZATA SINTERED	
			OMOLOGATA HOMOLOGATED	NON OMOLOGATA NOT HOMOLOGATED	GANASCE BRAKE SHOES	OMOLOGATA HOMOLOGATED	NON OMOLOGATA NOT HOMOLOGATED	GANASCE BRAKE SHOES
22 510		22 512	22 510		22512	22 510	22 510	
350	Ala Rossa 350	83>	0010			0013		
350	Ala Rossa 350	88>	0010			0013		
350	Ala Verde 350	83>	0010			0013		
350	Elefant 350	85>			0010		0013	
350	Sst 350	81>	0010			0013		
350	Sst 350	82>	0010			0013		
350	Sx 350	82>	0010			0013		
350	T4 350 R - Er	87>	0010			0013		
350	W 12 350	92>			0010			
500	Canyon 500	99>	1420		1070	1423	1073	
500	River 500	00>	0520		0010	0523		
500	T4 500 E - Er	87>	0010			0013		
500	Wmx 500	84>	0010			0013		
600	Canyon 600	95>	1420		1070	1423	1073	
600	River 600	94>	0520		0010	0523		
650	Ala Azzurra 650	84>	0010		0010	0013		
650	Ala Azzurra 650 Gt	87>	0060		0010	0063	0013	
650	Elefant 650	85>			0010		0013	
650	Raptor 650	01>	1100		0490	1103	0493	
650	V-Raptor 650	01>	1100		0490	1103	0493	
750	Dakar 750	87>			0010		0013	
750	Elefant 750	87>			0010		0013	
750	Elefant 750	94>			0430			
900	900 Cat	93>	0870		2640 0890	0873	2643	
900	Canyon 900 ie	97>			1070		1073	
900	Elefant 900 ie- Gt - Ac	91>			1070		1073	
900	Gran Canyon 900	99>	0870		1070	0873	1073	
906	Elefant 906	90>			1070		1073	
1000	Navigator 1000	00>	0870		1070	0873	1073	
1000	Raptor 1000	00>	1100		0490	1103	0493	
1000	Raptor 1000 Xtra	02>	1100		0490	1103	0493	
1000	V-Raptor 1000	00>	1100		0490	1103	0493	
1000	X3-Raptor 1000	04>	2860		0490	2863	0493	
1000	X-Raptor 1000	03>	2860		0490	2863	0493	
CANNONDALE								
400	Mx 400	00>	0920		1790	0923		
440	C 440 R	03>	0920		1790	0923		
440	E 440 R/A	03>	0920		1790	0923		



PASTIGLIE FRENO RMS - SINTER (RICERCA PER MARCA)

RMS - SINTER BRAKE PADS (SEARCH BY BRAND)

CC	MODELLO MODEL	ANNO YEAR								
			 ANTERIORE - FRONT		 POSTERIORE - REAR		 ANTERIORE FRONT	 POSTERIORE REAR		
			PASTIGLIA ORGANICA - ORGANIC				PASTIGLIA SINTERIZZATA SINTERED			
			 OMOLOGATA HOMOLOGATED	 NON OMOLOGATA NOT HOMOLOGATED	 GANASCE BRAKE SHOES	 OMOLOGATA HOMOLOGATED	 NON OMOLOGATA NOT HOMOLOGATED	 GANASCE BRAKE SHOES		
			22 510	22 512	22 510	22512	22 510	22 510		
440	S 440	03>	0520		1790			0523		
440	X 440	03>	0920		1790			0923		
CANNONDALE ATV										
440	Blaze 440 (Pinza Dx)	03>	2890		2870			2893	2873	
440	Blaze 440 (Pinza Sx)	03>	2870		2870			2873	2873	
440	Cannibal 440 (Pinza Dx)	03>	2890		2870			2893	2873	
440	Cannibal 440 (Pinza Sx)	03>	2870		2870			2873	2873	
440	Glamis 440 (Pinza Dx)	03>	2890		2870			2893	2873	
440	Glamis 440 (Pinza Sx)	03>	2870		2870			2873	2873	
440	Moto 440 (Pinza Dx)	03>	2890		2870			2893	2873	
440	Moto 440 (Pinza Sx)	03>	2870		2870			2873	2873	
440	Speed 440 (Pinza Dx)	03>	2890		2870			2893	2873	
440	Speed 440 (Pinza Sx)	03>	2870		2870			2873	2873	
CCM										
404	Ds 404	03>04	0430		1330				1333	
404	Ds 404 Supermoto	03>04	0430		1330				1333	
404	E 404	03>04	0430		1330				1333	
450	Mx 450	08>	0430		1450				1453	
600	C 25 600	96>	0430		1330				1333	
600	Rs 600	01>	0430		1330				1333	
604	Sport 604 E	99>	0430		1330				1333	
604	Supermoto 604 E	99>	0430		1330				1333	
644	Ds 644	02>	0430		1330				1333	
644	R 30 644	02>	0430		1330				1333	
CH RACING										
50	Wsm 50 Motard	05>	0740		0080				0083	
50	Wxe 50 Enduro	05>	0740		0080				0083	
125	Wsm 125 Motard	05>	0740		0080				0083	
125	Wxe 125 Enduro	05>	0740		0080				0083	
CIMATTI										
50	Gringo 50	85>	0030							
CPI										
50	Baby 50 J	02>	0040				0061			
50	Gtr 50	02>	0360		0300			0363	0303	
50	Gtr 50	03>05	0490		0300			0493	0303	
50	Gts 50	02>03	0360		0300			0363	0303	
50	Hussar 50	01>02	0040				0061			
50	Hussar 50	03>05					0061			

PASTIGLIE FRENO RMS - SINTER (RICERCA PER MARCA)

RMS - SINTER BRAKE PADS (SEARCH BY BRAND)

















CC	MODELLO MODEL	ANNO YEAR								
			 ANTERIORE - FRONT		 POSTERIORE - REAR		 ANTERIORE FRONT	 POSTERIORE REAR		
			PASTIGLIA ORGANICA - ORGANIC				PASTIGLIA SINTERIZZATA SINTERED			
			 OMOLOGATA HOMOLOGATED	 NON OMOLOGATA NOT HOMOLOGATED	 GANASCE BRAKE SHOES	 OMOLOGATA HOMOLOGATED	 NON OMOLOGATA NOT HOMOLOGATED	 GANASCE BRAKE SHOES		
			22 510	22 512	22 510	22512	22 510	22 510		
50	Mars 50	01>02	0040			0061				
50	Oliver 50 All Models	03>05				0061				
50	Popcorn 50	02>	0040			0061				
50	Supercross 50	03>05	0080		0080	0083	0083			
50	Supermoto 50	03>05	0080		0080	0083	0083			
125	Gtr 125	02>	0360		0300	0363	0303			
125	Gts 125	02>03	0360		0300	0363	0303			
125	Prince 125	01>	3210							
125	Sahel 125	02>	0920		2630	0923	2633			
125	X-Large 125	02>03	0490		0490	0493	0493			
150	X-Large 150	02>03	0490		0490	0493	0493			
200	Gtr 200	02>	0360		0300	0363	0303			
200	Gts 200	02>03	0360		0300	0363	0303			
200	X-Large 200	02>03	0490		0490	0493	0493			
250	Xs 250	07>	3070			3073				
250	Xs 250 Power Quad	06>	0040							
CZ JAWA										
50	50 Minarelli	03>04	0080			0083				
50	Robby 50	03>04	0080			0083				
100	Robby 100	03>04	0080			0083				
125	Cz 125 2T	-	3150			3153				
125	Cz 125 Mx	-	3150			3153				
125	Chopper 125	03>04	0080			0083				
125	Dandy 125	03>04	0080		0080	0083	0083			
125	Sport 125	03>04	0080		0080	0083	0083			
125	Travel 125	03>04	0080			0083				
180	Cz 180	92>	3150			3153				
180	Cz 180	93>	0010				0013			
300	Trail 300	93>	3150			3153				
DAELIM										
50	A Four 50	06>	0580			0583				
50	Besbi 50	07>	2630			2633				
50	Bonita 50	09>	3240	0140						
50	Delfino 50	99>	1440							
50	E-Five 50	03>	1440							
50	Gz 50 G Message	98>	3240	0140						
50	History 50	01>	1440		1440					
50	Message 50 li	02>	1440							



PASTIGLIE FRENO RMS - SINTER (RICERCA PER MARCA)











RMS - SINTER BRAKE PADS (SEARCH BY BRAND)

CC	MODELLO MODEL	ANNO YEAR								
			 ANTERIORE - FRONT		 POSTERIORE - REAR		 ANTERIORE FRONT	 POSTERIORE REAR		
			PASTIGLIA ORGANICA - ORGANIC				PASTIGLIA SINTERIZZATA SINTERED			
			 OMOLOGATA HOMOLOGATED	 NON OMOLOGATA NOT HOMOLOGATED	 GANASCE BRAKE SHOES	 OMOLOGATA HOMOLOGATED	 NON OMOLOGATA NOT HOMOLOGATED	 GANASCE BRAKE SHOES		
			22 510	22 512	22 510	22512	22 510	22 510		
50	Se 50 Cordi	06>	1440							
50	S-Five 50	01>	1440		1440					
50	Sj 50 S Five	06>	3240	0140						
50	Tapo 50	99>	1440							
50	Vivo 50	99>	1440							
100	Altino 100	99>	1440							
100	Delfino 100	99>	1440							
110	City Ace 110	03>	2590				2593			
125	Altino 125	02>	1440							
125	Daystar 125	00>	2640	0890			2643			
125	Delfino 125	08>	0580				0583			
125	History 125	01>	1440		1440					
125	Message 125 li	02>	1440							
125	Nf 125	03>	1440							
125	Ns 125 li	00>	1440			0091				
125	Otello 125	99>	1440							
125	Otello 125	08>	0380		1440		0383			
125	Otello 125 Dlx	99>	1440		1440					
125	Roadwin 125	04>	2640	0890	0350		2643	0353		
125	Rocket 125	99>	2640	0890			2643			
125	S2 125	05>06	2640	0890			2643			
125	S2 125 Fi	07>	0380		1440		0383			
125	SI 125 U3 Fi	07>	0380		1440		0383			
125	U2 125 Fi	07>	0380		1440		0383			
125	VI 125 Daystar	00>	2640	0890			2643			
125	Vs 125 Evolution	95>	1440							
125	Vt 125 Evolution	00>	2640	0890			2643			
125	Vt 125 Magna	97>	2640	0890			2643			
150	Roadwin 150 X5	06>	2640	0890	0350		2643	0353		
250	Roadwin 250	08>	2640	0890	0350		2643	0353		
250	S2 250	06>	2640	0890	1440		2643			
250	St 250 Sector Quad	05>06	0040		3230					
DB MOTORS										
50	Pirat 50 Zz	00>	0010		0010		0013			
50	Sport 50 Zz	00>	0010				0013			
DERBI										
50	All Models 50 Con Freno A Disco	83>	0080				0083			
50	Atlantis 50	99>	0080				0083			

PASTIGLIE FRENO RMS - SINTER (RICERCA PER MARCA)

RMS - SINTER BRAKE PADS (SEARCH BY BRAND)

















CC	MODELLO MODEL	ANNO YEAR	RMS YOUR BEST PARTNER				SINTER	
			 ANTERIORE - FRONT		 POSTERIORE - REAR		 ANTERIORE FRONT	 POSTERIORE REAR
			PASTIGLIA ORGANICA - ORGANIC				PASTIGLIA SINTERIZZATA SINTERED	
								
			OMOLOGATA HOMOLOGATED	NON OMOLOGATA NOT HOMOLOGATED	GANASCE BRAKE SHOES	OMOLOGATA HOMOLOGATED	NON OMOLOGATA NOT HOMOLOGATED	GANASCE BRAKE SHOES
22 510		22 512	22 510		22512	22 510	22 510	
50	Atlantis 50 4T	04>	0080				0083	
50	Atlantis 50 Bullet	04>	0080				0083	
50	Atlantis 50 City	06>	0080				0083	
50	Atlantis 50 H20	01>	0080				0083	
50	Atlantis 50 Wave	01>	0080				0083	
50	Aventura 50	96>	0080				0083	
50	Black Devil 50	04>	0360		0080	0363	0083	
50	Coppa 50 Fdt	86>	0080				0083	
50	Coppa 50 Fdx	87>	0080				0083	
50	Drd Racing 50 R	05>	0360		0080	0363	0083	
50	Drd Racing 50 Sm	05>	0360		0080	0363	0083	
50	Ds 50 World Champion	88>	0080				0083	
50	Easy 50	96>	0010				0013	
50	Fd 50 Jumbo	85>	0080				0083	
50	Fds 50	86>	0080				0083	
50	Fenix 50	94>	0080		0080	0083	0083	
50	Furax 50	96>	0080		0080	0083	0083	
50	Gp 1 50	01>04	0080		0080	0083	0083	
50	Gp 1 50 Eu2	05>	0490		0080	0493	0083	
50	Gpr 50 Nude	04>	0490		0080	0493	0083	
50	Gpr 50 R	97>	0740		0080		0083	
50	Gpr 50 Racing	04>	0490		0080	0493	0083	
50	Gpr 50 Sport	96>	0070		0020			
50	Hunter 50	95>	0080			0130	0083	
50	Manhattan 50	99>	0080			0083		
50	Paddock 50 St	96>	0080			0130	0083	
50	Predator 50	98>	0080		0080	0083	0083	
50	Predator 50 0.2	99>	0080			0130	0083	
50	Progress 50	97>	0080			0083		
50	Record 50	98>	0080			0130	0083	
50	Sabana 50	90>	0080		0080	0083	0083	
50	Senda 50	94>	0080			0083		
50	Senda 50 L	99>	0080		0080	0083	0083	
50	Senda 50 R	94>04	0080		0080	0083	0083	
50	Senda 50 R Drd	03>04	0740		0080		0083	
50	Senda 50 Sm	99>	0080		0080	0083	0083	
50	Senda 50 Sm Drd Black Edition	03>	0360		0080	0363	0083	
50	Senda 50 Sm Drd Racing	03>04	0080		0080	0083	0083	



PASTIGLIE FRENO RMS - SINTER (RICERCA PER MARCA)

RMS - SINTER BRAKE PADS (SEARCH BY BRAND)

CC	MODELLO MODEL	ANNO YEAR								
			 ANTERIORE - FRONT		 POSTERIORE - REAR		 ANTERIORE FRONT	 POSTERIORE REAR		
			PASTIGLIA ORGANICA - ORGANIC				PASTIGLIA SINTERIZZATA SINTERED			
			 OMOLOGATA HOMOLOGATED	 NON OMOLOGATA NOT HOMOLOGATED	 GANASCE BRAKE SHOES	 OMOLOGATA HOMOLOGATED	 NON OMOLOGATA NOT HOMOLOGATED	 GANASCE BRAKE SHOES		
			22 510	22 512	22 510	22512	22 510	22 510		
50	Senda 50 Sm Drd Racing Ltd	05>	0080				0083			
50	Senda 50 X-Treme	94>04	0080		0080		0083	0083		
50	Sport Edition 50	95>	0080				0083			
50	St 50 Paddock	96>	0080				0083			
50	Stinger 50	96>	0080				0083			
50	Vamos 50	94>	0080				0083			
50	Vamos 50 R	95>	0190			0130	0193			
50	Vamos 50 R	96>	0080				0083			
50	Variant 50 Sport R	94>	0080				0083			
50	X-Race 50 R	05>	0080		0080		0083	0083		
50	X-Treme 50 R	05>	0080		0080		0083	0083		
75	Coppa 75 Sport	85>	0080				0083			
75	Gpr 75 Sport	90>	0070							
75	Tt8 75	84>	0010				0013			
75	Yumbo 75 Rd-2 Fds	87>	0080				0083			
80	Gpr 80 Cup	04>	0490		0080		0493	0083		
100	Atlantis 100 4T	04>	0080			0390	0083			
100	Atlantis 100 H20	01>	0080				0083			
125	Boulevard 125	02>04	2810			0421				
125	Gp1 125	06>08	0490		0080		0493	0083		
125	Gpr 125 4T	09>	3160				3163			
125	Gpr 125 Nude	04>06	3160		0080		3163	0083		
125	Gpr 125 Racing	04>06	3160		0080		3163	0083		
125	Mulhacen 125	07>	0360		0010		0363	0013		
125	Mulhacen 125	08					3343			
125	Predator 125	99>	0740							
125	Senda 125 R 4T	04>	0360		0080		0363	0083		
125	Senda 125 X-Treme Sm 4T	04>	0360		0080		0363	0083		
125	Terra	07>	0080		0080		0083	0083		
125	Terra	08					3343			
125	Terra Adventure	08					3343			
150	Atlantis 150	04>	2810							
150	Boulevard 150	02>04	2810			0421				
180	Predator 180	99>	0740							
200	Boulevard 200	05>	2810			0421				
250	Gp1 250	05>	0490		0450		0493	0453		
250	Rc 250	85>	0010				0013			
659	Mulhacen 659	05>			0490		2983	0493		

PASTIGLIE FRENO RMS - SINTER (RICERCA PER MARCA)

RMS - SINTER BRAKE PADS (SEARCH BY BRAND)

















CC	MODELLO MODEL	ANNO YEAR								
			 ANTERIORE - FRONT		 POSTERIORE - REAR		 ANTERIORE FRONT	 POSTERIORE REAR		
			PASTIGLIA ORGANICA - ORGANIC				PASTIGLIA SINTERIZZATA SINTERED			
			 OMOLOGATA HOMOLOGATED	 NON OMOLOGATA NOT HOMOLOGATED	 GANASCE BRAKE SHOES	 OMOLOGATA HOMOLOGATED	 NON OMOLOGATA NOT HOMOLOGATED	 GANASCE BRAKE SHOES		
			22 510	22 512	22 510	22512	22 510	22 510		
659	Mulhacen 659 Cafe'	08>	0490		2983	0493				
DUCATI										
250	250 Desmo	>77	3150		3153					
350	350 Desmo	>77	3150		3153					
350	350 F3	86>	0010	0010	0013	0013				
350	350 Indiana	87>		0010		0013				
350	350 S-GTL	75>	0010		0013					
350	350 Sport Gtv-SL-XL	75>	0010		0013					
400	400 Desmo F3	87>	0010	0010	0013					
400	Monster 400	01>	1100	0010	1103					
400	Ss 400 Junior	92>	0520	0010	0523					
400	Ss 400 Nuda	92>	0520	0010	0523					
500	500 Gtl Sport Desmo	75>	0010		0013					
500	500 Gtv	77>	0010		0013					
500	500 Pantah	77>	0010		0013					
500	S 500	75>	0010		0013					
502	502 Single	93>	0520	0010	0523	0013				
502	502 Supermono	93>	0520	0010	0523	0013				
550	550 Supermono	93>	0520	0010	0523	0013				
600	600 SL	76>	3150	3150	3153	3153				
600	600 TI Pantah	76>	3150	3150	3153	3153				
600	600 Supersport Carenata	94>	0520	0010	0523	0013				
600	600 Supersport Nuda	94>	0520	0010	0523	0013				
600	Monster 600	93>99	0520	0010	0523	0013				
600	Monster 600	00>01	1100	0010	1103	0013				
620	620 Sport	03>	1100	0490	1103	0493				
620	Monster 620 ie	02>	1100	0010	1103	0013				
620	Monster S 620	02>	1100	0010	1103	0013				
620	Multistrada 620	05>	1010	0490	1013	0493				
620	Multistrada 620 Dark	05>	1100	0490	1103	0493				
650	650 Desmo	87>	3150		3153					
650	650 Desmo	87>		0010		0013				
650	650 Indiana	86>	0010	0010		0013				
650	650 Indiana	87>		0010		0013				
695	Monster 695	07>	1010	0010	1013	0013				
696	Monster 696	08>	1100	0490	1103	0493				
748	748 Biposto	95>98	0520	0010	0523	0013				
748	748 R	00>	1100	0010	1103	0013				



PASTIGLIE FRENO RMS - SINTER (RICERCA PER MARCA)













RMS - SINTER BRAKE PADS (SEARCH BY BRAND)

CC	MODELLO MODEL	ANNO YEAR								
			 ANTERIORE - FRONT		 POSTERIORE - REAR		 ANTERIORE FRONT	 POSTERIORE REAR		
			PASTIGLIA ORGANICA - ORGANIC				PASTIGLIA SINTERIZZATA SINTERED			
			 OMOLOGATA HOMOLOGATED	 NON OMOLOGATA NOT HOMOLOGATED	 GANASCE BRAKE SHOES	 OMOLOGATA HOMOLOGATED	 NON OMOLOGATA NOT HOMOLOGATED	 GANASCE BRAKE SHOES		
			22 510		22 512	22 510		22512	22 510	22 510
748	748 R	01>02	2860		0010		2863	0013		
748	748 Racing Clienti	95>97			0010			0013		
748	748 Racing Clienti	98>	1100		0010		1103	0013		
748	748 S	99>02	1100		0010		1103	0013		
748	748 Sp	95>97	0520		0010		0523	0013		
748	748 Sps	98>99	1100		0010		1103	0013		
749	749 R	04>	2860		0490		2863	0493		
749	749 S	03>	2860		0490		2863	0493		
750	750 Endurance	87>			3150			3153		
750	750 F1 Desmo	86>	3150				3153			
750	750 Laguna Seca	87>			3150			3153		
750	750 Paso	87>	3150		3150		3153	3153		
750	750 Sport	88>90	3150		3150		3153	3153		
750	750 Sport	>76	3150				3153			
750	750 Ss	76>	3150		3150		3153	3153		
750	750 Endurance	87>	0520				0523			
750	750 F1 Desmo	86>			0010			0013		
750	750 Laguna Seca	87>	0520				0523			
750	750 Sport	00>	1100		0490		1103	0493		
750	750 Sport	>76			0010			0013		
750	750 Super Sport	91>94	0520		0010		0523	0013		
750	750 Supersport	92>97	0520		0010		0523	0013		
750	750 Supersport	98>	1100		0490		1103	0493		
750	Monster 750	96>99	0520		0010		0523	0013		
750	Monster 750	00>01	1100		0010		1103	0013		
750	Monster 750 ie	02>	1100		0010		1103	0013		
750	Ss 750 Super Sport	95>99	0520		0010		0523	0013		
750	Ss 750 Super Sport	00>	1100		0490		1103	0493		
796	Hypermotard 796	10>	1100		0490		1103	0493		
796	Monster 796	11>	1100		0490		1103	0493		
800	800 Sport	03>	1100		0490		1103	0493		
800	800 Supersport	03>	1100		0490		1103	0493		
800	Hypermotard 800	13>					3193			
800	Hypermotard 800 Sp	13>					3193			
800	Hyperstrada 800	13>					3193			
800	Monster 800 Dark ie	03>	1100		0010		1103	0013		
800	Monster S2r 800	05>	1010		0010		1013	0013		
848	848	08>10	1100		0490		1103	0493		

PASTIGLIE FRENO RMS - SINTER (RICERCA PER MARCA)

RMS - SINTER BRAKE PADS (SEARCH BY BRAND)

















CC	MODELLO MODEL	ANNO YEAR							
			 ANTERIORE - FRONT		 POSTERIORE - REAR		 ANTERIORE FRONT	 POSTERIORE REAR	
			PASTIGLIA ORGANICA - ORGANIC				PASTIGLIA SINTERIZZATA SINTERED		
									
			OMOLOGATA HOMOLOGATED	NON OMOLOGATA NOT HOMOLOGATED	GANASCE BRAKE SHOES	OMOLOGATA HOMOLOGATED	NON OMOLOGATA NOT HOMOLOGATED	GANASCE BRAKE SHOES	
22 510		22 512	22 510		22512	22 510	22 510		
848	848 Evo	11>				0490	2923	0493	
851	851 All Models	88>	0520			0010	0523	0013	
880	880 Racing	94>				0010		0013	
888	888 All Models	92>	0520			0010	0523	0013	
900	900 All Models	92>	0520			0010	0523	0013	
900	900 ie Paso	92>	0520			0010	0523	0013	
900	900 S	02>	1100			0490	1103	0493	
900	900 Sport	02>	1100			0490	1103	0493	
900	900 Sport Touring	99>	1100			0490	1103	0493	
900	900 Supermono Desmo 4	93>	0520			0010	0523	0013	
900	Mh 900	00>	1100			0490	1103	0493	
900	Monster 900	93>99	0520			0010	0523	0013	
900	Monster 900 ie	00>01	1100			0010	1103	0013	
900	Monster S4 900	02>	1100			0010	1103	0013	
900	Street Monster 900	94>99	0520			0010	0523	0013	
900	Supersport 900 Fe	98>	1100			0490	1103	0493	
906	906 Paso	89>	3150			3150	3153	3153	
916	916 Biposto	94>	1100			0010	1103	0013	
916	916 Racing Clienti	95>				0010		0013	
916	916 Sport Touring 4	99>03	1100			0490	1103	0493	
916	916 Sport Touring 4S	03>04	1100			0490	1103	0493	
916	916 Strada	94>97	0520			0010	0523	0013	
916	916 Strada	98>	1100			0490	1103	0493	
916	916 Supersport 4	98>	1100			0490	1103	0493	
916	Monster S4 916	01>03	1100			0010	1103	0013	
944	944 St2	97>00	1100			0490	1103	0493	
944	944 St4	99>	1100			0490	1103	0493	
944	944 Supersport 2	98>	1100			0490	1103	0493	
992	992 St3	04>	1100			0490	1103	0493	
992	992 St3 S Abs	06>	1100			0490	1103	0493	
996	996 R	01>	1100			0010	1103	0013	
996	996 R Testa Stretta	01>	2860			0490	2863	0493	
996	996 Sps - Rs	98>	1100			0490	1103	0493	
996	996 St4s	02>	1100			0490	1103	0493	
996	Monster S4r 996	04>	1100			0010	1103	0013	
998	998 Biposto	02>	1100			0010	1103	0013	
998	998 R	02>	2860			0490	2863	0493	
998	998 S - R	02>	1100			0010	1103	0013	



PASTIGLIE FRENO RMS - SINTER (RICERCA PER MARCA)











RMS - SINTER BRAKE PADS (SEARCH BY BRAND)

CC	MODELLO MODEL	ANNO YEAR								
			 ANTERIORE - FRONT		 POSTERIORE - REAR		 ANTERIORE FRONT	 POSTERIORE REAR		
			PASTIGLIA ORGANICA - ORGANIC				PASTIGLIA SINTERIZZATA SINTERED			
			 OMOLOGATA HOMOLOGATED	 NON OMOLOGATA NOT HOMOLOGATED	 GANASCE BRAKE SHOES	 OMOLOGATA HOMOLOGATED	 NON OMOLOGATA NOT HOMOLOGATED	 GANASCE BRAKE SHOES		
			22 510		22 512	22 510		22512	22 510	22 510
999	999 S - R	03>	2860		0490		2863	0493		
999	Monster S4r 999	07>	2860		0490		2863	0493		
999	Monster S4rs 999	07>	2860		0490		2863	0493		
1000	1000 All Models	84>	3150		3150		3153	3153		
1000	1000 Mille Replica	05>	3150		3150		3153	3153		
1000	1000 S2 Desmo	85>	3150		3150		3153	3153		
1000	1000 Biposto	07>	1010		1330		1013	1333		
1000	Desmosedici 1000 Rr	08>			0490		2923	0493		
1000	Gt 1000	07>10	1010		1330		1013	1333		
1000	Gt 1000 Touring	09>	1010		0490		1013	0493		
1000	Hypermotard 1000	06>	2860		0490		2863	0493		
1000	Monster 1000 Dark ie	03>	1100		0010		1103	0013		
1000	Monster 1000 ie	03>	1100		0010		1103	0013		
1000	Monster S2r 1000	06>	1100		0010		1103	0013		
1000	Multistrada 1000	07>	1100		0490		1103	0493		
1000	Multistrada 1000 Ds	03>06	1100		0490		1103	0493		
1000	Multistrada 1000 S Ds	05>06	1100		0490		1103	0493		
1000	Paul Smart 1000 L.e.	06>	1010		1330		1013	1333		
1000	Sport 1000	05>08	1010		1330		1013	1333		
1000	Sport 1000 S	07>09	1010		1330		1013	1333		
1000	Supersport 1000 Ds	03>	1100		0490		1103	0493		
1100	1098 1100 R	08>			0490		2923	0493		
1100	1098 1100 S	07>08			0490		2923	0493		
1100	1098 1100 S Tricolore	07>08			0490		2923	0493		
1100	Hypermotard 1100	07>09	1100		0490		1103	0493		
1100	Hypermotard 1100 Evo	10>	1100		0490		1103	0493		
1100	Hypermotard 1100 Evo Sp	10>			0490		2923	0493		
1100	Hypermotard 1100 S	07>09			0490		2923	0493		
1100	Monster 1100	09>	1100		0490		1103	0493		
1100	Monster 1100 Evo	11>	1100		0490		1103	0493		
1100	Monster S 1100	09>	1100		0490		1103	0493		
1100	Multistrada 1100	07>09	1100		0490		1103	0493		
1100	Multistrada 1100 S	07>09	1100		0490		1103	0493		
1100	Street Fighter 1100	09>			0490		2923	0493		
1100	Street Fighter 1100 S	09>			0490		2923	0493		
1198	1198 1200	09>			0490		2923	0493		
1198	1198 1200 R Corse	10>			0490		2923	0493		
1198	1198 1200 S	09>			0490		2923	0493		

PASTIGLIE FRENO RMS - SINTER (RICERCA PER MARCA)

RMS - SINTER BRAKE PADS (SEARCH BY BRAND)

















CC	MODELLO MODEL	ANNO YEAR	RMS YOUR BEST PARTNER				SINTER	
			 ANTERIORE - FRONT		 POSTERIORE - REAR		 ANTERIORE FRONT	 POSTERIORE REAR
			PASTIGLIA ORGANICA - ORGANIC				PASTIGLIA SINTERIZZATA SINTERED	
								
			OMOLOGATA HOMOLOGATED	NON OMOLOGATA NOT HOMOLOGATED	GANASCE BRAKE SHOES	OMOLOGATA HOMOLOGATED	NON OMOLOGATA NOT HOMOLOGATED	GANASCE BRAKE SHOES
22 510		22 512	22 510		22512	22 510	22 510	
1198	1198 1200 S Corse	10>			0490		2923	0493
1198	1198 1200 Sp	11>			0490		2923	0493
1200	Diavel 1200	11>			0430		2923	
1200	Multistrada 1200	10>	1100		0490		1103	0493
E-TON								
50	Rxl 50 Viper	03>05			0040			
70	Rxl 70 Viper	03>05			0040			
90	Rxl 90 Viper	03>05			0040			
150	Lxl / Clx 150 Challenger	03>05			1070			1073
150	Rxl 150 Viper	05>			1070			1073
150	Rxl 150 Viper	07>			3230			
150	St Exl 150 Viper	05>	0040		1070			1073
150	St Exl 150 Yukon	05>			1070			1073
250	Vxl 250 Vector - St Vector	06>	0040		3230			
300	Vtl 300 Vortex - St Vortex	07>	0040		3230			
300	Vxl 300 Vector - St Vector	07>	0040		3230			
FACTORY								
50	R12 50 Phantom Agua	06>	0650		0080			0083
50	R14 50 Phantom Agua	04>	0650		0080			0083
50	R14 50 Phantom Aire	03>	0080				0083	
50	Rp 50 Desert	04>	0360		0080		0363	0083
50	Sm 50 Chrono	04>	0360		0080		0363	0083
50	Sp 50 Chrono	04>	0360		0080		0363	0083
50	Yr 50 Desert	04>	0360		0080		0363	0083
65	R2 65 Phantom	04>	0650		0080			0083
100	100 Helix	04>			0040			
100	100 Rex	04>			0040			
125	Yr 125	06>	2590		0080		2593	0083
250	Yr 250	99>	0430		1330			1333
FACTORY ATV								
50	Helix 50	04>			0040			
50	Rex 50	04>			0040			
100	Helix 100	04>			0040			
100	Rex 100	04>			0040			
FANTIC								
50	Big Weel 50	94>	0180					
50	Caballero 50 Motard	10>	0920		0660		0923	0663
50	Caballero 50 Rc	90>	0010				0013	



PASTIGLIE FRENO RMS - SINTER (RICERCA PER MARCA)

RMS - SINTER BRAKE PADS (SEARCH BY BRAND)

CC	MODELLO MODEL	ANNO YEAR								
			 ANTERIORE - FRONT		 POSTERIORE - REAR		 ANTERIORE FRONT	 POSTERIORE REAR		
			PASTIGLIA ORGANICA - ORGANIC				PASTIGLIA SINTERIZZATA SINTERED			
			 OMOLOGATA HOMOLOGATED	 NON OMOLOGATA NOT HOMOLOGATED	 GANASCE BRAKE SHOES	 OMOLOGATA HOMOLOGATED	 NON OMOLOGATA NOT HOMOLOGATED	 GANASCE BRAKE SHOES		
			22 510		22 512	22 510		22512	22 510	22 510
50	Caballero 50 Regolarita'	10>	0920		0660		0923	0663		
50	Fast 50	88>	0070							
50	Grinta 50	95>	0180							
50	Issimo 50 (Ruote Raggi)	-		0191		0191				
50	Leader 50	95>	0180							
50	Mx 50 Regolarita' Casa	08>	0360		2630		0363	2633		
50	Mx 50 Regolarita' Competizione	08>	0920		2630		0923	2633		
50	Oasis 50 .1	86>	0070							
50	Oasis 50 .1 E.s.	87>	0070							
50	Oasis 50 .1 K.s.	87>	0070							
50	Oasis 50 .1 Kick	87>	0070							
50	Oasis 50 .1 Rally	86>	0070							
50	Pony 50	93>		0061		0061				
50	Pony 50 Sr	93>	0180				0061			
50	Queenie 50	95>	0180				0061			
50	Sprinter 50	84>		0201		0201				
50	Sprinter 50 3V. R (Fm. 248)	83>		0201		0201				
50	Supersei 50 Motard	08>	0360		2630		0363	2633		
50	Trial 50 .1 (Fm.268)	86>	0030							
50	Trial 50 .1 H2o	87>	0030							
50	Trial 50 .5	89>	0080		0080		0083	0083		
50	Trial 50 .7	90>	0080		0080		0083	0083		
50	Trial 50 .9	91>	0080		0080		0083	0083		
65	Mx 65 Regolarita' Competizione	08>	0920		2630		0923	2633		
85	Mx 85 Regolarita' Competizione	08>	0920		2630		0923	2633		
125	Mx 125 Regolarita' Casa	08>	0360		2630		0363	2633		
125	Supersei 125 Motard	08>	0360		2630		0363	2633		
125	Trial 125 .1 Progress 1	86>86	0030							
125	Trial 125 .1 Progress 2	86>	0030							
125	Trial 125 .3 Professional (Fm 361)	87>	0030		0030					
125	Trial 125 .5	89>	0080		0080		0083	0083		
125	Trial 125 .9	91>	0080		0080		0083	0083		
200	Trial 200 Progress 1	86>	0030							
200	Trial 201 Progress2	86>	0030							
240	Trial 240 (Fm 363)	87>	0030		0030					
241	Trial 241 Professional	86>	0030							
250	Coach 250	91>	0080				0083			
250	K-Roo 250	91>	0080		0080		0083	0083		

PASTIGLIE FRENO RMS - SINTER (RICERCA PER MARCA)

RMS - SINTER BRAKE PADS (SEARCH BY BRAND)

















CC	MODELLO MODEL	ANNO YEAR	RMS YOUR BEST PARTNER				SINTER			
			ANTERIORE - FRONT		POSTERIORE - REAR		ANTERIORE FRONT	POSTERIORE REAR		
			PASTIGLIA ORGANICA - ORGANIC				PASTIGLIA SINTERIZZATA SINTERED			
			OMOLOGATA HOMOLOGATED	NON OMOLOGATA NOT HOMOLOGATED	GANASCE BRAKE SHOES	OMOLOGATA HOMOLOGATED	NON OMOLOGATA NOT HOMOLOGATED	GANASCE BRAKE SHOES		
22 510		22 512	22 510		22512	22 510	22 510			
250	K-Roo 250	93>	0080		0080		0083	0083		
250	Raider 250 (Fm. 259)	85>	0060				0063			
250	Trial 249	90>	0080		0080		0083	0083		
300	Trial 305	89>	0080		0080		0083	0083		
300	Trial 307	90>91	0080		0080		0083	0083		
301	Trial 301 Progress 1 (Fm. 266)	85>	0030							
301	Trial 301 Progress 2	86>	0030							
303	Trial 303 (Fm 364)	87>84	0030		0030					
FB MINARELLI										
80	Mr 80	-	0080				0083			
GARELLI										
50	Basic 50 (Ruota Raggi)	-			0191		0191			
50	Big Wheel 50	93>	0180							
50	Cpr 50	02>	0180							
50	Eureka 50	-			0191		0191			
50	Flo' 50	00>	0190				0193			
50	Fx 50	02>	0180							
50	Grinta 50	95>	0180							
50	Gulp 50	-			0191		0191			
50	Junior 50 Turismo (Ruota Raggi)	-			0201		0201			
50	Krs 50	02>	2750				2753			
50	Noi 50 (Ruota Raggi)	-			0191		0191			
50	Noi 50 Matic	-			0191		0191			
50	Pony 50 Sr	92>	0180							
50	Queenie 50	95>	0180							
50	Sahel 50	91>	0070		0080			0083		
50	Starter 50	02>	0180							
50	Super Vip 50	-			0191		0191			
50	Tiger 50 XLE	86>	0070		0030					
50	Urka 50	91>	0010				0013			
50	Vip 50 (Ruota Raggi)	-			0191		0191			
80	Sahel 80	89>	0070		0080			0083		
125	Freeland 125	02>	2750				2753			
125	Panther 125	02>	3240	0140	0190			0193		
125	Raider 125	02>	0040							
125	Tiger 125 XLE	86>86	0060				0063			
125	Tiger 125 Xr	-	0010				0013			
125	Tiger 125 Xrd	-	0010				0013			



PASTIGLIE FRENO RMS - SINTER (RICERCA PER MARCA)











RMS - SINTER BRAKE PADS (SEARCH BY BRAND)

CC	MODELLO MODEL	ANNO YEAR								
			 ANTERIORE - FRONT		 POSTERIORE - REAR		 ANTERIORE FRONT	 POSTERIORE REAR		
			PASTIGLIA ORGANICA - ORGANIC				PASTIGLIA SINTERIZZATA SINTERED			
			 OMOLOGATA HOMOLOGATED	 NON OMOLOGATA NOT HOMOLOGATED	 GANASCE BRAKE SHOES	 OMOLOGATA HOMOLOGATED	 NON OMOLOGATA NOT HOMOLOGATED	 GANASCE BRAKE SHOES		
			22 510		22 512	22 510		22512	22 510	22 510
150	Freeland 150	02>	2750				2753			
150	Panther 150	02>	3240	0140	0190		0193			
250	Panther 250	02>	3240	0140	0190		0193			
320	Trial 320	86>	0080				0083			
125	Joker 2 125	02>	2590				2593			
150	Joker 2 150	02>	2590				2593			
GAS GAS										
50	Ec 50 Boy	01>	0630		0630					
50	Ec 50 Rookie	01>04	0740		0630					
50	Ec 50 Rookie	05>	0360		0640		0363			
50	Sm 50 Rookie	02>	0740		0630					
50	Txt 50 Boy	01>	0630		0630					
50	Txt 50 Boy	04>	0080		0080		0083	0083		
50	Txt 50 Rookie	02>03	0630		0630					
65	Mc 65	05>	0630		0630					
80	Endurcross 80	94>	0430		0060		0063			
80	Txt 80 Rookie	02>03	0630		0630					
125	Cross 125	94>	0430		0060		0063			
125	Delta 125	91>	0080				0083			
125	Ec 125	97>99	0430		1330		1333			
125	Ec 125	00>01	0920		2630		0923	2633		
125	Ec 125 Mx	02>07	0920		2630		0923	2633		
125	Ec 125 Sm	02>07	0520		2630		0523	2633		
125	Endurcross 125	94>	0430		0060		0063			
125	Jt 12 125	95>	0080		0080		0083	0083		
125	Mc 125	03>	0920		2630		0923	2633		
125	Pampera 125	96>03	0080		0080		0083	0083		
125	Pampera 125	04>	0360		0630		0363			
125	Sm 125	02>	0520		2630		0523	2633		
125	Trial 125	91>	0080		0080		0083	0083		
125	Tt 125	95>	0430		0080		0083			
125	Tt 125 Endurcross	93>	0430		0060		0063			
125	Txt 125	01>03	0630		0630					
125	Txt 125 Pro	04>09	0640		0650					
140	Jtr 140 Contact	96>	0080		0080		0083	0083		
150	Jt 16 150	95>	0080		0080		0083	0083		
160	Jt 160	95>	0080		0080		0083	0083		
200	Ec 200	99>	0430		1330		1333			

PASTIGLIE FRENO RMS - SINTER (RICERCA PER MARCA)

RMS - SINTER BRAKE PADS (SEARCH BY BRAND)

















CC	MODELLO MODEL	ANNO YEAR	RMS YOUR BEST PARTNER				SINTER	
			 ANTERIORE - FRONT		 POSTERIORE - REAR		 ANTERIORE FRONT	 POSTERIORE REAR
			PASTIGLIA ORGANICA - ORGANIC				PASTIGLIA SINTERIZZATA SINTERED	
								
			OMOLOGATA HOMOLOGATED	NON OMOLOGATA NOT HOMOLOGATED	GANASCE BRAKE SHOES	OMOLOGATA HOMOLOGATED	NON OMOLOGATA NOT HOMOLOGATED	GANASCE BRAKE SHOES
22 510		22 512	22 510		22512	22 510	22 510	
200	Ec 200	00>01	0920		2630		0923	2633
200	Ec 200 Mx	02>07	0920		2630		0923	2633
200	Ec 200 Sm	02>07	0520		2630		0523	2633
200	Pampera 200	99>	0080		0080		0083	0083
200	Tx 200	97>	0080		0080		0083	0083
200	Txt 200	00>03	0630		0630			
200	Txt 200 Pro	04>09	0640		0650			
249	Txt 249	01>	0630		0630			
250	Cross 250	95>	0430		1200			
250	Ec 250	97>99	0430		1330			1333
250	Ec 250	98>00	0430		1330			1333
250	Ec 250	00>01	0920		2630		0923	2633
250	Ec 250 Mx	01>07	0920		2630		0923	2633
250	Ec 250 Mx	02>07	0920		2630		0923	2633
250	Ec 250 Sm	02>07	0520		2630		0523	2633
250	Endurcross 250	95>	0430					
250	Jt 25 250	91>	0080		0080		0083	0083
250	Jt 250 Contact	94>	0080		0080		0083	0083
250	Jtr 250 Contact	96>	0080		0080		0083	0083
250	Mc 250	97>99	0430		1330			1333
250	Mc 250	00>	0920		2630		0923	2633
250	Pampera 250	96>99	0080		0080		0083	0083
250	Pampera 250	02>	0360		0630		0363	
250	Sm 250	02>	0520		2630		0523	2633
250	T 25 250 Contact	93>	0080		0080		0083	0083
250	Tt 250	95>	0430		1330			1333
250	Txt 250	00>03	0630		0630			
250	Txt 250 Pro	04>09	0640		0650			
270	Jtr 270 Contact	96>	0080		0080		0083	0083
270	Tx 270	>99	0080		0080		0083	0083
280	Pampera 280	04>	0360		0630		0363	
280	Txt 280	00>03	0630		0630			
280	Txt 280	04>09	0640		0650			
300	Ec 300	98>00	0430		1330			1333
300	Ec 300	01>	0920		2630		0923	2633
300	Ec 300 Sm	02>07	0520		2630		0523	2633
300	Txt 300	04>09	0640		0650			
320	Jt 32 320	91>	0080		0080		0083	0083



PASTIGLIE FRENO RMS - SINTER (RICERCA PER MARCA)

RMS - SINTER BRAKE PADS (SEARCH BY BRAND)

CC	MODELLO MODEL	ANNO YEAR								
			 ANTERIORE - FRONT		 POSTERIORE - REAR		 ANTERIORE FRONT	 POSTERIORE REAR		
			PASTIGLIA ORGANICA - ORGANIC				PASTIGLIA SINTERIZZATA SINTERED			
			 OMOLOGATA HOMOLOGATED	 NON OMOLOGATA NOT HOMOLOGATED	 GANASCE BRAKE SHOES	 OMOLOGATA HOMOLOGATED	 NON OMOLOGATA NOT HOMOLOGATED	 GANASCE BRAKE SHOES		
			22 510		22 512	22 510		22512	22 510	22 510
321	Txt 321	00>	0630		0630					
325	Halley 325 Pcx	87>	0080		0080		0083	0083		
327	Gt 327 Contact	-	0080		0080		0083	0083		
327	Trial 327	89>	0080		0080		0083	0083		
350	Gasgas 350	-	0080		0080		0083	0083		
350	Jt 350	95>	0080		0080		0083	0083		
370	Jtr 370 Contact	96>	0080		0080		0083	0083		
370	Pampera 370	96>	0080		0080		0083	0083		
400	Fse 400 Ec	01>07	0920		2630		0923	2633		
400	Fse 400 Sm	02>07	0520		2630		0523	2633		
450	Fse 450 Ec	03>07	0520		2630		0523	2633		
450	Fsr 450 Ec	08>	0920		2630		0923	2633		
450	Fsr 450 Sm	08>	0520		2630		0523	2633		
450	Pampera 450	07>08	0920		2630		0923	2633		
510	Fsr 510	08>	0920		2630		0923	2633		
GAS GAS ATV										
50	Wild 50 Hp	04>	0430		0430					
240	Wild 240 Hp	04>	0430		0430					
300	Wild 300 Hp	03>	0430		0430					
450	Wild 450 Hp	03>	0430		0430					
GENERIC										
50	Ideo 50	05>				0061				
50	Toxic 50	07>	0360		0190		0363	0193		
50	Trigger 50 Sm	06>	0360		0190		0363	0193		
50	Trigger 50 Sm Competition	08>	0360		0190		0363	0193		
50	Trigger 50 X	06>	0360		0190		0363	0193		
50	Trigger 50 X Competition	08>	0360		0190		0363	0193		
50	Xor 50	05>				0061				
125	Ideo 125	05>				0061				
125	Xor 125	05>				0061				
125	Zion 125	08>	0580				0583			
GILERA										
50	503 50	91>	0030		0030					
50	Bullit 50	90>	0030							
50	Cb 1 50	-		0191		0230				
50	Cba 50	-		0191		0230				
50	Cba 50	86>		0191		0230				
50	Dna 50	05>07	2620				2623			

PASTIGLIE FRENO RMS - SINTER (RICERCA PER MARCA)

RMS - SINTER BRAKE PADS (SEARCH BY BRAND)

















CC	MODELLO MODEL	ANNO YEAR	RMS YOUR BEST PARTNER				SINTER	
			ANTERIORE - FRONT		POSTERIORE - REAR		ANTERIORE FRONT	POSTERIORE REAR
			PASTIGLIA ORGANICA - ORGANIC				PASTIGLIA SINTERIZZATA SINTERED	
			OMOLOGATA HOMOLOGATED	NON OMOLOGATA NOT HOMOLOGATED	GANASCE BRAKE SHOES	OMOLOGATA HOMOLOGATED	NON OMOLOGATA NOT HOMOLOGATED	GANASCE BRAKE SHOES
22 510		22 512	22 510		22512	22 510	22 510	
50	Eaglet 50	96>	0070					
50	Easy Moving 50	95>	0190			0301	0193	
50	Easy Moving 50	98>	0190			0360		
50	Eco 50	-	0191			0230		
50	Gsm 50	99>	0080		0080	0083	0083	
50	H@C 50	99>	0080		0080	0083	0083	
50	Ice 50	02>	0190			0193		
50	Runner 50	97>	0190			0351	0193	
50	Runner 50 Pure Jet Race	06>08	2620		0300	2623	0303	
50	Runner 50 Pure Jet St	08>	2620		0300	2623	0303	
50	Runner 50 Sp	98>	0190		0300	0193	0303	
50	Runner 50 Sp Race	06>	2620		0300	2623	0303	
50	Runner 50 Sp Sc	06>07	2620		0300	2623	0303	
50	Runner 50 Sp St	08>	2620		0300	2623	0303	
50	Stalker 50	05>08	2800					
50	Stalker 50	97>04	0190		0300	0193	0303	
50	Stalker 50 Naked	08>	2800					
50	Stalker 50 Special Edition	07>08	2800					
50	Storm 50	94>95	0190			0301	0193	
50	Storm 50	96>	0260			0360		
50	Storm 50 Eu2	07>	2800					
50	Supermotard 50	01>	0080		0080	0083	0083	
50	Surfer 50	99>	0080			0083		
50	Trend 50	89>	0201			0230		
50	Typhoon 50	93>95	0190			0301	0193	
50	Typhoon 50	96>	0190			0360	0193	
50	Typhoon 50 Catalyzed	02>	0190		0190	0193	0193	
50	Typhoon X 50	98>99	0190			0360		
50	Zulu 50	01>	0080		0080	0083	0083	
80	Typhoon 80	95>	0190			0301	0193	
125	Apache 125	91>			2730 1430			
125	Arizona 125	83>	0010			0013		
125	Arizona Hawk 125	86>	0060			0063		
125	Cmm Apts 125	87>	0060		0010	0063		
125	Crono 125	91>	0530		0010	0533		
125	Cx 125	91>	0530		0010	0533		
125	Er 125	87>	0060			0063		
125	Fast Bike 125	87>	0060		0010	0063		



PASTIGLIE FRENO RMS - SINTER (RICERCA PER MARCA)

RMS - SINTER BRAKE PADS (SEARCH BY BRAND)

CC	MODELLO MODEL	ANNO YEAR								
			 ANTERIORE - FRONT		 POSTERIORE - REAR		 ANTERIORE FRONT	 POSTERIORE REAR		
			PASTIGLIA ORGANICA - ORGANIC				PASTIGLIA SINTERIZZATA SINTERED			
			 OMOLOGATA HOMOLOGATED	 NON OMOLOGATA NOT HOMOLOGATED	 GANASCE BRAKE SHOES	 OMOLOGATA HOMOLOGATED	 NON OMOLOGATA NOT HOMOLOGATED	 GANASCE BRAKE SHOES		
			22 510		22 512	22 510		22512	22 510	22 510
125	Gfr 125	93>	0530		0010		0533			
125	Gsm 125	00>	0080				0083			
125	Hx 125 Lc	83>	0010				0013			
125	Kk 125 Apts	87>	0060		0010		0063	0013		
125	Kz 125	86>	0060		0010		0063	0013		
125	Kz 125 Endurance	88>	0060		0010		0063	0013		
125	Mx 1 125	88>	0530		0010		0533	0013		
125	Mx R 125	90>	0530		0010		0533	0013		
125	Nexus 125 Eu3	07>08	2620		2620		2623	2623		
125	Nexus 125 ie Eu3	08>09	2620		2620		2623	2623		
125	R1 125 S	88>	0060		0010		0063	0013		
125	Rc 125 Rally	87>	0060				0063			
125	Rc 125 Top Rally	89>			2730	1430				
125	Rrt 125 Nebraska	87>	0060				0063			
125	Rrt 125 Nebraska (Ruote Tubles)	87>	0060				0063			
125	Rtx 125	-	0060				0063			
125	Runner 125	>99	0360			0421	0363			
125	Runner 125 (Pinza Heng Tong)	02>	2620		0450		2623	0453		
125	Runner 125 4T	05>06	2620		0450		2623	0453		
125	Runner 125 Fx - Sp	00>	0360		0300		0363	0303		
125	Runner 125 Vx / Vxr 4T	01>04	0360		0450		0363	0453		
125	Runner 125 Vx 4T Eu3	07>	2620		0450		2623	0453		
125	Runner 125 Vx 4T Race	06>07	2620		0450		2623	0453		
125	Runner 125 Vx 4T Sc	06>07	2620		0450		2623	0453		
125	Runner 125 Vx 4T St Eu3	08>	2620		0450		2623	0453		
125	Rv 125 Es	87>	0060				0063			
125	Rx 125	84>	0010				0013			
125	Sp 01 125	89>	0530		0010		0533	0013		
125	Sp 02 125	90>	0530		0010		0533	0013		
125	Surfer 125	00>	0080				0083			
125	Typhoon 125	95>	0190			0351	0193			
125	Typhoon 125 Xr Kat	00>	0190			0351	0193			
125	Xr1 125	88>	0060		0010		0063	0013		
125	Xr2 125	89>	0060		0010		0063	0013		
175	Mad Mud 175	02>	0360		0190		0363	0193		
180	Dna 180	01>	0360		0190		0363	0193		
180	Runner 180	>98	0360			0421	0363			
180	Runner 180 (Pinza Heng Tong)	02>	2620		0450		2623	0453		

PASTIGLIE FRENO RMS - SINTER (RICERCA PER MARCA)

RMS - SINTER BRAKE PADS (SEARCH BY BRAND)

















CC	MODELLO MODEL	ANNO YEAR	RMS YOUR BEST PARTNER				SINTER			
			ANTERIORE - FRONT		POSTERIORE - REAR		ANTERIORE FRONT	POSTERIORE REAR		
			PASTIGLIA ORGANICA - ORGANIC				PASTIGLIA SINTERIZZATA SINTERED			
			OMOLOGATA HOMOLOGATED	NON OMOLOGATA NOT HOMOLOGATED	GANASCE BRAKE SHOES	OMOLOGATA HOMOLOGATED	NON OMOLOGATA NOT HOMOLOGATED	GANASCE BRAKE SHOES		
22 510		22 512	22 510		22512	22 510	22 510			
180	Runner 180 Fxr - Sp	99>	0360		0300		0363	0303		
200	Arizona Hawk 200	86>	0060				0063			
200	Er 200	87>	0060				0063			
200	Fast Bike 200	87>	0060		0010		0063	0013		
200	Rtx 200	86>	0060				0063			
200	Runner 200 Vx / Vxr 4T	02>	0360		0450		0363	0453		
200	Runner 200 Vxr 4T	05>06	2620		0450		2623	0453		
200	Runner 200 Vxr 4T Race	06>	2620		0450		2623	0453		
200	Runner 200 Vxr 4T St Eu3	08>	2620		0450		2623	0453		
200	Runner 200 Vxr Eu3	07>	2620		0450		2623	0453		
200	Rv 200	85>			0010			0013		
200	Rv 200 Es	87>	0060		0010		0063	0013		
200	Rx 200	85>	0010							
200	Rx 200 Arizona	85>	0010							
250	Hx 250 Lc	83>	0010							
250	Nexus 250 Eu3	06>07	2620		2620		2623	2623		
250	Nexus 250 Sp Eu3	06>07	2620		2620		2623	2623		
250	Ngr 250	85>			0010			0013		
250	Rc 250 Rally	87>	0060		0010		0063	0013		
250	Rx 250 Arizona Rally	86>	0010				0013			
300	Nexus 300 Eu3	08>	2620		2620		2623	2623		
350	Dakota 350	86>	0060				0063			
350	Er 350	87>	0060				0063			
350	Xrt 350	90>	0060		0010		0063	0013		
500	Dakota 500	87>	0060				0063			
500	Er 500	87>	0060				0063			
500	Fuoco 500	07>08	0300		2620		0303	2623		
500	Nexus 500	03>05	0430		0490			0493		
500	Nexus 500 Eu3	06>08	0430		0490			0493		
500	Nexus 500 Sp Eu3	06>07	0430		0490			0493		
500	Saturno 500 Piuma	90>	0520		0010		0523	0013		
600	Rc 600	89>90			2730	1430				
600	Rc 600	91>			2730	1430				
600	Rc 600 Northwest	90>	0530				0533			
600	Rc 600 R	91>			2730	1430				
600	Rc 600 Top Rally	90>			2730	1430				
600	Supersport 600	02>	2860		0490		2863	0493		
600	Xrt 600	88>	0060		0010		0063	0013		
800	Gp 800	08>	0430		2620			2623		



PASTIGLIE FRENO RMS - SINTER (RICERCA PER MARCA)















RMS - SINTER BRAKE PADS (SEARCH BY BRAND)

CC	MODELLO MODEL	ANNO YEAR	 YOUR BEST PARTNER							
			 ANTERIORE - FRONT		 POSTERIORE - REAR		 ANTERIORE FRONT	 POSTERIORE REAR		
			PASTIGLIA ORGANICA - ORGANIC				PASTIGLIA SINTERIZZATA SINTERED			
			 OMOLOGATA HOMOLOGATED	 NON OMOLOGATA NOT HOMOLOGATED	 GANASCE BRAKE SHOES	 OMOLOGATA HOMOLOGATED	 NON OMOLOGATA NOT HOMOLOGATED	 GANASCE BRAKE SHOES		
			22 510	22 512	22 510	22512	22 510	22 510		
HARLEY DAVIDSON										
500	Xg Street	14					3403	3403		
750	Xg Street	15					3403	3403		
883	XL C Sportster Custom	04>13					3383	3393		
883	XL L Sportsler Low	06>13					3383	3393		
883	XL L Super Low	11>13					3383	3393		
883	XL N Iron	13					3383	3393		
883	XL R Roadster	10>13					3383	3393		
883	XL R Sportster	00>03					3373	3373		
883	XL Sportster	04>13					3383	3393		
883	XL Sportster R	05>13					3383	3393		
883	XL Sprtster Custom	00>03					3373	3373		
883	XLh Sportster	00>03					3373	3373		
883	XLh Sportster Hugger	00>03					3373	3373		
1130	Vrsc V-Road	02>05					3373	3373		
1130	Vrsc V-Rod	06					3423	3423		
1130	Vrscb V-Road	04					3373	3373		
1130	Vrscd Night Rod	06					3423	3423		
1130	Vrscr Street Rod	06					3423	3423		
1200	N Nightster	07					3383	3393		
1200	X Forty-Eight	11>13					3383	3393		
1200	XL C Sportster Custom	04					3383	3393		
1200	XL L Sportster Low	07					3383	3393		
1200	XL R Sportster Roadster	04					3383	3393		
1200	XL Sportster Custom	00>03					3373	3373		
1200	XL Sportster Sport	00>03					3373	3373		
1200	XL V Seventy-Two	11>13					3383	3393		
1200	XLh Sportster	00>03					3373	3373		
1200	Xr	08					-	3393		
1200	Xr X	10					3413	3393		
1250	Vrscaw V-Rod	08					3423	3423		
1250	Vrscdx Night Rod Special	08					3423	3423		
1250	Vrscf Muscle	09					3423	3423		
1250	Vrscx V-Rod	08					3423	3423		
1450	Flhr/I Road King	00>06					3373	3373		
1450	Flhrci Road King Classic	00>04					3373	3373		
1450	Flhrci Road King Classic	05>06					3373	3373		

PASTIGLIE FRENO RMS - SINTER (RICERCA PER MARCA)

RMS - SINTER BRAKE PADS (SEARCH BY BRAND)

















CC	MODELLO MODEL	ANNO YEAR								
			 ANTERIORE - FRONT		 POSTERIORE - REAR		 ANTERIORE FRONT	 POSTERIORE REAR		
			PASTIGLIA ORGANICA - ORGANIC				PASTIGLIA SINTERIZZATA SINTERED			
			 OMOLOGATA HOMOLOGATED	 NON OMOLOGATA NOT HOMOLOGATED	 GANASCE BRAKE SHOES	 OMOLOGATA HOMOLOGATED	 NON OMOLOGATA NOT HOMOLOGATED	 GANASCE BRAKE SHOES		
			22 510		22 512		22 510		22 512	
1450	Flhrs/I Road King Custom	04						3373	3373	
1450	Flhrs/I Road King Custom	05>06						3373	3373	
1450	Flht/I Electra Glide Standard	00>04						3373	3373	
1450	Flht/I Electra Glide Standard	05>06						3373	3373	
1450	Flhtc/I Electra Glide Standard	00>06						3373	3373	
1450	Flhtcui Ultra Classic Electra Glide	00>04						3373	3373	
1450	Flhtcui Ultra Classic Electra Glide	05>06						3373	3373	
1450	Flhxi Street Glide	06						3373	3373	
1450	Flsfti Fat Boy	06						3373	3373	
1450	Flstc Softail	06>07						3373	3373	
1450	Flstc/I Heritage Softail Classic	00>04						3373	3373	
1450	Flstci Softail	06						3373	3373	
1450	Flstf Fat Boy	06>07						3373	3373	
1450	Flstf/I Fat Boy	00>04						3373	3373	
1450	Flsti Heritage Softail	06						3373	3363	
1450	Flstn/I Softail Deluxe	06						3373	3373	
1450	Flsts/I Heritage Springer	00>03						-	3373	
1450	Flstsc/I Springer Softail Classic	06						-	3373	
1450	Fltr/I Road Glide Classic	00>06						3373	3373	
1450	Fxd Dyna Super Glide	00>03						3373	3373	
1450	Fxdbidyna Street Bob	06						3373	3373	
1450	Fxdc/I Dyna Super Glide Custom	05>06						3373	3373	
1450	Fxdi 35Th Anniversary Super Glide	06						3373	3363	
1450	Fxdi Dyna Super Glide	04						3373	3373	
1450	Fxdi Dyna Super Glide	05>06						3373	3373	
1450	Fxdl Dyna Low Rider	00>03						3373	3373	
1450	Fxdl Dyna Low Rider	04						3373	3373	
1450	Fxdl Dyna Low Rider	05>06						3373	3373	
1450	Fxds Dyna Convertible	00>02						3373	3373	
1450	Fxdwg Dyna Wide Glide	00>03						3373	3373	
1450	Fxdwgi Dyna Wide Glide	04						3373	3373	
1450	Fxdwgi Dyna Wide Glide	05>06						3373	3373	
1450	Fxdx Dyna Super Glide Sport	00>03						3373	3373	
1450	Fxdxi Dyna Super Glide Sport	04						3373	3373	
1450	Fxdxi Dyna Super Glide Sport	05>06						3373	3373	
1450	Fxdxt Dyna Super Glide T-Sport	00>03						3373	3373	
1450	Fxst/I Softail Standard	00>04						3373	3373	
1450	Fxst/I Softail Standard	05						3373	3373	



PASTIGLIE FRENO RMS - SINTER (RICERCA PER MARCA)















RMS - SINTER BRAKE PADS (SEARCH BY BRAND)

CC	MODELLO MODEL	ANNO YEAR								
			 ANTERIORE - FRONT		 POSTERIORE - REAR		 ANTERIORE FRONT	 POSTERIORE REAR		
			PASTIGLIA ORGANICA - ORGANIC				PASTIGLIA SINTERIZZATA SINTERED			
			 OMOLOGATA HOMOLOGATED	 NON OMOLOGATA NOT HOMOLOGATED	 GANASCE BRAKE SHOES	 OMOLOGATA HOMOLOGATED	 NON OMOLOGATA NOT HOMOLOGATED	 GANASCE BRAKE SHOES		
			22 510	22 512	22 510	22512	22 510	22 510		
1450	Fxst/I Softail Standard	06					3373	3363		
1450	Fxstb/I Night Train	06					3373	3363		
1450	Fxstb/I Night Train	00>04					3373	3373		
1450	Fxstb/I Night Train	05					3373	3373		
1450	Fxstd/I Softail Deuce	00>04					3373	3373		
1450	Fxstd/I Softail Deuce	05					3373	3373		
1450	Fxstd/I Softail Deuce	06					3373	3363		
1450	Fxsts/I Softail	05					-	3373		
1450	Fxsts/I Softail	06					-	3363		
1450	Fxsts/I Springer Softail	00>04					-	3373		
1584	Flhr Road King	07					3373	3373		
1584	Flhr Road King	08>10					3423	3423		
1584	Flhrc Road King Classic	07					3373	3373		
1584	Flhrc Road King Classic	08					3423	3423		
1584	Flhrs Road King Custom	07					3373	3373		
1584	Flht Electra Glide Standard	07					3373	3373		
1584	Flht Electra Glide Standard	08					3423	3423		
1584	Flhtc Electra Glide Classic	07					3373	3373		
1584	Flhtc Electra Glide Classic	08					3423	3423		
1584	Flhtci Ultra Electra Glide Classic	08					3423	3423		
1584	Flhtcui Ultra Classic Electra Glide	07>10					3373	3373		
1584	Flhtk Electra Glide Ultra Ltd	10					3423	3423		
1584	Flhx Street Glide	08					3423	3423		
1584	Flhxi Street Glide	07					3373	3373		
1584	Flstc Heritage Softail Classic	06					-	3363		
1584	Flstc Heritage Softail Classic	07					3373	-		
1584	Flstf Fat Boy	07					3373	3363		
1584	Flstn Softail Deluxe	07					3373	3363		
1584	Flstsc/I Softail	07					-	3363		
1584	Fltr Road Glide	08					3423	3423		
1584	Fltru Road Glide Ultra	11					3423	3423		
1584	Fltrx Road Glide Custom	10					3423	3423		
1584	Fxd Dyna Super Glide	07					3373	3373		
1584	Fxdb Dyna Street Bob	07					3373	3373		
1584	Fxdc Dyna Super Glide Custom	07					3373	3373		
1584	Fxdwg Dyna Wide Glide	07					3373	3373		
1584	Fxkl Dyna Low Rider	07					3373	3373		
1584	Fxst Softail Standard	07					3373	3363		

PASTIGLIE FRENO RMS - SINTER (RICERCA PER MARCA)

RMS - SINTER BRAKE PADS (SEARCH BY BRAND)

















CC	MODELLO MODEL	ANNO YEAR								
			 ANTERIORE - FRONT		 POSTERIORE - REAR		 ANTERIORE FRONT	 POSTERIORE REAR		
			PASTIGLIA ORGANICA - ORGANIC				PASTIGLIA SINTERIZZATA SINTERED			
			 OMOLOGATA HOMOLOGATED	 NON OMOLOGATA NOT HOMOLOGATED	 GANASCE BRAKE SHOES	 OMOLOGATA HOMOLOGATED	 NON OMOLOGATA NOT HOMOLOGATED	 GANASCE BRAKE SHOES		
			22 510		22 512	22 510		22512	22 510	22 510
1584	Fxstb Night Train	07					3373	3363		
1584	Fxstc Softail Custom	07					3373	3363		
1584	Fxstd Softail Deuce	07					3373	3363		
1690	Flhr Road King	11					3423	3423		
1690	Flhtcu Ultra Classic Electra Glide	11					3423	3423		
1690	Flhtcul Electra Glide Ultra Classic Low	15					3423	3423		
1690	Flhtcutg Tri Glide Ultra Classic Trike	09>13					3423	-		
1690	Flhtk Ultra Classic Glide	10					3423	3423		
1690	Flhtkl Ultra Limited Low	15					3423	3423		
1690	Flhx Street Glide	11					3423	3423		
1690	Flhxs Street Glide Special	14					3423	3423		
1690	Flhxxx Street Glide Trike	10					3423	-		
1690	Fltrx Road Glide Custom	15					3423	3423		
1690	Fltrxs Road Glide Special	15					3423	3423		
1802	Flhrse Cvo Road King	14					3423	3423		
1802	Flhtkse Cvo Limited	14					3423	3423		
1802	Flhxsecvo Street Glide	10					3423	3423		
1802	Fltruse Cvo Road Glide Ultra	11					3423	3423		
1584	Flstc Heritage Softail Classic	08					3433	3353		
1584	Flstf Fat Boy	08					3433	3353		
1584	Flstfb Fat Boy Special	10					3433	3353		
1584	Flstn Softail Deluxe	08					3433	3353		
1584	Fxcw Rocker	08					3433	3353		
1584	Fxcwc Rocker C	08					3433	3353		
1584	Fxd Dyana Super Glide	08					3433	3353		
1584	Fxdb Dyana Street Bob	08>13					3433	3353		
1584	Fxdc Dyana Super Glide Custom	08					3433	3353		
1584	Fxdf Fat Bob	08					3433	3353		
1584	Fxdl Dyana Low Rider	08					3433	3353		
1584	Fxdwg Dyna Wide Glide	08					3433	3353		
1584	Fxst Softail Standard	08					3433	3353		
1584	Fxstb Night Train	08					3433	3353		
1584	Fxstc Softail Custom	08					3433	3353		
1690	Fld Switchback	12					3433	3353		
1690	Flhrc Road King Classic	11					3433	3353		
1690	Flhtc Electra Glide Classic	11					3433	3353		
1690	Flhtk Ultra Electra Glide	11					3433	3353		
1690	Fls Softail Slim	12					3433	3353		



PASTIGLIE FRENO RMS - SINTER (RICERCA PER MARCA)

RMS - SINTER BRAKE PADS (SEARCH BY BRAND)

CC	MODELLO MODEL	ANNO YEAR								
			 ANTERIORE - FRONT		 POSTERIORE - REAR		 ANTERIORE FRONT	 POSTERIORE REAR		
			PASTIGLIA ORGANICA - ORGANIC				PASTIGLIA SINTERIZZATA SINTERED			
			 OMOLOGATA HOMOLOGATED	 NON OMOLOGATA NOT HOMOLOGATED	 GANASCE BRAKE SHOES	 OMOLOGATA HOMOLOGATED	 NON OMOLOGATA NOT HOMOLOGATED	 GANASCE BRAKE SHOES		
			22 510		22 512	22 510		22512	22 510	22 510
1690	Flstc Heritage Softail Classic	12					3433	3353		
1690	Flstf Fat Boy	12					3433	3353		
1690	Flstf Fat Boy Special	12					3433	3353		
1690	Flstfb Fat Boy	12					3433	3353		
1690	Flstn Softail Deluxe	12					3433	3353		
1690	Fxdb Dyana Street Bob	14					3433	3353		
1690	Fxdba Street Bob	13					3433	3353		
1690	Fxdbb Street Bob	14					3433	3353		
1690	Fxdbp Street Bob	13					3433	3353		
1690	Fxdc Dyana Super Glide Custom	14					3433	3353		
1690	Fxdf Fat Bob	12					3433	3353		
1690	Fxdf Wide Glide	12					3433	3353		
1690	Fxdl Low Rider	14					3433	3353		
1690	Fxs Blackline	13					3433	3353		
1690	Fxs Breakout	14					3433	3353		
1802	Flstnse Cvo Softail Deluxe	14					3433	3353		
1802	Fxsbose Cvo Breakout	13					3433	3353		
HERCULES										
50	Gipsy 50	93>	0190				0193			
80	Lotus 80 Sw	-	0010				0013			
80	Samba Sr 80	93>	2630				2633			
125	Samba Sr 125	93>	2630				2633			
HIGHLAND										
450	Mx 450	06>	0430		1330			1333		
950	V2 950 Motard	00>	0430		1330			1333		
950	V2 950 Outback	99>	0430		1330			1333		
HONDA										
50	Crm 50	88>92	1440							
50	Crm 50	93>	1440		2630			2633		
50	G-Dash 50	89>	1440			0070				
50	Gp 50 Dio	91>	3240	0140		0070				
50	Life Dio	94>		0070		0070				
50	Mb 50	82>	1440							
50	Mbx 50 Sd - Sf	83>	2590				2593			
50	Nh 50 Lead	94>	2630				2633			
50	Nsr 50	93>94	2590				2593			
50	Nsr 50	94>	1070				1073			
50	Nsr 50 (Spagna)	-	2590		2630		2593	2633		

PASTIGLIE FRENO RMS - SINTER (RICERCA PER MARCA)

RMS - SINTER BRAKE PADS (SEARCH BY BRAND)

















CC	MODELLO MODEL	ANNO YEAR	RMS YOUR BEST PARTNER				SINTER	
			ANTERIORE - FRONT		POSTERIORE - REAR		ANTERIORE FRONT	POSTERIORE REAR
			PASTIGLIA ORGANICA - ORGANIC				PASTIGLIA SINTERIZZATA SINTERED	
			OMOLOGATA HOMOLOGATED	NON OMOLOGATA NOT HOMOLOGATED	GANASCE BRAKE SHOES	OMOLOGATA HOMOLOGATED	NON OMOLOGATA NOT HOMOLOGATED	GANASCE BRAKE SHOES
22 510		22 512	22 510		22512	22 510	22 510	
50	Pk Wallaroo - Dx St	90>			0070		0091	
50	Sa Vision	88>93			0070		0091	
50	Sfx 50	95>	0190				0091	0193
50	Sh 50 Fifty	97>	0190					0193
50	Sh City Express	84>			0091		0080	
50	Sh Scoopy	88>94			0080		0080	
50	Sj 50 Bali	93>	0060					0063
50	Sky 50	97>	0190					0193
50	Sky 50 Vetro	00>	0190					0193
50	Sr 50 Dio	90>	3240	0140				
50	Sr 50 Life Dio	94>	3240	0140				
50	Super Dio 50 Sr	91>92	3240	0140				
50	Super Dio 50 Zx	92>	3240	0140				
50	Sxr 50	97>	0190					0193
50	X8r 50 S	98>	0190			9175		0193
50	X8r 50 X	98>	0190			9175		0193
50	Xr 50 Dio Baja	94>	3240	0140			0070	
50	Zx 50 Life Dio	94>	3240	0140			0070	
50	Zx Dio 50	95>	3240	0140				
75	Crn 75	90>				2630		2633
75	Crn 75 R	90>				2630		2633
75	Ns-1 75	92>	0350					0353
75	Nsr 75 Fii	88>	2590					2593
75	Yupy 75	91>	2630					2633
80	Cr 80 R	87>91	2850					2853
80	Cr 80 R	92>	2850			2630		2853
80	Cre 80	98>	2850			2630		2853
80	Crn 80	88>92	1440					
80	Crn 80	93>	1440			2630		2633
80	Lead	86>		1650				
80	Mb 80	80>	0040					
80	Mbx 80	82>	2590					2593
80	Mbx 80 (Espana)	84>	2590					2593
80	Mbx 80 Dx	82>	2590					2593
80	Mbx 80 Fwd	83>	1440					
80	Mbx 80 Volluerkleidung	85>	2590					2593
80	Mcx 80 All Models	82>	0040					
80	Nsr 80 R	87>92	2590			2630		2593
								2633



PASTIGLIE FRENO RMS - SINTER (RICERCA PER MARCA)

RMS - SINTER BRAKE PADS (SEARCH BY BRAND)

CC	MODELLO MODEL	ANNO YEAR								
			 ANTERIORE - FRONT		 POSTERIORE - REAR		 ANTERIORE FRONT	 POSTERIORE REAR		
			PASTIGLIA ORGANICA - ORGANIC				PASTIGLIA SINTERIZZATA SINTERED			
			 OMOLOGATA HOMOLOGATED	 NON OMOLOGATA NOT HOMOLOGATED	 GANASCE BRAKE SHOES	 OMOLOGATA HOMOLOGATED	 NON OMOLOGATA NOT HOMOLOGATED	 GANASCE BRAKE SHOES		
			22 510	22 512	22 510	22512	22 510	22 510		
80	Nsr 80 R	93>	1070		2630		1073	2633		
85	Cr 85	03>07	2850		2630		2853	2633		
90	Srx 90 Shadow	99>	2630				2633			
90	Yupy 90 (Nh 90)	90>	2630				2633			
100	100 Lead	00>	0270				0273			
100	Sh 100	97>	0190				0193			
100	Sj 100 Bali - Ex	98>	0060				0063			
100	Supra 100	99>	1070				1073			
110	Scv 110	08>	0270				0273			
125	Anf 125 Innova	03>11	2820				2823			
125	Ca 125 Rebel	95>97	0580				0583			
125	Ca 125 Rebel	98>	0060				0063			
125	Cb 125 Rs	83>	1440							
125	Cbf 125	09>12	2820				2823			
125	Cbr 125 R	04>07	2820				2823			
125	Cbr 125 R	08>12	2820				2823			
125	Cg 125	04>	1440							
125	Ch 125 Spacy	94>	0270				0273			
125	Clr 125 City Fly	99>	0060				0063			
125	Cr 125	02>	0920		0660		0923	0663		
125	Cr 125	95>01	0920		2630		0923	2633		
125	Cr 125 Rh - J - K - L	87>94			2630			2633		
125	Cr 125 Supermotard	00>	0920		2630		0923	2633		
125	Cre 125	02>	0920		0660		0923	0663		
125	Cre 125	96>01	0920		2630		0923	2633		
125	Crn 125	90>			2630			2633		
125	Crn 125 (Italy)	90>	0060				0063			
125	Crn 125 X Supermotard	07>			0660			0663		
125	Dylan 125	01>	0270			0471	0273			
125	Fes 125 Pantheon	03>	0340		2610		0343	2613		
125	Fes 125 Pantheon	98>02	0970			0410	0973			
125	Fes 125 S-Wing	08>	2540	2550 Con piastra	2560	2570 Con piastra	2543	2563		
125	Fs 125 Sonic	03>	2590				2593			
125	Mbx 125 Rwb	84>	2590				2593			
125	Mtx 125 R	87>	0060				0063			
125	Mtx 125 Rii	89>	0060				0063			
125	Nes 125 @	00>	0270			0471	0273			

PASTIGLIE FRENO RMS - SINTER (RICERCA PER MARCA)

RMS - SINTER BRAKE PADS (SEARCH BY BRAND)

















CC	MODELLO MODEL	ANNO YEAR	RMS YOUR BEST PARTNER				SINTER	
			ANTERIORE - FRONT		POSTERIORE - REAR		ANTERIORE FRONT	POSTERIORE REAR
			PASTIGLIA ORGANICA - ORGANIC				PASTIGLIA SINTERIZZATA SINTERED	
			OMOLOGATA HOMOLOGATED	NON OMOLOGATA NOT HOMOLOGATED	GANASCE BRAKE SHOES	OMOLOGATA HOMOLOGATED	NON OMOLOGATA NOT HOMOLOGATED	GANASCE BRAKE SHOES
22 510		22 512	22 510		22512	22 510	22 510	
125	Nes 125 @	09>	2540	2550 Con piastra	2560	2570 Con piastra	2543	2563
125	Ns 125 F All Models	85>	0060				0063	
125	Nsr 125	88>	0060				0063	
125	Nsr 125 R - F	89>	0060				0063	
125	Nsr 125 Raiden	90>	0060				0063	
125	Nx 125 (Italy)	90>	0060				0063	
125	Pcx 125	10>	2780		0471			
125	Psi 125	02>	0270				0273	
125	Rs 125 R	88>	3170				3173	
125	Rs 125 R	91>94	0870				0873	
125	Rs 125 R	95>			1440		3103	
125	Sh 125	00>09	0270		0471		0273	
125	Sh 125 I	09>	2540	2550 Con piastra	2560	2570 Con piastra	2543	2563
125	Tur/MI 125 (Brasil)	-	3240	0140				
125	Vt 125 C - C2 Shadow	99>	0350				0353	
125	XI 125 L Paris Dakar	89>	0060				0063	
125	XI 125 Paris Dakar	89>	0060				0063	
125	XI 125 R	87>	0060				0063	
125	Xlr 125	93>	0920		2630		0923	2633
125	Xlr 125 R	98>	0920		2630		0923	2633
125	Xlv 125 Varadero	01>	0350				0353	
125	Xr 125 L	03>	0920				0923	
125	Msx	14			3280			3283
150	Cbr R 150	00>03	2820				2823	
150	Cg 150	04>	1440					
150	Crf 150	07>08	2850		0660		2853	0663
150	Fes 150 Pantheon	03>	0340		2610		0343	2613
150	Fes 150 Pantheon	98>02	0970				0410	0973
150	Fes 150 S-Wing	08>	2540	2550 Con piastra	2560	2570 Con piastra	2543	2563
150	Nes 150 @	00>	0270		0471		0273	
150	Nes 150 @	09>	2540	2550 Con piastra	2560	2570 Con piastra	2543	2563
150	Nx 150 (Brasil)	-	0920				0923	
150	Pcx 150	10>	2780		0471			
150	Psi 150	02>	0270				0273	
150	Psi 150	06>	0270		0471		0273	
150	Ses 150 Dylan	01>	0270		0471		0273	



PASTIGLIE FRENO RMS - SINTER (RICERCA PER MARCA)

RMS - SINTER BRAKE PADS (SEARCH BY BRAND)

CC	MODELLO MODEL	ANNO YEAR								
			 ANTERIORE - FRONT		 POSTERIORE - REAR		 ANTERIORE FRONT	 POSTERIORE REAR		
			PASTIGLIA ORGANICA - ORGANIC				PASTIGLIA SINTERIZZATA SINTERED			
			 OMOLOGATA HOMOLOGATED	 NON OMOLOGATA NOT HOMOLOGATED	 GANASCE BRAKE SHOES	 OMOLOGATA HOMOLOGATED	 NON OMOLOGATA NOT HOMOLOGATED	 GANASCE BRAKE SHOES		
			22 510		22 512	22 510		22512	22 510	22 510
150	Sh 150	00>09	0270		0471		0273			
150	Sh 150 I	09>	2540	2550 Con piastra	2560	2570 Con piastra	2543	2563		
200	Ctx 200	04>	0920				0923			
200	Mtx 200 R	87>	0060				0063			
200	Nx 200 (Brasil)	-	0920				0923			
200	Strada 200 (Brasil)	-	3240	0140						
200	XI 200 R	85>	0060				0063			
200	Xlr 200 R	93>	0920		2630			0923 2633		
200	Xr 200 (Brasil)	-	0920				0923			
230	Crf 230 Easy	04>	0920				0923			
230	Crf 230 Easy (Rear Disc)	04>	0920		2630			0923 2633		
250	Cb 250	88>91	3170				3173			
250	Cb 250 Ft Hornet	96>			2610			2613		
250	Cb 250 Night Hawk	91>	0870				0873			
250	Cb 250 Rebel	86>	2590				2593			
250	Cbf 250	04>	0350				0353			
250	Cbr 250 R	11>	0870				0873			
250	Cbr 250 R - Rr	90>			2610			2613		
250	Cbr 250 R Abs	11>	2540	2550 Con piastra			2543			
250	Cbr 250 R Hurricane	86>88			2610			2613		
250	Cmx 250 C Rebel	96>	0580				0583			
250	Cn	95>99	2640				0400			
250	Cn	97>94	2640				0400			
250	Cota 250 4Rt	05>	0640		0650					
250	Cr 250	02>	0920		0660			0923 0663		
250	Cr 250	95>01	0920		2630			0923 2633		
250	Cr 250 R	87>94			2630			2633		
250	Cr 250 Supermotard	00>	0920		2630			0923 2633		
250	Cre 250	02>	0920		0660			0923 0663		
250	Crf 250 F	04>	0920		0660			0923 0663		
250	Crf 250 R	04>09	0920		0660			0923 0663		
250	Crf 250 R Efi	10>	0920		0660			0923 0663		
250	Crf 250 X	04>	0920		0660			0923 0663		
250	Crm 250 R	89>90			2630			2633		
250	Crm 250 R	91>	0920		2630			0923 2633		
250	Crm 250 X Supermotard	07>			0660			0663		
250	Crf L	13					3343			

PASTIGLIE FRENO RMS - SINTER (RICERCA PER MARCA)

RMS - SINTER BRAKE PADS (SEARCH BY BRAND)

















CC	MODELLO MODEL	ANNO YEAR	RMS YOUR BEST PARTNER				SINTER	
			ANTERIORE - FRONT		POSTERIORE - REAR		ANTERIORE FRONT	POSTERIORE REAR
			PASTIGLIA ORGANICA - ORGANIC				PASTIGLIA SINTERIZZATA SINTERED	
			OMOLOGATA HOMOLOGATED	NON OMOLOGATA NOT HOMOLOGATED	GANASCE BRAKE SHOES	OMOLOGATA HOMOLOGATED	NON OMOLOGATA NOT HOMOLOGATED	GANASCE BRAKE SHOES
22 510		22 512	22 510		22512	22 510	22 510	
250	Crn M	14					3343	
250	Fe 250 Foresight	97>98	0970			0410	0973	
250	Fe 250 Foresight	99>	0340		2610		0343 2613	
250	Forza 250	00>04	0970		0930 0470		0973 0933	
250	Forza 250	05>	2540 2550 Con piastra		2560 2570 Con piastra		2543 2563	
250	Freeway	85>	0270			0400		
250	Fusion	85>	0270			0400		
250	Jade 250	91>	0870		2610		0873 2613	
250	Jazz 250	01>04	0970		0930 0470		0973 0933	
250	Jazz 250	05>	2540 2550 Con piastra		2560 2570 Con piastra		2543 2563	
250	Nsr 250 R - Sp	88>93			2610		2613	
250	Nsr 250 R Se-Sp	94>				3103		
250	Nss 250	00>04	0970		0930		0973 0933	
250	Nss 250	05>	2540 2550 Con piastra		2560 2570 Con piastra		2543 2563	
250	Nx 250 Dominator	93>	0920				0923	
250	Ps 250	05>	2540 2550 Con piastra				2543	
250	Reflex 250	00>	0970		0930		0973 0933	
250	Rs 250	93>			1440		3103	
250	Rs 250 R	91>			2610		2613	
250	Rs 250 R	95>			1440			
250	Vt 250 Cr Magna	94>	0870				0873	
250	Vt 250 Spada	88>	0870		2610		0873 2613	
250	Vtr 250	98>	0870		0930		0873 0933	
250	Vtz 250	88>	3170				3173	
250	Vtz 250 Xelvis	92>	0870				0873	
250	Xl 250	90>			2630		2633	
250	Xl 250 Degree	91>	0920				0923	
250	Xlr 250 R	91>	0920		2630		0923 2633	
250	Xlr 250 R Baja	91>	0920		2630		0923 2633	
250	Xr 250 L	91>	0920		2630		0923 2633	
250	Xr 250 R	88>93			2630		2633	
250	Xr 250 R	94>	0920		2630		0923 2633	
250	Crf L	14			3280		3283	
250	Cbr R Abs (Nissin)	11-13					3323	
260	Cre 260	90>			2630		2633	
300	Cb 300	10>	0350				0353	



PASTIGLIE FRENO RMS - SINTER (RICERCA PER MARCA)

RMS - SINTER BRAKE PADS (SEARCH BY BRAND)

CC	MODELLO MODEL	ANNO YEAR								
			 ANTERIORE - FRONT		 POSTERIORE - REAR		 ANTERIORE FRONT	 POSTERIORE REAR		
			PASTIGLIA ORGANICA - ORGANIC				PASTIGLIA SINTERIZZATA SINTERED			
			 OMOLOGATA HOMOLOGATED	 NON OMOLOGATA NOT HOMOLOGATED	 GANASCE BRAKE SHOES	 OMOLOGATA HOMOLOGATED	 NON OMOLOGATA NOT HOMOLOGATED	 GANASCE BRAKE SHOES		
			22 510	2550	22 512	22 510	22512	22 510	22 510	
300	Sh 300 i	07>	2540	2550 Con piastra	2560	2570 Con piastra	2543	2563		
300	Sh 300 i Abs	07>	2540	2550 Con piastra	2560	2570 Con piastra	2543	2563		
300	Cbr F	14						3323		
350	Nx 350 Sahara (Brasil)	-	0920				0923			
400	Cb 400 Fk (Cb-1)	90>	0870		2610		0873	2613		
400	Cb 400 Super Four	92>	0870		2610		0873	2613		
400	Cb 400 Super Four (Sf)	99>					2913	3113		
400	Cb-1400 F	89>	0870		2610		0873	2613		
400	Cbr 400 R R	88>93	0870		2610		0873	2613		
400	Fjs 400 Silver Wing	06>	0340		2640	0890	0343	2643		
400	Fjs 400 Silver Wing (Freno A Mano)	06>	1440							
400	Ntv 400 Bros	88>			2610			2613		
400	Rvf 400	94>					3103			
400	Sw-T 400	09>	2540	2550 Con piastra	2640	0890	2543	2643		
400	Sw-T 400 Abs	09>	2540	2550 Con piastra	2640	0890	2543	2643		
400	Transalp 400	92>	3170				3173			
400	Transalp 400	92>			2610			2613		
400	Vfr 400 R	87>89			2610			2613		
400	Vfr 400 R (Nc 30)	91>					3103			
400	Xr 400	96>	0920		2630		0923	2633		
400	Xr 400 Supermotard	00>	0920		2630		0923	2633		
440	Xr 440 R (Dall'ara)	99>	0920		2630		0923	2633		
450	Cre 450	02>	0920		0660		0923	0663		
450	Crf 450 Efi	09>	0920		0660		0923	0663		
450	Crf 450 R - E	02>	0920		0660		0923	0663		
450	Crf 450 X	05>	0920		0660		0923	0663		
450	Crm 450 X Supermotard	07>			0660			0663		
490	Cre 490 X ie	09>	0920		0660		0923	0663		
490	Crf 490 R ie	09>	0920		0660		0923	0663		
500	Cb 500 R/T	94>	0870				0873			
500	Cb 500 S	99>	1010		1330		1013	1333		
500	Cb 500 V	97>	1010		1330		1013	1333		
500	Cbf 500	04>	0870		0930		0873	0933		
500	Cbf 500 Abs	04>	2540	2550 Con piastra	0930		2543	0933		
500	Cr 500 R	87>93			2630			2633		
500	Cr 500 R	96>01	0920		2630		0923	2633		

PASTIGLIE FRENO RMS - SINTER (RICERCA PER MARCA)

RMS - SINTER BRAKE PADS (SEARCH BY BRAND)

















CC	MODELLO MODEL	ANNO YEAR	RMS YOUR BEST PARTNER				SINTER			
			ANTERIORE - FRONT		POSTERIORE - REAR		ANTERIORE FRONT	POSTERIORE REAR		
			PASTIGLIA ORGANICA - ORGANIC				PASTIGLIA SINTERIZZATA SINTERED			
			OMOLOGATA HOMOLOGATED	NON OMOLOGATA NOT HOMOLOGATED	GANASCE BRAKE SHOES	OMOLOGATA HOMOLOGATED	NON OMOLOGATA NOT HOMOLOGATED	GANASCE BRAKE SHOES		
22 510		22 512	22 510		22512	22 510	22 510			
500	Crn 500 X Supermotard	07>			0660	0663				
500	Nx 500 Dominator	88>96			2610	2613				
500	Nx 500 Dominator	97>	1010			1330	1013 1333			
500	Cb F	13					3323			
500	Cb X	13					3323			
500	Cbr R	14					3323			
600	Cb 600 F Hornet	07>	0870			0873 2933				
600	Cb 600 F Hornet	98>06	0870			0930	0873 0933			
600	Cb 600 F Hornet (Japan)	98>			0930	2913	0933			
600	Cb 600 F Hornet Abs	07>	2540	2550 Con piastra	0930	2543 0933				
600	Cb 600 F Hornet S	04>	0870			0930	0873 0933			
600	Cbf 600	04>07	0870			0930	0873 0933			
600	Cbf 600 N	08>	2540	2550 Con piastra	0930	2543 0933				
600	Cbf 600 S	08>	2540	2550 Con piastra	0930	2543 0933				
600	Cbr 600 F	11>	0870			0873 2933				
600	Cbr 600 F	95>98	0870			0930	0873 0933			
600	Cbr 600 F	99>			0930	2913	0933			
600	Cbr 600 F - Super Sport	91>94			0930	0933				
600	Cbr 600 F Abs	11>	2540	2550 Con piastra			2543 2933			
600	Cbr 600 F4 Sport	01>			0930	2913	0933			
600	Cbr 600 Rr	03>04			0930	2913	0933			
600	Cbr 600 Rr	05>06			0930	2953	0933			
600	Cbr 600 Rr	07>					2953 2933			
600	Cbr 600 Rr Abs	09>					2953 2933			
600	Fjs 600 Silver Wing	01>	0340			2640 0890	0343 2643			
600	Fjs 600 Silver Wing (Freno A Mano)	01>	1440							
600	Fsc 600 Silver Wing	01>	0340			2640 0890	0343 2643			
600	Ntv 600 Bross	88>			2610	2613				
600	Ntv 600 Revere	88>			2610	2613				
600	Sw-T 600 Silver Wing	11>	2540	2550 Con piastra	2640 0890	2543 2643				
600	Vt 600 C-Cd Shadow Vlx	94>	0870			0873				
600	XI 600 VTransalp	91>93			2610	2613				
600	XI 600 VTransalp	94>96	0870			2610	0873 2613			
600	XI 600 VTransalp	97>	0920			2610	0923 2613			
600	Xr 600 L - R	93>	0920			2630	0923 2633			



PASTIGLIE FRENO RMS - SINTER (RICERCA PER MARCA)

RMS - SINTER BRAKE PADS (SEARCH BY BRAND)

CC	MODELLO MODEL	ANNO YEAR								
			 ANTERIORE - FRONT		 POSTERIORE - REAR		 ANTERIORE FRONT	 POSTERIORE REAR		
			PASTIGLIA ORGANICA - ORGANIC				PASTIGLIA SINTERIZZATA SINTERED			
			 OMOLOGATA HOMOLOGATED	 NON OMOLOGATA NOT HOMOLOGATED	 GANASCE BRAKE SHOES	 OMOLOGATA HOMOLOGATED	 NON OMOLOGATA NOT HOMOLOGATED	 GANASCE BRAKE SHOES		
			22 510		22 512	22 510		22512	22 510	22 510
600	Xr 600 R	91>	2630				2633			
650	Fmx 650	05>	0870		0870		0873 0873			
650	Nt 650 Hawk Gt	88>90	0870		2610		0873 2613			
650	Nt 650 V Deauville	02>05	0970		0340		0973 0343			
650	Nt 650 V Deauville	98>01	1010		2610		1013 2613			
650	Ntv 650 Bros	88>92			2610		2613			
650	Ntv 650 Deauville	98>01	1010		2610		1013 2613			
650	Ntv 650 Revere	93>97	0870		2610		0873 2613			
650	Ntv 650 V 2 Deauville	02>	0970		2610		0973 2613			
650	Nx 650 Dominator	93>94	3170				3173			
650	Nx 650 Dominator	88>96			2610		2613			
650	Nx 650 Dominator	93>94			2610		2613			
650	Nx 650 Dominator	97>	1010		1330		1013 1333			
650	Slr 650	97>	1010		1330		1013 1333			
650	Sx 650 Vigor	99>02	1010		1330		1013 1333			
650	Xl 650 V Transalp	99>	0920		2610		0923 2613			
650	Xr 650 L	93>95			2630		2633			
650	Xr 650 L	96>	0920		2630		0923 2633			
650	Xr 650 R	99>	0920		2630		0923 2633			
650	Xrv 650 Africa Twin	88>			2610		2613			
650	Cb F	14					3323			
650	Cbr F	14					3323			
670	Integra	12>	2540	2550 Con piastra			2543 2933			
680	Dn-01 680	08>	2540	2550 Con piastra	2640	0890	2543 2643			
700	Nt 700 Deauville Abs	06>	2540	2550 Con piastra	0970		2543 0973			
700	Nt 700 V Varadero - Abs	10>	2540	2550 Con piastra	0970		2543 0973			
700	Vfr 700 F/F2 Interceptor	86>87	3170				3173			
700	Vfr 700 F Interceptor	88>	0870		0870		0873 0873			
700	Xl 700 Transalp	08>	0920		2610		0923 2613			
700	Xl 700 Transalp Abs	08>	2540	2550 Con piastra	0930		2543 0933			
700	Ctx D Abs	14					3323			
700	Ctx N	14					3323			
700	Ctx Nd Abs	14					3323			
750	Cb 750 N Seven Fifty	92>	0870		0930		0873 0933			
750	Cbr 750 F	88>	0870		0870		0873 0873			

PASTIGLIE FRENO RMS - SINTER (RICERCA PER MARCA)

RMS - SINTER BRAKE PADS (SEARCH BY BRAND)

















CC	MODELLO MODEL	ANNO YEAR	RMS YOUR BEST PARTNER				SINTER			
			ANTERIORE - FRONT		POSTERIORE - REAR		ANTERIORE FRONT	POSTERIORE REAR		
			PASTIGLIA ORGANICA - ORGANIC				PASTIGLIA SINTERIZZATA SINTERED			
			OMOLOGATA HOMOLOGATED	NON OMOLOGATA NOT HOMOLOGATED	GANASCE BRAKE SHOES	OMOLOGATA HOMOLOGATED	NON OMOLOGATA NOT HOMOLOGATED	GANASCE BRAKE SHOES		
22 510		22 512	22 510		22512	22 510	22 510			
750	Cbr 750 Super Aero	88>						3103		
750	Magna 750	93>	0870				0873			
750	Rvf 750 Rr (Rc 45)	94>						3103		
750	Vf 750 C	93>	0870				0873			
750	Vfr 750 F	90>	0870		2640	0890	0873	2643		
750	Vfr 750 F Interceptor	88>89	2640	0890	2640	0890	2643	2643		
750	Vt 750 Black Window	01>	2640	0890			2643			
750	Vt 750 C Shadow	97>03	2640	0890			2643			
750	Vt 750 C2 Shadow A.c.e.	97>03	2640	0890			2643			
750	Vt 750 C2b	11>	0870				0873			
750	Vt 750 C4 Shadow	04>	2640	0890			2643			
750	Vt 750 Rs	11>	0870				0873			
750	Vt 750 S	11>	0870				0873			
750	Vt 750 Shadow Spirit	07>	0870				0873			
750	Xrv 750 R Africa Twin	90>93			2610			2613		
750	Xrv 750 R Africa Twin	94>	0920		2610			0923	2613	
800	800 Crossrunner	11>	2540	2550 Con piastra	3050			2543	3053	
800	Pc 800 Pacific Coast	88>	0870				0873			
800	Vfr 800	06>	2540	2550 Con piastra	0970			2543	0973	
800	Vfr 800 Abs	06>	2540	2550 Con piastra	0970			2543	0973	
800	Vfr 800 Fi	98>01	0970		0340			0973	0343	
800	Vfr 800 V-Tech	02>05	0970		0340			0973	0343	
800	Vfr 800 V-Tech Abs	02>05	0970		0340			0973	0343	
900	Cb 900 Hornet	01>			0930			0933		
900	Cbr 900 Rr Fireblade	94>97			0930			0933		
900	Cbr 900 Rr-Fireblade	92>93			0930			0933		
900	Cbr 900 Rr-Fireblade	98>			0930			2913	0933	
900	Cbr 900 Rr-Fireblade (954 Cc)	02>03			0930			2913	0933	
950	Vfr 950 F Carat	92>	0870		2640	0890			0873	2643
1000	Cb 1000 R	08>			3050			2953	3053	
1000	Cb 1000 R Abs	08>	2540	2550 Con piastra	3050			2543	3053	
1000	Cb 1000 Sf	93>			0930			3103	0933	
1000	Cb 1000 Superfour (Big Four)	92>	0870		2640	0890			0873	2643
1000	Cbf 1000	06>	2640	0890	0930			2643	0933	
1000	Cbf 1000 Abs	06>	2540	2550 Con piastra	2560	2570 Con piastra			2543	2543
1000	Cbf 1000 Limited Edition	09>	2640	0890	0930			2643	0933	



PASTIGLIE FRENO RMS - SINTER (RICERCA PER MARCA)

RMS - SINTER BRAKE PADS (SEARCH BY BRAND)

CC	MODELLO MODEL	ANNO YEAR								
			 ANTERIORE - FRONT		 POSTERIORE - REAR		 ANTERIORE FRONT	 POSTERIORE REAR		
			PASTIGLIA ORGANICA - ORGANIC				PASTIGLIA SINTERIZZATA SINTERED			
			 OMOLOGATA HOMOLOGATED	 NON OMOLOGATA NOT HOMOLOGATED	 GANASCE BRAKE SHOES	 OMOLOGATA HOMOLOGATED	 NON OMOLOGATA NOT HOMOLOGATED	 GANASCE BRAKE SHOES		
			22 510		22 512	22 510		22512	22 510	22 510
1000	Cbf 1000 Limited Edition Abs	09>	2540	2550 Con piastra	2560	2570 Con piastra	2543	2543		
1000	Cbr 1000 Big One	93>			0930			0933		
1000	Cbr 1000 F	89>92	0870		0870		0873	0873		
1000	Cbr 1000 Rr	04>05			0930		2953	0933		
1000	Cbr 1000 Rr	06>08					2953	2933		
1000	Cbr 1000 Rr Abs	09>					2953	2933		
1000	Vtr 1000 Fv Firestorm	97>99			0930			0933		
1000	Vtr 1000 Sp-1 Sp-2	00>			0930		2913	0933		
1000	Xl 1000 V Varadero	99>03	0970		0970		0973	0973		
1000	Xlv 1000 Varadero	04>	2540	2550 Con piastra	0340		2543	0343		
1000	Xlv 1000 Varadero Travel Abs	04>	2540	2550 Con piastra	0340		2543	0343		
1000	Cbr Rr	13					3333			
1100	1100 American Classic Edition	95>	0870		0930		0873	0933		
1100	Cb 1100 Hornet	99>	0970		0340		0973	0343		
1100	Cb 1100 Sf X Eleven (X11)	00>	0970		0340		0973	0343		
1100	Cbr 1100 Xx Blackbird	97>98	0970		0340		0973	0343		
1100	Cbr 1100 Xx Superblackbird	99>	0970		0340		0973	0343		
1100	St 1100 Abs-Tcs	92>	0870		0870		0873	0873		
1100	St 1100 Pan European	89>96	0870		0870		0873	0873		
1100	St 1100 Pan European	97>	0970		0340		0973	0343		
1100	Vt 1100 C Shadow	94>96	0870				0873			
1100	Vt 1100 C2 Shadow	95>	0870		0930		0873	0933		
1100	Vt 1100 C2 Y	00>	0870		0930		0873	0933		
1200	Gl Dx (Tutti I Modelli)		0330		0330					
1200	Vfr 1200 F	10>			3050			3053		
1300	Cb 1300	98>00						3113		
1300	Cb 1300 R	01>					2913	3113		
1300	Cb 1300 X4	97>						3113		
1300	Stx 1300 Pan European Abs	02>	0970		0340		0973	0343		
1300	Vt 1300 Fury	10>	0870		0930		0873	0933		
1300	Vt 1300 Fury Abs	10>	2540	2550 Con piastra	0970		2543	0973		
1300	Vtx 1300 C	04>	0870		0930		0873	0933		
1300	Vtx 1300 S	03>	0870		0930		0873	0933		
1500	Gl 1500 F6c Valkyrie	97>	0870		2640	0890	0873	2643		
1800	Gl 1800 Gold Wing	01>	0970		0340		0973	0343		
1800	Vtx 1800	01>	0970		0340		0973	0343		

PASTIGLIE FRENO RMS - SINTER (RICERCA PER MARCA)

RMS - SINTER BRAKE PADS (SEARCH BY BRAND)

















CC	MODELLO MODEL	ANNO YEAR	RMS YOUR BEST PARTNER				SINTER	
			ANTERIORE - FRONT		POSTERIORE - REAR		ANTERIORE FRONT	POSTERIORE REAR
			PASTIGLIA ORGANICA - ORGANIC				PASTIGLIA SINTERIZZATA SINTERED	
			OMOLOGATA HOMOLOGATED	NON OMOLOGATA NOT HOMOLOGATED	GANASCE BRAKE SHOES	OMOLOGATA HOMOLOGATED	NON OMOLOGATA NOT HOMOLOGATED	GANASCE BRAKE SHOES
22 510		22 512	22 510		22512	22 510	22 510	
HONDA - HM								
50	Cre 50	06>	0360		2630		0363	2633
50	Cre 50 (Da Telaio Nr.1001 A 2818)	-			0010			0013
50	Cre 50 (Da Telaio Nr.2819)	-	0360				0363	
50	Cre 50 All Models	03>04	0360		2810		0363	
50	Cre 50 Baja - Derapage	01>02	0360		0080		0363	0083
50	Cre 50 Six	95>02	0360		0080		0363	0083
125	Cre 125	02>	0920		0660		0923	0663
125	Cre 125	>01	0920		2630		0923	2633
125	Cre 125 Supermotard	04>06	0920		0660		0923	0663
125	Cre 125 Supermotard	>03	0920		2630		0923	2633
125	Crn F 125 X Super Motard	07>			0660			0663
250	Cre 250 F	04>	0920		0660		0923	0663
250	Cre 250 Supermotard	04>	0920		0660		0923	0663
250	Cre 250 Supermotard	>03	0920		2630		0923	2633
250	Cre 250 X	04>	0920		0660		0923	0663
250	Crf 250 Supermotard	04>	0920		0660		0923	0663
250	Crn F 250 X ie Super Motard	07>			0660			0663
290	Crn F 290 X ie Super Motard	07>			0660			0663
450	Cre 450 F	02>	0920		0660		0923	0663
450	Cre 450 X	04>	0920		0660		0923	0663
450	Crn F 450 X ie Super Motard	07>			0660			0663
490	Crn F 490 X ie Super Motard	07>			0660			0663
HONDA ATV								
200	Atc 200 X	83>85	2850				2853	
200	Atc 200 X	86>87	2850		2850		2853	2853
250	Atc 250 R	81>	1440					
250	Atc 250 R	82>	1440		2850			2853
250	Atc 250 R	83>84	2850		2850		2853	2853
250	Trx 250 Ex Sportrax	01>	2850				2853	
250	Trx 250 X Fourtrax	87>92	2850		2850		2853	2853
300	Trx 300 Ex Fourtrax	93>00	2850		2850		2853	2853
350	Atc 350 X	85>			2850			2853
350	Atc 350 X	86>			2850			2853
400	Trx 400 Ex Foutrax	99>00	2850		2850		2853	2853
400	Trx 400 Ex Sportrax	01>	2850		2850		2853	2853
400	Trx 400 R	04>	0920				0923	



PASTIGLIE FRENO RMS - SINTER (RICERCA PER MARCA)

RMS - SINTER BRAKE PADS (SEARCH BY BRAND)

CC	MODELLO MODEL	ANNO YEAR								
			 ANTERIORE - FRONT		 POSTERIORE - REAR		 ANTERIORE FRONT	 POSTERIORE REAR		
			PASTIGLIA ORGANICA - ORGANIC				PASTIGLIA SINTERIZZATA SINTERED			
			 OMOLOGATA HOMOLOGATED	 NON OMOLOGATA NOT HOMOLOGATED	 GANASCE BRAKE SHOES	 OMOLOGATA HOMOLOGATED	 NON OMOLOGATA NOT HOMOLOGATED	 GANASCE BRAKE SHOES		
			22 510	22 512	22 510	22512	22 510	22 510		
HONDA ITALIA										
125	Dt 125	87>	0060		0063					
125	Mtx 125 R	86>	0060		0063					
125	Mtx 125 Rally Sport	88>	0060		0063					
125	Ns 125 F	85>	0060		0063					
125	Ns 125 R Super Sport	87>	0060		0063					
125	Nsr 125 R	89>	0060		0063					
125	XI 125 L Paris Dakar	85>	0060		0063					
125	XI 125 R2	87>	0060		0063					
200	XI 200 L	85>	0060		0063					
200	XI 200 L Paris Dakar	87>	0060		0063					
200	XI 200 R2	87>	0060		0063					
HOREX										
80	Rebell 80 T	86>	3150		3150	3153	3153			
80	Sport 80 L	86>	3150		3150	3153	3153			
125	Imperator 125	96>	3150			3153				
125	Regent 125	96>	3150			3153				
560	E 560	86>	3150		3150	3153	3153			
600	Columbus 600	87>	3150		3150	3153	3153			
HRD										
50	Gs 50 Enduro	00>02	0740		1330		1333			
50	Sonic 2 50 Supermotard	00>02	0740		0080		0083			
50	Sonic 2 50 Trail	00>02	0740		0080		0083			
125	Platino 125 St	86>	0010			0013				
125	Road 125 St	86>	0010			0013				
125	Supermotard 125	00>02	0740		0080		0083			
125	Trail 125	00>02	0740		0080		0083			
HSC										
50	Hsc 01 50	92>	3240	0140						
50	Sr 50 Dio	92>	3240	0140						
50	Zr 50	92>	3240	0140						
50	Zx 50 Dio	92>	3240	0140						
HUSABERG										
250	Te 250	11>	0430		0750		0753			
300	Te 300	11>	0430		0750		0753			
350	Fc 350	95>	0430		1330		1333			
350	Fe 350	95>	0430		1330		1333			
350	Mc 350	91>93			1200					
350	Mc 350	94>			1330		1333			

PASTIGLIE FRENO RMS - SINTER (RICERCA PER MARCA)

RMS - SINTER BRAKE PADS (SEARCH BY BRAND)

















CC	MODELLO MODEL	ANNO YEAR	RMS YOUR BEST PARTNER				SINTER	
			ANTERIORE - FRONT		POSTERIORE - REAR		ANTERIORE FRONT	POSTERIORE REAR
			PASTIGLIA ORGANICA - ORGANIC				PASTIGLIA SINTERIZZATA SINTERED	
			OMOLOGATA HOMOLOGATED	NON OMOLOGATA NOT HOMOLOGATED	GANASCE BRAKE SHOES	OMOLOGATA HOMOLOGATED	NON OMOLOGATA NOT HOMOLOGATED	GANASCE BRAKE SHOES
22 510		22 512	22 510		22512	22 510	22 510	
390	Fe 390	11>	0430		0750		0753	
400	Fc 400	99>02	0430		1330		1333	
400	Fe 400 S - E	98>03	0430		1330		1333	
400	Fs 400 E - C	01>03	1150		1330	1153	1333	
450	Fc 450	98>03	0430		1330		1333	
450	Fe 450	09>	0430		0750		0753	
450	Fe 450 E	04>	0430		1330		1333	
450	Fs 450 C	06>			1330		1333	
450	Fs 450 E - C	03>05	1150		1330	1153	1333	
450	Fx 450	03>	0430		1330		1333	
470	Fc 470 E	01>02	0430		1330		1333	
470	Fx 470 E	01>02	0430		1330		1333	
500	500 All Models	91>			1200			
501	501 Enduro	-			1200			
501	Fc 501	98>01	0430		1330		1333	
501	Fe 501 S - E	98>04	0430		1330		1333	
550	Fc 550	01>	0430		1330		1333	
550	Fe 550 E	04>	0430		1330		1333	
570	Fe 570	09>	0430		0750		0753	
600	600 Enduro	-			1200			
600	Ef 600 E (Quad)	98>	1330			1333		
600	Fc 600 Supermotard	98>01	0430		1330		1333	
600	Fe 600 S - E - R	98>02	0430		1330		1333	
650	Fe 650 E	01>	0430		1330		1333	
650	Fs 650 E - C	01>05	1150		1330	1153	1333	
650	Fs 650 E - C	06>			1330		1333	
650	Fx 650 E	01>	0430		1330		1333	
HUSQVARNA								
50	Cr 50 Junior	06>	0650					
50	Cr 50 Pro Senjor	06>	0650		3220	3223		
50	Cr 50 Senjor	06>	0650		3220	3223		
50	Husqy Boy 50	01>	0080			0083		
50	Racing 50	98>	0080			0083		
50	Sm 50	02>	0740		0080		0083	
50	Sm 50	10>	0650		3220		3223	
50	Wr 50	02>	0740		0080		0083	
50	Wrs 50 (Scooter)	98>	0080			0083		
125	125 All Models 1992	92>	1420		1440		1423	



PASTIGLIE FRENO RMS - SINTER (RICERCA PER MARCA)















RMS - SINTER BRAKE PADS (SEARCH BY BRAND)

CC	MODELLO MODEL	ANNO YEAR								
			 ANTERIORE - FRONT		 POSTERIORE - REAR		 ANTERIORE FRONT	 POSTERIORE REAR		
			PASTIGLIA ORGANICA - ORGANIC				PASTIGLIA SINTERIZZATA SINTERED			
			 OMOLOGATA HOMOLOGATED	 NON OMOLOGATA NOT HOMOLOGATED	 GANASCE BRAKE SHOES	 OMOLOGATA HOMOLOGATED	 NON OMOLOGATA NOT HOMOLOGATED	 GANASCE BRAKE SHOES		
			22 510		22 512	22 510		22512	22 510	22 510
125	125 All Models 1993	93>	1420				1423			
125	125 All Models 1994-1995	94>95	0430		1330			1333		
125	Cr 125	85>95	0010				0013			
125	Cr 125	96>03	0430		1330			1333		
125	Cr 125	04>	0430		0750			0753		
125	Cr 125 Cross	91>95			1200					
125	Sm 125 Supermotard	98>	0430		1330			1333		
125	Wr 125	86>	0010				0013			
125	Wr 125	91>97			1200					
125	Wr 125	98>03	0430		1330			1333		
125	Wr 125	04>	0430		0750			0753		
125	Wre 125	04>	0430		0750			0753		
125	Wre 125 Dual	95>03	0430		1330			1333		
240	Wr 240	86>	0010				0013			
240	Wr 240	91>			1200					
250	250 All Models 1992	92>	1420		1440		1423			
250	250 All Models 1993	93>	1420				1423			
250	250 All Models 1994-1995	94>95	0430		1330			1333		
250	Cr 250	85>95	0010				0013			
250	Cr 250	96>03	0430		1330			1333		
250	Cr 250	04>	0430		0750			0753		
250	Cr 250 Cross	91>			1200					
250	Tc 250	02>03	0430		1330			1333		
250	Tc 250	04>	0430		0750			0753		
250	Te 250	02>03	0430		1330			1333		
250	Te 250	04>	0430		0750			0753		
250	Te 250 4T	10>	0430		0750			0753		
250	Wr 250	90>			1200					
250	Wr 250	91>97			1200					
250	Wr 250	04>	0430		0750			0753		
250	Wr 250 Enduro	98>03	0430		1330			1333		
260	Wr 260	91>			1200					
300	Wr 300	10>	0430		0750			0753		
310	Te 310 4T	10>	0430		0750			0753		
350	Te 350	90>95			1200					
350	Te 350	96>	0430		1330			1333		
360	Wr 360 Enduro	98>	0430		1330			1333		
400	Sm 400 Supermotard	02>	0520		1330		0523	1333		

PASTIGLIE FRENO RMS - SINTER (RICERCA PER MARCA)

RMS - SINTER BRAKE PADS (SEARCH BY BRAND)

















CC	MODELLO MODEL	ANNO YEAR								
			 ANTERIORE - FRONT		 POSTERIORE - REAR		 ANTERIORE FRONT	 POSTERIORE REAR		
			PASTIGLIA ORGANICA - ORGANIC				PASTIGLIA SINTERIZZATA SINTERED			
			 OMOLOGATA HOMOLOGATED	 NON OMOLOGATA NOT HOMOLOGATED	 GANASCE BRAKE SHOES	 OMOLOGATA HOMOLOGATED	 NON OMOLOGATA NOT HOMOLOGATED	 GANASCE BRAKE SHOES		
			22 510		22 512	22 510		22512	22 510	22 510
400	Tc 400	02>	0430			1330		1333		
400	Te 400	01>	0430			1330		1333		
400	Te 400 E Dual - Enduro	98>	0430			1330		1333		
400	Wr 400	86>	0010				0013			
410	Te 410 E	00>	0430			1330		1333		
449	Smr 449	11>	2860			0750	2863	0753		
449	Tc 449	11>	0430			0750		0753		
449	Te 449	11>	0430			0750		0753		
450	Sm 450 R	03>04	0520			1330	0523	1333		
450	Sm 450 R	05>	2860			1330	2863	1333		
450	Tc 450	04>	0430			0750		0753		
450	Te 450	04>	0430			0750		0753		
500	Cr 500	85>	0010				0013			
510	Sm 510 R	05>	2860			1330	2863	1333		
510	Tc 510	04>	0430			0750		0753		
510	Te 510	90>				1200				
510	Te 510	04>	0430			0750		0753		
510	Te 510 C	04>	0430			0750		0753		
511	Smr 511	11>	2860			0750	2863	0753		
511	Te 511	11>	0430			0750		0753		
570	Nox 570	98>	1100			0430	1103			
570	R 570	01>	0520			1330	0523	1333		
570	Tc 570	01>	0430			1330		1333		
570	Te 570	01>03	0430			1330		1333		
570	Te 570	04>	0430			0750		0753		
600	Lt 600 Dual	98>	1100			0430	1103			
600	Sm 600 Supermotard	98>	1100			1330	1103	1333		
600	Te 600	96>	0430			1330		1333		
600	Te 600 E Dual - Enduro	98>	0430			1330		1333		
610	Lt 610	00>	1100			1330	1103	1333		
610	Sm 610	00>	1100			1330	1103	1333		
610	Sm 610 ie	07>	2860			0750	2863	0753		
610	Tc 610	96>	0430			1330		1333		
610	Tc 610 Cross	91>	1420			1440	1423			
610	Te 610	91>97	1420			1440	1423			
610	Te 610 E	99>03	0430			1330		1333		
610	Te 610 E	04>	0430			0750		0753		
610	Te 610 E Supermotard	00>	1100			1330	1103	1333		



PASTIGLIE FRENO RMS - SINTER (RICERCA PER MARCA)











RMS - SINTER BRAKE PADS (SEARCH BY BRAND)

CC	MODELLO MODEL	ANNO YEAR								
			 ANTERIORE - FRONT		 POSTERIORE - REAR		 ANTERIORE FRONT	 POSTERIORE REAR		
			PASTIGLIA ORGANICA - ORGANIC				PASTIGLIA SINTERIZZATA SINTERED			
			 OMOLOGATA HOMOLOGATED	 NON OMOLOGATA NOT HOMOLOGATED	 GANASCE BRAKE SHOES	 OMOLOGATA HOMOLOGATED	 NON OMOLOGATA NOT HOMOLOGATED	 GANASCE BRAKE SHOES		
			22 510	22 512	22 510	22512	22 510	22 510		
630	Sm 630	10>	2860		0750			2863	0753	
630	Sm 630	>09	1100		1330			1103	1333	
630	Te 630	10>	0430		0750				0753	
650	Str 650 Crc	07>	2860		0750			2863	0753	
HYOSUNG										
50	Avanti 50	99>	2800							
50	Ga-4 50	99>	1490					1493		
50	Rush 50	97>	2800							
50	Sb 50	00>	2800							
50	Sd 50	00>	2800							
50	Sense 50	98>	2800							
50	Sf 50	99>	2800							
50	Super Cab 50	95>97	2800							
50	Super Cab 50 Plus	98>	2800							
100	Cab 100	98>	2800							
100	Ez 100	00>	2800							
110	Fx 110	02>	0040							
110	Kr 110 Master	04>	0040							
110	Midas 110 Plus	98>	2800							
125	Aquila 125	00>	1420					1423		
125	Boomer 125	03>	0190					0193		
125	Comet 125	02>	2590					2593		
125	Exceed 125	02>	0190					0193		
125	Grand Prix 125	98>	0190		2590			0193	2593	
125	Grand Prix 125 Plus	02>	2590					2593		
125	Gt 125 Comet	02>03	2590					2593		
125	Gv 125 Aguila	02>04	2590					2593		
125	Hyper 125	99>	0190					0193		
125	Rt 125 Karion	02>06	2590					2593		
125	Rx 125	00>	0740							
125	V2 125	99>	0870					0873		
125	Xrx 125 Offroad	99>06	2590					2593		
150	Exceed 150	02>	0190		2590			0193	2593	
150	Grand Prix 150	98>	0190		2590			0193	2593	
250	Aquila 250	00>	0870					0873		
250	Comet 250	02>	0190					0193		
250	Gv 250	02>	2590					2593		
252	Aquila 252	00>	0870					0873		

PASTIGLIE FRENO RMS - SINTER (RICERCA PER MARCA)

RMS - SINTER BRAKE PADS (SEARCH BY BRAND)

















CC	MODELLO MODEL	ANNO YEAR	RMS YOUR BEST PARTNER				SINTER	
			 ANTERIORE - FRONT		 POSTERIORE - REAR		 ANTERIORE FRONT	 POSTERIORE REAR
			PASTIGLIA ORGANICA - ORGANIC				PASTIGLIA SINTERIZZATA SINTERED	
								
			OMOLOGATA HOMOLOGATED	NON OMOLOGATA NOT HOMOLOGATED	GANASCE BRAKE SHOES	OMOLOGATA HOMOLOGATED	NON OMOLOGATA NOT HOMOLOGATED	GANASCE BRAKE SHOES
22 510		22 512	22 510		22512	22 510	22 510	
300	Ga 300	98>	1490				1493	
400	Te 400 (Atv)	05>	1440					
400	Xrx 400	05>	2590		2630		2593	2633
450	Rx 450 Sm	08>	2860		1330		2863	1333
450	Te 450 (Atv)	07>	1440					
600	Comet 600	02>			0720		0723	
600	Comet 600	03>	2590				2593	
650	Gv 650 Aguila	04>05	2590		3130		2593	3133
INNOCENTI								
125	Lambretta 125 Li	-			0601		0601	
150	Lambretta 150 Li	-			0601		0601	
175	Lambretta 175 Li	-			0601		0601	
175	Lambretta 175 TV i	-					0601	
ITALJET								
50	Adly 50	90>					0061	
50	Bazooka 2 50	92>	0180					
50	Cruise 50	95>	0180					
50	Dragster 50	98>	0080		0080		0083	0083
50	Formula 50	94>96	0160		0190		0193	
50	Formula 50	97>	0080		0080		0083	0083
50	Jet Set 50	02>	2810					
50	Pista 2 50	92>	0180					
50	Rg 50	98>	0080				0083	
50	Scoop 50	93>	0180					
50	Shopping 50	90>			0201		0230	
50	Torpedo 50	97>	0080				0130	0083
50	Yankee 8 50	94>	0180					
80	Formula 80	94>	0160		0190		0193	
125	Dragster 125	99>	0080				0083	
125	Formula 125	94>96	0160		0190		0193	
125	Formula 125	97>	0080		0080		0083	0083
125	Jet Set 125	02>	2810					
125	Jupiter 125	02>	0410		2810		0413	
125	Millenium 125	>00	2730					
125	Millenium 125 (Seconda Serie)	01>	2810		0560			
125	Torpedo 125	99>	0080				0083	
125	Twin 125	98>	0080		0080		0083	0083
150	Jet Set 150	02>	2810					



PASTIGLIE FRENO RMS - SINTER (RICERCA PER MARCA)











RMS - SINTER BRAKE PADS (SEARCH BY BRAND)

CC	MODELLO MODEL	ANNO YEAR								
			 ANTERIORE - FRONT		 POSTERIORE - REAR		 ANTERIORE FRONT	 POSTERIORE REAR		
			PASTIGLIA ORGANICA - ORGANIC				PASTIGLIA SINTERIZZATA SINTERED			
			 OMOLOGATA HOMOLOGATED	 NON OMOLOGATA NOT HOMOLOGATED	 GANASCE BRAKE SHOES	 OMOLOGATA HOMOLOGATED	 NON OMOLOGATA NOT HOMOLOGATED	 GANASCE BRAKE SHOES		
			22 510	22 512	22 510	22512	22 510	22 510		
150	Jupiter 150	02>	0410		2810		0413			
150	Millenium 150	>00	2730							
150	Millenium 150 (Seconda Serie)	01>	2810		0560					
150	Torpedo 150 4 T	01>	0080				0083			
180	Dragster 180	99>	0080				0083			
250	Jupiter 250	02>	0410		0560		0413			
350	Boss 350 Enduro	-	0010				0013			
350	Cx 350	85>	0010				0013			
350	Road Master 350	-	0010				0013			
JANSHE										
125	Js 1253	02>	0410				0413			
JCM										
125	Europa 125	89>	0080		0080		0083	0083		
125	Oxygene 125	89>	0030							
125	Sr 125	89>	0080		0080		0083	0083		
125	Week End 125	89>	0030							
233	Vega 233	88>	0030							
240	Enduro 240	91>	0030							
240	Europa 240	89>	0080		0080		0083	0083		
240	Oxygene 240	89>	0030							
240	Sr 240	89>	0080		0080		0083	0083		
240	Week End 240	89>	0030							
250	Week End 250	91>	0030							
325	Europa 325	89>	0080				0083			
325	Oxygene 325	89>	0030							
325	Sr 325	89>	0080		0080		0083	0083		
325	Week End 325	89>	0030							
333	Vega 333	87>	0030							
333	Vega 333	88>	0030							
JINCHENG										
125	Jc 125 2A/3A	97>	1070				1073			
125	Jc 125 2B	97>	2630				2633			
150	Jc 150 T-D	06>	0410				0413			
250	Jc 250	06>	0280							
JJ COBAS										
-	Tr 1	85>	0520		0080		0523	0083		
-	Trial	85>	0080		0080		0083	0083		

PASTIGLIE FRENO RMS - SINTER (RICERCA PER MARCA)

RMS - SINTER BRAKE PADS (SEARCH BY BRAND)

















CC	MODELLO MODEL	ANNO YEAR	RMS YOUR BEST PARTNER				SINTER	
			 ANTERIORE - FRONT		 POSTERIORE - REAR		 ANTERIORE FRONT	 POSTERIORE REAR
			PASTIGLIA ORGANICA - ORGANIC				PASTIGLIA SINTERIZZATA SINTERED	
								
			OMOLOGATA HOMOLOGATED	NON OMOLOGATA NOT HOMOLOGATED	GANASCE BRAKE SHOES	OMOLOGATA HOMOLOGATED	NON OMOLOGATA NOT HOMOLOGATED	GANASCE BRAKE SHOES
22 510		22 512	22 510		22512	22 510	22 510	
KAWASAKI								
50	Ar 50	81>	0040					
50	Kmx 50	88>	0040					
50	Ksr 50 I/li	90>	0040		1200			
65	Kx 65	00>05			1440			
80	Ar 80	81>	0040					
80	Kd 80	88>90	0040					
80	Kx 80	88>96	0040		2850		2853	
80	Kx 80	97>00			2850		2853	
80	Kx 80 E2	84>87	0040					
85	Kx 85	01>06			2850		2853	
100	Kg 100 G4	83>	1200					
100	Kx 100	88>91	0040		2850		2853	
100	Kx 100 B7	97>			2850		2853	
125	Ar 125 A1 - Lc	82>	1200					
125	Bn 125	98>99	1440			0061		
125	Bn 125 Eliminator	00>	1420				1423	
125	Kaze 115 R	98>	1070				1073	
125	Kdx 125 A1	90>	0040		1790			
125	Kh 125 Ex	82>83	1200					
125	Kh 125 K1	82>	1440					
125	Kh 125 K2-4 - L1	82>83	1200					
125	Klx 125	10>	1420				1423	
125	Klx 125 D-Tracker	10>	1420				1423	
125	Kmx 125	86>89	1200		0040			
125	Kmx 125	00>			1440			
125	Kx 125	86>	1200		1200			
125	Kx 125	89>94	1420		1790		1423	
125	Kx 125	96>	0920		2630		0923 2633	
125	Kx 125 B1	81>	0040					
125	Kx 125 B2 - C1	82>85	1200					
125	Kx 125 E2 - D1 - E2	87>88			1200			
125	Kx 125 K2-K4	95>	0920		1790		0923	
150	Kr 150	98>	1070		1200		1073	
150	Kr 150 Sport	98>			1200			
200	Kdx 200 C1	86>88	1200					
200	Kdx 200 E1	89>	1200		1790			
200	Kdx 200 E6, H1-H3	94>	0920		1790		0923	
200	Kdx 200 Sr	90>93	1420		1790		1423	



PASTIGLIE FRENO RMS - SINTER (RICERCA PER MARCA)











RMS - SINTER BRAKE PADS (SEARCH BY BRAND)

CC	MODELLO MODEL	ANNO YEAR								
			 ANTERIORE - FRONT		 POSTERIORE - REAR		 ANTERIORE FRONT	 POSTERIORE REAR		
			PASTIGLIA ORGANICA - ORGANIC				PASTIGLIA SINTERIZZATA SINTERED			
			 OMOLOGATA HOMOLOGATED	 NON OMOLOGATA NOT HOMOLOGATED	 GANASCE BRAKE SHOES	 OMOLOGATA HOMOLOGATED	 NON OMOLOGATA NOT HOMOLOGATED	 GANASCE BRAKE SHOES		
			22 510		22 512	22 510		22512	22 510	22 510
200	Kmx 200	88>	0040		1200					
200	Z 200 A6	83>	1200							
220	Kdx 220 Ra4	97>	0920		1790		0923			
250	250 R Ninja	08>	1070		1070		1073	1073		
250	Bj 250 F1/F2	02>03	1250				1253			
250	El 250 All Models	87>94	1490				1493			
250	Er 250 (Z 250 T Scorpion)	83>88	1490				1493			
250	Ex 250 H1 - H2	90>			1200					
250	Ex 250 Ninja	86>87	1490		1490		1493	1493		
250	Gpz 250	85>	1200		1490			1493		
250	Kdx 250 Balius	91>			1200					
250	Kdx 250 Estrella	92>	1200		1200					
250	Kdx 250 K2-K4	95>	0920		2630		0923	2633		
250	Kdx 250 Sr-D	91>	1420		1790		1423			
250	Kl 250 Super Sherpa	00>			1200					
250	Kle 250 Anhelo	93>			1200					
250	Klr 250 All Models	84>	1200							
250	Klx 250	93>	1420		1790		1423			
250	Klx 250	95>97	0920		1790		0923			
250	Klx 250 H1 Super Sherpa	98>			1200					
250	Klx 250 S	09>	1420		2630		1423	2633		
250	Klx 250 Sf	09>	1420		2630		1423	2633		
250	Kmx 250	89>	1200		1200					
250	Kr-1 250 C1 - C3	90>	1150				1153			
250	Kx 250	86>	1200		1200					
250	Kx 250	89>94	1420		1790		1423			
250	Kx 250	94>95	0920		1790		0923			
250	Kx 250	96>	0920		2630		0923	2633		
250	Kx 250 B1	82>	0040							
250	Kx 250 C1 - C2	83>85	1200							
250	Kx 250 E1 - F1	87>88			1200					
250	Kx F 250	04>	0920		1450		0923	1453		
250	Lx 250 Eliminator - Se	90>	1490				1493			
250	Sc 250 Epsilon	02>	0380		0670		0383			
250	Z 250	83>	1490				1493			
250	Z 250 A1 - A2	78>80			1190					
250	Z 250 A3	81>			1190					
250	Z 250 Gp Belt Drive	83>	1490				1493			

PASTIGLIE FRENO RMS - SINTER (RICERCA PER MARCA)

RMS - SINTER BRAKE PADS (SEARCH BY BRAND)

















CC	MODELLO MODEL	ANNO YEAR	RMS YOUR BEST PARTNER				SINTER	
			 ANTERIORE - FRONT		 POSTERIORE - REAR		 ANTERIORE FRONT	 POSTERIORE REAR
			PASTIGLIA ORGANICA - ORGANIC				PASTIGLIA SINTERIZZATA SINTERED	
								
			OMOLOGATA HOMOLOGATED	NON OMOLOGATA NOT HOMOLOGATED	GANASCE BRAKE SHOES	OMOLOGATA HOMOLOGATED	NON OMOLOGATA NOT HOMOLOGATED	GANASCE BRAKE SHOES
22 510		22 512	22 510		22512	22 510	22 510	
250	Z 250 J1	81>	1190					
250	Zxr 250	89>	1200					
250	Zzr 250 (Ex 250 H)	90>93	1200					
252	El 252	97>00	1490				1493	
252	El 252	01>	1070				1073	
300	Klf 300 Bayou	88>04	1200					
300	Klx 300	00>	0920		2630	0923	2633	
300	Klx 300 R	97>	0920		1790	0923		
305	Gpz 305 All Models	83>96	1200					
400	Ex 4 400	95>			1200			
400	Gpx 400	85>	1200		1490			
400	Gpz 400	85>	1200		1490			
400	Kle 400	91>			1200			
400	Kle 400 Vulcan	90>	1490			1493		
400	Klx 400 R	03>	0920		2630	0923	2633	
400	Klx 400 Sr	03>	0920		2630	0923	2633	
400	Lx 400 Eliminator - Se	90>	1200					
400	Vn 400 Classic	99>	1240			1243		
400	Vn 400 Vulcan	95>	1490			1493		
400	Xantus 400	92>			1200			
400	Z 400 F2	85>	1200		1490		1493	
400	Zl 400	86>87	1490			1493		
400	Zl 400 Eliminator	88>92	1490		1490	1493	1493	
400	Zl 400 Eliminator	93>			1490		1493	
400	Zr 400 A1 - F	83>	1200					
400	Zr 400 Zephyr	93>			1220		1223	
400	Zrx 400	98>	1170		1220	1173	1223	
400	Zrx 400 (Zr 400 E2)	99>	2120		1220	3013	1223	
400	Zx 400 C2	85>	1200		1490		1493	
400	Zx 400 L	92>			0720		0723	
400	Zxr 400	91>	1150			1153		
400	Zxr 400	94>			1220		1223	
400	Zxr 400 (Zx 400L) Rr	92>			0720		0723	
400	Zzr 400	90>92	1150			1153		
400	Zzr 400	93>	1150		1220	1153	1223	
450	Kx F 450	06>	0920		1450	0923	1453	
450	Kx F 450 Efi	09>	0920		1450	0923	1453	
450	Z 450 Ltd Liquid Cooled	86>89	1490			1493		



PASTIGLIE FRENO RMS - SINTER (RICERCA PER MARCA)











RMS - SINTER BRAKE PADS (SEARCH BY BRAND)

CC	MODELLO MODEL	ANNO YEAR	 YOUR BEST PARTNER							
			 ANTERIORE - FRONT		 POSTERIORE - REAR		 ANTERIORE FRONT	 POSTERIORE REAR		
			PASTIGLIA ORGANICA - ORGANIC				PASTIGLIA SINTERIZZATA SINTERED			
			 OMOLOGATA HOMOLOGATED	 NON OMOLOGATA NOT HOMOLOGATED	 GANASCE BRAKE SHOES	 OMOLOGATA HOMOLOGATED	 NON OMOLOGATA NOT HOMOLOGATED	 GANASCE BRAKE SHOES		
			22 510		22 512	22 510		22512	22 510	22 510
500	En 500 All Models	90>04	1490				1493			
500	Er-5 500 Twister	01>07	1240				1243			
500	Gpz 500 S	87>	1490				1493			
500	Gpz 500 S	88>	1200							
500	Gpz 500 S	89>92	1200		1490		1493			
500	Gpz 500 S	93>	1150				1153			
500	Gpz 500 S	94>97					1200			
500	Kle 500	91>93					1200			
500	Kle 500	00>					1200			
500	Kr 500 Es	93>	1420		1790		1423			
500	Kx 500	86>	1200				1200			
500	Kx 500	89>94	1420		1790		1423			
500	Kx 500	94>95	0920		1790		0923			
500	Kx 500 A1 - A2	83>85	1200							
500	Kx 500 C1	87>88					1200			
500	Kx 500 E8/E9	96>	0920		2630		0923 2633			
500	Z 500 F	83>	1200							
500	Zr 500 A1	83>	1200							
500	Zz-R 500	90>	1150				1153			
550	Gt 550	83>01	1200							
550	Z 550 F	83>	1200							
550	Z 550 G1 Shaft	83>	1200							
550	Z 550 Gp	84>	1490		1490		1493			
550	Zr 550 A1	83>84	1200							
550	Zr 550 Zephyr	93>					1220 1223			
570	Klr 570	88>	1200							
600	Gpz 600 R	85>	1490		1490		1493 1493			
600	Kle 600	92>					1200			
600	Klr 600	84>	1200							
600	Klr 600 Electric Starter	85>	1200							
600	Klr 600 S	92>	1200							
600	Klx 600 R	93>	0920		1790		0923			
600	Zl 600 A1/A2	85>94	1490				1493			
600	Zx 6R 600 D1-D2 (Dx 6)	90>93	1150				1153			
600	Zx 6R 600 Ninja	94>97	1150		1220		1153 1223			
600	Zx 6R 600 Ninja	98>02	1170		1220		1173 1223			
600	Zx 6R 600 Ninja	07>					2943 1223			
600	Zx 6Rr 600 Ninja	05>06					2983 1223			

PASTIGLIE FRENO RMS - SINTER (RICERCA PER MARCA)

RMS - SINTER BRAKE PADS (SEARCH BY BRAND)

















CC	MODELLO MODEL	ANNO YEAR	RMS YOUR BEST PARTNER				SINTER	
			 ANTERIORE - FRONT		 POSTERIORE - REAR		 ANTERIORE FRONT	 POSTERIORE REAR
			PASTIGLIA ORGANICA - ORGANIC				PASTIGLIA SINTERIZZATA SINTERED	
								
			OMOLOGATA HOMOLOGATED	NON OMOLOGATA NOT HOMOLOGATED	GANASCE BRAKE SHOES	OMOLOGATA HOMOLOGATED	NON OMOLOGATA NOT HOMOLOGATED	GANASCE BRAKE SHOES
22 510		22 512	22 510		22512	22 510	22 510	
600	Zzr 600	90>92	1150			1153		
600	Zzr 600	93>	1150		1220	1153	1223	
636	Zx 6R 636 Ninja	02>	1170		1220	1173	1223	
636	Zx 6R 636 Ninja	03>06			1220	2983	1223	
650	Er - 6F 650 (Pinza Dx)	06>09	1250		1220	1253	1223	
650	Er - 6F 650 (Pinza Sx)	06>09	1240		1220	1243	1223	
650	Er - 6F 650 Abs (Pinza Dx)	06>09	1250		1220	1253	1223	
650	Er - 6F 650 Abs (Pinza Sx)	06>09	1240		1220	1243	1223	
650	Er - 6N 650 (Pinza Dx)	06>09	1250		1220	1253	1223	
650	Er - 6N 650 (Pinza Sx)	06>09	1240		1220	1243	1223	
650	Er - 6N 650 Abs (Pinza Dx)	06>09	1250		1220	1253	1223	
650	Er- 6N 650 Abs (Pinza Sx)	06>09	1240		1220	1243	1223	
650	Kl 650 Tengai	89>			1200			
650	Kle 650 Versys (Pinza Dx)	07>10	1250		1220	1253	1223	
650	Kle 650 Versys (Pinza Sx)	07>10	1240		1220	1243	1223	
650	Kle 650 Versys Abs (Pinza Dx)	07>10	1250		1220	1253	1223	
650	Kle 650 Versys Abs (Pinza Sx)	07>10	1240		1220	1243	1223	
650	Klr 650	87>94			1200			
650	Klr 650	95>	1240		1200	1243		
650	Klr 650	00>	1240		1200	1243		
650	Klr 650	08>	1420		1070	1423	1073	
650	Klx 650 R	93>	0920		1790	0923		
650	W 650 (Ej 650)	99>06	1250			1253		
700	Vn 700 A2-A10	86>94	1490			1493		
700	Vn 700 Vulcan	85>	1490			1493		
700	Z 700 (Pinza Dx)	04>	1250		1220	1253	1223	
700	Z 700 (Pinza Sx)	04>	1240		1220	1243	1223	
750	750 Belt Drive	85>	1490		1490	1493	1493	
750	750 Turbo	85>	1490		1490	1493	1493	
750	750 Vulcan	89>93	1490			1493		
750	Gpz 750	85>86	1490		1490	1493	1493	
750	Gpz 750 R1	85>87	1490		1490	1493	1493	
750	Gt 750	85>	1490		1490	1493	1493	
750	Vn 750	88>	1490		1490	1493	1493	
750	Vn 750 Twin	86>	1490			1493		
750	Vn 750 Vulcan	90>	1490			1493		
750	Z 750	07>09	0870		0930	0873	0933	
750	Z 750 Abs	07>09	0870		0930	0873	0933	



PASTIGLIE FRENO RMS - SINTER (RICERCA PER MARCA)

RMS - SINTER BRAKE PADS (SEARCH BY BRAND)

CC	MODELLO MODEL	ANNO YEAR								
			 ANTERIORE - FRONT		 POSTERIORE - REAR		 ANTERIORE FRONT	 POSTERIORE REAR		
			PASTIGLIA ORGANICA - ORGANIC				PASTIGLIA SINTERIZZATA SINTERED			
			 OMOLOGATA HOMOLOGATED	 NON OMOLOGATA NOT HOMOLOGATED	 GANASCE BRAKE SHOES	 OMOLOGATA HOMOLOGATED	 NON OMOLOGATA NOT HOMOLOGATED	 GANASCE BRAKE SHOES		
			22 510	22 512	22 510	22512	22 510	22 510		
750	Z 750 Gp	83>	1490		1490		1493	1493		
750	Z 750 J (Pinza Dx) (Zr)	04>05	1250		1220		1253	1223		
750	Z 750 J (Pinza Sx) (Zr)	04>05	1240		1220		1243	1223		
750	Z 750 Ltd Twin K1	83>	1490				1493			
750	Z 750 R	11>			0930		2983	0933		
750	Z 750 R Abs	11>			0930		2983	0933		
750	Z 750 S (Pinza Dx) (Zr)	05>06	1250		1220		1253	1223		
750	Z 750 S (Pinza Sx) (Zr)	05>06	1240		1220		1243	1223		
750	Zr 750 Zephyr	96>	1240				1243			
750	Zr-7 750 (Pinza Dx)	99>	1250		1250		1253	1253		
750	Zr-7 750 (Pinza Sx)	99>	1240		1250		1243	1253		
750	Zr-7S 750 (Pinza Dx)	01>	1250		1250		1253	1253		
750	Zr-7S 750 (Pinza Sx)	01>	1240		1250		1243	1253		
750	Zx 750 A1	83>	1490		1490		1493			
750	Zx 750 E1 Turbo	83>	1490		1490		1493			
750	Zx-7 750 R Ninja	89>95	1150		1200		1153			
750	Zx-7 750 R Ninja	96>	1170		1200		1173			
750	Zx-7 750 Rr Ninja N1	96>						3113		
750	Zxr 750	89>90	1150		0720		1153	0723		
750	Zxr 750 R	93>	1150		0720		1153	0723		
750	Zxr 750 R Stinger / Ninja	91>92	1150				1153			
800	Vn 800	95>98	1490				1493			
800	Vn 800 Classic	96>99	1240				1243			
800	Vn 800 Drifter	99>	1240		1250		1243	1253		
800	W 800 Abf (Ej 800)	11>	1250				1253			
800	Z R	13						3323		
800	Z E	13						3323		
850	Vn 850	95>	1490				1493			
900	Gpz 900	85>	1490		1490		1493	1493		
900	Gpz 900 R	90>	1150				1153			
900	Gpz 900 R Ninja	84>89	1490		1490		1493	1493		
900	Vn 900 Classic	06>	1240		1250		1243	1253		
900	Vn 900 Custom	07>	1240		1250		1243	1253		
900	X-9 R 900 Ninja	94>95	1150		1220		1153	1223		
900	Z 900 Z1a - Z1b	74>76	1490							
900	Zx-9 900 R Ninja	96>01	1170		1220		1173	1223		
900	Zx-9 900 R Ninja	02>			1220		2993	1223		

PASTIGLIE FRENO RMS - SINTER (RICERCA PER MARCA)

RMS - SINTER BRAKE PADS (SEARCH BY BRAND)

















CC	MODELLO MODEL	ANNO YEAR	RMS YOUR BEST PARTNER				SINTER	
			ANTERIORE - FRONT		POSTERIORE - REAR		ANTERIORE FRONT	POSTERIORE REAR
			PASTIGLIA ORGANICA - ORGANIC				PASTIGLIA SINTERIZZATA SINTERED	
			OMOLOGATA HOMOLOGATED	NON OMOLOGATA NOT HOMOLOGATED	GANASCE BRAKE SHOES	OMOLOGATA HOMOLOGATED	NON OMOLOGATA NOT HOMOLOGATED	GANASCE BRAKE SHOES
22 510		22 512	22 510		22512	22 510	22 510	
1000	Gpz 1000 Rx - Ry	86>	1490		1490		1493	1493
1000	Gtr 1000	86>93	1490		1490		1493	1493
1000	Klv 1000 (Pinza Dx)	04>	1250		0930		1253	0933
1000	Klv 1000 (Pinza Sx)	04>	1240		0930		1243	0933
1000	Vn 1000 Vulcan	87>	1490		1490		1493	1493
1000	Z 1000	07>09			0930		2943	0933
1000	Z 1000 - Abs	10>			1220		2963	1223
1000	Z 1000 (Zr)	03>06			1220		2993	1223
1000	Z 1000 Abs	07>09			0930		2943	0933
1000	Z 1000 Abs	10>			1220		2963	1223
1000	Z 1000 Gtr	94>			1490			1493
1000	Z 1000 Gtr (Zg 1000)	86>93	1490		1490		1493	1493
1000	Z 1000 Sx - Abs	11>			1220		2963	1223
1000	Zl 1000 All Models	87>	1490		1490		1493	1493
1000	Zx 10R 1000 Ninja	04>07			1220		2983	1223
1000	Zx 10R 1000 Ninja	08>10			1220		2963	1223
1000	Zx 10R 1000 Ninja	11>					2963	2933
1000	Zx 10R 1000 Ninja Abs	11>					2963	2933
1000	Zzr 1000	91>	1150				1153	
1100	Gpx 1100 (Zx 1100 A1)	83>	1490		1490		1493	1493
1100	Gpz 1100 (Pinza Dx)	95>	1250		1220		1253	1223
1100	Gpz 1100 (Pinza Sx)	95>	1240		1220		1243	1223
1100	Vn 1100	87>	1490		1490		1493	1493
1100	Z 1100 R1	84>	1490		1490		1493	1493
1100	Zr 1100 C1	97>	1170		0720		1173	0723
1100	Zr 1100 Zephir	97>	1240				1243	
1100	Zr 1100 Zephyr (Pinza Dx)	96>	1250				1253	
1100	Zr 1100 Zephyr (Pinza Sx)	96>	1240				1243	
1100	Zr 1100 Zephyr (Zr 1100 A)	92>96	1150				1153	
1100	Zrx 1100	96>			0720			0723
1100	Zx 1100	93>	1150				1153	
1100	Zx 1100 A1	83>84	1490		1490		1493	1493
1100	Zzr 1100 Gt (Zx 1100 C)	90>92	1150				1153	
1100	Zzr 1100 Gt (Zx 1100 D)	93>	1150		1190		1153	
1200	Kz 1200	87>	1490		1490		1493	1493
1200	Zg 1200	86>90	1490		1490		1493	1493
1200	Zg 1200 Voyager	86>	1490		1490		1493	1493
1200	Zrx 1200	01>03	1170				1173	



PASTIGLIE FRENO RMS - SINTER (RICERCA PER MARCA)











RMS - SINTER BRAKE PADS (SEARCH BY BRAND)

CC	MODELLO MODEL	ANNO YEAR	 YOUR BEST PARTNER							
			 ANTERIORE - FRONT		 POSTERIORE - REAR		 ANTERIORE FRONT	 POSTERIORE REAR		
			PASTIGLIA ORGANICA - ORGANIC				PASTIGLIA SINTERIZZATA SINTERED			
			 OMOLOGATA HOMOLOGATED	 NON OMOLOGATA NOT HOMOLOGATED	 GANASCE BRAKE SHOES	 OMOLOGATA HOMOLOGATED	 NON OMOLOGATA NOT HOMOLOGATED	 GANASCE BRAKE SHOES		
			22 510		22 512	22 510		22512	22 510	22 510
1200	Zrx 1200	04>	1150				1153			
1200	Zrx 1200 R - S	00>			0720			0723		
1200	Zrx 1200 R - S	01>03	1170				1173			
1200	Zrx 1200 R - S	04>	1150				1153			
1200	Zx 12R 1200 Ninja	00>03	1170			0720	1173	0723		
1200	Zx 12R 1200 Ninja	04>06				0720	2983	0723		
1200	Zz-R 1200	02>	1150			0720	1153	0723		
1400	Gtr 1400	07>08					2943	3113		
1400	Zzr 1400 A6f	06>09					2943	3113		
1400	Zzr 1400 Abs B6f	06>09					2943	3113		
1500	Vn 1500 All Models	87>93	1490			1490	1493	1493		
1500	Vn 1500 Classic Tourer (Pinza Dx)	98>	1250			1490	1253	1493		
1500	Vn 1500 Classic Tourer (Pinza Sx)	98>	1240			1490	1243	1493		
1500	Vn 1500 Classic Tourer F1 (Pinza Dx)	00>02	1250			1490	1253	1493		
1500	Vn 1500 Classic Tourer F1 (Pinza Sx)	00>02	1240			1490	1243	1493		
1500	Vn 1500 D1/D2 Classic	96>98	1240			1490	1243	1493		
1500	Vn 1500 Drifter	99>02	1240			1250	1243	1253		
1500	Vn 1500 Mean Streak	02>03	1170			1250	1173	1253		
1500	Vn 1500 Sumo	88>	1490			1490	1493	1493		
1600	Vn 1600 Classic (Pinza Dx)	03>08	1250			1490	1253	1493		
1600	Vn 1600 Classic (Pinza Sx)	03>08	1240			1490	1243	1493		
1600	Vn 1600 Mean Streak	04>	1170			1250	1173	1253		
1600	Vn 1600 Mean Streak	05>				1250	2983	1253		
1700	Vn 1700 Classic (Pinza Dx)	09>	1250			1490	1253	1493		
1700	Vn 1700 Classic (Pinza Sx)	09>	1240			1490	1243	1493		
1700	Vn 1700 Classic Tourer (Pinza Dx)	09>	1250			1490	1253	1493		
1700	Vn 1700 Classic Tourer (Pinza Sx)	09>	1240			1490	1243	1493		
1700	Vn 1700 Voyager	09>	1150			1250	1153	1253		
2000	Vn 2000	04>	1150			1250	1153	1253		
KAWASAKI ATV										
250	Ksf 250 Mojave A1/A15	87>01				2850		2853		
250	Kxf 250 Tecate A1/A2	87>88				2850		2853		
250	Kxt 250 Tecate A1	84>				0040				
250	Kxt 250 Tecate A2 - B1	85>86	1200			1200				
250	Kxt 250 Tecate B2	87>	1200			2850		2853		
300	Kef 300 Lakota (2Wd) A1/ A6	95>00				2850		2853		
300	Kef 300 Lakota Sport	01>				2850		2853		
300	Klf 300 Bayou B1/B14	88>01	1200							

PASTIGLIE FRENO RMS - SINTER (RICERCA PER MARCA)

RMS - SINTER BRAKE PADS (SEARCH BY BRAND)

















CC	MODELLO MODEL	ANNO YEAR	RMS YOUR BEST PARTNER				SINTER	
			 ANTERIORE - FRONT		 POSTERIORE - REAR		 ANTERIORE FRONT	 POSTERIORE REAR
			PASTIGLIA ORGANICA - ORGANIC				PASTIGLIA SINTERIZZATA SINTERED	
								
OMOLOGATA HOMOLOGATED	NON OMOLOGATA NOT HOMOLOGATED	GANASCE BRAKE SHOES	OMOLOGATA HOMOLOGATED	NON OMOLOGATA NOT HOMOLOGATED	GANASCE BRAKE SHOES			
22 510		22 512	22 510		22512	22 510	22 510	
300	Klf 300 Bayou C1/C12 (Pinza Dx)	89>	1070				1073	
300	Klf 300 Bayou C1/C12 (Pinza Sx)	89>90	1420				1423	
300	Kvf 300 Prairie 2X4 B1/B3	99>01	1440					
300	Kvf 300 Prairie 4X4 A1/A3	99>01	1440					
400	Kfx 400	02>	1440					
400	Klf 400 Bayou 4X4 B1/B7 (Pinza Dx)	93>99	1070				1073	
400	Klf 400 Bayou 4X4 B1/B7 (Pinza Sx)	93>99	1420				1423	
400	Kvf 400 Prairie 2X4 D1/D3	99>01	1440					
400	Kvf 400 Prairie 4X4 C1/C3	99>01	1440					
400	Kvf 400 Prairie A1/A2 - B1	97>98	1440					
650	Kvf 650 Brute Force 4X4i (Pinza Dx)	05>	1420				1423	
650	Kvf 650 Brute Force 4X4i (Pinza Sx)	05>	1070				1073	
750	Kvf 750 Brute Force 4X4i (Pinza Dx)	05>	1420				1423	
750	Kvf 750 Brute Force 4X4i (Pinza Sx)	05>	1070				1073	
KEEWAY								
50	50 Hurricane	06>	0040					
50	F-Nkd 50	10>					0061	
50	Ry8 50	07>09					0061	
50	Ry8 50	10>	2590				2593	
50	Tx 50 Sm	10>	0560					
90	90 Hurricane	06>	0040					
100	100 Partner	06>	0350				0353	
110	110 Partner	06>	0350				0353	
125	125 Arn	06>	0190				0193	
125	125 Enduro	07>	0360		0010		0363	0013
125	125 Speed	06>	0030		0350		0353	
125	125 Superlight	06>	0580				0583	
125	125 X-Ray	07>	0360		0010		0363	0013
125	Focus	06>07	0040				0451	
125	Matrix	06>09	0040				0451	
125	Tx 125 Sm	10>	0560					
150	150 Arn	06>	0190				0193	
150	150 Speed	06>	0030		0350		0353	
150	150 Superlight	06>	0580				0583	
150	Matrix	07>09	0240		0451			
250	250 Land Cruiser	06>	0580				0583	
250	250 Supershadow	06>	0410				0413	



PASTIGLIE FRENO RMS - SINTER (RICERCA PER MARCA)













RMS - SINTER BRAKE PADS (SEARCH BY BRAND)

CC	MODELLO MODEL	ANNO YEAR								
			 ANTERIORE - FRONT		 POSTERIORE - REAR		 ANTERIORE FRONT	 POSTERIORE REAR		
			PASTIGLIA ORGANICA - ORGANIC				PASTIGLIA SINTERIZZATA SINTERED			
			 OMOLOGATA HOMOLOGATED	 NON OMOLOGATA NOT HOMOLOGATED	 GANASCE BRAKE SHOES	 OMOLOGATA HOMOLOGATED	 NON OMOLOGATA NOT HOMOLOGATED	 GANASCE BRAKE SHOES		
			22 510	22 512	22 510	22512	22 510	22 510		
KOTIR										
50	Rs 50	90>	0061		0061					
KRAMIT										
250	Gs 250	97>	0430		1330		1333			
250	Mx 250	97>	0430		1330		1333			
250	Sm 250	97>	0430		1330		1333			
KREIDLER										
25	Florett 25 XL	99>	2800							
50	Florett 50 XL	99>	2800		0061					
125	Enduro 125	07>	0580				0583			
125	Florett 125	07>	1070				1073			
125	Florett 125 Rmc-F	07>	1070				1073			
125	Supermoto 125	07>	0580				0583			
KTM										
50	Chrono 50 Scooter	94>	0530		0091		0533			
50	Comet 50 PL-RL-RLW-RS4L-TS	-	0010				0013			
50	Go 50 Scooter	94>	0070		0091					
50	Mx 50	87>	0010				0013			
50	Rsv 50	86>	0010				0013			
50	Sx 50 Junior Lc	02>04	3220				3223			
50	Sx 50 Pro Junior Lc	02>	3220				3223			
50	Sx 50 Pro Senjor Lc	02>03	3220				3223			
50	Sx 50 Pro Senjor Lc	04>	3220		3220		3223 3223			
50	Sx 50 Senjor Adventure	04>	3220				3223			
50	Sx 50 Supermoto	06>	3220		3220		3223 3223			
60	Sx 60	98>99	0080				0083			
65	Sx 65	00>01	0080				0083			
65	Sx 65	04>08			3220		3223			
80	L-Pl-RI-Rs-Rsl-Bora 80	-	0010		0010		0013			
80	Mx 80 Gr - Super Mini	86>	0010				0013			
125	Baja 125	86>	0010				0013			
125	Duke 125	11>			1330		1333			
125	Exc 125	89>91	1200				1200			
125	Exc 125	92>93	0430				0430			
125	Exc 125	98>03	0430		1330		1333			
125	Exc 125	04>	0430		0750		0753			
125	Exe 125	00>	0430		1330		1333			
125	Gs 125	86>	0010		0010		0013			
125	Gs 125	86>87	0530		0530		0533			

PASTIGLIE FRENO RMS - SINTER (RICERCA PER MARCA)

RMS - SINTER BRAKE PADS (SEARCH BY BRAND)

















CC	MODELLO MODEL	ANNO YEAR						
			 ANTERIORE - FRONT		 POSTERIORE - REAR		 ANTERIORE FRONT	 POSTERIORE REAR
			PASTIGLIA ORGANICA - ORGANIC				PASTIGLIA SINTERIZZATA SINTERED	
								
			OMOLOGATA HOMOLOGATED	NON OMOLOGATA NOT HOMOLOGATED	GANASCE BRAKE SHOES	OMOLOGATA HOMOLOGATED	NON OMOLOGATA NOT HOMOLOGATED	GANASCE BRAKE SHOES
125	Lc2 125	98>	0430		1330		1333	
125	Lc2 Sting 125	97>98	0520		1330	0523	1333	
125	Mx 125	85>	0010			0013		
125	Mx 125	86>	0010		0010	0013		
125	Mx 125	86>87	0530		0530	0533		
125	Mx 125	89>91	1200		1200			
125	Mx 125	92>93	0430		0430			
125	Supermoto 125	00>	0430		1330		1333	
125	Sx 125	96>03	0430		1330		1333	
125	Sx 125	04>	0430		0750		0753	
125	Duke	11	3310			3313		
144	Sx 144	07>08	0430		0750		0753	
150	Sx 150	09>	0430		0750		0753	
200	Egs 200	98>99	0430		1330		1333	
200	Exc 200	98>03	0430		1330		1333	
200	Exc 200	04>	0430		0750		0753	
200	Sx 200	03>04	0430		0750		0753	
200	Duke	12	3310			3313		
250	Baja 250	86>	0010			0013		
250	Exc 250	92>	0430		1200			
250	Exc 250	93>	0430		1200			
250	Exc 250	94>03	0430		1330		1333	
250	Exc 250	04>	0430		0750		0753	
250	Exc 250 4T	99>03	0430		1330		1333	
250	Exc 250 4T	04>06	0430		0750		0753	
250	Exc-F 250	07>09	0430		0750		0753	
250	Exc-R 250	01>03	0430		1330		1333	
250	Exc-R 250	04>06	0430		0750		0753	
250	Gs 250	86>	0010		0010	0013		
250	Gs 250	86>87	0530		0530	0533		
250	Mx 250	85>	0010			0013		
250	Mx 250	86>	0010		0010	0013		
250	Mx 250	86>87	0530		0530	0533		
250	Mx 250	92>93	0430		1200			
250	Mx 250	94>02	0430		1330		1333	
250	Sx 250	96>02	0430		1330		1333	
250	Sx 250	03>	0430		0750		0753	
250	Sx-F 250	06>	0430		0750		0753	



PASTIGLIE FRENO RMS - SINTER (RICERCA PER MARCA)











RMS - SINTER BRAKE PADS (SEARCH BY BRAND)

CC	MODELLO MODEL	ANNO YEAR								
			 ANTERIORE - FRONT		 POSTERIORE - REAR		 ANTERIORE FRONT	 POSTERIORE REAR		
			PASTIGLIA ORGANICA - ORGANIC				PASTIGLIA SINTERIZZATA SINTERED			
			 OMOLOGATA HOMOLOGATED	 NON OMOLOGATA NOT HOMOLOGATED	 GANASCE BRAKE SHOES	 OMOLOGATA HOMOLOGATED	 NON OMOLOGATA NOT HOMOLOGATED	 GANASCE BRAKE SHOES		
			22 510	22 512	22 510	22512	22 510	22 510		
300	Exc 300 E	04>	0430		0750			0753		
300	Exc 300 Egs	93>	0430		1200					
300	Exc 300 Egs	94>03	0430		1330			1333		
300	Gs 300	86>	0010		0010		0013			
300	Gs 300	86>87	0530		0530		0533			
350	Country 350	85>	0010				0013			
350	Exc/Egs 350	89>90	1200		1200					
350	Gs 350	83>	0010				0013			
360	Exc 360	96>97	0430		1330			1333		
360	Sx 360	96>97	0430		1330			1333		
380	Exc 380	98>02	0430		1330			1333		
380	Mxc 380	98>02	0430		1330			1333		
380	Sx 380	98>02	0430		1330			1333		
390	Gs 390	83>	0010				0013			
390	Duke	13	3310				3313			
400	Duke 400	94>	0520		1200		0523			
400	Duke 400	95>	0520		1330		0523	1333		
400	Enduro 400	87>	0530		0530		0533			
400	Exc 400	00>03	0430		1330			1333		
400	Exc 400	04>	0430		0750			0753		
400	Lc4 400	93>94	0430		1200					
400	Lc4 Egs 400	95>97	0430		1330			1333		
400	Lc4 Sc 400	98>00	0430		1330			1333		
400	Lc4 Sxc 400	98>00	0430		1330			1333		
400	Sx 400	00>02	0430		1330			1333		
400	Sxc 400	99>00	0430		1330			1333		
450	Exc 450	03>	0430		1330			1333		
450	Exc 450	04>09	0430		0750			0753		
450	Exc-R 450	08>	0430		0750			0753		
450	Sx 450	03>	0430		0750			0753		
450	Sx 450 Smr (Fte Caliper)	04>06			0750			0753		
450	Sx Sm 450 Factory Replica	04>	0520		0750		0523	0753		
450	Sx-F 450	07>	0430		0750			0753		
450	Xc-F 450	08>	0430		0750			0753		
495	Mx 495	82>83	0010				0013			
500	Exc/Mx 500	92>	0430		1200					
500	Exc/Mx 500	94>95	0430		1330			1333		
500	Exc/Mx 500 (Pinze Brembo)	89>91	1200		1200					

PASTIGLIE FRENO RMS - SINTER (RICERCA PER MARCA)

RMS - SINTER BRAKE PADS (SEARCH BY BRAND)

















CC	MODELLO MODEL	ANNO YEAR	RMS YOUR BEST PARTNER				SINTER	
			 ANTERIORE - FRONT		 POSTERIORE - REAR		 ANTERIORE FRONT	 POSTERIORE REAR
			PASTIGLIA ORGANICA - ORGANIC				PASTIGLIA SINTERIZZATA SINTERED	
								
			OMOLOGATA HOMOLOGATED	NON OMOLOGATA NOT HOMOLOGATED	GANASCE BRAKE SHOES	OMOLOGATA HOMOLOGATED	NON OMOLOGATA NOT HOMOLOGATED	GANASCE BRAKE SHOES
22 510		22 512	22 510		22512	22 510	22 510	
500	Gs 500	83>	0010		0013			
500	Lc4 Exc/Egs 500	92>	0430		1200			
500	Lc4 Exc/Egs 500 (Pinze Brembo)	90>91	1200		1200			
500	Lc4 Exc/Egs 500 (Pinze Grimeca)	90>91	1200		1200			
500	Mx 500	86>87	0530		0530		0533	
500	Mx/Mxc 500	85>	0010		0010		0013	
500	Mx/Mxc 500	86>	0010		0010		0013	
505	Sx-F 505	07>08	0430		0750		0753	
505	Xc-F 505	09>	0430		0750		0753	
520	Exc 520	00>02	0430		1330		1333	
520	Sx 520	00>02	0430		1330		1333	
525	Exc 525	03>	0430		1330		1333	
525	Exc 525	04>07	0430		0750		0753	
525	Sx 525	03>	0430		1330		1333	
525	Sx 525	04>06	0430		0750		0753	
525	Sx 525 Smr (Fte Caliper)	04>			0750		0753	
530	Exc-R 530	08>	0430		0750		0753	
540	Sxc 540	98>00	0430		1330		1333	
550	Gxe 550	86>	0010		0010		0013	
550	Gxe 550	86>87	0530		0530		0533	
550	Mx 550	87>	0530		0530		0533	
560	Sx 560 Smr	06>			0750		0753	
600	Enduro 600	86>	0010		0010		0013	
600	Enduro 600	86>87	0530		0530		0533	
600	Gs 600	85>	0010		0010		0013	
600	Xc/Xce 600	85>	0010		0010		0013	
620	Duke 620	96>98	0520		0010		0523 0013	
620	Lc4 620 Competition	99>	0430		1330		1333	
620	Lc4 620 Competition Supermoto	00>	0430		1330		1333	
620	Lc4 620 Rxc	95>	0430		1330		1333	
620	Lc4 620 Supercompetition	01>	0430		1330		1333	
620	Sc 620	99>	0430		1330		1333	
620	Sx 620	95>99	0430		1330		1333	
625	Lc4 Sc 625 Supermoto	02>04	0430		1330		1333	
625	Smc 625	05>	1100		1330		1103 1333	
625	Sxc 625	03>04	0430		1330		1333	
640	Duke 640	99>02	0520		1330		0523 1333	
640	Duke 640	03>	1100		1330		1103 1333	



PASTIGLIE FRENO RMS - SINTER (RICERCA PER MARCA)

RMS - SINTER BRAKE PADS (SEARCH BY BRAND)

CC	MODELLO MODEL	ANNO YEAR								
			 ANTERIORE - FRONT		 POSTERIORE - REAR		 ANTERIORE FRONT	 POSTERIORE REAR		
			PASTIGLIA ORGANICA - ORGANIC				PASTIGLIA SINTERIZZATA SINTERED			
			 OMOLOGATA HOMOLOGATED	 NON OMOLOGATA NOT HOMOLOGATED	 GANASCE BRAKE SHOES	 OMOLOGATA HOMOLOGATED	 NON OMOLOGATA NOT HOMOLOGATED	 GANASCE BRAKE SHOES		
			22 510	22 512	22 510	22512	22 510	22 510		
640	Lc4 640 Adventure	98>04	0430		1330			1333		
640	Lc4 640 Adventure	05>	1010		1330		1013	1333		
640	Lc4 640 Supermoto	03>	0520		1330		0523	1333		
640	Lc4 640 Supermoto	04>	1100		1330		1103	1333		
640	Lc4 E 640	98>06	0430		1330			1333		
640	Lc4-E 640 Enduro	99>	0430		1330			1333		
640	Lc4-E 640 Supermoto	99>02	0430		1330			1333		
660	Lc4 660 Sm Factory Replica	02>03	0520		1330		0523	1333		
660	Lc4-E 660 Rallye	01>	0430		1330			1333		
660	Smc 660 Supermoto	03>	0520		1330		0523	1333		
660	Smc 660 Supermoto	04>06	1100		1330		1103	1333		
690	Lc4 690 Duke	08>	2860		1330		2863	1333		
690	Lc4 690 Enduro	08>	1010		1330		1013	1333		
690	Lc4 690 Enduro R	09>	1010		1330		1013	1333		
690	Lc4 690 Sm	07>	2860		1330		2863	1333		
690	Lc4 690 Smc	08>	2860		1330		2863	1333		
690	Lc4 690 Supermoto R	08>	2860		1330		2863	1333		
950	Lc8 950 Adventure / S	02>	1010		1330		1013	1333		
950	Lc8 950 Sm / Sm R	05>	2860		0430		2863			
950	Lc8 950 Superenduro / R	06>	1010		0430		1013			
990	Lc8 990 Adventure / S	06>11	1010		0430		1013			
990	Lc8 990 Super Duke / R	04>09	2860		1330		2863	1333		
990	Lc8 990 Supermoto	07>	1010		0430		1013			
990	Lc8 990 Supermoto T	09>	1010		0430		1013			
1190	Rc8 1190	08>			0490		2923	0493		
1190	Rc8 1190 R	09>			0490		2923	0493		
1190	Rc8 1190 RTrack	11>			0490		2923	0493		
KYMCO										
50	Agility 50	05>08	0350				0353			
50	Agility 50 2T R 16	10>	2710			0611				
50	Agility 50 4T R 10	06>08	0580				0353			
50	Agility 50 4T R 12	07>08	0580				0353			
50	Agility 50 4T R 16	08>	2710			0611				
50	Agility 50 Rs Naked 2T	10>	0350				0353			
50	Agility City 50 R16 (4T/2T)	08>	2710			0611				
50	B&w 50	04>	0350				0353			
50	Calypso	97>		0240						
50	Cobra 50 Cross	01>	2630				2633			

PASTIGLIE FRENO RMS - SINTER (RICERCA PER MARCA)

RMS - SINTER BRAKE PADS (SEARCH BY BRAND)

















CC	MODELLO MODEL	ANNO YEAR	RMS YOUR BEST PARTNER				SINTER	
			ANTERIORE - FRONT		POSTERIORE - REAR		ANTERIORE FRONT	POSTERIORE REAR
			PASTIGLIA ORGANICA - ORGANIC				PASTIGLIA SINTERIZZATA SINTERED	
			OMOLOGATA HOMOLOGATED	NON OMOLOGATA NOT HOMOLOGATED	GANASCE BRAKE SHOES	OMOLOGATA HOMOLOGATED	NON OMOLOGATA NOT HOMOLOGATED	GANASCE BRAKE SHOES
22 510		22 512	22 510		22512	22 510	22 510	
50	Cobra 50 Cross / Racer	99>00	2630				2633	
50	Cobra 50 Exclusive / Racer	01>	2630				2633	
50	Cx 50 Curio Super	94>	2630				2633	
50	Dd 50 Sniper	94>	2630		9175			2633
50	Dink 50	97>	0350				0353	
50	Dink 50 4T	07>	0350				0353	
50	Djx-Djy-Djw	93>93			0091			0070
50	Fever Zx - Fever Zx Eu2	95>04	2360				0070	
50	Filly 50 Lx	02>	0580				0583	
50	Heroism 50	95>96	2630				2633	
50	K 12 50	95>	2630				2633	
50	Kb 50	94>	2630				2633	
50	Like 50 2T	09>	0580				0353	
50	Like 50 4T	09>	0580				0353	
50	Manboy	95>	1650					
50	Mxer - Euro2 - Mxu Sr	02>07			0091	2710		
50	New Dink 50	08>	0350				0353	
50	People 50	99>11	2710				0611	
50	People 50 Eu2	03>	2710				0400	
50	People 50 Eu2	08>	2710				0400	
50	People S 50	05>10	2710				0611	
50	People S 50 4T	06>13	2710				0400	
50	Sento 50	08>	0350				0353	
50	Sniper	93>	0170				0091	
50	Spacer 50	99>	0350				0353	
50	Super 8	09>12	2710				0400	
50	Super 9 50	00>01	2630				2633	
50	Super 9 50 Ac - Lc	02>	0350		2710			0353
50	Super 9 50 Sport Eu2	03>04			2710			
50	Tb 50	00>	2630				2633	
50	Top Boy 50 On / Off Road	96>	0350				0353	
50	Top Boy 50 Racer / Cross	01>	0350				0353	
50	Vitality 50	04>	0580				0583	
50	Yager 50	01>	0350				0353	
50	Yup 50	01>	2630				2633	
50	Yup 50	02>	0580				0583	
50	Zap	95>	1650					
50	Zk 50 Superfever	99>	2630				2633	



PASTIGLIE FRENO RMS - SINTER (RICERCA PER MARCA)











RMS - SINTER BRAKE PADS (SEARCH BY BRAND)

CC	MODELLO MODEL	ANNO YEAR								
			 ANTERIORE - FRONT		 POSTERIORE - REAR		 ANTERIORE FRONT	 POSTERIORE REAR		
			PASTIGLIA ORGANICA - ORGANIC				PASTIGLIA SINTERIZZATA SINTERED			
			 OMOLOGATA HOMOLOGATED	 NON OMOLOGATA NOT HOMOLOGATED	 GANASCE BRAKE SHOES	 OMOLOGATA HOMOLOGATED	 NON OMOLOGATA NOT HOMOLOGATED	 GANASCE BRAKE SHOES		
			22 510		22 512	22 510		22512	22 510	22 510
50	Zx 50 Fever	95>	2630				2633			
50	Zx 50 Super Fever	02>	2630				2633			
90	Manboy 90	96>	2630				2633			
90	Yup	95>	1650		0091					
100	Cobra 100 Racer	99>	0350				0353			
100	Kb 100	99>	2630				2633			
100	Top Boy 100	97>	0350				0353			
100	Top Boy 100 On / Off Road	99>	2630				2633			
125	Agility 125 4T	06>	0580				0611	0353		
125	Agility 125 4T Eu3	05>08	0580				0611	0353		
125	Agility 125 R 16	08>	2710				1200			
125	Agility 125 Rs	09>13	0580				0611	0353		
125	Agility 125 Rs R12 (4T) Naked +	10>	0580				0611			
125	B&w 125 Bet & Win	00>	0350		0350		0353	0353		
125	Dink 125	96>99	0350		0350		0353	0353		
125	Dink 125 Eu3	06>07	0350				0353			
125	Dink 125 I Eu3	06>07	0350				0353			
125	Downtown 125 i	09>	2640	0890	2760		2643	2763		
125	Downtown i	15	2670	0440	2760					
125	Grand Dink 125	02>	0350		0350		0353	0353		
125	Heroism	95>97	0240		0091					
125	Hipster 125	01>	0350				0353			
125	K-Xct i	12	2670	0440	2740					
125	Like 125	09>	0580		0350		0353	0353		
125	Movie 125	99>00	0580				0611	0353		
125	Movie 125 XL	01>	0350				0611	0353		
125	Mxer - Eu2 - Mxu Sr	02>07	0091		2710					
125	Mxer - Eu2 - Mxu Sr	02>07	0091		2710					
125	People 125	99>	2710				0611			
125	People 125 Eu2	03>04	2710							
125	People 125 Eu3	07>08	2710		2740		2743			
125	People One 125 i	13>	2710				0611	2743		
125	People Gti 125	10>	0870				0873			
125	People S 125	05>06	2710				0611			
125	People S 125 Dd	07>08	2710				2740		2743	
125	Pulsar 125	01>	0350				0353			
125	Spacer 125	99>	0350		0350		0353	0353		
125	Super 8 125	08>13	2710				0611			

PASTIGLIE FRENO RMS - SINTER (RICERCA PER MARCA)

RMS - SINTER BRAKE PADS (SEARCH BY BRAND)

















CC	MODELLO MODEL	ANNO YEAR	RMS YOUR BEST PARTNER				SINTER	
			 ANTERIORE - FRONT		 POSTERIORE - REAR		 ANTERIORE FRONT	 POSTERIORE REAR
			PASTIGLIA ORGANICA - ORGANIC				PASTIGLIA SINTERIZZATA SINTERED	
								
			OMOLOGATA HOMOLOGATED	NON OMOLOGATA NOT HOMOLOGATED	GANASCE BRAKE SHOES	OMOLOGATA HOMOLOGATED	NON OMOLOGATA NOT HOMOLOGATED	GANASCE BRAKE SHOES
22 510		22 512	22 510		22512	22 510	22 510	
125	Super 9 125	00>01	2630		2710		2633	
125	Superdink 125	10>	2640		2760		2643	2763
125	Vivio 125	00>03	0580			0611	0583	
125	Yager 125	01>	0350		0350		0353	0353
125	Zing 125	96>	0350				0353	
150	Agility 150 R 16	08>09	2710		0350			0353
150	B&w 150 Bet & Win	00>	0350		0350		0353	0353
150	Dink 150	97>	0350		0350		0353	0353
150	Dx 150 Custom	93>	2590				2593	
150	Freeway 150	95>	2630				2633	
150	Grand Dink 150	02>	0350		0350		0353	0353
150	Heroism	95>97	0240		9175			
150	Hipster 150	01>	0350				0353	
150	Movie 150 XL	01>09	0350			0611	0353	
150	People 150	99>	2710			0611		
150	People 150 Eu2	03>	2710					
150	People 150 Eu2	99>03	2710			0400		
150	Spacer 150	99>	0350		0350		0353	0353
150	Vivio 150	01>	0580			0400	0583	
150	Yager 150	01>	0350		0350	0611	0353	0353
150	Zing 150	99>	0350				0353	
200	Agility 200 i R 16	10>	2710		0350			0353
200	Dink 200 Euro 3 i	06>07	0350				0353	
200	Dink 200 i Eui3	06>07	0350				0353	
200	Downtown 200 i	10>	2640	0890	2760		2643	2763
200	Like 200 i	09>	0580		0350		0353	0353
200	People Gti 200	10>	0870				0873	
200	People S 200	04>07	2710			0611		
200	People S 200 i	07>	2710		2740			2743
200	Super 9 200	00>	2630		2710		2633	
200	Yager 200	04>	0350		0350		0353	0353
250	B&w 250 Bet & Win	00>	0350		0350		0353	0353
250	Gran Dink 250	01>	0500		0510			
250	People 250	03>05	0350		0870	0690	0353	0873
250	People S 250 (Pinza Dx)	06>	0350		2740		0353	2743
250	People S 250 (Pinza Sx)	06>	0580		2740		0583	2743
250	People S 250 I (Pinza Dx)	07>	0350		2740		0353	2743
250	People S 250 I (Pinza Sx)	07>	0580		2740		0583	2743



PASTIGLIE FRENO RMS - SINTER (RICERCA PER MARCA)

RMS - SINTER BRAKE PADS (SEARCH BY BRAND)

CC	MODELLO MODEL	ANNO YEAR	 YOUR BEST PARTNER							
			 ANTERIORE - FRONT		 POSTERIORE - REAR		 ANTERIORE FRONT	 POSTERIORE REAR		
			PASTIGLIA ORGANICA - ORGANIC				PASTIGLIA SINTERIZZATA SINTERED			
			 OMOLOGATA HOMOLOGATED	 NON OMOLOGATA NOT HOMOLOGATED	 GANASCE BRAKE SHOES	 OMOLOGATA HOMOLOGATED	 NON OMOLOGATA NOT HOMOLOGATED	 GANASCE BRAKE SHOES		
			22 510		22 512	22 510		22512	22 510	22 510
250	Venox 250	01>	0870			0873				
250	Xciting 250	04>	0870		0870	0873	0873			
250	Xciting 250	05>	2640	0890	2740	2643	2743			
250	Xciting 250 i	06>07	2640	0890	2740	2643	2743			
250	Yup 250	03>	0350		0350	0353	0353			
300	Agility Maxi i Abs	15	2670	0440						
300	Downtown 300 i	09>	2640	0890	2760	2643	2763			
300	People Gti 300	10>	0870			0873				
300	People S 300 i (Pinza Dx)	08>09	0350		2740	0353	2743			
300	People S 300 i (Pinza Sx)	08>09	0580		2740	0583	2743			
300	Xciting 300 i	08>	2640	0890		2643				
300	Xciting 300 i R	08>09	2640	0890	2740	2643	2743			
350	Downtown i Sport Touring Comfortable	15	2670	0440	2760					
400	Xciting 400 i	12>	2830		3140	2833	3143			
500	Xciting 500	04>	0870		0870	0873	0873			
500	Xciting 500	05>	2640	0890	3140	2643	3143			
500	Xciting 500 i	06>08	2640	0890	3140	2643	3143			
500	Xciting 500 i R	07>09	2640	0890	3140	2643	3143			
700	My Road 700	09>	2640	0890	3140	2643	3143			
KYMCO ATV										
50	Mxer 50	03>			2710					
50	Mxu 50	05>			2710					
50	Mxu 50 Sr	06>			2710					
125	Mxer 125	03>			2710					
150	Mxer 150	03>			2710					
150	Mxu 150	05>			2710					
250	Kxr 250	03>04	3070			3073				
250	Mxu 250	05>	3070		0500	3073				
LAVERDA										
50	Gaicho 50	92>	0010		0010	0013				
50	Or 50 Atlas	87>	0010		0010	0013				
125	125	>82	0010			0013				
125	125	-	3150			3153				
125	Gs 125 Lesmo	86>	0010		0010	0013				
125	Phoenix 125	01>			2710					
125	Phoenix	01	3260							
150	Phoenix 150	01>			2710					
150	Phoenix	01	3260							

PASTIGLIE FRENO RMS - SINTER (RICERCA PER MARCA)

RMS - SINTER BRAKE PADS (SEARCH BY BRAND)

















CC	MODELLO MODEL	ANNO YEAR	RMS YOUR BEST PARTNER				SINTER		
			ANTERIORE - FRONT		POSTERIORE - REAR		ANTERIORE FRONT	POSTERIORE REAR	
			PASTIGLIA ORGANICA - ORGANIC				PASTIGLIA SINTERIZZATA SINTERED		
			OMOLOGATA HOMOLOGATED	NON OMOLOGATA NOT HOMOLOGATED	GANASCE BRAKE SHOES	OMOLOGATA HOMOLOGATED	NON OMOLOGATA NOT HOMOLOGATED	GANASCE BRAKE SHOES	
22 510		22 512	22 510		22512	22 510	22 510		
200	Phoenix 200	01>	2710						
200	Phoenix	01	3260						
350	350	80>	0010		0010		0013		
500	Alpino 500	77>	0010		0010		0013		
500	Pf 500	77>	0010		0010		0013		
500	Rs 500	77>	0010		0010		0013		
500	Sfc 500	77>	3150		3150		3153	3153	
600	Or 600	86>	0010				0013		
650	Strada 650	96>	0520		0010		0523	0013	
668	Ghost - Diamante 668	96>	0520		0010		0523	0013	
750	750 S (All Models)	97>	0520		0010		0523	0013	
750	Cup 750	98>	0520		0010		0523	0013	
750	Diamante 750	97>	0520		0010		0523	0013	
750	Sf3 750	77>	3150		3150		3153	3153	
800	Tts 800	99>	0520		0490		0523	0493	
1000	1000 Jota	76>	0520		0010		0523	0013	
1000	1000 Jota	95>	0520				0523		
1000	3Ce 1000	74>	3150		3150		3153	3153	
1000	Jota 1000	95>			3150			3153	
1000	Rgs 1000	83>	3150		3150		3153	3153	
1000	Rgs 1000 Corsa	-	3150		3150		3153	3153	
1000	Rgs 1000 Jota	77>	3150		3150		3153	3153	
1000	Rgs 1000 Jota	86>	3150		3150		3153	3153	
1000	Sfc 1000	85>86	3150		3150		3153	3153	
1000	Sfc 1000	04>	2860		0490		2863	0493	
1000	Tga 1000 Executive	84>	3150		3150		3153	3153	
1200	Mirage 1200	78>	3150		3150		3153	3153	
1200	T.t. 1200	76>	3150		3150		3153	3153	
LEM									
50	Flash 50	94>						0061	
50	Ghibli 50	90>	0061					0061	
50	L2 - L3 50 Cross	03>	3220		3220		3223	3223	
65	Rx 65	05>	3220		3220		3223	3223	
LONCIN									
110	Lx 110 4	02>	0350					0353	
125	Lx 125	02>	0350					0353	
150	Lx 150 6	02>	0410					0413	



PASTIGLIE FRENO RMS - SINTER (RICERCA PER MARCA)

RMS - SINTER BRAKE PADS (SEARCH BY BRAND)

CC	MODELLO MODEL	ANNO YEAR								
			 ANTERIORE - FRONT		 POSTERIORE - REAR		 ANTERIORE FRONT	 POSTERIORE REAR		
			PASTIGLIA ORGANICA - ORGANIC				PASTIGLIA SINTERIZZATA SINTERED			
			 OMOLOGATA HOMOLOGATED	 NON OMOLOGATA NOT HOMOLOGATED	 GANASCE BRAKE SHOES	 OMOLOGATA HOMOLOGATED	 NON OMOLOGATA NOT HOMOLOGATED	 GANASCE BRAKE SHOES		
			22 510	22 512	22 510	22512	22 510	22 510		
MACAL										
50	Flash 50	99>	0190		0193					
50	Trophy 50 (Am5/6)	99>	0080		0083					
50	Trophy 50 H20 (Am5/6)	99>	0080		0083					
MACBOR										
50	Xc 50 510 Racing	04>	0650		0080	0083				
50	Xc 50 512 Pro	04>	0650							
50	Xc 50 512 R 6V	04>	0650		0080	0083				
50	Xc 50 512 Racing	04>	0650		0080	0083				
50	Xc 50 512 T	04>	0650							
MAICO										
50	C 1 50 Hard Enduro	99>	0040		0061					
50	Classic 50	99>			0061	0061				
50	Cruiser 50	99>	0040		0061					
50	R 1 50 Superbike	99>	0040		0061					
50	Thunderbike 50 i	99>	0040		0061					
50	Thunderbike 50 li	99>	0040		0061					
50	Traficjammer 50	99>			0061	0061				
50	X 1 50 Supercross	99>	0040		0061					
250	Cross 250	98>	0430		1330	1333				
250	Cross 250 Gm	84>	0010		0013					
250	Enduro 250	99>	0430		1330	1333				
250	Enduro 250 Gme	84>	0010		0013					
250	Motocross 250	99>	0430		1330	1333				
500	Cross 500	98>	0430		1330	1333				
500	Cross 500 Gm	84>	0010		0013					
500	Enduro 500	99>	0430		1330	1333				
500	Enduro 500 Gme	84>	0010		0013					
500	Motocross 500	99>	0430		1330	1333				
500	Supermotard 500	99>	0430		1330	1333				
MALAGUTI										
50	Centro 50	>92			0091					
50	Centro 50 4T	08>	0040		0560					
50	Centro 50 SI	93>	0070		0091					
50	Centro SI 50 4T	10>	0040		0560					
50	Chopper 25 - 40 - 80 - Fifty	>82			0191					
50	Ciak 50	99>	0190		0091	0193				
50	Ciak 50 Master	04>05	0190		0091	0193				
50	Ciak 50 Master 4T	05>06	0190		0560	0193				

PASTIGLIE FRENO RMS - SINTER (RICERCA PER MARCA)

RMS - SINTER BRAKE PADS (SEARCH BY BRAND)

















CC	MODELLO MODEL	ANNO YEAR	RMS YOUR BEST PARTNER				SINTER	
			ANTERIORE - FRONT		POSTERIORE - REAR		ANTERIORE FRONT	POSTERIORE REAR
			PASTIGLIA ORGANICA - ORGANIC				PASTIGLIA SINTERIZZATA SINTERED	
			OMOLOGATA HOMOLOGATED	NON OMOLOGATA NOT HOMOLOGATED	GANASCE BRAKE SHOES	OMOLOGATA HOMOLOGATED	NON OMOLOGATA NOT HOMOLOGATED	GANASCE BRAKE SHOES
22 510		22 512	22 510		22512	22 510	22 510	
50	Ciak 50 Master Eu2	06>	0190		0091		0193	
50	Ciak 50 Mono Eu2,3	03>	0190		0091		0193	
50	Ciak 50 Td	00>01	0190		0190	0193	0193	
50	Ciak 50 Twin Disk	02>	0190		0190	0193	0193	
50	Ciclomotori 50 All Models	>83	0030		0191			
50	Cr1 50 Crosser	95>	0030					
50	Cr1 50 Crosser	97>	0190				0193	
50	Crw 50 Enduro	03>	0080		0080	0083	0083	
50	Crw 50 Motard	03>	0360		2810	0363		
50	Dune 50 Enduro	87>	0030		0030			
50	F 10 50	92>93	0130		0091			
50	F 10 50 Ac	08>	0190		0061		0193	
50	F 10 50 Ac Eco	09>10	0040		0061			
50	F 10 50 All Models	94>	0190		0091		0193	
50	F 10 50 Timermachine	02>	0190		0091		0193	
50	F 10 50 Wap	02>	0190		0091		0193	
50	F 12 50 Mechatronic	03>	0190		0190	0193	0193	
50	F 12 50 Phantom	94>	0030		0091			
50	F 12 50 Phantom Digit	02>	0190		0190	0193	0193	
50	F 12 50 Phantom Liquid Cooled	95>97	0030		0091			
50	F 12 50 Phantom Twin Disk	98>	0070		0190		0193	
50	F 12 50 Racing Life	03>	0190		0190	0193	0193	
50	F 12 50 Tyre Track	03>	0190		0190	0193	0193	
50	F 12 R 50 Phantom Ac	07>08	0190		0061		0193	
50	F 12 R 50 Phantom Ac	09>10	0040		0061			
50	F 12 R 50 Phantom Lc	07>10	0040		0190		0193	
50	F 15 50 Firefox	96>97	0070		0091			
50	F 15 50 Firefox Twin Disk	98>	0070		0190		0193	
50	Fifty 50 Full All Models	83>	0030					
50	Fifty 50 Top	85>	0030					
50	Lx 50 Sport	>82			0191			
50	Mdx Gold 50 Enduro	87>	0070					
50	Mlx 50 Enduro	87>	0070					
50	Mr4 50 Enduro	87>	0030		0030			
50	Nkd 50	04>	0360		0080	0363	0083	
50	Rcw 50 Ronco	>82			0191			
50	Rcx-W 50 Enduro	83>	0030					
50	Rgt 50 Sport	85>	0030					



PASTIGLIE FRENO RMS - SINTER (RICERCA PER MARCA)

RMS - SINTER BRAKE PADS (SEARCH BY BRAND)

CC	MODELLO MODEL	ANNO YEAR								
			 ANTERIORE - FRONT		 POSTERIORE - REAR		 ANTERIORE FRONT	 POSTERIORE REAR		
			PASTIGLIA ORGANICA - ORGANIC				PASTIGLIA SINTERIZZATA SINTERED			
			 OMOLOGATA HOMOLOGATED	 NON OMOLOGATA NOT HOMOLOGATED	 GANASCE BRAKE SHOES	 OMOLOGATA HOMOLOGATED	 NON OMOLOGATA NOT HOMOLOGATED	 GANASCE BRAKE SHOES		
			22 510	22 512	22 510	22512	22 510	22 510		
50	Rgt 50 Strada	83>	0030							
50	Rst 50 Sport Tutti I Tipi	87>	0030		0030					
50	Sahib 50 Enduro	83>	0030							
50	Va 50 Olympique	>82				0191				
50	Xsm 50	03>	0360		2810		0363			
50	Xsm 50 Power-Up	07>08			2730	1430				
50	Xtm 50	03>	0080		2810		0083			
50	Xtm 50 Power-Up	07>08			2730	1430				
50	Yesterday 50	98>	0190				0091	0193		
80	Chopper 80	>82					0191			
100	Ciak 100	99>01	0190		0190		0193	0193		
100	F 12 100 Phantom	99>	0190		0190		0193	0193		
125	Blog 125 ie	09>10	0580		1200		0583			
125	Centro 125 ie	08>09	0580		2730	1430	0583			
125	Centro 125 SL ie	09>10	0580		2730	1430	0583			
125	Ciak 125	00>01	2020				0400			
125	Ciak 125 Master	04>	2020				0400			
125	Ciak 125 Master Eui3	06>	2020				0400			
125	Ciak 125 Restyling Eui2	03>	2020				0400			
125	F 12 125 Max	02>	0360		0310		0363	0313		
125	F 18 125 Warrior	01>	2020		0310			0313		
125	Madison 125	99>02	0360		0310		0363	0313		
125	Madison 3 125	06>09	0360		1500		0363	1503		
125	Madison R 125 Restyling	02>	0360		0310		0363	0313		
125	Madison R 125 Restyling Eui2	03>04	0360		0310		0363	0313		
125	Phantom Max 125	03>	0360		0310		0363	0313		
125	Runner 125 Rally	87>	0060				0063			
125	Runner 125 Ypvs	86>	0060				0063			
125	X3m 125 Enduro	08>			2730	1430				
125	X3m 125 Enduro Motore Bra	08>			2730	1430				
125	X3m 125 Motard	08>			2730	1430				
150	Ciak 150	00>02	2020				0400			
150	Ciak 150 Master	03>	2020				0400			
150	Ciak 150 Restyling Eui2	04>	2020				0400			
150	F 18 150 Warrior	01>	2020		0310			0313		
150	Madison T 150	99>01	0360		0310		0363	0313		
160	Blog 160 ie	09>10	0580		1200		0583			

PASTIGLIE FRENO RMS - SINTER (RICERCA PER MARCA)

RMS - SINTER BRAKE PADS (SEARCH BY BRAND)















CC	MODELLO MODEL	ANNO YEAR	RMS YOUR BEST PARTNER				SINTER	
			ANTERIORE - FRONT		POSTERIORE - REAR		ANTERIORE FRONT	POSTERIORE REAR
			PASTIGLIA ORGANICA - ORGANIC				PASTIGLIA SINTERIZZATA SINTERED	
			OMOLOGATA HOMOLOGATED	NON OMOLOGATA NOT HOMOLOGATED	GANASCE BRAKE SHOES	OMOLOGATA HOMOLOGATED	NON OMOLOGATA NOT HOMOLOGATED	GANASCE BRAKE SHOES
22 510		22 512	22 510		22512	22 510	22 510	
160	Centro 160 ie	08>09	0580		2730	1430	0583	
160	Centro 160 SL ie	09>10	0580		2730	1430	0583	
180	Madison R 180	01>02	0360		0310		0363	0313
200	Ciak 200 Master Eu2	06>	2020		0400			
200	F 12 200 Max	02>	0360		0310		0363	0313
200	Madison 200 All Models	99>	0360		0310		0363	0313
200	Madison S 200 Restyling	02>	0360		0310		0363	0313
200	Madison S 200 Restyling Eu2	03>	0360		0310		0363	0313
200	Phantom Max 200	03>	0360		0310		0363	0313
250	Madison 250	99>	2670	0440	0310		2673	0313
250	Madison 3 250	06>09	0360		1500		0363	1503
250	Madison Rs 250 Restyling	04>	0360		0310		0363	0313
250	Password 250	05>06	0360		0310		0363	0313
250	Password 250 Eu3	07>08	0360		0310		0363	0313
250	Phantom Max 250	04>	0360		0310		0363	0313
400	Madison 400	02>	2670	0440	0310		2673	0313
400	Madison 400 Restyling	03>	2670	0440	0310		2673	0313
500	Gt 500 Spidermax	04>05	0060		0490		0063	0493
500	Gt 500 Spidermax Eu3	06>07	0060		0490		0063	0493
500	Rs 500 Spidermax	08>09	0060		0490		0063	0493
MALANCA								
80	E2 C 80 Cs	-	0010		0010		0013	0013
125	Gti 125	-	0010		0010		0013	0013
125	Mark 125 Enduro	-	0010		0013			
MBK								
50	Active 50	90>	0051					
50	Booster 50	>94	0051		0580			
50	Booster 50	>94	0051		0051			
50	Booster 50 Next Generation	96>	3210		0061			
50	Booster 50 R	94>	3210		0051			
50	Booster 50 Spirit	96>	3210		0051			
50	Booster 50 Track	96>	3210		0051			
50	Cr Z 50 Target	91>95	0180		0061			
50	Cs 50 Mach G	02>	0190		0061		0193	
50	Dodo 50	00>	0190		0193			
50	Evolis 50	92>	3210		0061			
50	Fizz 50	94>	3210		0051			
50	Flipper 50	98>	0190		0051		0193	



PASTIGLIE FRENO RMS - SINTER (RICERCA PER MARCA)

RMS - SINTER BRAKE PADS (SEARCH BY BRAND)

CC	MODELLO MODEL	ANNO YEAR						
			 ANTERIORE - FRONT		 POSTERIORE - REAR		 ANTERIORE FRONT	 POSTERIORE REAR
			PASTIGLIA ORGANICA - ORGANIC				PASTIGLIA SINTERIZZATA SINTERED	
								
			OMOLOGATA HOMOLOGATED	NON OMOLOGATA NOT HOMOLOGATED	GANASCE BRAKE SHOES	OMOLOGATA HOMOLOGATED	NON OMOLOGATA NOT HOMOLOGATED	GANASCE BRAKE SHOES
50	Forte 50	95>	3210				0051	
50	Mach 50	02>	3210					
50	Nitro 50	97>	3210		0280			
50	Ovetto 50	97>	3210				0061	
50	Rocket 50	96>	0190				0061	0193
50	Sorriso 50	92>		0061			0061	
50	Stun't 50	00>	0190				0061	0193
50	X-Limit 50	04>	0080		0080			0083 0083
50	X-Limit 50	98>	0070				0061	
50	X-Power 50	04>	0360		0080			0363 0083
75	Active 75	90>		0051				
80	Active 80	90>		0051				
80	Evolis 80	94>	3210				0061	
100	Yn R 100 Ovetto	00>	3210				0451	
100	Yq 100 Nitro	00>	3210				0451	
100	Yw 100 Booster	99>	0180					
150	Xc Vertex	97>	2730	1430			0451	
125	Xc 125 Flame	98>	2730	1430			0061	
125	Xc 125 Flame R	98>	2730	1430			0061	
125	Xn 125 Doodo	00>01	3210				0451	
125	Xq 125 Thunder	01>	0430		0490			0493
125	Yp 125 Skyliner	98>01	0430				0451	
125	Yp 125 Skyliner	02>	0430		0490			0493
150	Xn 150 Doodo	01>	3210					
150	Xq 150 Thunder	01>	0430		0490			0493
150	Yp 150 Skyliner	02>	0430		0490			0493
150	Yp 150 Skyliner	>01	0430					
180	Yp 180 Skyliner	04>	0430		0490			0493
250	Yp 250 Skyliner	00>	0410		2660		0413	2663
300	Kilibre 300	03>	0430		0430			
400	Yp 400 Skyliner	04>	0410		2660		0413	2663
MEGELLI								
125	125 M / R / S	08>			0660			0663
METRAKIT								
50	Big Foot 50	08>			3220		3223	
50	Fun 50 2 Stroke	05>	0080		0650		0083	
50	Fun 50 4 Stroke	05>	0080		0650		0083	
50	Mini Gp 50	03>	0080		0650		0083	

PASTIGLIE FRENO RMS - SINTER (RICERCA PER MARCA)

RMS - SINTER BRAKE PADS (SEARCH BY BRAND)

















CC	MODELLO MODEL	ANNO YEAR	RMS YOUR BEST PARTNER				SINTER	
			ANTERIORE - FRONT		POSTERIORE - REAR		ANTERIORE FRONT	POSTERIORE REAR
			PASTIGLIA ORGANICA - ORGANIC				PASTIGLIA SINTERIZZATA SINTERED	
			OMOLOGATA HOMOLOGATED	NON OMOLOGATA NOT HOMOLOGATED	GANASCE BRAKE SHOES	OMOLOGATA HOMOLOGATED	NON OMOLOGATA NOT HOMOLOGATED	GANASCE BRAKE SHOES
22 510		22 512	22 510		22512	22 510	22 510	
50	Mini Gp 50 XL	05>	0490		0650		0493	
50	Mongoose 50	08>			3220		3223	
50	Pro 50	08>			3220		3223	
80	Mini Gp 80 XL Pro	04>	0640		0650			
80	XL 08 80	08>			0650			
110	Srm 110 4T	07>			3220		3223	
125	Pre Gp 125	07>	3160		0650		3163	
MINICAR								
500	Microcar 500	-	0540					
505	Grecav 505 Eike	-	0540					
MODENAS								
125	Kriss 115	99>	1070				1073	
MONDIAL								
1000	Evo 1000	04>	2860		0490		2863 0493	
1000	Piega 1000	03>	2860		0490		2863 0493	
1000	Rz 1000 Nuda	04>	2860		0490		2863 0493	
1000	Starfighter 1000	04>	2860		0490		2863 0493	
MONTESA								
50	Mks 50	87>	0030					
250	Cota 250 4Rt	05>	0640		0650			
260	Evasion 260	94>	0080		0080		0083 0083	
304	Cota 304	87>	0030					
304	Cota 304	88>	0080		0080		0083 0083	
307	Cota 307	89>	0080		0080		0083 0083	
309	Cota 309	89>	0080		0010		0083 0013	
310	Cota 310	89>	0080		0010		0083 0013	
311	Cota 311	92>	0080		0010		0083 0013	
314	Cota 314 R	94>	0080		0010		0083 0013	
315	Cota 315	97>	0080		0080		0083 0083	
315	Cota 315 (360)	01>04	0640		0650			
335	Cota 335	87>91	0080		0080		0083 0083	
335	Cota 335	89>	0080		0080		0083 0083	
360	H7-S 360 Enduro	86>	0030					
360	M7 360 Enduro	86>	0080				0083	
	All Models Trial	01>	0640		0650			
MOTO GUZZI								
50	Chiu' 50	74>76			0191		0191	
50	Dingo 50 3 V	75>76			0191		0191	



PASTIGLIE FRENO RMS - SINTER (RICERCA PER MARCA)















RMS - SINTER BRAKE PADS (SEARCH BY BRAND)

CC	MODELLO MODEL	ANNO YEAR								
			 ANTERIORE - FRONT		 POSTERIORE - REAR		 ANTERIORE FRONT	 POSTERIORE REAR		
			PASTIGLIA ORGANICA - ORGANIC				PASTIGLIA SINTERIZZATA SINTERED			
			 OMOLOGATA HOMOLOGATED	 NON OMOLOGATA NOT HOMOLOGATED	 GANASCE BRAKE SHOES	 OMOLOGATA HOMOLOGATED	 NON OMOLOGATA NOT HOMOLOGATED	 GANASCE BRAKE SHOES		
			22 510		22 512	22 510		22512	22 510	22 510
50	Dingo 50 3M	66>74			0191		0191			
50	Dingo 50 M	69>73			0191		0191			
50	Dingo 50 Mm	75>76			0191		0191			
50	Magnum 50	75>76			0191		0191			
50	Trotter 50	66>70			0191		0191			
50	Trotter 50 Mark M - V	71>73			0191		0191			
50	Trotter 50 Special M - V	71>73			0191		0191			
50	Trotter 50 Super	66>70			0191		0191			
125	2C 125 4T	79>	0010					0013		
125	Tt 125	85>	0010					0013		
250	Ts 250	76>82	0010			0010		0013	0013	
350	Gts 350	74>79	0010			0010		0013	0013	
350	Nevada 350	93>	0010			0010		0013	0013	
350	Ntx 350	90>				3150			3153	
350	Ntx 350	87>	0010			0010		0013	0013	
350	Ntx 350	90>	0010					0013		
350	V 35 350 Gt	90>	3150					3153		
350	V 35 350	77>	0010			0010		0013	0013	
350	V 35 350 C	82>	0010			0010		0013	0013	
350	V 35 350 Florida	87>	0010			0010		0013	0013	
350	V 35 350 Gt	90>				0010			0013	
350	V 35 350 Imola	70>83	0010			0010		0013 0013	0013 0013	
350	V 35 350 Imola li	84>	0010			0010		0013	0013	
350	V 35 350 Tt Enduro	84>	0010			0010		0013	0013	
400	Gts 400	74>79	0010			0010		0013	0013	
500	V 50 500	77>80	0010			0010		0013	0013	
500	V 50 500 C	82>	0010			0010		0013	0013	
500	V 50 500 li	80>	0010			0010		0013	0013	
500	V 50 500 Monza	80>83	0010			0010		0013	0013	
500	V 50 500 Monza li	84>	0010			0010		0013	0013	
650	Gt 650 Sessantacinque	89>	0010			0010		0013	0013	
650	Nevada 650	92>96	0010			0010		0013	0013	
650	Nevada 650 Club / Base	97>02	0010			0010		0013	0013	
650	Ntx 650	90>				3150			3153	
650	Ntx 650	90>	0010					0013		
650	V 65 650 Gt	90>	3150					3153		
650	V 65 650	81>83	0010			0010		0013	0013	
650	V 65 650 Florida	87>	0010			0010		0013	0013	

PASTIGLIE FRENO RMS - SINTER (RICERCA PER MARCA)

RMS - SINTER BRAKE PADS (SEARCH BY BRAND)

















CC	MODELLO MODEL	ANNO YEAR								
			 ANTERIORE - FRONT		 POSTERIORE - REAR		 ANTERIORE FRONT	 POSTERIORE REAR		
			PASTIGLIA ORGANICA - ORGANIC				PASTIGLIA SINTERIZZATA SINTERED			
			 OMOLOGATA HOMOLOGATED	 NON OMOLOGATA NOT HOMOLOGATED	 GANASCE BRAKE SHOES	 OMOLOGATA HOMOLOGATED	 NON OMOLOGATA NOT HOMOLOGATED	 GANASCE BRAKE SHOES		
			22 510		22 512	22 510		22512	22 510	22 510
650	V 65 650 Gt	90>					0010		0013	
650	V 65 650 li Enduro	84>	0010				0010	0013	0013	
650	V 65 650 Lario	84>	0010				0010	0013	0013	
650	V 65 650 Sp Chopper	81>	0010				0010	0013	0013	
650	Vt 650 Tt Baja	86>					0010		0013	
750	Breva 750	03>06	1100				0490	1103	0493	
750	Griso 750	04>	2860				0490	2863	0493	
750	Ippogrifo	97>	0520					0523		
750	Nevada 750 Club	03>	1100				0490	1103	0493	
750	Ntx 750	90>					3150		3153	
750	S 750	74>75	3150					3153		
750	S3 750	75>76	3150				3150	3153	3153	
850	California 850 T3	75>80	3150				3150	3153	3153	
850	Le Mans 850	76>	3150				3150	3153	3153	
850	T 850	74>75	3150					3153		
850	T 5 850	84>	3150				3150	3153	3153	
850	T3 850	75>	3150				3150	3153	3153	
850	T4 850	80>	3150				3150	3153	3153	
1000	California 1000 li	81>	3150				3150	3153	3153	
1000	California 1000 li C	91>	3150				3150	3153	3153	
1000	California 1000 Ev	99>	0520				1010	0523	1013	
1000	Daytona 1000	91>					3150		3153	
1000	Daytona 1000	91>	0520					0523		
1000	Gt V 1000	91>	3150				3150	3153	3153	
1000	Le Mans 1000	84>	3150				3150	3153	3153	
1000	Le Mans - V 1000	90>	3150				3150	3153	3153	
1000	Sp 1000	78>83	3150					3153		
1000	Sp 1000 li	84>	3150				3150	3153	3153	
1000	Sp lii 1000	91>	3150				3150	3153	3153	
1000	V 1000 1000 G5	78>	3150				3150	3153	3153	
1000	V 1000 1000 I Convert	75>	3150				3150	3153	3153	
1100	Breva 1100	04>	1100				0490	1103	0493	
1100	Breva 1100	05>	1100				1010	1103	1013	
1100	California 1100	94>96	3150				3150	3153	3153	
1100	California 1100	01>	1100				1010	1103	1013	
1100	California 1100 Classic Touring	06>	1100				1010	1103	1013	
1100	California 1100 Ev	97>00	0520				1010	0523	1013	
1100	California 1100 Ev	01>05	1100				0010	1103	0013	



PASTIGLIE FRENO RMS - SINTER (RICERCA PER MARCA)

RMS - SINTER BRAKE PADS (SEARCH BY BRAND)

CC	MODELLO MODEL	ANNO YEAR								
			 ANTERIORE - FRONT		 POSTERIORE - REAR		 ANTERIORE FRONT	 POSTERIORE REAR		
			PASTIGLIA ORGANICA - ORGANIC				PASTIGLIA SINTERIZZATA SINTERED			
			 OMOLOGATA HOMOLOGATED	 NON OMOLOGATA NOT HOMOLOGATED	 GANASCE BRAKE SHOES	 OMOLOGATA HOMOLOGATED	 NON OMOLOGATA NOT HOMOLOGATED	 GANASCE BRAKE SHOES		
			22 510		22 512	22 510		22512	22 510	22 510
1100	California 1100 Ev	06>	1100		1010		1103	1013		
1100	California 1100 Ev Touring	04>	1100		1010		1103	1013		
1100	California 1100 Jackal	00>	0520		1010		0523	1013		
1100	California 1100 Jackal	01>	1100		1010		1103	1013		
1100	California 1100 Jackal Basic	00>	0520		1010		0523	1013		
1100	California 1100 Jackal Basic	01>	1100		1010		1103	1013		
1100	California 1100 Special	99>00	0520		1010		0523	1013		
1100	California 1100 Special	01>	1100		1010		1103	1013		
1100	Griso 1100	05>	1100		0430		1103			
1100	Quota 1100	99>	1010		1010		1013	1013		
1100	Sport 1100	01>			3150			3153		
1100	Sport 1100	94>00	0520		0010		0523	0013		
1100	Sport 1100	01>	1100				1103			
1100	V 11 1100 Le Mans	01>	1100		0010		1103	0013		
1100	V 11 1100 Scura	02>	1100		0010		1103	0013		
1100	V 11 1100 Sport	97>00	0520		0010		0523	0013		
1100	V 11 1100 Sport	01>	1100		0010		1103	0013		
1100	V 11 1100 Sport Naked	01>	1100		0010		1103	0013		
1100	V 11 1100 Sport Rosso Mandell	01>	1100		0010		1103	0013		
1100	V 11 1100 Sport Scura	02>	1100		0010		1103	0013		
1200	Griso 1200 8V	05>	1100		0430		1103			
1200	Mgs-01 1200 Corsa	05>	2860		0490		2863	0493		
1200	Norge 1200	06>	1100		0430		1103			
1200	Norge 1200 Abs	06>	1100		0430		1103			
1200	Sport 1200	06>	1100		0430		1103			
1200	Sport 1200 Abs	06>	1100		0430		1103			
1200	Stelvio 1200	08>	1100		0430		1103			
MOTO MORINI										
125	Blues 125	93>	0060		0010		0063	0013		
350	Cogauro 350	90>			0010			0013		
350	Dart 350	88>89			0010			0013		
350	Dart 350	90>			0010			0013		
350	Exalibur Rlx 350	90>			0010			0013		
350	Excalibur 350	86>89	0060				0063			
350	Kanguro 350	87>	0060		0010		0063	0013		
350	New York 350	89>			0010			0013		
350	Ws 350 Pro Action	93>			0010			0013		
400	Dart 400	90>			0010			0013		

PASTIGLIE FRENO RMS - SINTER (RICERCA PER MARCA)

RMS - SINTER BRAKE PADS (SEARCH BY BRAND)

















CC	MODELLO MODEL	ANNO YEAR								
			 ANTERIORE - FRONT		 POSTERIORE - REAR		 ANTERIORE FRONT	 POSTERIORE REAR		
			PASTIGLIA ORGANICA - ORGANIC				PASTIGLIA SINTERIZZATA SINTERED			
			 OMOLOGATA HOMOLOGATED	 NON OMOLOGATA NOT HOMOLOGATED	 GANASCE BRAKE SHOES	 OMOLOGATA HOMOLOGATED	 NON OMOLOGATA NOT HOMOLOGATED	 GANASCE BRAKE SHOES		
			22 510	22 512	22 510	22512	22 510	22 510		
501	Camel 501	87>	0060		0010			0063	0013	
501	Camel 501	>86	0010							
501	Coguardo 501	89>			0010				0013	
501	Excalibur 501	86>86	0060					0063		
501	Excalibur 501	87>88	0060		0010			0063	0013	
501	Excalibur 501	89>			0010				0013	
501	New York 501	89>			0010				0013	
950	9 1/2 950	06>	1100		0490			1103	0493	
1200	Corsaro 1200	06>	1100		0490			1103	0493	
1200	Gran Passo 1200	08>	1010		0430			1013		
1200	Granferro 1200	10>	2860		0430			2863		
1200	Gt 1200	10>	1010		0430			1013		
1200	Scrambler 1200	09>	1010		0430			1013		
1200	Sport 1200	08>	1100		0490			1103	0493	
MOTOR UNION										
125	Jc 125 2B Deer	98>	2630					2633		
250	Hk 250 Haoke	97>	1070					1073		
MOTORHISPANIA										
50	Mx 50 Furia	00>	0080		0080			0083	0083	
50	Rx 50 Racing	00>	0060		0080			0063	0083	
50	Rx 50 Racing	04>05	0740		0080				0083	
50	Ryz 50 Cross	04>05	0080		0080			0083	0083	
50	Ryz 50 Enduro	05>	0080		0080			0083	0083	
50	Ryz 50 Supermotard	04>05	0740		0080				0083	
125	Ryz 125 Arena Enduro	05>	0080		0080			0083	0083	
MOTRON										
50	Compact 50 Racing Es	89>92	0030							
50	Compact 50 Wf	88>92	0030							
50	Gl 4 50 Flash Id	89>93	0030							
50	Kcv 50	-	1440							
50	Rz 1 50 Es	89>94	0030							
50	Spike 50	98>	0190					0193		
50	Sting 50	95>	0030							
50	Syncro 50	98>	0190					0193		
50	Thunder 50	95>	0190					0193		
50	Xle 50	88>93	0030		0010				0013	
MV AGUSTA										
910	Brutale 910 R	05>06	2860					2863		



PASTIGLIE FRENO RMS - SINTER (RICERCA PER MARCA)

RMS - SINTER BRAKE PADS (SEARCH BY BRAND)

CC	MODELLO MODEL	ANNO YEAR	 YOUR BEST PARTNER							
			 ANTERIORE - FRONT		 POSTERIORE - REAR		 ANTERIORE FRONT	 POSTERIORE REAR		
			PASTIGLIA ORGANICA - ORGANIC				PASTIGLIA SINTERIZZATA SINTERED			
			 OMOLOGATA HOMOLOGATED	 NON OMOLOGATA NOT HOMOLOGATED	 GANASCE BRAKE SHOES	 OMOLOGATA HOMOLOGATED	 NON OMOLOGATA NOT HOMOLOGATED	 GANASCE BRAKE SHOES		
			22 510		22 512	22 510		22512	22 510	22 510
989	Brutale 989 R	08>	1100				1103			
1000	F4 1000 R	06>	2860				2863			
1000	F4 1000 R 312	06>	2860				2863			
1000	F4 1000 Senna	06>	2860				2863			
1078	Brutale 1078 Rr	08>					2923			
1078	F4 1078 Rr 312 / Cc	08>					2923			
1090	Brutale 1090 Rr	10>					2923			
800	Rivale 800	13>					3193			
MZ										
50	Moskito 50	99>	0180							
50	Moskito 50 Sx	00>	0040							
125	Etz 125	82>	3150				3153			
125	Etz 125	85>	3150				3153			
125	Mantizz S 125	07>	2590				2593			
125	Moskito 125	99>	0180							
125	Roadstar 125	-	3150				3153			
125	Sm 125	02>	0580				0583			
125	Sportstar 125	93>	3150				3153			
125	Sx 125	02>	0580				0583			
150	Etz 150	82>	3150				3153			
250	Etz 250	82>	3150				3153			
251	Sportstar 251	96>	3150		3150		3153	3153		
300	Etz 300	88>	3150				3153			
301	Etz 301	90>	3150				3153			
301	Sportstar 301	96>	3150		3150		3153	3153		
500	Saxon 500 All Models	92>	3150		3150		3153	3153		
500	Silver 500 Star Classic	93>	3150		3150		3153	3153		
660	Skorpion 660 Sport	95>99	0520				0523			
660	Skorpion 660 Tour	95>99	0520				0523			
660	Skorpion 660 Traveller	99>	0520				0523			
1000	S 1000 (Muz)	01>02	1100		0410		1103	0413		
1000	S 1000 (Muz)	03>	3030				3033	3113		
1000	Sf 1000 (Muz)	05>	3030				3033	3113		
1000	Sfx 1000 (Muz)	07>	3030				3033	3113		
1000	Sn 1000 (Muz)	05>	3030				3033	3113		
1000	St 1000 (Muz)	06>	3030				3033	3113		
NORTON										
	Commander	90>	3150		3150		3153	3153		

PASTIGLIE FRENO RMS - SINTER (RICERCA PER MARCA)

RMS - SINTER BRAKE PADS (SEARCH BY BRAND)

















CC	MODELLO MODEL	ANNO YEAR	RMS YOUR BEST PARTNER				SINTER			
			ANTERIORE - FRONT		POSTERIORE - REAR		ANTERIORE FRONT	POSTERIORE REAR		
			PASTIGLIA ORGANICA - ORGANIC				PASTIGLIA SINTERIZZATA SINTERED			
			OMOLOGATA HOMOLOGATED	NON OMOLOGATA NOT HOMOLOGATED	GANASCE BRAKE SHOES	OMOLOGATA HOMOLOGATED	NON OMOLOGATA NOT HOMOLOGATED	GANASCE BRAKE SHOES		
22 510		22 512	22 510		22512	22 510	22 510			
	F 1 Formula	89>	0520		0010		0523	0013		
	Formula 1 Sport	92>	0520		0010		0523	0013		
	Interpol 2 (Rotary)	83>	3150		3150		3153	3153		
	Tt	92>	0520		0010		0523	0013		
	Wankel Classic 2 (Rotary)	88>	3150		3150		3153	3153		
OSSA										
280	280 I	10>	0640		0650					
PETERSON										
50	Hurricane 50	95>	0180		0040					
50	Sr 50 Racing	95>	0180		0040					
80	Hurricane 80	95>	0180		0040					
80	Sr 80 Racing	95>	0180		0040					
PEUGEOT										
50	Asv 50 (Forcella Telescopica)	93>	0130			0091				
50	Blaster 50	09>	0080				0083			
50	Blaster 50 Rs 12	09>	0080				0083			
50	Buxi 50	94>	0190			0091	0193			
50	Buxi Rs 50	94>	0040							
50	Elyseo 50	98>	0080				0083			
50	Elystar 50	03>05	0080		2810		0083			
50	Jet C-Tech 50	09>	0080		0080		0083	0083		
50	Jet Force 50	03>	0080		0080		0083	0083		
50	Kisbee 50	10>	0080				0083			
50	Looxor 50	01>05	0080				0083			
50	Looxor 50	06>	0080		0080		0083	0083		
50	Ludix 50	04>	0080				0083			
50	New Vivacity 50	10>	1440							
50	Nk 7 50	09>12	3160				3163			
50	Speedake 50	95>	0190			0091	0193			
50	Speedfight 50 (Raff. Acqua Pinze Ajp)	98>	0080		0080		0083	0083		
50	Speedfight 50 M (Pinza Ajp)	97>98	0080				0083			
50	Speedfight 50 M (Pinza Heng-Tong)	97>	0040							
50	Squab 50	95>95	0130			0091				
50	Squab 50	96>	0040							
50	Sv 50 Geo (All Models)	93>	2630				2633			
50	Sv 50 T (Forcella Telescopica)	93>	0130			0091				
50	Tkr 50 Furious	05>	0080				0083			



PASTIGLIE FRENO RMS - SINTER (RICERCA PER MARCA)

RMS - SINTER BRAKE PADS (SEARCH BY BRAND)

CC	MODELLO MODEL	ANNO YEAR								
			 ANTERIORE - FRONT		 POSTERIORE - REAR		 ANTERIORE FRONT	 POSTERIORE REAR		
			PASTIGLIA ORGANICA - ORGANIC				PASTIGLIA SINTERIZZATA SINTERED			
			 OMOLOGATA HOMOLOGATED	 NON OMOLOGATA NOT HOMOLOGATED	 GANASCE BRAKE SHOES	 OMOLOGATA HOMOLOGATED	 NON OMOLOGATA NOT HOMOLOGATED	 GANASCE BRAKE SHOES		
			22 510		22 512	22 510		22512	22 510	22 510
50	Tkr 50 Wrc	05>	0080				0083			
50	Trekker 50 Road	97>	0040							
50	V-Click 50	08>	0180							
50	Vivacity 50 (Forcelle Paioli)	98>	0080				0083			
50	Vivacity 50 (Pinza Heng tong)	05>	0040							
50	X Fight 50 (Raffreddamento Liquido)	00>	0080		0080		0083	0083		
50	X Fight 50 M	00>	0080				0083			
50	Xp 6 50 Enduro	06>	0080		0080		0083	0083		
50	Xp 6 50 Supermotard	06>	0080		0080		0083	0083		
50	Xp 6 50 Trail	04>	0080		0080		0083	0083		
50	Xp S6 50 Enduro	04>	0080		0080		0083	0083		
50	Xp S6 50 Supermotard	03>	0360		2810		0363			
50	Xr 6 50 Race Spec	02>07	0740		0080			0083		
50	Xr 7 50	08>			3160			3163		
50	Zenith 50	92>	0170		0091					
50	Zenith 50	96>	0080				0083			
80	Sv Geo	91>92	0170							
100	Elyseo 100	02>	0080		0080		0083	0083		
100	Elyseo 100	98>01	0080				0083			
100	Looxor 100	02>	0080		0080		0083	0083		
100	Speedfight 100	97>	0080		0080		0083	0083		
100	Trekker 100	98>	0080				0083			
100	Vivacity 100 (Pinza Heng tong)	05>	0040							
100	Vivacity 100 .	98>	0080				0083			
100	X Fight 100 (Raffreddamento Liquido)	00>	0080		0080		0083	0083		
100	X Fight 100 M	00>	0080				0083			
125	Elyseo 125	00>	0360		2810		0363			
125	Elyseo 125	98>	0080		0400		0083			
125	Elystar 125	02>	0360		2810		0363			
125	Geopolis 125	06>	0360		2620		0363	2623		
125	Jet Force 125	03>04	0360		2810		0363			
125	Looxor 125	03>	0970		0080		0973	0083		
125	Ludix 125	04>	0080				0083			
125	Lxr 125	10>	1420				1423			
125	Rs 125 Geopolis	10>	2620		2810		2623			
125	Satelis 125	04>	0080		2810		0083			
125	Satelis 125	06>	0360		0080		0363	0083		
125	Satelis 125 Abs	04>	0870		2810		0873			

PASTIGLIE FRENO RMS - SINTER (RICERCA PER MARCA)

RMS - SINTER BRAKE PADS (SEARCH BY BRAND)

















CC	MODELLO MODEL	ANNO YEAR	RMS YOUR BEST PARTNER				SINTER	
			ANTERIORE - FRONT		POSTERIORE - REAR		ANTERIORE FRONT	POSTERIORE REAR
			PASTIGLIA ORGANICA - ORGANIC				PASTIGLIA SINTERIZZATA SINTERED	
			OMOLOGATA HOMOLOGATED	NON OMOLOGATA NOT HOMOLOGATED	GANASCE BRAKE SHOES	OMOLOGATA HOMOLOGATED	NON OMOLOGATA NOT HOMOLOGATED	GANASCE BRAKE SHOES
22 510		22 512	22 510		22512	22 510	22 510	
125	Sv 125 C Executive	96>	2630		2633			
125	Sv 125 Executive	94>	2630		2633			
125	Sv 125 Geo	92>92	0170		0091			
125	Sv 125 Geo	93>	2630		2633			
125	Vivacity 125	10>	1420		1423			
150	Elyseo 150	01>	0360		2810	0363		
150	Elyseo 150	99>	0080		0083			
150	Elystar 150	02>	0360		2810	0363		
150	Looxor 150	03>	2670	0440	2673			
200	Lxr 200	10>	1420		1423			
250	Geopolis 250	06>	2620		2620	2623	2623	
250	Geostyle 250	10>	1420		1420	1423	1423	
250	Satelis 250	06>	2620		2620	2623	2623	
250	Sv 250	01>	0340		2610	0343	2613	
400	Geopolis 400 (Pinze Ajp)	07>	0360		2810	0363		
400	Geopolis 400 (Pinze Nissin)	07>	1420		1420	1423	1423	
400	Geopolis 400 Rs	08>	0870		1420	0873	1423	
500	Satelis 500	06>	0490		0490	0493	0493	
500	Satelis 500	07>	0870		1420	0873	1423	
600	Satelis 600 Abs	04>	0870		2810	0873		
PGO								
50	Big Max 50	94>02	0180					
50	Big Max 50	03>	0040					
50	Big Max 50 Cromo	-	0040					
50	Comet 50	91>	0040					
50	Dr Big 50	01>	2750		2753			
50	G Max 50	06>	2750		2753			
50	G Max 50 Doppler	06>	0010		0013			
50	Galaxi 50	92>	0040					
50	Galaxi 90	92>	0040					
50	Libra 50	10>	2750		2753			
50	Ligero 50	06>	2750		2753			
50	Mega 50	-	0040					
50	Pm 50 X	-	0180					
50	Pm 50 X Sport	00>	2750		2753			
50	Ps 50	93>	0040					
50	Tornado 50	-	0180					
50	T-Rex 50 2T	00>	2750		2753			
90	Big Max 90	95>	0180					



PASTIGLIE FRENO RMS - SINTER (RICERCA PER MARCA)

RMS - SINTER BRAKE PADS (SEARCH BY BRAND)

CC	MODELLO MODEL	ANNO YEAR								
			 ANTERIORE - FRONT		 POSTERIORE - REAR		 ANTERIORE FRONT	 POSTERIORE REAR		
			PASTIGLIA ORGANICA - ORGANIC				PASTIGLIA SINTERIZZATA SINTERED			
			 OMOLOGATA HOMOLOGATED	 NON OMOLOGATA NOT HOMOLOGATED	 GANASCE BRAKE SHOES	 OMOLOGATA HOMOLOGATED	 NON OMOLOGATA NOT HOMOLOGATED	 GANASCE BRAKE SHOES		
			22 510		22 512	22 510		22512	22 510	22 510
90	Rodoshow 90	02>	3210							
100	My Bubu 100	02>	2750				2753			
125	Charge 125	02>	2750				2753			
125	Libra 125	10>	1420				1423			
125	Ligero 125	06>	2750				2753			
125	My Bubu 125	02>	2750				2753			
125	T-Rex 125 2T	00>	2750				2753			
125	T-Rex 125 4T	95>	2750				2753			
125	X Hot 125	10>	1420				1423			
150	Br 150 Bugxter	05>	1440							
150	Tr 3 150	02>	2750				2753			
150	T-Rex 150 4T	00>	2750				2753			
250	G Max 250	06>	0520				0523			
	I Dep	09>	2750				2753			
PGO ATV										
50	50 Bugdrider	06>	1440							
50	X Rider 50	03>	0040							
125	X Rider 125	03>	0040							
150	Br 150 E Bugdrider	04>07	1440							
150	X Rider 150	03>	0040							
PIAGGIO										
50	Dna 50	00>	0360		0450	0363	0453			
50	Fly 50 2T	05>07	2620			0560	2623			
50	Fly 50 2T	10>	2620			0560	2623			
50	Fly 50 4T	05>10	2620			0560	2623			
50	Free 50	93>95		0191						
50	Free 50	96>	0070			0360				
50	Free 50 (Ruote In Lega)	96>				0301				
50	Liberty 50	97>	0300			0560	0303			
50	Liberty 50 4T	00>	0300			0560	0303			
50	Nrg 50	94>95	0190			0301	0193			
50	Nrg 50	96>	0190				0193			
50	Nrg 50 Mc2	96>	0190				0193			
50	Nrg 50 Mc2 Dd	98>	0190		0300	0193	0303			
50	Nrg 50 Mc3	05>	0190		0300	0193	0303			
50	Nrg 50 Power Dd	04>05	0190		0300	0193	0303			
50	Nrg 50 Purejet	02>04	0190		0300	0193	0303			
50	Ntt 50	96>	0190			0193				

PASTIGLIE FRENO RMS - SINTER (RICERCA PER MARCA)

RMS - SINTER BRAKE PADS (SEARCH BY BRAND)

















CC	MODELLO MODEL	ANNO YEAR	RMS YOUR BEST PARTNER				SINTER			
			ANTERIORE - FRONT		POSTERIORE - REAR		ANTERIORE FRONT	POSTERIORE REAR		
			PASTIGLIA ORGANICA - ORGANIC				PASTIGLIA SINTERIZZATA SINTERED			
			OMOLOGATA HOMOLOGATED	NON OMOLOGATA NOT HOMOLOGATED	GANASCE BRAKE SHOES	OMOLOGATA HOMOLOGATED	NON OMOLOGATA NOT HOMOLOGATED	GANASCE BRAKE SHOES		
22 510		22 512	22 510		22512	22 510	22 510			
50	Ntt 50	>95	0190		0301		0193			
50	Quartz 50	92>	0160		0301					
50	Sfera 50	91>			0301					
50	Sfera 50 Rst	95>	0260		0360					
50	Velofax 50	96>	0351							
50	Vespa 50	-	0171							
50	Vespa 50 Et2	97>	0300		0351		0303			
50	Vespa 50 Et4	99>	0300		0351		0303			
50	Vespa 50 Hp	92>	0570		0570					
50	Vespa 50 Lx 2T	05>	0300		0351		0303			
50	Vespa 50 Lx 2T Touring	10>	0300		0351		0303			
50	Vespa 50 Lx 4T	05>	0300		0351		0303			
50	Vespa 50 Lx 4T 4V Touring	10>	0300		0351		0303			
50	Vespa 50 Pk Special - XL	86>	0171		0161					
50	Vespa 50 Pk XL 2	-	0570		0570					
50	Vespa 50 Pk XL 2 Automatica	-	0570							
50	Vespa 50 Special	-	0171		0181					
50	Vespa 50 V FL 2	90>	0570		0570					
50	Zip 50	92>93			0301					
50	Zip 50	99>			0351					
50	Zip 50 Fast Rider	93>95	0190		0360		0193			
50	Zip 50 Fast Rider	95>	0190		0351		0193			
50	Zip 50 Rst	96>97			0351					
50	Zip 50 Rst	98>	0300				0303			
50	Zip 50 Sp	96>	0300		0351		0303			
80	Sfera 80	94>			0301					
90	Vespa 90 Primavera	-	0171		0181					
100	Fly 100 4T	06>08	2620		0421		2623			
100	Free 100	01>	0300		0421		0303			
125	Beverly 125 (Pinza Grimeca)	01>	0360		0360		0363			
125	Beverly 125 (Pinza Heng tong)	01>	2620		2620		2623			
125	Beverly 125 Rst	05>	2620		2620		2623			
125	Beverly 125 Rst 4T 4V ie Eu3	10>	2620		2620		2623			
125	Carnaby 125	07>10	2620		2620		2623			
125	Dna 125	00>	0360		0450		0363			
125	Fly 125	05>07	2620		0421		2623			
125	Fly 125 Eu3	07>08	2620		0421		2623			
125	Hexagon 125	94>	0190		0351		0193			



PASTIGLIE FRENO RMS - SINTER (RICERCA PER MARCA)











RMS - SINTER BRAKE PADS (SEARCH BY BRAND)

CC	MODELLO MODEL	ANNO YEAR								
			 ANTERIORE - FRONT		 POSTERIORE - REAR		 ANTERIORE FRONT	 POSTERIORE REAR		
			PASTIGLIA ORGANICA - ORGANIC				PASTIGLIA SINTERIZZATA SINTERED			
			 OMOLOGATA HOMOLOGATED	 NON OMOLOGATA NOT HOMOLOGATED	 GANASCE BRAKE SHOES	 OMOLOGATA HOMOLOGATED	 NON OMOLOGATA NOT HOMOLOGATED	 GANASCE BRAKE SHOES		
			22 510		22 512	22 510		22512	22 510	22 510
125	Hexagon 125 Lx	98>	0360			0421	0363			
125	Liberty 125 4T	98>	0300			0421	0303			
125	Mp3 125	06>08	0300		0780		0303			
125	Mp3 125 Ibrido	09>10	0300		2620		0303 2623			
125	Mp3 125 ie	08>09	0300		2620		0303 2623			
125	Sfera 125	95>	0260							
125	Sfera 125 (4 Tempi)	96>	0300			0351	0303			
125	Skipper 125	93>97	0160			0351				
125	Skipper 125 St 4T	98>	0360			0421	0363			
125	Super Hexagon 125 Gtx	01>	2620		0450		2623 0453			
125	Super Hexagon 125 Gtx	>00	0360		0300		0363 0303			
125	Vespa 125	51>62		0171		0551				
125	Vespa 125	63>72		0171		0531				
125	Vespa 125 Et3	-		0171		0181				
125	Vespa 125 Et4	96>	0300			0351	0303			
125	Vespa 125 Granturismo L (Pinza Grim.)	03>	0360		0450		0363 0453			
125	Vespa 125 Granturismo L (Pinza Heng tong)	03>	2620		0450		2623 0453			
125	Vespa 125 Lx	05>	0300			0351	0303			
125	Vespa 125 Lx ie Eu3	09>10	0300			0351	0303			
125	Vespa 125 Lx Touring	10>	0300			0351	0303			
125	Vespa 125 Lxv ie 4T	10>	0300			0351	0303			
125	Vespa 125 Pk Automatica	84>		0570						
125	Vespa 125 Pk Special - XL	86>		0570		0570				
125	Vespa 125 Pk XL 2	-		0570		0570				
125	Vespa 125 Primavera	-		0171		0181				
125	Vespa 125 Px	78>		0570		0570				
125	Vespa 125 Px	98>	0160			0161				
125	Vespa 125 Px Arcobaleno	83>		0570		0570				
125	Vespa 125 S 4T ie & College	09>10	0300			0351	0303			
125	Vespa 125 V FL2	91>		0570		0570				
125	X 125 Evo	07>	2620		2600		2623 2603			
125	X7 125	08>	2620		2620		2623 2623			
125	X8 125	04>	2620		0490		2623 0493			
125	X8 125 (Pinza Heng tong)	05>	2620		0780		2623			
125	X8 125 Premium	06>	2620		0780		2623			
125	X8 125 Street Eu3	06>	2620			0421	2623			
125	X9 125 Evolution	01>03	0490		0490		0493 0493			

PASTIGLIE FRENO RMS - SINTER (RICERCA PER MARCA)

RMS - SINTER BRAKE PADS (SEARCH BY BRAND)

















CC	MODELLO MODEL	ANNO YEAR	RMS YOUR BEST PARTNER				SINTER	
			 ANTERIORE - FRONT		 POSTERIORE - REAR		 ANTERIORE FRONT	 POSTERIORE REAR
			PASTIGLIA ORGANICA - ORGANIC				PASTIGLIA SINTERIZZATA SINTERED	
								
			OMOLOGATA HOMOLOGATED	NON OMOLOGATA NOT HOMOLOGATED	GANASCE BRAKE SHOES	OMOLOGATA HOMOLOGATED	NON OMOLOGATA NOT HOMOLOGATED	GANASCE BRAKE SHOES
22 510		22 512	22 510		22512	22 510	22 510	
125	X9 125 Evolution	05>07	2600		0490		2603	0493
125	X9 125 Evolution (Pinza Dx Heng tong)	01>	2600		0780		2603	
125	X9 125 Evolution (Pinza Sx Heng tong)	01>	2620		0780		2623	
125	Zip 125	00>	0300			0351	0303	
150	Fly 150	05>07	2620				2623	
150	Fly 150 Eu3	08>10	2620				2623	
150	Hexagon 150	94>99	0190			0351	0193	
150	Liberty 150 Le	00>	0300			0421	0303	
150	Skipper 150	93>97	0160			0351		
150	Skipper 150 St 4T	98>	0360			0421	0363	
150	Vespa 150	51>62		0171		0551		
150	Vespa 150	63>72		0171		0531		
150	Vespa 150 Et4	96>	0300			0351	0303	
150	Vespa 150 Lx	05>	0300			0351	0303	
150	Vespa 150 Lx ie Eu3	09>10	0300			0351	0303	
150	Vespa 150 Lx Touring	10>	0300			0351	0303	
150	Vespa 150 Px	78>		0570		0570		
150	Vespa 150 Px	98>	0160			0161		
150	Vespa 150 Px Arcobaleno	83>		0570		0570		
150	Vespa 150 S 4T ie & College	09>10	0300			0351	0303	
150	Vespa 150 Sprint Veloce	-		0520		0161		0523
150	Vespa 150 Super	-		0171		0540		
150	X8 150 Street Eu3	06>	2620			0421	2623	
160	Vespa 160 Gs	-		0520		0161		0523
180	Dna 180	01>	0360		0450		0363	0453
180	Hexagon 180 Lx	98>	0360			0421	0363	
180	Super Hexagon 180 Gtx	01>	2620		0450		2623	0453
180	Super Hexagon 180 Gtx	>00	0360		0300		0363	0303
180	Vespa 180 Ss	-		0520		0161		0523
180	X9 180 Amalfi	01>	0490		0490		0493	0493
200	Beverly 200 (Pinza Grimeca)	01>	0360		0360		0363	0363
200	Beverly 200 (Pinza Heng tong)	01>	2620		2620		2623	2623
200	Carnaby 200	07>08	2620		2620		2623	2623
200	Liberty 200 4T	06>	0300			0421	0303	
200	Liberty 200 4T Sport	06>	0300			0421	0303	
200	Vespa 200 GT L (Pinza Grimeca)	03>	0360		0450		0363	0453
200	Vespa 200 GT L (Pinza Heng tong)	03>	2620		0450		2623	0453
200	Vespa 200 Pe	83>		0570		0570		



PASTIGLIE FRENO RMS - SINTER (RICERCA PER MARCA)

RMS - SINTER BRAKE PADS (SEARCH BY BRAND)

CC	MODELLO MODEL	ANNO YEAR								
			 ANTERIORE - FRONT		 POSTERIORE - REAR		 ANTERIORE FRONT	 POSTERIORE REAR		
			PASTIGLIA ORGANICA - ORGANIC				PASTIGLIA SINTERIZZATA SINTERED			
			 OMOLOGATA HOMOLOGATED	 NON OMOLOGATA NOT HOMOLOGATED	 GANASCE BRAKE SHOES	 OMOLOGATA HOMOLOGATED	 NON OMOLOGATA NOT HOMOLOGATED	 GANASCE BRAKE SHOES		
			22 510		22 512	22 510		22512	22 510	22 510
200	Vespa 200 Px	98>	0160			0161				
200	Vespa 200 Px Arcobaleno	83>			0570		0570			
200	Vespa 200 Px E	78>			0570		0570			
200	Vespa 200 Rally	-			0520		0161	0523		
200	X8 200	04>	2620			0490	2623	0493		
200	X8 200 (Pinza Heng tong)	05>	2620			0780	2623			
200	X9 200 Evolution	03>	0490			0490	0493	0493		
250	Beverly 250 Cruiser	07>	2620			2620	2623	2623		
250	Beverly 250 Eu3	06>	2620			2620	2623	2623		
250	Beverly 250 Leader	04>	2620			2620	2623	2623		
250	Beverly 250 Rst	05>	2620			2620	2623	2623		
250	Beverly 250 Sport	06>	2620			2620	2623	2623		
250	Carnaby 250	08>	2620			2620	2623	2623		
250	Hexagon 250	98>	0360				0400	0363		
250	Mp3 250	06>08	0300			0780	0303			
250	Mp3 250 Lt	09>	0300			2620	0303	2623		
250	Mp3 250 Mic	08>09	0300			2600	0303	2603		
250	Super Hexagon 250 Gtx	00>	0360			0450	0363	0453		
250	Vespa 250 Gts (Pinza Grimeca)	05>	0360			0450	0363	0453		
250	Vespa 250 Gts (Pinza Heng tong)	05>	2620			0450	2623	0453		
250	Vespa 250 Gtv	06>	2620			0450	2623	0453		
250	X 250 Evo	07>	2620			2600	2623	2603		
250	X7 250 Eu3	08>	2620			2600	2623	2603		
250	X9 250 Amalfi	00>	0490			0490	0493	0493		
250	X9 250 Evolution (Pinza Dx)	04>	2620			0490	2623	0493		
250	X9 250 Evolution (Pinza Sx)	04>	2600				2603			
250	X9 250 Evolution (Pinza Dx)	05>06	2620			0780	2623	0783		
250	X9 250 Evolution (Pinza Sx)	05>06	2600				2603			
300	Beverly 300 Tourer Eu3	09>10	2620			2620	2623	2623		
300	Carnaby 300	09>10	2620			2620	2623	2623		
300	Mp3 300 4T 4V ie Lt Ibrido	10>	0300			2620	0303	2623		
300	Mp3 300 ie Lt	10>11	0300			2620	0303	2623		
300	Mp3 300 ie Mic	10>	0300			2620	0303	2623		
300	Vespa 300 Gts Super	08>	2620			0450	2623	0453		
400	Beverly 400 Eu3	06>	0430			2620		2623		
400	Beverly 400 Tourer Eu3	08>10	0490			0780	0493			
400	Mp3 400	07>08	0300			2620	0303	2623		
400	Mp3 400 ie Lt / ie Lt Sport	08>10	0300			2620	0303	2623		















PASTIGLIE FRENO RMS - SINTER (RICERCA PER MARCA)

RMS - SINTER BRAKE PADS (SEARCH BY BRAND)



CC	MODELLO MODEL	ANNO YEAR	RMS YOUR BEST PARTNER				SINTER	
			ANTERIORE - FRONT		POSTERIORE - REAR		ANTERIORE FRONT	POSTERIORE REAR
			PASTIGLIA ORGANICA - ORGANIC				PASTIGLIA SINTERIZZATA SINTERED	
			OMOLOGATA HOMOLOGATED	NON OMOLOGATA NOT HOMOLOGATED	GANASCE BRAKE SHOES	OMOLOGATA HOMOLOGATED	NON OMOLOGATA NOT HOMOLOGATED	GANASCE BRAKE SHOES
22 510		22 512	22 510		22512	22 510	22 510	
400	Mp3 400 Mic	08>09	0300		2620		0303	2623
400	X Evo 400 (Pinza Dx)	07>11	2600				2603	
400	X Evo 400 (Pinza Sx)	07>11	2620		2620		2623	2623
400	X8 400 (Pinza Dx)	06>	2620		2620		2623	2623
400	X8 400 (Pinza Sx)	06>	2600				2603	
400	X8 400 Eu3 (Pinza Dx)	06>08	2600				2623	
400	X8 400 Eu3 (Pinza Sx)	06>08	2620		2620		2623	2623
500	Beverly 500	03>	0490		0490		0493	0493
500	Beverly 500 (Pinza Hengtong)	05>06	0490		0780		0493	
500	Beverly 500 Cruiser	07>09	0490		0780		0493	
500	Beverly 500 Eu3	06>08	0490		0780		0493	
500	X9 500	01>03	0490		0490		0493	0493
500	X9 500 Evolution	03>04	0430		0490			0493
500	X9 500 Evolution Abs	05>	0430		0490			0493
PIAGGIO (ciclomotori)								
50	Boss 50	88>					0230	
50	Boxer 50	-		0191			0230	
50	Bravo 50	-		0191			0230	
50	Bravo 50 (Ruote In Lega Mozzo 90 mm)	87>					0230	
50	Bravo 50 (Ruote In Lega)	87>		0201			0230	
50	Ciao 50	-		0191			0230	
50	Ciao 50 (Ruote In Lega)	87>		0201			0230	
50	Ciao 50 Mix	97>					0230	
50	Grillo 50	89>		0201			0230	
50	Si 50	-		0191			0230	
50	Si 50 (Ruote In Lega)	80>		0201			0230	
50	Si 50 Mix	97>					0230	
50	Super Bravo 50	85>		0191			0230	
50	Superbravo 50 3 Marce	87>		0201				
PIAGGIO (motocarri)								
50	Ape 50 Eu2	03>10		0171			0221	
50	Ape 50 FL / FL2	89>95		0171			0221	
50	Ape 50 FL3 Europa	96>99		0171			0221	
50	Ape 50 P	80>85		0171			0221	
50	Ape 50 Rst Mix	99>05		0171			0221	
50	Ape 50 Tm P	85>89		0171			0221	
150	Ape 150 C 1/2/3	-		0171				
150	Ape 150 C4	-		0171				

**PASTIGLIE FRENO RMS - SINTER (RICERCA PER MARCA)****RMS - SINTER BRAKE PADS (SEARCH BY BRAND)**

CC	MODELLO MODEL	ANNO YEAR	 YOUR BEST PARTNER							
			 ANTERIORE - FRONT		 POSTERIORE - REAR		 ANTERIORE FRONT	 POSTERIORE REAR		
			PASTIGLIA ORGANICA - ORGANIC				PASTIGLIA SINTERIZZATA SINTERED			
			 OMOLOGATA HOMOLOGATED	 NON OMOLOGATA NOT HOMOLOGATED	 GANASCE BRAKE SHOES	 OMOLOGATA HOMOLOGATED	 NON OMOLOGATA NOT HOMOLOGATED	 GANASCE BRAKE SHOES		
			22 510	22 512	22 510	22512	22 510	22 510		
175	Ape 175 Pentaro'	-	0171							
220	Ape Car 220 P2/P3 (Kit 3 Ganasce)	78-85	0261		0261					
220	Ape TM 220 (Kit 3 Ganasce)	09-10	0261		0261					
220	Ape TM 220 P602 (Kit 3 Ganasce)	82-83	0261		0261					
220	Ape TM 220 P703/P703V/FL2 (Kit 3 Gan.)	84-02	0261		0261					
420	Ape Car 420 Diesel (Kit 3 Ganasce)	86-96	0251		0251					
420	Ape Car 420 Max Diesel 9Q (Kit 3 Ganasce)	86-96	0251		0251					
420	Ape MP 420 601 Classic (Kit 3 Ganasce)	06-07	0261		0261					
420	Ape TM 420 Diesel LCS (Kit 3 Ganasce)	05-10	0261		0261					
420	Ape TM 420 P703/P703V Diesel (Kit 3 Gan.)	87-04	0261		0261					
PIAGGIO (Spagna)										
50	Vespino 50	80>	0201							
50	Vespino 50	>79	0191							
80	Vespa 80	-	0171		0161					
80	Vespa 80 Px	-	0171		0161					
80	Vespa 80 Special	-	0171		0161					
125	Vespa 125 Px	-	0570		0570					
150	Vespa 150 Px	-	0570		0570					
PINZE CALIPERS RACING										
	Minimoto Tipo Polini	-	3220			3223				
PIAGGIO (ciclomotori)										
	Pinza Brembo Racing (Serie 4 Pz)	-				3043				
POLARIS ATV										
250	Cyclone 250 X	87>	0061							
	Scrambler (3 Wheeler)	85>86	0061							
	Trail Boss 2X4	85>87	0061							
	Trail Boss 4X4	87>	1440							
POLINI										
50	Cross 50	99>	1400		1400					
50	X1- X2 50 R	04>	3220		3220	3223 3223				
65	X5 65 Rp	05>	3220		3220	3223 3223				
PRAGA										
250	Ed 250	99>	0430		1330	1333				
610	Cd 610	99>	0430		1330	1333				
PUCH										
50	Condor 50	-	0080			0083				
50	Monza 50	85>	0080			0083				
75	Cobra 75	85>	0080			0083				

PASTIGLIE FRENO RMS - SINTER (RICERCA PER MARCA)

RMS - SINTER BRAKE PADS (SEARCH BY BRAND)

















CC	MODELLO MODEL	ANNO YEAR	RMS YOUR BEST PARTNER				SINTER	
			ANTERIORE - FRONT		POSTERIORE - REAR		ANTERIORE FRONT	POSTERIORE REAR
			PASTIGLIA ORGANICA - ORGANIC				PASTIGLIA SINTERIZZATA SINTERED	
			OMOLOGATA HOMOLOGATED	NON OMOLOGATA NOT HOMOLOGATED	GANASCE BRAKE SHOES	OMOLOGATA HOMOLOGATED	NON OMOLOGATA NOT HOMOLOGATED	GANASCE BRAKE SHOES
22 510		22 512	22 510		22512	22 510	22 510	
80	Cobra 80	84>	0080				0083	
80	Maxi 80	88>	0010				0013	
125	125	87>	0060				0063	
250	Cross 250	86>86	0010					
250	Hfe 250	86>86	0010					
600	Enduro 600 4 Valves	85>	0010				0013	
RACING CALIPERS								
	Minimoto Tipo Cs Racing	-	1400					
	Minimoto Tipo Grc	-	1400					
	Minimoto Tipo Polini	-	1400					
RAPIDO								
50	Screnna 50	-					0061	
RIEJU								
50	Drac 50	97>	0080		0080		0083	0083
50	Drag 50	92>	0030					
50	Fd4 50 Super Maraton	85>	0080				0083	
50	First 50 H2o	97>	0080				0083	
50	Mrx 50 Pro	05>	0740		0080		0083	
50	Mrx 50 Racing	02>	0080		0080		0083	0083
50	Nkd 50	05>	0560		0080		0083	
50	Racing 50 Special Edition	01>	0740		0080		0083	
50	Rr 50	96>	0080		0080		0083	0083
50	Rr 50 Supermotard	96>	0080		0080		0083	0083
50	Rrx 50	08>	0080		0080		0083	0083
50	Rrx 50 Spike	08>	0080		0080		0083	0083
50	Rs1 50	92>	0080		0080		0083	0083
50	Rs1 50 Castrol	01>	0360		0080		0363	0083
50	Rs1 50 Evolution	96>00	0080		0080		0083	0083
50	Rs2 50 Matrix	03>	0560		0080		0083	
50	Rv 50	-	0080				0083	
50	Smx 50	02>	0740		0080		0083	
50	Smx 50 Pro	08>	0490		0080		0493	0083
50	Spike 50	02>	0080		0080		0083	0083
50	Spike 50 Racing	02>	0740		0080		0083	
50	Tango 50	08>	0490		0080		0493	0083
50	Windy 50	97>	0080				0083	
75	K6 75 Lc Strada	87>	0080				0083	
75	P6 75 Lc Strada	87>	0080				0083	



PASTIGLIE FRENO RMS - SINTER (RICERCA PER MARCA)

RMS - SINTER BRAKE PADS (SEARCH BY BRAND)

CC	MODELLO MODEL	ANNO YEAR								
			 ANTERIORE - FRONT		 POSTERIORE - REAR		 ANTERIORE FRONT	 POSTERIORE REAR		
			PASTIGLIA ORGANICA - ORGANIC				PASTIGLIA SINTERIZZATA SINTERED			
			 OMOLOGATA HOMOLOGATED	 NON OMOLOGATA NOT HOMOLOGATED	 GANASCE BRAKE SHOES	 OMOLOGATA HOMOLOGATED	 NON OMOLOGATA NOT HOMOLOGATED	 GANASCE BRAKE SHOES		
			22 510	22 512	22 510	22512	22 510	22 510		
80	Mr 80	-	0080				0083			
80	Rst 80	91>	0080		0080		0083	0083		
125	Mrx 125	03>	0740		0080		0083			
125	Rr 125	97>	0080		0080		0083	0083		
125	Rs2 125 Nkd	06>	2820		0040		2823			
125	Rs2 125 Pro	08>			0080		0083			
125	Smx 125	03>	0740		0080		0083			
125	Tango 125	06>08	3160		0080		3163	0083		
125	Tango 125	08>	0490		0080		0493	0083		
125	Tango 125 Pro	08>	0490		0080		0493	0083		
125	Rs2 Pro	08	3260							
450	Mrx 450	08>	0430		0750		0753			
805	Mr 805 C / E	88>	0080				0083			
805	Mr 805 Cross / Enduro	87>	0080				0083			
RIZZATO										
50	Atala Califfone 50 (Ruota Raggi)	-			0201		0201			
50	Atala Carosello 50	97>	0070							
50	Atala Hacker 50	95>	0190				0193			
50	Atala Uno 50 (Ruota Raggi)	-			0191		0191			
SACHS										
50	Mad Ass 50	04>	2590				2593			
50	Mad Ass 50 4T	05>	2590		0080		2593	0083		
80	Sv 80 Lotus	-	0010				0013			
125	Roadster 125 V2	01>	0060				0063			
125	X Road 125	05>	0520				0523			
125	Xtc 125	99>	0520				0523			
125	Xtc 125 N	99>	0520				0523			
125	Zx 125	99>	0060				0063			
125	Zz 125	99>	0060				0063			
500	Mad Ass 500	05>	0520				0523			
650	Roadster 650 V 1.6	01>	0520				0523			
800	Roadster 800 V 2	00>	0520				0523			
805	B 805	02>	0520				0523			
805	S 805	03>	0520				0523			
SANGLAS										
400	Y 400	79>80	0010		0010		0013	0013		
500	S2 500	79>80	0010		0010		0013	0013		

PASTIGLIE FRENO RMS - SINTER (RICERCA PER MARCA)

RMS - SINTER BRAKE PADS (SEARCH BY BRAND)

















CC	MODELLO MODEL	ANNO YEAR	RMS YOUR BEST PARTNER				SINTER	
			ANTERIORE - FRONT		POSTERIORE - REAR		ANTERIORE FRONT	POSTERIORE REAR
			PASTIGLIA ORGANICA - ORGANIC				PASTIGLIA SINTERIZZATA SINTERED	
			OMOLOGATA HOMOLOGATED	NON OMOLOGATA NOT HOMOLOGATED	GANASCE BRAKE SHOES	OMOLOGATA HOMOLOGATED	NON OMOLOGATA NOT HOMOLOGATED	GANASCE BRAKE SHOES
22 510		22 512	22 510		22512	22 510	22 510	
SCORPA								
125	Sy 125 F	03>	0640		0650			
250	255 250 Works	95>	0080		0080		0083	0083
250	Sy 250	00>	0640		0650			
250	Sy 250 Long Ride	04>	0640		0650			
250	T Ride	08					3343	
280	Easy Race 280	99>	0080		0080		0083	0083
SHERCO								
50	Enduro 50	02>	0740		0080			0083
50	Supermotard 50	02>	0740		0080			0083
80	80 0.8	01>	0080		0080		0083	0083
125	City Corp 125 4T Enduro	03>	0740		0080			0083
125	City Corp 125 4T Sm	03>	0740		0080			0083
125	Trial 125	99>00	0010		0010		0013	0013
125	Trial 125	02>	0740		0080			0083
125	Trial 125 1.25	99>02	0080		0080		0083	0083
125	Trial 125 1.25	03>	0640		0650			
200	Trial 200 2.0	99>	0080		0080		0083	0083
250	Trial 250 2.5	99>01	0080		0080		0083	0083
250	Trial 250 2.5	02>	0640		0650			
290	Trial 290 2.9	02>05	0640		0650			
290	Trial 290 2.9	>01	0080		0080		0083	0083
290	Trial 290 3.2 4T	05>	0640		0650			
450	Enduro 450 4.5 I	04>05	0430		1450			1453
SIAM								
50	Falcon 50	97>	0190				0193	
50	Mat 50	97>	0040					
50	Scross 50	97>	0190				0193	
100	Mat 100	97>	0040					
SIAMOTO								
50	Birdie 50	02>	0180					
125	Bd - Kd 125	02>	0740					
SIMSON								
50	Habict 50 Cx	01>	0010				0013	
50	Spatz 50	99>	0010				0013	
50	Sperber 50	99>	0010				0013	
50	Sr 50 /1 Gamma	94>	0080				0083	
50	Sr 50 Gamma E	94>	0080				0083	
50	Sr 50 Xc/Xce	-	0080				0083	



PASTIGLIE FRENO RMS - SINTER (RICERCA PER MARCA)

RMS - SINTER BRAKE PADS (SEARCH BY BRAND)

CC	MODELLO MODEL	ANNO YEAR								
			 ANTERIORE - FRONT		 POSTERIORE - REAR		 ANTERIORE FRONT	 POSTERIORE REAR		
			PASTIGLIA ORGANICA - ORGANIC				PASTIGLIA SINTERIZZATA SINTERED			
			 OMOLOGATA HOMOLOGATED	 NON OMOLOGATA NOT HOMOLOGATED	 GANASCE BRAKE SHOES	 OMOLOGATA HOMOLOGATED	 NON OMOLOGATA NOT HOMOLOGATED	 GANASCE BRAKE SHOES		
			22 510	22 512	22 510	22512	22 510	22 510		
50	Star 50	99>	0010				0013			
80	Ifa 80	89>	0010				0013			
80	S 83 Cx / Or	-	0010				0013			
80	Sr 80 /1 Gamma	94>	0080				0083			
80	Sr 80 2 Ce	89>	0010				0013			
80	Sr 80 Xce	-	0080				0083			
125	Rs 125	01>	0060				0063			
125	Schikra 125	99>	0060		0010		0063	0013		
125	Sm 125	01>	0740		0080			0083		
125	Star 125	99>	0080				0083			
SULA										
50	City Bird 50	99>	0180			0061				
50	Thunder Bird 50	99>	0040			0061				
100	Thunder Bird 100	99>	0040			0061				
125	Thunder Bird 125	99>	0040			0061				
SUZUKI										
50	Adress 50	92>	0040							
50	Ap 50	95>	3210							
50	Ay 50 A	04>06	0080		0080		0083	0083		
50	Ay 50 Katana (Pinza Brembo)	97>	0190			0130	0193			
50	Ay 50 W (Katana)	00>04	0080		0080		0083	0083		
50	Ay 50 W Katana	98>	0080			0130	0083			
50	Ay 50 Wr Katana	98>	0080			0130	0083			
50	Cp	85>93		0130		0130				
50	Cp Chf	85>93		0130		0130				
50	Dr 50 Big	89>	0080				0083			
50	Lido	85>93		0130		0130				
50	Or 50	80>	1200							
50	Rg 50 Gag - Gamma	87>	0720				0723			
50	Rme 50	10>			0660			0663		
50	Rmx 50	00>	0080		0080		0083	0083		
50	Sepia 50	92>	0040			0130				
50	Sepia Au 50 Zz	96>	0040							
50	Smx 50 Super Motard	00>	0080		0080		0083	0083		
50	Tr 50 Street Magic	98>		0370						
50	Tune 50	93>	0040							
50	Tzr 50	97>	1070				1073			
50	Uf 50 Estilete	00>	0080			0130	0083			

PASTIGLIE FRENO RMS - SINTER (RICERCA PER MARCA)

RMS - SINTER BRAKE PADS (SEARCH BY BRAND)

















CC	MODELLO MODEL	ANNO YEAR	RMS YOUR BEST PARTNER				SINTER	
			ANTERIORE - FRONT		POSTERIORE - REAR		ANTERIORE FRONT	POSTERIORE REAR
			PASTIGLIA ORGANICA - ORGANIC				PASTIGLIA SINTERIZZATA SINTERED	
			OMOLOGATA HOMOLOGATED	NON OMOLOGATA NOT HOMOLOGATED	GANASCE BRAKE SHOES	OMOLOGATA HOMOLOGATED	NON OMOLOGATA NOT HOMOLOGATED	GANASCE BRAKE SHOES
22 510		22 512	22 510		22512	22 510	22 510	
50	Ux 50 Zillion	98>	0080				0083	
50	Zr 50 Skx - Slkx	81>	1200					
50	Zz 50	92>	0040				0130	
65	Rm 65	03>			2850			2853
75	Lido 75	89>	0040					
80	3 E 80	-	1200					
80	Ah 80	92>	0040				0130	
80	Gt 80 L	81>	1200					
80	Rg 80 Gamma	>87	1200					
80	Rg 80 Gamma	88>93	3080				3083	
80	Rm 80 L/M	90>95	0040				0040	
80	Rm 80 X	86>89	0040					
80	Rm 80 Xt- Xv - X	96>01	0040					
85	Rm 85	02>04	0040					
100	Adress 100 V	95>	0040					
100	Gp 100 C - Den - N - X	78>	1200					
100	Rm 100	03>			2850			2853
110	Ug 110 Hokuto	00>	0370					
125	An 125	06>08	0040					
125	Dr 125 S	86>93	1440					
125	En 125	05>	1420				1423	
125	Gn 125 E-M-T	91>04	1200					
125	Gs 125 Esz	82>	1200					
125	Lido 125 Vario	90>	0040					
125	Rg 125 E	82>84	1200					
125	Rg 125 T - Fv	92>	1150				1153	
125	Rg 125 W Gamma	85>91	3080				3083	
125	Rm 125	05>	0920		2630		0923	2633
125	Rm 125	91>95	1420				1423	
125	Rm 125 H	87>	1420				1423	
125	Rm 125 J	88>	1420				1423	
125	Rm 125 K - L - M	89>90	1420		1790		1423	
125	Rm 125 T-K	96>06	0920		2630		0923	2633
125	Rv 125 Van Van	02>10	1250				1253	
125	Ts 125	90>	1420		1440		1423	
125	Ts 125 Rk	89>	1440		1790			
125	Ts 125 X	88>	1440					
125	Tx 125 Xf	85>	1440					



PASTIGLIE FRENO RMS - SINTER (RICERCA PER MARCA)











RMS - SINTER BRAKE PADS (SEARCH BY BRAND)

CC	MODELLO MODEL	ANNO YEAR								
			 ANTERIORE - FRONT		 POSTERIORE - REAR		 ANTERIORE FRONT	 POSTERIORE REAR		
			PASTIGLIA ORGANICA - ORGANIC				PASTIGLIA SINTERIZZATA SINTERED			
			 OMOLOGATA HOMOLOGATED	 NON OMOLOGATA NOT HOMOLOGATED	 GANASCE BRAKE SHOES	 OMOLOGATA HOMOLOGATED	 NON OMOLOGATA NOT HOMOLOGATED	 GANASCE BRAKE SHOES		
			22 510		22 512	22 510		22512	22 510	22 510
125	Uc Epicuro	01>	0370		0370					
125	Uh 125 Burgman	02>06	0430		0490		0493			
125	Uh 125 Burgman	07>	2540	2550 Con piastra	2870		2543	2873		
125	Ux 125 Sixteen	08>	2540	2550 Con piastra	0670		2543			
125	X4 125	-	1200							
150	An 150 Ty	96>	0370		0130					
150	Fx 150 4 Stroke	98>	1070		1070		1073	1073		
150	Rg 150 Water Cooled	98>	1070		1070		1073	1073		
150	Uc Epicuro	01>	0370		0370					
150	Ue 150	02>	0040							
150	Uh 150 Burgman	02>06	0430		0490		0493			
150	Ux 150 Sixteen	08>	2540	2550 Con piastra	0670		2543			
200	Dr 200	00>	1440							
200	Dr 200 K	89>	1440							
200	Rg 200 Gamma	93>	1150				1153			
200	Ts 200 R	90>	1420		1790		1423			
200	Uh 200 Burgman	07>09	2540	2550 Con piastra	2870		2543	2873		
250	250 Bandit	90>			0720			0723		
250	Across 250	90>			0720			0723		
250	An 250 Burgman	01>06	0380		0670		0383			
250	An 250 Burgman	96>00	0380		2650		0383	2653		
250	Cobra 250	89>	1150		0720		1153	0723		
250	Cobra 250	90>	1150		0720		1153	0723		
250	Djebel 250	93>	1420		1790		1423			
250	Dr 250 S	86>89	1440							
250	Dr 250 S	90>	1420		1790		1423			
250	Dr-Z 250	01>	0920		2630		0923	2633		
250	Gf 250 S	86>			0720			0723		
250	Goose 250	92>	1150		0720		1153	0723		
250	Gs 250 Fw	84>	0720		0720		0723	0723		
250	Gsx 250 S Katana	91>			0720			0723		
250	Gsx-R 250	87>88			0720			0723		
250	Gsx-R 250 R - R/Sp	89>	1150		0720		1153	0723		
250	Rg 250 W Gamma	>83	0720		0720		0723	0723		
250	Rg 250 W Gamma	84>87			0720			0723		
250	Rgv 250	93>	1150				1153			

PASTIGLIE FRENO RMS - SINTER (RICERCA PER MARCA)

RMS - SINTER BRAKE PADS (SEARCH BY BRAND)

















CC	MODELLO MODEL	ANNO YEAR	RMS YOUR BEST PARTNER				SINTER	
			 ANTERIORE - FRONT		 POSTERIORE - REAR		 ANTERIORE FRONT	 POSTERIORE REAR
			PASTIGLIA ORGANICA - ORGANIC				PASTIGLIA SINTERIZZATA SINTERED	
								
			OMOLOGATA HOMOLOGATED	NON OMOLOGATA NOT HOMOLOGATED	GANASCE BRAKE SHOES	OMOLOGATA HOMOLOGATED	NON OMOLOGATA NOT HOMOLOGATED	GANASCE BRAKE SHOES
22 510		22 512	22 510		22512	22 510	22 510	
250	Rgv 250	94>	1150			1153		
250	Rgv 250 R	88>	3030		0720	3033	0723	
250	Rgv 250 R	89>	1150		0720	1153	0723	
250	Rgv 250 R	90>92	1150			1153		
250	Rh 250 X	87>	1440					
250	Rm 250	91>92	1420			1423		
250	Rm 250	96>06	0920		2630	0923	2633	
250	Rm 250 H	87>88	1420			1423		
250	Rm 250 K - L - M	89>94	1420		1790	1423		
250	Rm 250 R-S	93>95	1420			1423		
250	Rm Z 250 (4T)	04>11	0920		1450	0923	1453	
250	Rm Z 250 (4T) Efi	10>	0920		1450	0923	1453	
250	Rmx 250	99>	0920		2630	0923	2633	
250	Rmx 250 Rp	89>95	1420		1790	1423		
250	Rmx 250 T/V	96>	0920		1790	0923		
250	Sky Wave 250 (Type li)	98>	0380		2650	0383	2653	
250	Ts 250 X All Models	86>86	1440					
250	Tu 250 X	00>01	1240			1243		
250	Wolf 250	90>			0720		0723	
350	Dr 350	90>	1420		1790	1423		
350	Dr 350 S-Sh-Se	93>	1420		1790	1423		
350	Goose 350	92>	1150		0720	1153	0723	
400	An 400 Burgman	98>00	0380		2650	0383	2653	
400	An 400 Burgman	01>06	0380		0670	0383		
400	An 400 Burgman (Pinza Dx)	07>	1070		1500	1073	1503	
400	An 400 Burgman (Pinza Sx)	07>	1420		1500	1423	1503	
400	Dr Z 400 S - E	00>05	0920		2630	0923	2633	
400	Dr Z 400 Sm	05>	0920		2630	0923	2633	
400	Gsf 400 Bandit	93>94	1150		0720	1153	0723	
400	Gsf 400 Bandit	95>	0870			0873		
400	Gsf 400 S Katana	89>90	1150			1153		
400	Gsx 400 F (Four) Fz	81>	1200					
400	Gsx 400 Fd	81>	1200					
400	Gsx 400 Fws - D - E	83>	0720		0720		0723	
400	Gsx 400 Impulse	94>	0870		0720	0873	0723	
400	Gsx 400 Katana	89>	1150		0720	1153	0723	
400	Gsx 400 R I/li	85>86			0720		0723	
400	Gsx 400 S	83>	0720		0720	0723	0723	



PASTIGLIE FRENO RMS - SINTER (RICERCA PER MARCA)











RMS - SINTER BRAKE PADS (SEARCH BY BRAND)

CC	MODELLO MODEL	ANNO YEAR	 YOUR BEST PARTNER							
			 ANTERIORE - FRONT		 POSTERIORE - REAR		 ANTERIORE FRONT	 POSTERIORE REAR		
			PASTIGLIA ORGANICA - ORGANIC				PASTIGLIA SINTERIZZATA SINTERED			
			 OMOLOGATA HOMOLOGATED	 NON OMOLOGATA NOT HOMOLOGATED	 GANASCE BRAKE SHOES	 OMOLOGATA HOMOLOGATED	 NON OMOLOGATA NOT HOMOLOGATED	 GANASCE BRAKE SHOES		
			22 510		22 512	22 510		22512	22 510	22 510
400	Gsx 400 X Impulse	86>88	0720				0723			
400	Gsx-R 400	90>	1060	0720		1063	0723			
400	Gsx-R 400 (Iii-Iv)	>88	0720				0723 0723			
400	Gsx-R 400 (V)	89>	1150	0720		1153	0723			
400	Gsx-R 400 (Japan)	85>	0720	0720				0723		
400	Gsx-R 400 R	90>	3030	0720		3033	0723			
400	Rf 400 Rvc	93>	0870	0720		0873	0723			
400	Rg 400 Gamma	85>	0720				0723			
450	Gs 450 S	87>	1200	0720		0723				
450	Rm X 450 (4T) Efi	10>	0920	1450		0923	1453			
450	Rm Z 450 (4T)	05>07	0920	1450		0923	1453			
450	Rm Z 450 (4T) Efi	08>	0920	1450		0923	1453			
500	Gs 500	04>	1250	0720		1253	0723			
500	Gs 500 Et/Ev	96>	1250	1253						
500	Gs 500 F	04>	1250	0720		1253	0723			
500	Rg 500 Rf Gamma	85>	0720				0723			
500	Rgv 500 Gamma	90>	1150	1153						
500	Rm 500	87>	1420	1423						
550	Gsx 550 Ef - Efe	83>	0720	0720		0723	0723			
550	Gsx 550 Es - Ese	83>	0720	0720		0723	0723			
550	Gsx 550 Esd - Es4	83>	0720	0720		0723	0723			
550	Gsx 550 Et - Ev	87>	0720	0720		0723	0723			
600	Gsf 600 Bandit	95>99	0870	0720		0873	0723			
600	Gsf 600 Bandit (Pinza Dx)	00>04	1250	0720		1253	0723			
600	Gsf 600 Bandit (Pinza Sx)	00>04	1240	0720		1243	0723			
600	Gsr 600	06>	1150	3060		1153	3063			
600	Gsx 600 F (Pinza Dx)	98>	1250	0720		1253	0723			
600	Gsx 600 F (Pinza Sx)	98>	1240	1243						
600	Gsx 600 F Katana	88>93	0720				0723			
600	Gsx-R 600	04>05	2963				3113			
600	Gsx-R 600	06>10	3060		2963			3063		
600	Gsx-R 600	11>	2923				2933			
600	Gsx-R 600	>93	3030	0720		3033	0723			
600	Gsx-R 600 F	94>95	0870	0873						
600	Gsx-R 600 V	96>03	1150	1153						
600	Rf 600 Rr	93>	0870	0873						
650	An 650 Burgman	03>09	0870	1500		0873	1503			
650	DI 650 V Strom (Pinza Dx)	04>	1250	0930		1253	0933			

PASTIGLIE FRENO RMS - SINTER (RICERCA PER MARCA)

RMS - SINTER BRAKE PADS (SEARCH BY BRAND)

















CC	MODELLO MODEL	ANNO YEAR	RMS YOUR BEST PARTNER				SINTER	
			 ANTERIORE - FRONT		 POSTERIORE - REAR		 ANTERIORE FRONT	 POSTERIORE REAR
			PASTIGLIA ORGANICA - ORGANIC				PASTIGLIA SINTERIZZATA SINTERED	
								
			OMOLOGATA HOMOLOGATED	NON OMOLOGATA NOT HOMOLOGATED	GANASCE BRAKE SHOES	OMOLOGATA HOMOLOGATED	NON OMOLOGATA NOT HOMOLOGATED	GANASCE BRAKE SHOES
22 510		22 512	22 510		22512	22 510	22 510	
650	DI 650 V Strom (Pinza Sx)	04>	1240		0930		1243	0933
650	Dr 650 Se	96>	0920		2630		0923	2633
650	Gsf 650 Bandit (Pinza Dx)	05>	1250		3110		1253	3113
650	Gsf 650 Bandit (Pinza Sx)	05>	1240		3110		1243	3113
650	Gsf 650 Bandit (Pinza Dx)	06>	1250		0930		1253	0933
650	Gsf 650 Bandit (Pinza Sx)	06>	1240		0930		1243	0933
650	Gsf 650 Bandit Abs	07>	1150		0930		1153	0933
650	Gsf 650 S Bandit Abs	07>	1150		0930		1153	0933
650	Gsx 650 F	08>	1150		0930		1153	0933
650	Sfv 650 Gladius (Pinza Dx)	09>	1250		0930		1253	0933
650	Sfv 650 Gladius (Pinza Sx)	09>	1240		0930		1243	0933
650	Sv 650 S (Pinza Dx)	99>02	1250		0720		1253	0723
650	Sv 650 S (Pinza Sx)	99>02	1240		0720		1243	0723
650	Sv 650 S (Pinza Dx)	03>	1250		0930		1253	0933
650	Sv 650 S (Pinza Sx)	03>	1240		0930		1243	0933
650	Xf 650 Freewind	97>	1250		0930		1253	0933
750	Gsr 750 (Pinza Dx)	11>	1240		0930		1243	0933
750	Gsr 750 (Pinza Sx)	11>	1240		0930		1243	0933
750	Gsx 750 Ef	87>			0720			0723
750	Gsx 750 F	89>			0720			0723
750	Gsx 750 F	90>91	1150		0720		1153	0723
750	Gsx 750 F	93>97			0720			0723
750	Gsx 750 F (Pinza Dx)	98>03	1250		0720		1253	0723
750	Gsx 750 F (Pinza Sx)	98>03	1240		0720		1243	0723
750	Gsx 750 Fk	88>			0720			0723
750	Gsx 750 Limited Edition	86>			0720			0723
750	Gsx F 750	08>09	1150		0930		1153	0933
750	Gsx R 750	85>87			0720			0723
750	Gsx R 750	88>93	3030				3033	
750	Gsx R 750	04>05					2963	3113
750	Gsx R 750	06>10			3060		2963	3063
750	Gsx R 750 Ltd Special Edition	87>88			0720			0723
750	Gsx R 750 W	94>99	1170		0720		1173	0723
750	Gsx R 750 Y	00>03	1150				1153	
750	Gsx-R 750	11>					2923	2933
750	Gt 750 Rf	85>			0720			0723
800	Dr 800 Big All Models	91>			1070			1073
800	M 800 Intruder	05>	1250				1253	



PASTIGLIE FRENO RMS - SINTER (RICERCA PER MARCA)















RMS - SINTER BRAKE PADS (SEARCH BY BRAND)

CC	MODELLO MODEL	ANNO YEAR								
			 ANTERIORE - FRONT		 POSTERIORE - REAR		 ANTERIORE FRONT	 POSTERIORE REAR		
			PASTIGLIA ORGANICA - ORGANIC				PASTIGLIA SINTERIZZATA SINTERED			
			 OMOLOGATA HOMOLOGATED	 NON OMOLOGATA NOT HOMOLOGATED	 GANASCE BRAKE SHOES	 OMOLOGATA HOMOLOGATED	 NON OMOLOGATA NOT HOMOLOGATED	 GANASCE BRAKE SHOES		
			22 510		22 512	22 510		22512	22 510	22 510
800	VI 800 Intruder Lc Volusia	01>04	1250				1253			
800	Vx 800	90>92			0720			0723		
800	Vz 800 Marauder	97>04	1250				1253			
900	Rf 900 Rr	94>	3030				3033			
900	Rf 900 Rt - Rv	96>	3030			0720	3033	0723		
1000	DI 1000 V Strom (Pinza Dx)	02>09	1250			0930	1253	0933		
1000	DI 1000 V Strom (Pinza Sx)	02>09	1240			0930	1243	0933		
1000	Gsx 1000 G Left	96>	1240				1243			
1000	Gsx 1000 G Right	96>	1250				1253			
1000	Gsx R 1000	01>02	1170				1173	3113		
1000	Gsx R 1000	03>					2983	3113		
1000	Gsx R 1000	04>06					2963	3113		
1000	Gsx R 1000	07>08			3060		2963	3063		
1000	Gsx R 1000	09>11					2963	2933		
1000	Gsx R 1000	11>					2923	2933		
1000	Sv 1000	03>05	1150			0930	1153	0933		
1000	Sv 1000	06>07	1150			0930	1153	0933		
1000	TI 1000 Rw	98>02	1170			0720	1173	0723		
1000	TI 1000 Sv Twin	97>01	1150				1153			
1100	Gsx 1100 F	93>	3030				3033			
1100	Gsx 1100 G (Pinza Dsx)	96>	1240			0720	1243	0723		
1100	Gsx 1100 G (Pinza Dx)	96>	1250			0720	1253	0723		
1100	Gsx R 1100	85>88				0720		0723		
1100	Gsx R 1100 K - L - M	89>92	3030			0720	3033	0723		
1100	Gsx R 1100 W	93>	1170				1173			
1200	Gs 1200 Ss K1	01>	1170				1173			
1200	Gsf 1200 Bandit	95>00	3030			0720	3033	0723		
1200	Gsf 1200 Bandit	01>05	1170			0720	1173	0723		
1200	Gsf 1200 Bandit	06>	1150			0930	1153	0933		
1200	Gsf 1200 S Bandit	01>05	1170			0720	1173	0723		
1200	Gsf 1200 S Bandit	06>	1150			0930	1153	0933		
1200	Gsx 1200	99>01	1100			0720	1103	0723		
1250	Gsf 1250 Bandit Abs	07>08	1150			0930	1153	0933		
1250	Gsf 1250 S Bandit Abs	07>08	1150			0930	1153	0933		
1250	Gsx 1250 Fa	10>	1150			0930	1153	0933		
1300	Gsx 1300 B King	07>				0930	2943	0933		
1300	Gsx 1300 B King	08>				3060	2993	3063		
1300	Gsx R 1300 Falcon	99>	1170			0720	1173	0723		

PASTIGLIE FRENO RMS - SINTER (RICERCA PER MARCA)

RMS - SINTER BRAKE PADS (SEARCH BY BRAND)

















CC	MODELLO MODEL	ANNO YEAR								
			 ANTERIORE - FRONT			 POSTERIORE - REAR			 ANTERIORE FRONT	 POSTERIORE REAR
			PASTIGLIA ORGANICA - ORGANIC						PASTIGLIA SINTERIZZATA SINTERED	
			 OMOLOGATA HOMOLOGATED	 NON OMOLOGATA NOT HOMOLOGATED	 GANASCE BRAKE SHOES	 OMOLOGATA HOMOLOGATED	 NON OMOLOGATA NOT HOMOLOGATED	 GANASCE BRAKE SHOES		
			22 510		22 512	22 510		22512	22 510	22 510
1300	Gsx R 1300 Hayabusa	99>07	1170			0720		1173	0723	
1300	Gsx R 1300 Hayabusa	08>				3060		2963	3063	
1400	Gsx 1400	01>06	1170					1173	3113	
1400	Gv 1400	85>86				0040				
1400	Vs 1400 Glpt/Glpv	96>	1150			1440		1153		
1500	C 1500 Intruder (Pinza Dx)	05>	1250					1253		
1500	C 1500 Intruder (Pinza Sx)	05>	1240					1243		
1500	M 1500 Intruder (Pinza Dx)	09>	1250			1250		1253	1253	
1500	M 1500 Intruder (Pinza Sx)	09>	1240			1250		1243	1253	
1500	VI 1500 Intruder (Pinza Dx)	02>	1250					1253		
1500	VI 1500 Intruder (Pinza Sx)	02>	1240					1243		
1600	M 1600 Intruder	05>				1250		2983	1253	
1600	Vz 1600 Marauder	04>	1170			1250		1173	1253	
1800	C 1800 R Intruder	08>	2540	2550 Con piastra		1250		2543	1253	
1800	M 1800 R Intruder	06>				1250		2963	1253	
1800	M 1800 R2 Intruder	08>				1250		2963	1253	
SUZUKI ATV										
230	Lt 230 Eh/Ej/Ek/El/Em/En/Ep	86>93				2850			2853	
250	Lt 250 Sk/SI	89>90				2850			2853	
250	Lt-Z 250 Quad Sport	04>	1440							
250	Ozark 250	03>	1440							
300	Lt-F 300 King Quad (Pinza Dx)	02>	1070					1073		
300	Lt-F 300 King Quad (Pinza Sx)	02>	1420					1423		
400	Lt-F 400 Eiger	02>	1440							
400	Lt-Z 400 Quad Sport	02>	1440							
450	Lt-A 450 (Pinza Dx)	07>	2900					2903		
450	Lt-A 450 (Pinza Sx)	07>	2880					2883		
500	Lt-A 500 F Quadmaster (Pinza Dx)	00>	1070					1073		
500	Lt-A 500 F Quadmaster (Pinza Sx)	00>	1420					1423		
500	Lt-A 500 F Vinson	02>	1440							
500	Lt-F 500 F Quadrunner (Pinza Dx)	98>00	1070					1073		
500	Lt-F 500 F Quadrunner (Pinza Sx)	98>00	1420					1423		
700	King Quad 700 (Pinza Dx)	05>	2890					2893		
700	King Quad 700 (Pinza Sx)	05>	2870					2873		
700	Lt-A 700 Kingquad (Pinza Dx)	06>07	2900					2903		
700	Lt-A 700 Kingquad (Pinza Sx)	06>07	2880					2883		
SWM										
125	S1 125	83>	0010					0013		



PASTIGLIE FRENO RMS - SINTER (RICERCA PER MARCA)

RMS - SINTER BRAKE PADS (SEARCH BY BRAND)

CC	MODELLO MODEL	ANNO YEAR								
			 ANTERIORE - FRONT		 POSTERIORE - REAR		 ANTERIORE FRONT	 POSTERIORE REAR		
			PASTIGLIA ORGANICA - ORGANIC				PASTIGLIA SINTERIZZATA SINTERED			
			 OMOLOGATA HOMOLOGATED	 NON OMOLOGATA NOT HOMOLOGATED	 GANASCE BRAKE SHOES	 OMOLOGATA HOMOLOGATED	 NON OMOLOGATA NOT HOMOLOGATED	 GANASCE BRAKE SHOES		
			22 510		22 512	22 510		22512	22 510	22 510
125	S2 125	83>	0010				0013			
250	S1 250	83>	0010				0013			
250	S2 250	83>	0010				0013			
350	Xp 350 Sahara	83>	3150				3153			
SYM										
50	Alpha 50	95>	2750				2753			
50	Alto 50	11>	2750				2753			
50	Bullet	93>	1650							
50	Cinderella 50	01>	1650							
50	Cinderella 50	99>	3240	0140			0091			
50	City Hopper 50	99>	3240	0140			0091			
50	Fancy 50	95>	3240	0140			0091			
50	Fiddle 50	99>	0091							
50	Fiddle li 50	08>09	2750				2753			
50	Jet 4 50	09>10	2750				2753			
50	Jet 4 50 Naked	11>	2750				2753			
50	Jet 4R 50	11>	2750				2753			
50	Jet 50	95>	2750				2753			
50	Jet 50 All Models	05>08	2750				2753			
50	Jet 50 Sport X	06>10	2750				2753			
50	Jungle 50	96>	2750				0091	2753		
50	Mask 50	00>	2750				0091	2753		
50	Mask 50 Lc	00>	2750				0091	2753		
50	Mio	05>	1650							
50	Red Devil 50	99>	2750				0091	2753		
50	Super Fancy 50	95>97	2750				0091	2753		
50	Super Fancy 50	99>	3240	0140			0091			
50	Symphony 50	09>	2750				2753			
50	Symphony 50 S	10>	2750				2753			
50	Symphony 50 Sr	10>	2750				2753			
50	Symply li 50	07>09	2750				2753			
50	Rs	05	3260							
50	Rs 21	02	3260							
100	Cinderella 100	01>	1650							
100	Cinderella 100	99>	3240	0140			0091			
100	Jet 100	99>	2750				2753			
100	Jet 100 Euro X	05>	2750				2753			
100	Mio	05>	1650							

PASTIGLIE FRENO RMS - SINTER (RICERCA PER MARCA)

RMS - SINTER BRAKE PADS (SEARCH BY BRAND)

















CC	MODELLO MODEL	ANNO YEAR	RMS YOUR BEST PARTNER				SINTER	
			ANTERIORE - FRONT		POSTERIORE - REAR		ANTERIORE FRONT	POSTERIORE REAR
			PASTIGLIA ORGANICA - ORGANIC				PASTIGLIA SINTERIZZATA SINTERED	
			OMOLOGATA HOMOLOGATED	NON OMOLOGATA NOT HOMOLOGATED	GANASCE BRAKE SHOES	OMOLOGATA HOMOLOGATED	NON OMOLOGATA NOT HOMOLOGATED	GANASCE BRAKE SHOES
22 510		22 512	22 510		22512	22 510	22 510	
100	Party 100	97>	2750				2753	
100	Super Fancy 100	95>	2750				0091	2753
100	Super Fancy 100	99>	3240	0140			0091	
110	Star 110	03>	2750				2753	
125	Attila 125	95>	2750				2753	
125	Attila 125	99>00	2750				2753	
125	Fiddle li 125	08>10	2750				2753	
125	Gts 125	07>	0380				0383	
125	Hd 125	04>	2710					
125	Hd 125	05>06					3230	
125	Hd 125 Evo Eu3	08>10	2750				2753	
125	Hd 125 Evo Eu3	10>					3230	
125	Husky 125	96>98	1200					
125	Jet 4 125	09>	2750				2753	
125	Joy Ride 125	01>04					2710	
125	Joy Ride 125 Eu2	05>06					3230	
125	Joy Ride 125 Eu3	07>					3230	
125	Joy Ride 125 Evo	10>					3230	
125	Megalo 125	02>07	2750				2753	
125	New Duke 125	00>01	2750				2753	
125	Rs 125	05>					0350	0353
125	Rs 21 125	02>					0350	0353
125	Shark 125	00>					0350	0353
125	Super Duke 125	95>	2750				2753	
125	Super Duke 125	99>02	2750				0091	2753
125	Symphony 125	09>	2750				2753	
125	Symphony 125 D.d.	09>	2750				2753	
125	Symphony 125 S	10>	2750				2753	
125	Symphony 125 Sr	10>	2750				2753	
125	Symply 125	07>08	2750				2753	
125	Symply li 125	09>10	2750				2753	
125	Voyager 125	05>	0500					
125	Wolf Classic 125	05>	2590				2593	
125	Wolf Legend 125	02>	2590				2593	
125	Eu Mx	03	3260					
125	Joyride	01-04	3260					
125	Rs	05	3260					
125	Rs 21	02	3260					



PASTIGLIE FRENO RMS - SINTER (RICERCA PER MARCA)

RMS - SINTER BRAKE PADS (SEARCH BY BRAND)

CC	MODELLO MODEL	ANNO YEAR								
			 ANTERIORE - FRONT		 POSTERIORE - REAR		 ANTERIORE FRONT	 POSTERIORE REAR		
			PASTIGLIA ORGANICA - ORGANIC				PASTIGLIA SINTERIZZATA SINTERED			
			 OMOLOGATA HOMOLOGATED	 NON OMOLOGATA NOT HOMOLOGATED	 GANASCE BRAKE SHOES	 OMOLOGATA HOMOLOGATED	 NON OMOLOGATA NOT HOMOLOGATED	 GANASCE BRAKE SHOES		
			22 510	22 512	22 510	22512	22 510	22 510		
125	Shark	00-02	3260							
150	Attila 150	00>01	2750				2753			
150	Fiddle li 150	10>	2750				2753			
150	H01 150	95>	2750				2753			
150	Joy Ride 150	01>02	2710							
150	Rs 150	05>	0350					0353		
150	Super Duke 150	96>	2750				2753			
150	Super Duke 150	99>02	2750				2753			
150	Symphony 150	09>	2750				2753			
150	Symphony 150 S	10>	2750				2753			
150	Symphony 150 Sr	10>	2750				2753			
150	Eu Mx	03	3260							
150	Joyride	01-02	3260							
150	Rs	05	3260							
180	Mf 180	03>	2590				2593			
200	Hd 200	04>	2710							
200	Hd 200 Evo Eu2	05>06	3230							
200	Hd 200 Evo i Eu3	07>	2750				3230	2753		
200	Hd 200 Evo i Eu3	10>	2750				3230	2753		
200	Joy Ride 200	01>04	2710							
200	Joy Ride 200 Eu2	05>06	3230							
200	Joy Ride 200 i Eu3	07>09	3230							
200	Joy Ride 200 i Evo	10>	3230							
200	Joyride	01-04	3260							
250	Gts 250	07>	0380				3230	0383		
250	Joy Max 250	06>07	0500				3230			
250	Voyager 250	05>	0500							
300	Citycom 300	08>09	2750				2750	2753 2753		
300	Citycom 300 Efi	10>	2750				2750	2753 2753		
300	Gts 300	09>	0380					0383		
300	Joy Max 300 Evo	09>	3230							
300	Joy Max 300 Evo i	10>	3230							
400	Maxsym 400 i	11>	2830					2833		
500	Gt 500	07>	0380				2710	0383		
SYM ATV										
180	Track Runner 180	06>07	3230							
250	Quad Lander 250	06>07	3230							

PASTIGLIE FRENO RMS - SINTER (RICERCA PER MARCA)

RMS - SINTER BRAKE PADS (SEARCH BY BRAND)

















CC	MODELLO MODEL	ANNO YEAR	RMS YOUR BEST PARTNER				SINTER	
			ANTERIORE - FRONT		POSTERIORE - REAR		ANTERIORE FRONT	POSTERIORE REAR
			PASTIGLIA ORGANICA - ORGANIC				PASTIGLIA SINTERIZZATA SINTERED	
			OMOLOGATA HOMOLOGATED	NON OMOLOGATA NOT HOMOLOGATED	GANASCE BRAKE SHOES	OMOLOGATA HOMOLOGATED	NON OMOLOGATA NOT HOMOLOGATED	GANASCE BRAKE SHOES
22 510		22 512	22 510		22512	22 510	22 510	
TGB								
50	203 50	02>	0040					
50	203 50	05>	0580			0583		
50	303 R 50	99>	0040					
50	Akros 50	99>	0040					
50	Akros 50 Tec 5	99>	0580			0583		
50	Apollo 50	99>	0580			0583		
50	Ergon 50	96>	0040					
50	Fire 50	03>	0580			0583		
50	Hiw's 50	99>	0040					
50	Sky 50	03>	0580			0583		
50	Trigger 50	99>	0040					
90	101 S 90	99>	0040					
90	202 S 90	99>	0040					
90	Akros 90	99>	0040					
90	Apollo 90	99>	0580			0583		
90	Ergon 90	99>	0040					
90	Hiw's 90	99>	0040					
90	Trigger 90	99>	0040					
125	101 S 125	99>	0040					
125	202 T 125	99>	0040					
125	303 R 125	99>	0040					
309	309 Racing	05>	0040					
309	309 Rs	00>	0040					
507	507	05>	0040					
	Buffalo	03>			0350		0353	
	Bunny	97>	0040					
	Double X	05>	0040					
TM								
80	All Models 80	90>93			1200			
80	All Models 80	94>	0430		1330		1333	
80	All Models 80	>85	0010			0013		
80	Cross 80	96>00			1330		1333	
80	Gs 80	86>89			0010		0013	
80	Junior 80	96>00	0040		2850		2853	
80	Mc 80	86>89			0010		0013	
125	All Models 125	90>93			1200			
125	All Models 125	94>95	0430		1330		1333	
125	All Models 125	96>00	0430		1330		1333	



PASTIGLIE FRENO RMS - SINTER (RICERCA PER MARCA)

RMS - SINTER BRAKE PADS (SEARCH BY BRAND)

CC	MODELLO MODEL	ANNO YEAR								
			 ANTERIORE - FRONT		 POSTERIORE - REAR		 ANTERIORE FRONT	 POSTERIORE REAR		
			PASTIGLIA ORGANICA - ORGANIC				PASTIGLIA SINTERIZZATA SINTERED			
			 OMOLOGATA HOMOLOGATED	 NON OMOLOGATA NOT HOMOLOGATED	 GANASCE BRAKE SHOES	 OMOLOGATA HOMOLOGATED	 NON OMOLOGATA NOT HOMOLOGATED	 GANASCE BRAKE SHOES		
			22 510	22 512	22 510	22512	22 510	22 510		
125	All Models 125	01>04	0430		2630			2633		
125	All Models 125	05>	0430		1450			1453		
125	All Models 125	>85	0010				0013			
125	Cross - Enduro 125	89>90	0530				0533			
125	Cross - Enduro 125	91>95	0530		1330		0533	1333		
125	Cross 80	96>00	0430							
125	Gs 125	86>89			0010			0013		
125	Mc 125	86>89			0010			0013		
125	Smr 125	05>	0520		2630		0523	2633		
250	250 E	95>00	0430		1330			1333		
250	250 F	01>04	0430		2630			2633		
250	250 F	05>	0430		1450			1453		
250	All Models 250	95>00	0430		1330			1333		
250	All Models 250	01>04	0430		2630			2633		
250	All Models 250	05>	0430		1450			1453		
250	Enduro 250 F	00>	0430		1330			1333		
250	Enduro 250 F	01>04	0430		2630			2633		
250	Enduro 250 F	05>	0430		1450			1453		
300	All Models 300	98>00	0430		1330			1333		
300	All Models 300	01>04	0430		2630			2633		
300	All Models 300	05>	0430		1450			1453		
320	All Models 320	96>97	0430		1330			1333		
400	400 F	00>	0430		1330			1333		
400	All Models 400 4T	01>	0430		2630			2633		
400	Smf 400 F	02>	0520		2630		0523	2633		
400	Smr 400 F	03>	0520		2630		0523	2633		
450	All Models 450 F	02>04	0430		2630			2633		
450	All Models 450 F	05>	0430		1450			1453		
450	Smr 450 F	04>	0520		2630		0523	2633		
450	Smx 450 F	03>	0520		2630		0523	2633		
450	Smx 450 F	04>	2860		2630		2863	2633		
530	All Models 530 F	01>04	0430		2630			2633		
530	All Models 530 F	05>	0430		1450			1453		
530	Smr 530 F	03>	0520		2630		0523	2633		
600	Smx 600 F	03>	0520		2630		0523	2633		
600	Smx 660 F	04>			2630			2633		
660	Smx 660 F	04>	2860				2863			

PASTIGLIE FRENO RMS - SINTER (RICERCA PER MARCA)

RMS - SINTER BRAKE PADS (SEARCH BY BRAND)

















CC	MODELLO MODEL	ANNO YEAR	RMS YOUR BEST PARTNER				SINTER	
			ANTERIORE - FRONT		POSTERIORE - REAR		ANTERIORE FRONT	POSTERIORE REAR
			PASTIGLIA ORGANICA - ORGANIC				PASTIGLIA SINTERIZZATA SINTERED	
			OMOLOGATA HOMOLOGATED	NON OMOLOGATA NOT HOMOLOGATED	GANASCE BRAKE SHOES	OMOLOGATA HOMOLOGATED	NON OMOLOGATA NOT HOMOLOGATED	GANASCE BRAKE SHOES
22 510		22 512	22 510		22512	22 510	22 510	
TOMOS								
50	Bt 50 S	89>	0030					
50	Mc 50 Senjor Pro	04>	3210		3210			
50	N 50 At, Bt	91>	0030					
50	Revival 50	02>	0190				0193	
50	Se 50	05>	0740		0080			0083
50	Streetmate 50	03>	0190				0193	
80	City 80	89>	0030					
83	K 83	-		0191			0191	
83	M 83	-		0191			0191	
125	Se 125	05>	0740		0080			0083
TORNAX								
80	Rx 80	-	0010				0013	
TRESOLDI								
80	Cr 80	85>	0010		0030		0013	
TRIUMPH								
600	Daytona 600	04>	3030		2610		3033	2613
600	Speed Four 600	03>	3030		2610		3033	2613
600	Tt 600	00>03	3030		2610		3033	2613
650	Daytona 650	05>	3030		2610		3033	2613
675	Daytona 675	06>08			2610		2993	2613
675	Daytona R Triple 675	11>			2610		2923	2613
675	Daytona Triple 675	09>			2610			2613
675	Street Triple 675	08>	0870		2610		0873	2613
675	Street Triple R 675	09>			2610		2993	2613
675	Daytona R (Pinze radiali - Rad.cal)	11-13					3333	
750	Bonneville 750 Uk	87>	3150		3150		3153	3153
750	Daytona 750	91>92	3030				3033	
750	Trident 750 (Pinza Dx)	91>	1070		1070		1073	1073
750	Trident 750 (Pinza Sx)	91>	1420		1070		1423	1073
800	America 800	03>06	0870		1420		0873	1423
800	Bonneville 800	01>04	0870		1420		0873	1423
800	Bonneville 800 America	02>	0870		1420		0873	1423
800	Bonneville 800 T 100 Paul Smith	06>08	0870		1420		0873	1423
800	Bonneville 800 T100 Centennial Edition	02>04	0870		1420		0873	1423
800	Speedmaster 800	03>04	0870		1420		0873	1423
800	Tiger 800	11>	0870		2610		0873	2613



PASTIGLIE FRENO RMS - SINTER (RICERCA PER MARCA)

RMS - SINTER BRAKE PADS (SEARCH BY BRAND)

CC	MODELLO MODEL	ANNO YEAR	 YOUR BEST PARTNER							
			 ANTERIORE - FRONT		 POSTERIORE - REAR		 ANTERIORE FRONT	 POSTERIORE REAR		
			PASTIGLIA ORGANICA - ORGANIC				PASTIGLIA SINTERIZZATA SINTERED			
			 OMOLOGATA HOMOLOGATED	 NON OMOLOGATA NOT HOMOLOGATED	 GANASCE BRAKE SHOES	 OMOLOGATA HOMOLOGATED	 NON OMOLOGATA NOT HOMOLOGATED	 GANASCE BRAKE SHOES		
			22 510		22 512	22 510		22512	22 510	22 510
800	Tiger 800 Xc	11>	0870		2610		0873	2613		
900	Adventurer 900	96>	0870		2640	0890	0873	2643		
900	America 900	07>	0870		1420		0873	1423		
900	Bonneville 900	05>08	0870		1070		0873	1073		
900	Bonneville 900	09>	0870		1420		0873	1423		
900	Bonneville 900 Se	09>	0870		1420		0873	1423		
900	Bonneville 900 T100	05>08	0870		1070		0873	1073		
900	Bonneville 900 T100	09>	0870		1420		0873	1423		
900	Daytona 900	91>94	3030				3033			
900	Daytona Sprint 900	94>	3030		1070		3033	1073		
900	Daytona Sprint 900 (Pinza Dx)	93>	1420		1070		1423	1073		
900	Daytona Sprint 900 (Pinza Sx)	93>	1070		1070		1073	1073		
900	Legend 900 Tt	99>	0870		2640	0890	0873	2643		
900	Scrambler 900	06>	0870		1420		0873	1423		
900	Speed Triple 900	94>	3030		1070		3033	1073		
900	Speed Triple 900 T509	97>98	3030		1420		3033	1423		
900	Speedmaster 900	05>	0870		1420		0873	1423		
900	Thruxton 900	04>	0870		1420		0873	1423		
900	Thunderbird 900	96>	0870		2640	0890	0873	2643		
900	Thunderbird 900 Sport	03>	0870		2640	0890	0873	2643		
900	Tiger 900	99>00	0870		2640	0890	0873	2643		
900	Tiger 900 (Pinza Dx)	93>98	1070		1420		1073	1423		
900	Tiger 900 (Pinza Sx)	93>98	1420		1420		1423	1423		
900	Trident 900 (Pinza Dx)	91>	1070		1420		1073			
900	Trident 900 (Pinza Sx)	91>	1420		1420		1423	1423		
900	Trophy 900	96>	3030				3033			
900	Trophy 900 (Pinza Dx)	91>95	1070		1420		1073	1423		
900	Trophy 900 (Pinza Sx)	91>95	1420		1420		1423	1423		
950	Daytona 950 T595	95>98	3030		1420		3033	1423		
955	Daytona 955	99>	3030		1420		3033	1423		
955	Daytona 955 Centennial	02>	3030		1420		3033	1423		
955	Speed Triple 955	99>	3030		1420		3033	1423		
955	Sprint Rs 955	00>	3030		1420		3033	1423		
955	Sprint St 955	99>04	3030		1420		3033	1423		
955	Tiger 955	01>04	0870		2640	0890	0873	2643		
955	Tiger 955	05>06	0870		1070		0873	1073		
1000	Daytona 1000	91>95	3030				3033			
1000	Trophy 1000 (Pinza Dx)	91>95	1070		1420		1073	1423		

PASTIGLIE FRENO RMS - SINTER (RICERCA PER MARCA)

RMS - SINTER BRAKE PADS (SEARCH BY BRAND)

















CC	MODELLO MODEL	ANNO YEAR	RMS YOUR BEST PARTNER				SINTER	
			ANTERIORE - FRONT		POSTERIORE - REAR		ANTERIORE FRONT	POSTERIORE REAR
			PASTIGLIA ORGANICA - ORGANIC				PASTIGLIA SINTERIZZATA SINTERED	
			OMOLOGATA HOMOLOGATED	NON OMOLOGATA NOT HOMOLOGATED	GANASCE BRAKE SHOES	OMOLOGATA HOMOLOGATED	NON OMOLOGATA NOT HOMOLOGATED	GANASCE BRAKE SHOES
22 510		22 512	22 510		22512	22 510	22 510	
1000	Trophy 1000 (Pinza Sx)	91>95	1420		1420		1423	1423
1050	Speed Triple 1050	05>07			1420		2993	1423
1050	Speed Triple 1050	08>	2860		1420		2863	1423
1050	Sprint Gt 1050 Abs	11>	3030		1420		3033	1423
1050	Sprint St 1050	05>	3030		1420		3033	1423
1050	Tiger 1050	07>			1070		2993	1073
1050	Tiger Se 1050	09>			1070		2993	1073
1200	Daytona 1200	91>	3030				3033	
1200	Trophy 1200	96>03	3030				3033	
1200	Trophy 1200 (Pinza Dx)	91>95	1070		1420		1073	1423
1200	Trophy 1200 (Pinza Sx)	91>95	1420		1420		1423	1423
1600	Thunderbird 1600	09>	3030		1010		3033	1013
1600	Thunderbird 1600 Storm	11>	3030		1010		3033	1013
2300	Rocket Iii 2300	04>	3030		1010		3033	1013
2300	Rocket Iii 2300 Classic	07>	3030		1010		3033	1013
2300	Rocket Iii 2300 Roadter	10>	3030		1010		3033	1013
UVM								
50	Be There 50	99>	0040					
50	Bingo 50	99>	0040					
125	Be There 125	99>	0040					
125	Bingo 125	99>	0040					
125	Paragon 125	99>	0040					
VERTEMATI								
450	C 450 Cross	03>	0430		1330			1333
450	E 450 Enduro	02>	0430		1330			1333
450	Sr 450 Motard	03>	1150		1330		1153	1333
450	Sr 450 Motard Racing	03>	1150		1330		1153	1333
500	C 500 Cross	>02	0430		1330			1333
501	E 501 Enduro	03>	0430		1330			1333
501	S 501 Motard	02>	1150		1330		1153	1333
570	C 570 Cross	03>	0430		1330			1333
570	E 570 Enduro	03>	0430		1330			1333
600	Sr 600 Motard Racing	03>	1150		1330		1153	1333
VICTORY								
1500	Kingpin 1500	04>05	1100		1010		1103	1013
1500	Touring Cruiser 1500	03>06	1100		1010		1103	1013
1500	V92c Cruiser 1500	98>02	1100		1010		1103	1013
1500	V92c Deluxe 1500	01>02	1100		1010		1103	1013



PASTIGLIE FRENO RMS - SINTER (RICERCA PER MARCA)











RMS - SINTER BRAKE PADS (SEARCH BY BRAND)

CC	MODELLO MODEL	ANNO YEAR								
			 ANTERIORE - FRONT		 POSTERIORE - REAR		 ANTERIORE FRONT	 POSTERIORE REAR		
			PASTIGLIA ORGANICA - ORGANIC				PASTIGLIA SINTERIZZATA SINTERED			
			 OMOLOGATA HOMOLOGATED	 NON OMOLOGATA NOT HOMOLOGATED	 GANASCE BRAKE SHOES	 OMOLOGATA HOMOLOGATED	 NON OMOLOGATA NOT HOMOLOGATED	 GANASCE BRAKE SHOES		
			22 510		22 512	22 510		22512	22 510	22 510
1500	V92sc Sport Cruise 1500	00>02	1100		1010		1103	1013		
1500	Vegas 1500	03>05	1100		1010		1103	1013		
1500	Vegas 8-Ball 1500	05>	1100		1010		1103	1013		
1634	Hammer 1634	05>07	1100		1010		1103	1013		
1634	Hammer 1634	08>	3030		2640	0890	3033	2643		
1634	Hammer S 1634	06>08	1100		1010		1103	1013		
1634	Kingpin 1634	06>07	1100		1010		1103	1013		
1634	Kingpin 1634 All Models	08>	3030		2640	0890	3033	2643		
1634	Kingpin Tour 1634	06>07	1100		1010		1103	1013		
1634	Vegas 1634	06>07	1100		1010		1103	1013		
1634	Vegas 1634	08>	3030		2640	0890	3033	2643		
1634	Vegas 8 Ball 1634	06>07	1100		1010		1103	1013		
1634	Vegas Jackpot 1634	06>07	1100		1010		1103	1013		
1634	Vegas Jackpot 1634	08>	3030		2640	0890	3033	2643		
1731	Cross Country 1731	10>	0970		2640	0890	0973	2643		
1731	Cross Roads 1731	10>	0970		2640	0890	0973	2643		
1731	Hammer 1731	09>	3030		2640	0890	3033	2643		
1731	Hammer S 1731	09>	3030		2640	0890	3033	2643		
1731	Vegas Jackpot 1731	09>	3030		2640	0890	3033	2643		
1731	Vision 1731 All Models	08>	0970		2640	0890	0973	2643		
VOR										
400	All Models 400	00>	0430		1330			1333		
400	En 400	02>	0430		1330			1333		
450	All Models 450	00>	0430		1330			1333		
450	Sm 450	02>	0520		1330		0523	1333		
492	All Models 492	99>	0430		1330			1333		
492	Supermotard 492	00>	0520		1330		0523	1333		
495	All Models 495	99>	0430		1330			1333		
500	Super Motard 500	00>01	0520		1330		0523	1333		
503	All Models 503	00>	0430		1330			1333		
530	All Models 530	02>	0430		1330			1333		
530	En 530	02>	0430		1330			1333		
530	Mx 530	02>	0430		1330			1333		
530	Sm 530	02>	0520		1330		0523	1333		
VOXAN										
1000	Cafe' Racer 1000	01>	0520		0490		0523	0493		
1000	Roadster 1000	01>	0520		0490		0523	0493		
1000	Scrambler 1000	01>03	0870				0873			

PASTIGLIE FRENO RMS - SINTER (RICERCA PER MARCA)

RMS - SINTER BRAKE PADS (SEARCH BY BRAND)

















CC	MODELLO MODEL	ANNO YEAR	RMS YOUR BEST PARTNER				SINTER	
			 ANTERIORE - FRONT		 POSTERIORE - REAR		 ANTERIORE FRONT	 POSTERIORE REAR
			PASTIGLIA ORGANICA - ORGANIC				PASTIGLIA SINTERIZZATA SINTERED	
								
			OMOLOGATA HOMOLOGATED	NON OMOLOGATA NOT HOMOLOGATED	GANASCE BRAKE SHOES	OMOLOGATA HOMOLOGATED	NON OMOLOGATA NOT HOMOLOGATED	GANASCE BRAKE SHOES
22 510		22 512	22 510		22512	22 510	22 510	
1000	Vb1 1000 Evo	04>	1100	0490		1103	0493	
YAMAHA								
50	50 Axis Profoot	94>	0180			0091		
50	50 Beluga	90>		0051				
50	50 Bw's	92>94		0051		0051		
50	50 Bw's R	95>	0190			0051	0193	
50	50 Fly One	92>	2730	1430				
50	50 Grafix	93>		0051		0051		
50	50 Slider	00>	0280					
50	50 Trafic	93>		0051		0051		
50	50 Trunk	94>	0180			0091		
50	50 Zuma	96>	0190			0051	0193	
50	Bw 50	06>				0480		
50	Bw 50	91>		0051		0051		
50	Bw 50 Bump	97>	0190			0051	0193	
50	Bw 50 Next Generation	96>	0190			0051	0193	
50	Bw 50 Sports Spec R	02>	0190			0051	0193	
50	Bw 50 Spy	95>99	0190			0061	0193	
50	Bws Easy	13>13	0190			0480		
50	Bws Naked	09>13	0190			0480		
50	Cr 50 Target	91>	0180			0061		
50	Cr 50 Z	92>	0180			0061		
50	Ct 50 Super Sport	90>		0061		0061		
50	Cy 50 Jog	90>				0051		
50	Dt 50 R	04>	0360	2810		0363		
50	Dt 50 R	93>	2730	1430		0051		
50	Dt 50 R	98>03	0070			0061		
50	Dt 50 X Supermotard	04>	0360	2810		0363		
50	Ew 50 Slider	00>	0190			0193		
50	Fzr 50	90>91	1070			1073		
50	Fzr 50	92>	1420	1790		1423		
50	Joc 50	90>		0051		0051		
50	Jog 50 (Espana)	88>	0180					
50	Jog 50 (Italia)	93>	0180			0091		
50	Jog 50 R	02>	3210					
50	Jog 50 R	06>12	0190			0480		
50	Jog 50 Z (Italia)	93>	3210			0091		
50	Mini 50 L Shaft	83>				0051		



PASTIGLIE FRENO RMS - SINTER (RICERCA PER MARCA)











RMS - SINTER BRAKE PADS (SEARCH BY BRAND)

CC	MODELLO MODEL	ANNO YEAR								
			 ANTERIORE - FRONT		 POSTERIORE - REAR		 ANTERIORE FRONT	 POSTERIORE REAR		
			PASTIGLIA ORGANICA - ORGANIC				PASTIGLIA SINTERIZZATA SINTERED			
			 OMOLOGATA HOMOLOGATED	 NON OMOLOGATA NOT HOMOLOGATED	 GANASCE BRAKE SHOES	 OMOLOGATA HOMOLOGATED	 NON OMOLOGATA NOT HOMOLOGATED	 GANASCE BRAKE SHOES		
			22 510		22 512	22 510		22512	22 510	22 510
50	Rs 50 Champ	88>	0180							
50	Tdr 50	90>	2730	1430	2730	1430				
50	Tzm 50 R	94>	1070		2730	1430	1073			
50	Tzr 50	03>05	0360		0080		0363	0083		
50	Tzr 50	90>92	1070		2730	1430	1073			
50	Tzr 50	93>02	1070		0080		1073	0083		
50	V 50 M	83>		0051			0051			
50	Why 50	97>	0190				0051	0193		
50	Ya 50 Axis	93>	0180				0091			
50	Ye 50 Zest	92>	3210				0061			
50	Ye 50 Zest	93>	0180							
50	Ym 50 Breeze	94>	0190				0051	0193		
50	Yn 50 Neo's	07>13					0480			
50	Yn 50 Neo's	97>	3210				0061			
50	Yn 50 Neo's 4	09>13	0190				0480			
50	Yn 50 Neo's Easy	13>13	0190				0480			
50	Yq 50 Aerox Lc	97>	3210		0280					
50	Ysr 50	86>					0061			
60	Ysr 60	86>					0061			
80	80 Beluga	>89		0061			0061			
80	80 Beluga	90>		0051						
80	Dt 80 (Espana)	-		0051			0051			
80	Dt 80 Lc (Espana)	89>					0051			
80	Dt 80 Lc2	93>	2730	1430			0451			
80	Pw 80	91>					0051			
80	T 80 Townmate	83>		0051			0051			
80	Ty 80	83>					0061			
80	Tzr 80	92>95	0180		2730	1430				
80	Tzr 80	96>98	1070		2730	1430	1073			
80	V 80	83>		0051			0051			
90	90 Axis (Brasil)	-	0180							
90	Cr 90 Target	91>	0180				0061			
90	Jog 90	90>	0180							
90	Jog 90 (Brasil)	-	0180							
90	Tt-R 90	00>		0061			0061			
90	Ysr 80	86>					0061			
100	Bw' S 100	99>	0180				0451			
100	Rt 100	94>		0061			0061			

PASTIGLIE FRENO RMS - SINTER (RICERCA PER MARCA)

RMS - SINTER BRAKE PADS (SEARCH BY BRAND)

















CC	MODELLO MODEL	ANNO YEAR	RMS YOUR BEST PARTNER				SINTER	
			 ANTERIORE - FRONT		 POSTERIORE - REAR		 ANTERIORE FRONT	 POSTERIORE REAR
			PASTIGLIA ORGANICA - ORGANIC				PASTIGLIA SINTERIZZATA SINTERED	
								
			OMOLOGATA HOMOLOGATED	NON OMOLOGATA NOT HOMOLOGATED	GANASCE BRAKE SHOES	OMOLOGATA HOMOLOGATED	NON OMOLOGATA NOT HOMOLOGATED	GANASCE BRAKE SHOES
22 510		22 512	22 510		22512	22 510	22 510	
100	Rx 100	83>	0051		0051			
100	Yb 100	82>			0061			
100	Yn 100 Neo's	99>02	3210				0451	
100	Yq 100 Aerox	00>02	3210				0451	
100	Yz 100	82>	0061					
105	105 Crypton	98>	2660				0051	2663
125	125 Bikan	91>	0730					
125	Dt 125	84>	0040					
125	Dt 125 (Italia)	86>87	0060					0063
125	Dt 125 Lc / R	88>			2730	1430		
125	Dt 125 R	89>93	2730	1430	2730	1430		
125	Dt 125 R	99>00	2730	1430	2730	1430		
125	Dt 125 Tenere (Italia)	87>	0060					0063
125	Dt 125 Tenere Scout	90>			2730	1430		
125	Dt 125 X Supermotard	05>	1010		1790			1013
125	Hw 125 Xenter	12>	3250					
125	Nxc 125 Cygnus X	04>10	2720					
125	R1 125 (Yzf 125 R)	08>	0430		3070			3073
125	Sr 125 Se	82>92					0061	
125	Td 125 R	93>	2730	1430	2730	1430		
125	Tdr 125	92>			0010			0013
125	Tdr 125	93>	0410		2730	1430		0413
125	Tdr 125 (Italia)	90>91			1200			
125	Tdr 125 R	93>	0400					0403
125	Tt-R 125	00>		0061			0061	
125	Tt-R 125 Lw	00>					0061	
125	Tw 125	98>	2660				0061	2663
125	Ty 250 R	91>93	0080					0083
125	Tz 125	97>	3030					3033
125	Tz 125	98>	3030					3033
125	Tzr 125	90>92	0730					
125	Tzr 125	93>	0410		2730	1430		0413
125	Tzr 125 (Italia)	91>	0520		0010		0523	0013
125	Tzr 125 (Versione Spagna)	87>	1070				1073	
125	Tzr 125 Red Rocket	93>	0520		0010		0523	0013
125	Vp 125 X-City	08>10	0430		0490			0493
125	Wr 125	91>97	1420		1790		1423	
125	Wr 125	98>02	0920		2630		0923	2633



PASTIGLIE FRENO RMS - SINTER (RICERCA PER MARCA)

RMS - SINTER BRAKE PADS (SEARCH BY BRAND)

CC	MODELLO MODEL	ANNO YEAR								
			 ANTERIORE - FRONT		 POSTERIORE - REAR		 ANTERIORE FRONT	 POSTERIORE REAR		
			PASTIGLIA ORGANICA - ORGANIC				PASTIGLIA SINTERIZZATA SINTERED			
			 OMOLOGATA HOMOLOGATED	 NON OMOLOGATA NOT HOMOLOGATED	 GANASCE BRAKE SHOES	 OMOLOGATA HOMOLOGATED	 NON OMOLOGATA NOT HOMOLOGATED	 GANASCE BRAKE SHOES		
			22 510	22 512	22 510	22512	22 510	22 510		
125	Wr 125 R - X	09>	0870		1330			0873	1333	
125	Xc 125 Cygnus R	96>03	2730	1430			0061			
125	Xc 125 Tr Cygnus R	96>	2730	1430			0061			
125	Xc Beluga	90>95					0451			
125	Xc K 125 Cygnus R	97>98	2730	1430			0061			
125	Xc T 125 Cygnus R	95>98					0061			
125	Xn 125 Teos	00>01	0190				0451	0193		
125	Xq 125 Maxter	01>02	0430		0490				0493	
125	Xt 125 R	05>	0080		2810			0083		
125	Xt 125 X Supermotard	05>	0740		2810					
125	Xtz 125	05>	1420					1423		
125	Xv 125 Virago	97>00	0410					0413		
125	Xvs 125 Drag Star	00>04	0410				0451	0413		
125	Ybr 125	05>	2730	1430						
125	Yp 125 Majesty	01>02	0430		0490				0493	
125	Yp 125 Majesty	98>00	0430				0451			
125	Yp E 125 Majesty	03>09	0430		0490				0493	
125	Yp R 125 X-Max	06>09	0770		0490			0773	0493	
125	Yp R 125 X-Max	10>11	2640	0890	0490			2643	0493	
125	Yp R 125 X-Max Abs	11>	2640	0890	2660			2643	2663	
125	Yw 125 Bws	10>	3250							
125	Yz 125	03>07	0920		1450			0923	1453	
125	Yz 125	08>11	2840		1450			2843	1453	
125	Yz 125	88>			2730	1430				
125	Yz 125	89>	1420					1423		
125	Yz 125	98>02	0920		2630			0923	2633	
125	Yz 125 All Models	90>97	1420					1423		
125	Yzf-R 125	08>	0430		3070				3073	
125	Xc Vity	08	3290							
125	Ybr Custom	06-12	3290							
125	Ybr Ed	07-12	3290							
125	Nxc Cygnus	10	3300							
135	T Crypton	06-13	3290							
150	Hw 150 Xenter	12>	3250							
150	Xc 150 Cygnus Gt	90>95	2730	1430			0061			
150	Xc 150 Fly One	90>95	2730	1430						
150	Xc 150 Fly One R	97>98	2730	1430						
150	Xn 150 Teos	01>02	0190					0193		

PASTIGLIE FRENO RMS - SINTER (RICERCA PER MARCA)

RMS - SINTER BRAKE PADS (SEARCH BY BRAND)

















CC	MODELLO MODEL	ANNO YEAR								
			 ANTERIORE - FRONT		 POSTERIORE - REAR		 ANTERIORE FRONT	 POSTERIORE REAR		
			PASTIGLIA ORGANICA - ORGANIC				PASTIGLIA SINTERIZZATA SINTERED			
			 OMOLOGATA HOMOLOGATED	 NON OMOLOGATA NOT HOMOLOGATED	 GANASCE BRAKE SHOES	 OMOLOGATA HOMOLOGATED	 NON OMOLOGATA NOT HOMOLOGATED	 GANASCE BRAKE SHOES		
			22 510	22 512	22 510	22512	22 510	22 510		
150	Xq 150 Maxter	01>02	0430		0490			0493		
150	Yp 150 Majesty	00>	0430							
150	Yp 150 Majesty	01>02	0430		0490			0493		
175	Dt 175	00>	2660				2663			
180	Yp E 180 Majesty	>03	0430							
180	Yp E 180 Majesty	03>06	0430		0490			0493		
200	Dt 200 Wr	91>	1420		1790		1423			
200	Tw 200	01>	2660			0061	2663			
200	Tw 200	87>00				0061				
200	Tw 200	94>	2660				2663			
200	Wr 200 B	91>	1420		1790		1423			
225	Bronco 225	97>	2660				2663			
225	Cellow 225	97>	2660				2663			
225	Serow 225 Xt	85>92	2730	1430		0061				
225	Serow 225 Xt	93>	2730	1430	1790					
225	Ttr 225	01>	2730	1430		0061				
225	Xt 225	01>	2660			0061	2663			
225	Xt 225	92>00	2730	1430		0061				
225	Xt 225 Serow	86>	2730	1430		0061				
250	Fzr 250 R	89>	1060				1063			
250	Fzx 250 Zeal	91>	0400				0403			
250	R1 250 Z	90>					3093			
250	Srv 250 Soulfultwin Renaisa	96>	0400				0403			
250	Tdr 250	88>					3093			
250	Tt 250 R	93>99	1420		1790		1423			
250	Tt-R 250	00>	1420		2630		1423	2633		
250	Ty 250 Z	93>95	0080		0080		0083	0083		
250	Ty 250 Z Scottish	96>	0400		1790		0403			
250	Tz 250	02>	3030				3033			
250	Tz 250	85>					3093			
250	Tz 250 A - Gp	90>01	3030				3033			
250	Tz 250 Competition	88>					3093			
250	Tzr 250	85>89					3093			
250	Tzr 250 R - Sp	91>	1060				1063			
250	Vp 250 X-City	07>11	0430		2660			2663		
250	Wr 250	98>00	0920		2630		0923	2633		
250	Wr 250 Z	91>97	1420		1790		1423			
250	Wr F 250	01>02	0920		2630		0923	2633		



PASTIGLIE FRENO RMS - SINTER (RICERCA PER MARCA)











RMS - SINTER BRAKE PADS (SEARCH BY BRAND)

CC	MODELLO MODEL	ANNO YEAR								
			 ANTERIORE - FRONT		 POSTERIORE - REAR		 ANTERIORE FRONT	 POSTERIORE REAR		
			PASTIGLIA ORGANICA - ORGANIC				PASTIGLIA SINTERIZZATA SINTERED			
			 OMOLOGATA HOMOLOGATED	 NON OMOLOGATA NOT HOMOLOGATED	 GANASCE BRAKE SHOES	 OMOLOGATA HOMOLOGATED	 NON OMOLOGATA NOT HOMOLOGATED	 GANASCE BRAKE SHOES		
			22 510	22 512	22 510	22512	22 510	22 510		
250	Wr F 250	03>11	0920		1450			0923	1453	
250	Wr R 250	08>	0920		2630			0923	2633	
250	Wr X 250	08>	1420		2630			1423	2633	
250	Xg 250 Tricker	05>	2660		1790			2663		
250	Xv 250 S Virago	95>	0410				0451	0413		
250	Xvs 250 Drag Star	01>	0410				0451	0413		
250	Ybr 250	07>	1070					1073		
250	Yd 250 S	91>	0730							
250	Yp 250 Majesty	00>03	0410		2660			0413	2663	
250	Yp 250 Majesty	96>98	0410				0460	0413		
250	Yp 250 Majesty Abs	03>	0410		2660			0413	2663	
250	Yp 250 Majesty Dx	98>99	0410		2660			0413	2663	
250	Yp R 250 X-Max	05>09	0770		2660			0773	0493	
250	Yp R 250 X-Max	10>11	2640	0890	2660			2643	2663	
250	Yp R 250 X-Max Abs	11>	2640	0890	2660			2643	2663	
250	Yp R 250 X-Max Sport	11>	2640	0890	2660			2643	2663	
250	Yz 250	03>07	0920		1450			0923	1453	
250	Yz 250	08>11	2840		1450			2843	1453	
250	Yz 250	88>			2730	1430				
250	Yz 250	89>	1420					1423		
250	Yz 250	90>92	1420		1790			1423		
250	Yz 250	95>97	1420					1423		
250	Yz 250	98>02	0920		2630			0923	2633	
250	Yz 250 Wra/Wrb	90>94	1420		1790			1423		
250	Yz F 250	01>02	0920		2630			0923	2633	
250	Yz F 250	03>06	0920		1450			0923	1453	
250	Yz F 250	07>11	2840		1450			2843	1453	
250	Yp R X-Max	14			3270				3273	
300	Xc 300 Varsity	03>06	0430		0430					
300	Xc 300 Varsity	05>06		0890	0570					
350	Rd 350 Ypvs	83>84			0730					
350	Tt 350	91>			2730	1430				
350	Xt 350	92>	2730	1430			0451			
360	Yz 360	89>	1420					1423		
400	400 Artesia	91>	3200		2730	1430		3203		
400	Fz 400	86>	0730							
400	Fzr 400 R	87>			0730			3093		
400	Fzr 400 Rr - Sp	91>	1060					1063		

PASTIGLIE FRENO RMS - SINTER (RICERCA PER MARCA)

RMS - SINTER BRAKE PADS (SEARCH BY BRAND)

















CC	MODELLO MODEL	ANNO YEAR	RMS YOUR BEST PARTNER				SINTER	
			 ANTERIORE - FRONT		 POSTERIORE - REAR		 ANTERIORE FRONT	 POSTERIORE REAR
			PASTIGLIA ORGANICA - ORGANIC				PASTIGLIA SINTERIZZATA SINTERED	
								
			OMOLOGATA HOMOLOGATED	NON OMOLOGATA NOT HOMOLOGATED	GANASCE BRAKE SHOES	OMOLOGATA HOMOLOGATED	NON OMOLOGATA NOT HOMOLOGATED	GANASCE BRAKE SHOES
22 510		22 512	22 510		22512	22 510	22 510	
400	Srx 400	85>86	0730					
400	Srx 400	87>89				3093		
400	Srx 400	90>			0730			
400	Wr F 400	99>02	0920		2630	0923	2633	
400	Xj 400 Diversion - R	91>94	0410			0413		
400	Xj 400 R	95>	0410		0730	0413		
400	Xvs 400	98>99	0400			0403		
400	Yp 400 Majesty	04>	0400		0800	0403	0803	
400	Yp 400 Majesty	05>06	0410		0800	0413	0803	
400	Yp 400 Majesty	07>11	0410		0800	0413	0803	
400	Yp 400 Majesty Abs	07>11	0410		0800	0413	0803	
400	Yz F 400	98>	0920			0923		
400	Yz F 400	99>	0920		2630	0923	2633	
426	Wr F 426	01>	0920		2630	0923	2633	
426	Yz F 426	99>02	0920		2630	0923	2633	
450	Wr F 450	03>11	0920		1450	0923	1453	
450	Yz F 450	03>07	0920		1450	0923	1453	
450	Yz F 450	08>11	2840		1450	2843	1453	
500	Rd 500 Lc	84>	0730					
500	Rd 500 Ypvs Lc	87>	0730					
500	Wr 500 B	91>	1420		1790	1423		
500	Xp 500 T Max	01>03	0400		1410	0403	1413	
500	Xp 500 T Max	04>07	0410		0800	0413	0803	
500	Xp 500 T Max	08>11	1060		0800	1063	0803	
500	Xp 500 T Max Abs	05>07	0410		0800	0413	0803	
500	Xp 500 T Max Abs	08>11	1060		0800	1063	0803	
500	Xp 500 T Max Sv	11>	1060		0800	1063	0803	
500	Xp 500 T Max Sv Abs	11>	1060		0800	1063	0803	
500	Xt E 500	00>	1420				1423	
530	Xp 530 T-Max	12>	1060		0800	1063	0803	
535	Xv 535 Dx Virago	01>	0400				0403	
535	Xv 535 Virago	95>01	0400				0403	
600	Fz 600	87>	0730					
600	Fz6 600	04>07	0410		0930	0413	0933	
600	Fz6 600 Fazer	04>07	0410		0930	0413	0933	
600	Fz6 600 Fazer Abs	06>07	0410		0930	0413	0933	
600	Fz6 600 Fazer S2	07>08	1060		0930	1063	0933	
600	Fz6 600 Fazer S2 Abs	08>	1060		0930	1063	0933	



PASTIGLIE FRENO RMS - SINTER (RICERCA PER MARCA)











RMS - SINTER BRAKE PADS (SEARCH BY BRAND)

CC	MODELLO MODEL	ANNO YEAR	 YOUR BEST PARTNER							
			 ANTERIORE - FRONT		 POSTERIORE - REAR		 ANTERIORE FRONT	 POSTERIORE REAR		
			PASTIGLIA ORGANICA - ORGANIC				PASTIGLIA SINTERIZZATA SINTERED			
			 OMOLOGATA HOMOLOGATED	 NON OMOLOGATA NOT HOMOLOGATED	 GANASCE BRAKE SHOES	 OMOLOGATA HOMOLOGATED	 NON OMOLOGATA NOT HOMOLOGATED	 GANASCE BRAKE SHOES		
			22 510	22 512	22 510	22512	22 510	22 510		
600	Fz6 600 Ns	05>06	0410		0930		0413	0933		
600	Fz6 600 S2	07>08	1060		0930		1063	0933		
600	Fzr 600	89>	0730		0730					
600	Fzr 600 R	90>			0730					
600	Fzr 600 R	91>			0730					
600	Fzs 600 Fazer	98>	1060				1063			
600	Fzs 600 Sp Fazer	00>03	1060				1063			
600	Srx 600	87>					3093			
600	Tt 600	93>	0430		1790					
600	Tt 600 N	85>88	2730	1430						
600	Tt 600 R	98>	0430		1330			1333		
600	Tt 600 R (Sportkit)	94>97	0430		1790					
600	Tt-R 600 R	00>	0430		1330			1333		
600	Xj 600 Radian	84>91	0730		0730					
600	Xj 6F 600 Diversion	10>11	0410		2610		0413	2613		
600	Xj 6Fa 600 Diversion	11>	0410		2610		0413	2613		
600	Xj 6N 600	09>10	0410		2610		0413	2613		
600	Xj 6S 600 Diversion	09>11	0410		2610		0413	2613		
600	Xj S 600 Diversion	92>97	0400				0403			
600	Xj S 600 Diversion	98>02	0410				0413			
600	Xt E 600	90>02	3200		2730	1430	3203			
600	Xt K 600	91>93	3200		2730	1430	3203			
600	Yzf 600 R	>94			0730					
600	Yzf 600 R Thunder Cat	95>98	1060		0730		1063			
600	Yzf 600 R6	99>02	1060		2660		1063	2663		
600	Yzf 600 R6	03>11	1060		0930		1063	0933		
650	Xvs 650 A Drag Star Classic	98>05	0400				0403			
650	Xvs 650 Drag Star	97>02	0400				0403			
660	Mt-03 660	06>11	0410		1330		0413	1333		
660	Szr 660	96>	0520		0010		0523	0013		
660	Xt R 660	04>11	1010		1330		1013	1333		
660	Xt X 660	04>11	1100		1330		1103	1333		
660	Xt Z 660 Tenere	91>96	3200		2730	1430	3203			
660	Xt Z 660 Tenere	08>10	0430		1330			1333		
750	Fz 750	85>	0730		0730					
750	Fz 750 Genesis	87>	0730		0730					
750	Fzr 750 (O W01)	89>91	3030		0730		3033			
750	Fzr 750 Genesis	87>			0730		3123			

PASTIGLIE FRENO RMS - SINTER (RICERCA PER MARCA)

RMS - SINTER BRAKE PADS (SEARCH BY BRAND)

















CC	MODELLO MODEL	ANNO YEAR	RMS YOUR BEST PARTNER				SINTER	
			 ANTERIORE - FRONT		 POSTERIORE - REAR		 ANTERIORE FRONT	 POSTERIORE REAR
			PASTIGLIA ORGANICA - ORGANIC				PASTIGLIA SINTERIZZATA SINTERED	
								
			OMOLOGATA HOMOLOGATED	NON OMOLOGATA NOT HOMOLOGATED	GANASCE BRAKE SHOES	OMOLOGATA HOMOLOGATED	NON OMOLOGATA NOT HOMOLOGATED	GANASCE BRAKE SHOES
22 510		22 512	22 510		22512	22 510	22 510	
750	Fzx 750 Fazer	86>	0730		0730			
750	Tzr 750 W	89>	3030		0730		3033	
750	Xj 750 F	84>	0730		0730			
750	Xt Z 750 Super Tenere (Pinza Dx)	89>95	1420				1423	
750	Xt Z 750 Super Tenere (Pinza Sx)	89>95	1070				1073	
750	Xv 750	89>93	0730					
750	Xv 750 Virago	94>	0400				0403	
750	Yzf 750 R7 (Ow02) Road Version	99>	1060				1063	
750	Yzf 750 Rr-Sp	93>98			0730			
800	Fz8-N 800	11>	1060		0930		1063	0933
800	Fz8-Na 800	11>	1060		0930		1063	0933
800	Fz8-S 800	11>	1060		0930		1063	0933
800	Fz8-Sa 800	11>	1060		0930		1063	0933
850	Tdm 850	91>95			0730		3093	
850	Tdm 850	96>			0730			
850	Trx 850	95>	1100		0730		1103	
900	Tdm 900	02>05	1060		3130		1063	3133
900	Tdm 900 A	05>08	1060		3130		1063	3133
900	Xj 900	83>	0730		0730			
900	Xj 900	85>	0730		0730			
900	Xj 900 F	85>94	0730		0730			
900	Xj 900 Seca Diversion	95>	0400		0730		0403	
950	Xvs 950 A Midnight Star	09>11	0400		3130		0403	3133
1000	Fz1 1000	06>09	1060		0930		1063	0933
1000	Fz1 1000 Fazer	06>09	1060		0930		1063	0933
1000	Fz1 1000 Fazer Abs	07>08	1060		0930		1063	0933
1000	Fz1 1000 Fazer Abs	11>	1060		0930		1063	0933
1000	Fz1 1000 N - Na	11>	1060		0930		1063	0933
1000	Fzr 1000 Ex-Up	91>93			0730			
1000	Fzr 1000 Genesis - Ex-Up	86>88			0730		3093	
1000	Fzr 1000 R	94>			0730			
1000	Fzr 1000 R - Ex-Up	89>90			0730			
1000	Fzs 1000 Fazer	01>05	1060				1063	
1000	Gts 1000	93>			0730			
1000	Xv 1000 Virago	86>	0730					
1000	Yzf 1000 R Thunder Ace	96>	1060		0730		1063	
1000	Yzf 1000 R1	98>01	1060				1063	
1000	Yzf 1000 R1	02>03	1060		2660		1063	2663



PASTIGLIE FRENO RMS - SINTER (RICERCA PER MARCA)

RMS - SINTER BRAKE PADS (SEARCH BY BRAND)

CC	MODELLO MODEL	ANNO YEAR								
			 ANTERIORE - FRONT		 POSTERIORE - REAR		 ANTERIORE FRONT	 POSTERIORE REAR		
			PASTIGLIA ORGANICA - ORGANIC				PASTIGLIA SINTERIZZATA SINTERED			
			 OMOLOGATA HOMOLOGATED	 NON OMOLOGATA NOT HOMOLOGATED	 GANASCE BRAKE SHOES	 OMOLOGATA HOMOLOGATED	 NON OMOLOGATA NOT HOMOLOGATED	 GANASCE BRAKE SHOES		
			22 510		22 512	22 510		22512	22 510	22 510
1000	Yzf 1000 R1	04>06	1060		0930		1063	0933		
1000	Yzf 1000 R1	07>12			0930		2973	0933		
1100	Bt 1100 Bulldog	02>06	1060		0730		1063			
1100	Fj 1100 J	84>84	0730		0730					
1100	Xv 1100 Virago	86>93	0730							
1100	Xv 1100 Virago	94>98	0400				0403			
1100	Xv 1100 Virago	99>	0410		0730		0413			
1100	Xvs 1100 A Drag Star Classic	00>	0410		0730		0413			
1100	Xvs 1100 A V-Star Star Classic	01>	0410		0730		0413			
1100	Xvs 1100 Drag Star	99>	0410		0730		0413			
1200	1200 Venture	84>	0730		0730					
1200	1200 Venture Royale	87>	0730		0730					
1200	Fj 1200	86>87	0730		0730					
1200	Fj 1200	88>			0730		3123			
1200	Fj 1200 Abs	91>			0730		3123			
1200	Fj 1200 W - Wc	89>91			0730		3093			
1200	V-Max 1200 (Ymx 12N)	93>			0730					
1200	V-Max 1200 (Ymx 12N)	>92	0730		0730					
1200	Xjr 1200	94>			0730		3123			
1200	Xjr 1200	95>	1100		0730		1103			
1200	Xtz 1200 Super Tenere	10>11	1060		3130		1063	3133		
1200	Xvz 1200 12 T Td	85>	0730		0730					
1300	1300 Stryker	11>	0400		3130		0403	3133		
1300	Fjr 1300	01>04	1060		3130		1063	3133		
1300	Fjr 1300 A	03>05	1060		3130		1063	3133		
1300	Fjr 1300 A Abs	06>08	0380		3130		0383	3133		
1300	Fjr 1300 A Abs	11>	0380		3130		0383	3133		
1300	Fjr 1300 Abs	06>	0380		3130		0383	3133		
1300	Fjr 1300 As	06>08	0380		3130		0383	3133		
1300	Xjr 1300	99>01	1060		0730		1063			
1300	Xjr 1300	02>11	1060				1063			
1300	Xjr 1300 Sp	01>01	1060		0730		1063			
1300	Xv 1300 Ah/Ath Royal Star	96>					3123	3093		
1300	Xvs 1300 A Midnight Star	07>	0410		3130		0413	3133		
1300	Xvz 1300 Td	88>					3093	3093		
1300	Xvz 1300 Tf Royal Star Venture	99>	0400				0403	3093		
1600	Xv 1600 Road Star Silverado	99>02	0400				0403	3093		
1600	Xv 1600 Wild Star Silverado	99>02	0400				0403	3093		

PASTIGLIE FRENO RMS - SINTER (RICERCA PER MARCA)

RMS - SINTER BRAKE PADS (SEARCH BY BRAND)

















CC	MODELLO MODEL	ANNO YEAR	RMS YOUR BEST PARTNER				SINTER	
			ANTERIORE - FRONT		POSTERIORE - REAR		ANTERIORE FRONT	POSTERIORE REAR
			PASTIGLIA ORGANICA - ORGANIC				PASTIGLIA SINTERIZZATA SINTERED	
			OMOLOGATA HOMOLOGATED	NON OMOLOGATA NOT HOMOLOGATED	GANASCE BRAKE SHOES	OMOLOGATA HOMOLOGATED	NON OMOLOGATA NOT HOMOLOGATED	GANASCE BRAKE SHOES
22 510		22 512	22 510		22512	22 510	22 510	
1670	Xv 1670 Royals Star Warrior	02>	1060		3130		1063	3133
1700	Mt-01 1700	05>06	1060		2640	0890	1063	2643
1700	Mt-01 1700	07>			2640	0890	2973	2643
1700	Mt-01 1700	09>			2640	0890	2973	2643
1700	Mt-01S 1700	09>			2640	0890	2973	2643
1700	V Max 1700	09>10			3130		2973	3133
1700	Xv 1700 Pc Road Star Warrior	03>	1060		3130		1063	3133
1700	Xv 1700 Road Star Warrior	02>	1060				1063	3093
1700	Xv 1700 Warrior	03>04	1060		3130		1063	3133
1900	Xv 1900 A Midnight Star	07>09	1060		3130		1063	3133
1900	Xv 1900 Midnight Star	06>	1060		3130		1063	3133
YAMAHA ATV								
60	Ys 60 S (Moto4)	86>					0051	
60	Yt 60 L/N Tri Zinger	84>85					0051	
80	Yfm 80 Badger	92>01			0061			
80	Yfm 80 T/U	87>88			0051			
100	Yfm 100 T/U Champ	87>			0061			
100	Yfm 100 T/U Champ	87>88			0051			
100	Yfm 100 W/A/B Champ	89>91			0061			
125	Yfa 1 125 Breeze	89>91			0061			
125	Yfa 1 125 Breeze	92>02			0061			
175	Yt 175 J/K (Tri Moto)	82>83			0061			
200	Yfm 200 All Models (Moto 4)	85>89			0061			
200	Yfs 200 Blaster	88>01			0061			
200	Yfs 200 R Blaster	03>	1440		2850			2853
200	Ytm 200 All Models (Tri Moto)	83>85			0061			
225	Yfm 225 S/T/U (Moto 4)	86>88			0061			
225	Ytm 225 All Models (Tri Moto)	85>86			0061			
250	Yfb 250 D/E/F Timberwolf	92>94			0061			
250	Yfm 250 An Bruin 2X4	05>	1440					
250	Yfm 250 Bear Traker	01>	1440					
250	Ytz 250 N/S (Tri Moto)	85>86	2730	1430	2730	1430		
350	Yfm 350 Bruin 2X4 / 4X4	04>	1440					
350	Yfm 350 Ert/Eru	87>88			0061			
350	Yfm 350 F Wolverine	95>01	1440		2850			2853
350	Yfm 350 Fwb/Lc Big Bear	99>	1440					
350	Yfm 350 Fwt/Fwu Big Bear	87>88			2850			2853
350	Yfm 350 R Raptor	04>	2850		2850		2853	2853



PASTIGLIE FRENO RMS - SINTER (RICERCA PER MARCA)

RMS - SINTER BRAKE PADS (SEARCH BY BRAND)

CC	MODELLO MODEL	ANNO YEAR								
			 ANTERIORE - FRONT		 POSTERIORE - REAR		 ANTERIORE FRONT	 POSTERIORE REAR		
			PASTIGLIA ORGANICA - ORGANIC				PASTIGLIA SINTERIZZATA SINTERED			
			 OMOLOGATA HOMOLOGATED	 NON OMOLOGATA NOT HOMOLOGATED	 GANASCE BRAKE SHOES	 OMOLOGATA HOMOLOGATED	 NON OMOLOGATA NOT HOMOLOGATED	 GANASCE BRAKE SHOES		
			22 510	22 512	22 510	22512	22 510	22 510		
350	Yfm 350 X Warrior	90>01	1440		2850			2853		
350	Yfm 350 Xt	87>	2730	1430	2850			2853		
350	Yfm 350 Xu Warrior	88>	2730	1430	2850			2853		
350	Yfm 350 Xw Warrior	89>	1440		2850			2853		
350	Yfz 350 Banshee	90>01	1440		2850			2853		
350	Yfz 350 Banshee T/U/W	87>89	2730	1430	2850			2853		
400	Yfm 400 Big Bear 2Wd Nm/Nmc	00>	1440							
400	Yfm 400 F Big Bear	00>01	1440							
400	Yfm 400 F Big Bear 4Wd	01>	1440							
400	Yfm 400 Fam/Fan Kodiak	00>01	1440		2870			2873		
400	Yfm 400 Fwn Big Bear 4Wd	00>	1440		2870			2873		
400	Yfm 400 Kodiak 2Wd Am/An	00>01	1440		2870			2873		
400	Yfm 400 N Big Bear 2Wd	00>	1440		2870			2873		
450	Yfm 450 Far Kodiak	03>	1440		2870			2873		
450	Yzf 450 S (Pinza Dx)	04>	1420		2850		1423	2853		
450	Yzf 450 S (Pinza Sx)	04>	1070		2850		1073	2853		
600	Yfm 600 Grizzly	02>05	2850					2853		
600	Yfm 600 Grizzly 4X4	98>01	2850					2853		
600	Yfm 600 Grizzly Hunter Edition	01>	2850					2853		
600	Yfm 600 Grizzly Hunting	00>	2850					2853		
660	Rhino 660 (Pinza Dx)	05>	1070					1073		
660	Rhino 660 (Pinza Sx)	05>	1420					1423		
660	Yfm 660 Grizzly	02>	2850					2853		
660	Yfm 660 Raptor Rn	01>	2850		2850		2853	2853		
660	Yxr 660 Rhino 4X4 (Pinza Sx)	04>06			3180			3183		
660	Yxr 660 Rhino 4X4 (Pinza Dx)	04>06	1070				1073			
660	Yxr 660 Rhino 4X4 (Pinza Sx)	04>06	1420				1423			
700	Yfm 700 Raptor (Pinza Dx)	06>07	1070		3180		1073	3183		
700	Yfm 700 Raptor (Pinza Sx)	06>07	1420		3180		1423	3183		
ZANELLA										
50	Racing Moped 50	92>	0010					0013		
125	Rza 125	92>	0010					0013		
ZUNDAPP										
80	Ks 80 Super	80>	0010				0013			
80	Ks 80 Touring K	82>	0030							
80	Ks 80 Touring L	82>	0030							
125	Ks 125	82>	3150				3153			
175	Ks 175	82>	3150				3153			

▶ DISCHI FRENO

BRAKE DISCS



DISCHI FRENO BRAKE DISCS

APRILIA

22 516 0020

(R.O. AP8213383)

Ø esterno mm Ø External mm	Ø interno mm Ø Internal mm	Spessore mm Thickness mm	Ø Fori Fiss. mm Ø Fixing holes mm
155	40,7	3,6	10,7

22 516 0040

(R.O. AP8213381)

Ø esterno mm Ø External mm	Ø interno mm Ø Internal mm	Spessore mm Thickness mm	Ø Fori Fiss. mm Ø Fixing holes mm
220	60	4	6,5

22 516 0050

(R.O. AP8113541)

Ø esterno mm Ø External mm	Ø interno mm Ø Internal mm	Spessore mm Thickness mm	Ø Fori Fiss. mm Ø Fixing holes mm
220	60	4	8



MODELLO MODELS	CC	ANNO YEAR	ANT FRONT	POST. REAR
Amico	50	94	.	.
Sonic	50	98-07	.	.
Sonic Gp	50	98-08	.	.

22 516 0200

(R.O. AP8213231)

Ø esterno mm Ø External mm	Ø interno mm Ø Internal mm	Spessore mm Thickness mm	Ø Fori Fiss. mm Ø Fixing holes mm
190	58	4	8



MODELLO MODELS	CC	ANNO YEAR	ANT FRONT	POST. REAR
Area 51	50	98-00	.	.
Gulliver	50	95-98	.	.
Gulliver Lc	50	96-98	.	.
Mojito	50	04-08	.	.
Mojito Custom	50	99-03	.	.
Mojito Custom 2T Piaggio	50	04-10	.	.
Mojito Retro	50	99-03	.	.
Rally	50	95-03	.	.
Rally Liquid Cooled	50	96-99	.	.
Scarabeo	50	98	.	.
Scarabeo	50	99-05	.	.
Scarabeo Ditech	50	01-04	.	.
Sr	50	93-96	.	.
Sr Ditech Eu2	50	02-03	.	.
Sr H2O Ditech e Carburatore	50	00-03	.	.
Sr Liquid Cooled	50	94-96	.	.
Sr R Factory Motore Aprilia	50	05	.	.
Sr R R Factory	50	04-10	.	.
Sr Stealth, Racing	50	97-99	.	.
Sr Street	50	03-12	.	.
Sr Www	50	97-01	.	.
Sr ie e Carburatore	50	14	.	.
Sr R Factory ie e Carburatore	50	10-14	.	.
Leonardo	125	96-01	.	.
Leonardo St	125	01-04	.	.
Mojito	125	03-08	.	.
Mojito Retro' - Custom	125	99-01	.	.
Sr	125	99-01	.	.

22 516 0250

(R.O. AP8113697)

Ø esterno mm Ø External mm	Ø interno mm Ø Internal mm	Spessore mm Thickness mm	Ø Fori Fiss. mm Ø Fixing holes mm
260	60	4	8,5



MODELLO MODELS	CC	ANNO YEAR	ANT FRONT	POST. REAR
Scarabeo	125	03-06	.	.
Scarabeo Eu3	125	06-07	.	.
Scarabeo Motore Rotax	125	99-04	.	.
Scarabeo Motore Piaggio	125	06	.	.
Sport City	125	04-06	.	.
Sport City Eu3	125	06-08	.	.
Sport City Cube	125	08-10	.	.
Sport City Street	125	12	.	.
Scarabeo Light	250	06-08	.	.
Sport City	250	08-12	.	.
Scarabeo Light	300	09-10	.	.
Sport City Street	300	12	.	.
Scarabeo Light	400	06-08	.	.
Atlantic	500	01-04	.	.
Scarabeo	500	03-06	.	.

22 516 0260

(R.O. AP8113697)

Ø esterno mm Ø External mm	Ø interno mm Ø Internal mm	Spessore mm Thickness mm	Ø Fori Fiss. mm Ø Fixing holes mm
260	60	4	8,5



MODELLO MODELS	CC	ANNO YEAR	ANT FRONT	POST. REAR
Scarabeo Light	250	06-08	.	.
Sport City Cube	250	08-10	.	.
Scarabeo Light	250	06-08	.	.
Sport City	250	08-12	.	.
Scarabeo Light	300	09-10	.	.
Sport City Street	300	12	.	.
Scarabeo Light	400	06-08	.	.
Atlantic	500	01-04	.	.
Scarabeo	500	03-06	.	.
Scarabeo Light	300	09	.	.
Scarabeo Light	400	06-08	.	.
Atlantic	500	01-04	.	.
Scarabeo	500	03-06	.	.



APRILIA

22 516 2130

(R.O. AP8133601)			
Ø esterno mm Ø External mm	Ø interno mm Ø Internal mm	Spessore mm Thickness mm	Ø Fori Fiss. mm Ø Fixing holes mm
190	68	4,1	8,5



22 516 2140

(R.O. AP8133606)			
Ø esterno mm Ø External mm	Ø interno mm Ø Internal mm	Spessore mm Thickness mm	Ø Fori Fiss. mm Ø Fixing holes mm
240	105	4,5	6,6



22 516 2150

(R.O. AP8133627)			
Ø esterno mm Ø External mm	Ø interno mm Ø Internal mm	Spessore mm Thickness mm	Ø Fori Fiss. mm Ø Fixing holes mm
240	125	4,1	6,6



MODELLO MODELS	CC	ANNO YEAR	ANT FRONT	POST. REAR
Sr R Factory ie e Carburatore	50	10-14		•
Sr R R Factory	50	04-09		•
Atlantic	125	03-05		•
Atlantic Eu3	125	06-12		•
Atlantic	300	10-11		•

MODELLO MODELS	CC	ANNO YEAR	ANT FRONT	POST. REAR
Atlantic	125	03-05	•	
Atlantic Eu3	125	06-08	•	
Atlantic Eu3	125	10-11	•	
Atlantic	300	10-11	•	

MODELLO MODELS	CC	ANNO YEAR	ANT FRONT	POST. REAR
Scarabeo Mot. Piaggio Eu3	125	06		•
Scarabeo	125	03-06		•
Scarabeo Light	400	06-08		•
Scarabeo Light	500	06-08		•

22 516 2070

(R.O. 56393R)			
Ø esterno mm Ø External mm	Ø interno mm Ø Internal mm	Spessore mm Thickness mm	Ø Fori Fiss. mm Ø Fixing holes mm
260	125	5	6,5



MODELLO MODELS	CC	ANNO YEAR	ANT FRONT	POST. REAR
Sr Max	300	10		•

22 516 2160

(R.O. 852437)			
Ø esterno mm Ø External mm	Ø interno mm Ø Internal mm	Spessore mm Thickness mm	Ø Fori Fiss. mm Ø Fixing holes mm
240	125	4,1	6,6



MODELLO MODELS	CC	ANNO YEAR	ANT FRONT	POST. REAR
Scarabeo Light	250	06-08		•
Scarabeo Light	300	09-10		•

ATALA

22 516 0120

Ø esterno mm Ø External mm	Ø interno mm Ø Internal mm	Spessore mm Thickness mm	Ø Fori Fiss. mm Ø Fixing holes mm
155	39	4,1	6,5



MODELLO MODELS	CC	ANNO YEAR	ANT FRONT	POST. REAR
At 10	50	-		•



DISCHI FRENO

BRAKE DISCS

BENELLI

22 516 0010

(R.O. 810011A0)

Ø esterno mm Ø External mm	Ø interno mm Ø Internal mm	Spessore mm Thickness mm	Ø Fori Fiss. mm Ø Fixing holes mm
190	58	4	9



MODELLO MODELS	CC	ANNO YEAR	ANT FRONT	POST. REAR
491 Gt	50	98-99	•	
491 Racing	50	98-99	•	
491 Rr	50	98-01	•	
491 Rr Morini	50	03-04	•	
491 Sp	50	99	•	
491 Sport	50	98-99	•	
491 St	50	-	•	
491 St Morini	50	03	•	
K2	50	98-01	•	
K2	100	99-01	•	

BETA

22 516 0010

(R.O. 1333290000)

Ø esterno mm Ø External mm	Ø interno mm Ø Internal mm	Spessore mm Thickness mm	Ø Fori Fiss. mm Ø Fixing holes mm
190	58	4	9



MODELLO MODELS	CC	ANNO YEAR	ANT FRONT	POST. REAR
Ark Air	50	96-08	•	
Ark Lc	50	96-03	•	
Ark Lc Serie K	50	04-08	•	
Elkon	50	99-03	•	

22 516 0200

(R.O. 1339300000)

Ø esterno mm Ø External mm	Ø interno mm Ø Internal mm	Spessore mm Thickness mm	Ø Fori Fiss. mm Ø Fixing holes mm
190	58	4	8



MODELLO MODELS	CC	ANNO YEAR	ANT FRONT	POST. REAR
Ark Lc	50	96-03		•
Ark Lc Serie K	50	04-08		•
Elkon	50	99-03		•
Quadra Chrono 502	50	95-99	•	
Tempo	50	96-99	•	

DERBI

22 516 0140

(R.O. 564520)

Ø esterno mm Ø External mm	Ø interno mm Ø Internal mm	Spessore mm Thickness mm	Ø Fori Fiss. mm Ø Fixing holes mm
175	73	4	6,5



MODELLO MODELS	CC	ANNO YEAR	ANT FRONT	POST. REAR
Gp Open Eu2	50	06-09		•

22 516 2110

(R.O. 56391R)

Ø esterno mm Ø External mm	Ø interno mm Ø Internal mm	Spessore mm Thickness mm	Ø Fori Fiss. mm Ø Fixing holes mm
220	105	4,1	6,6



MODELLO MODELS	CC	ANNO YEAR	ANT FRONT	POST. REAR
Gp1 Open Eu2	50	06-09	•	
Sonar 2T	50	09		•
Gp1 Low Seat Eu3	125	07-08		•
Sonar 4T	125	09	•	
Sonar 4T	150	09	•	
Gp1 Low Seat Eu3	250	07-08		•



GILERA

22 516 0020

(R.O. 271594)

Ø esterno mm Ø External mm	Ø interno mm Ø Internal mm	Spessore mm Thickness mm	Ø Fori Fiss. mm Ø Fixing holes mm
155	40,7	3,6	10,7



22 516 0140

(R.O. 564520)

Ø esterno mm Ø External mm	Ø interno mm Ø Internal mm	Spessore mm Thickness mm	Ø Fori Fiss. mm Ø Fixing holes mm
175	73	4	6,5



22 516 0160

(R.O. 563246)

Ø esterno mm Ø External mm	Ø interno mm Ø Internal mm	Spessore mm Thickness mm	Ø Fori Fiss. mm Ø Fixing holes mm
200	96	4	6,5



MODELLO MODELS	CC	ANNO YEAR	ANT FRONT	POST. REAR
Easy Moving	50	95-96	.	.

MODELLO MODELS	CC	ANNO YEAR	ANT FRONT	POST. REAR
Runner	50	97-00	.	.
Runner Poggiali	50	02	.	.
Runner Purejet	50	02-11	.	.
Runner Sp	50	02-12	.	.
Runner Sp Special Edition	50	07	.	.
Stalker	50	97-04	.	.

MODELLO MODELS	CC	ANNO YEAR	ANT FRONT	POST. REAR
Dna	50	00-07	.	.
Dna Gp Experience	50	03-04	.	.
Ice	50	01-05	.	.
Runner Vx-Vxr	125	00-04	.	.
Runner Vx-Vxr	180	00-04	.	.
Runner Vx-Vxr	200	00-04	.	.

22 516 0180

(R.O. 561714)

Ø esterno mm Ø External mm	Ø interno mm Ø Internal mm	Spessore mm Thickness mm	Ø Fori Fiss. mm Ø Fixing holes mm
220	58	4	6,5



22 516 0190

(R.O. 564573)

Ø esterno mm Ø External mm	Ø interno mm Ø Internal mm	Spessore mm Thickness mm	Ø Fori Fiss. mm Ø Fixing holes mm
220	105	4	6,5



22 516 0200

(R.O. 56408R)

Ø esterno mm Ø External mm	Ø interno mm Ø Internal mm	Spessore mm Thickness mm	Ø Fori Fiss. mm Ø Fixing holes mm
190	58	4	8



MODELLO MODELS	CC	ANNO YEAR	ANT FRONT	POST. REAR
Runner	50	97-00	.	.
Runner Poggiali	50	02	.	.
Runner Purejet	50	02-04	.	.
Runner Sp	50	02-04	.	.
Runner Fx-Fxr	125	97-02	.	.
Runner Vx-Vxr	125	00-04	.	.

MODELLO MODELS	CC	ANNO YEAR	ANT FRONT	POST. REAR
Runner Purejet	50	05-11	.	.
Runner Sp	50	05-09	.	.
Runner 4T St	125	08-13	.	.
Runner Vx	125	05-06	.	.
Runner Vx Race	125	06	.	.
Runner Vx Sc	125	06-07	.	.
Runner Vxr	200	05-11	.	.

MODELLO MODELS	CC	ANNO YEAR	ANT FRONT	POST. REAR
Stalker	50	97-11	.	.
Stalker Special Edition	50	07-08	.	.
Storm	50	94-95	.	.
Typhoon Xr	50	00	.	.
Typhoon	50	94-97	.	.
Typhoon X-Xr	125	99-00	.	.
Typhoon	125	95-98	.	.



DISCHI FRENO

BRAKE DISCS

GILERA

22 516 0230

(R.O. 564371)

Ø esterno mm Ø External mm	Ø interno mm Ø Internal mm	Spessore mm Thickness mm	Ø Fori Fiss. mm Ø Fixing holes mm
240	125,5	4	6,5

22 516 2060

(R.O. 649163)

Ø esterno mm Ø External mm	Ø interno mm Ø Internal mm	Spessore mm Thickness mm	Ø Fori Fiss. mm Ø Fixing holes mm
240	125	5	6,5

22 516 2070

(R.O. 56393R)

Ø esterno mm Ø External mm	Ø interno mm Ø Internal mm	Spessore mm Thickness mm	Ø Fori Fiss. mm Ø Fixing holes mm
260	125	5	6,5



MODELLO MODELS	CC	ANNO YEAR	ANT FRONT	POST. REAR
Dna	50	00-07	•	
Dna Gp Experience	50	03-04	•	
Dna	125	01	•	•
Runner Fx-Fxr	125	97-02		•

MODELLO MODELS	CC	ANNO YEAR	ANT FRONT	POST. REAR
Nexus Eu3 le	125	08-10		•
Nexus Eu3	300	08		•
Fuoco	500	07-10		•
Nexus Eu3	500	09		•

MODELLO MODELS	CC	ANNO YEAR	ANT FRONT	POST. REAR
Nexus Eu3 ie	125	07-11	•	
Nexus Eu3	250	06		•
Nexus Eu3	300	08-11	•	
Nexus Eu3	500	06-11	•	

22 516 2110

(R.O. 56391R-56484R)

Ø esterno mm Ø External mm	Ø interno mm Ø Internal mm	Spessore mm Thickness mm	Ø Fori Fiss. mm Ø Fixing holes mm
220	105	4,1	6,6

22 516 2120

(R.O. 56391R-56484R)

Ø esterno mm Ø External mm	Ø interno mm Ø Internal mm	Spessore mm Thickness mm	Ø Fori Fiss. mm Ø Fixing holes mm
240	105	4,1	6,6



MODELLO MODELS	CC	ANNO YEAR	ANT FRONT	POST. REAR
Runner Purejet	50	08	•	
Runner Purejet St	50	07	•	
Runner Sp	50	05-07	•	
Runner Sp Special Edition	50	07	•	
Runner Sp St & Simoncelli	50	08-09	•	
Runner Purejet	50	10	•	
Runner Sp	50	10	•	
Runner Vx	125	05-06		•
Runner Vx 4T Eu3	125	06-07		•
Runner Vxr	200	05-06		•
Runner Vxr Eu3	200	07		•

MODELLO MODELS	CC	ANNO YEAR	ANT FRONT	POST. REAR
Runner Vx	125	05-06	•	
Runner Vx 4T Eu3	125	06-07	•	
Runner Vx 4T St Eu3	125	08-10	•	
Runner Vxr	200	05-06	•	
Runner Vxr Eu3	200	07	•	
Runner Vxr 4T St Eu3	200	08-10	•	
Fuoco Eu3	500	07-11	•	



HONDA

22 516 0070

(R.O. 45351-GBY-910ZA)

Ø esterno mm Ø External mm	Ø interno mm Ø Internal mm	Spessore mm Thickness mm	Ø Fori Fiss. mm Ø Fixing holes mm
220	88	4,1	10,3



22 516 0210

(R.O. 45121-GAV-700ZB)

Ø esterno mm Ø External mm	Ø interno mm Ø Internal mm	Spessore mm Thickness mm	Ø Fori Fiss. mm Ø Fixing holes mm
190	58	4	10,7



22 516 2200

(R.O. 45351-KGF-900)

Ø esterno mm Ø External mm	Ø interno mm Ø Internal mm	Spessore mm Thickness mm	Ø Fori Fiss. mm Ø Fixing holes mm
220	105	4	10,5



MODELLO MODELS	CC	ANNO YEAR	ANT FRONT	POST. REAR
Sh	50	96-01	•	
Sh Scoopy	50	96-01	•	
Sh	100	96-00	•	
Sh Scoopy	100	96-00	•	

MODELLO MODELS	CC	ANNO YEAR	ANT FRONT	POST. REAR
Sj Bali	50	93-99	•	
Sky	50	97	•	
Sj Bali	100	96-99	•	

MODELLO MODELS	CC	ANNO YEAR	ANT FRONT	POST. REAR
Chiocciola	125	00-08	•	
Dylan	125	01-06	•	
Sh 125	125	00-08	•	
Sh 125 (Tamburo - Rear Drum)	125	09	•	
Ps I	125	06	•	
Chiocciola	150	00-08	•	
Dylan	150	01-06	•	
Sh 150	150	01-08	•	
Sh 150 (Tamburo - Rear Drum)	150	09	•	
Ps I	150	06	•	

22 516 0350

(R.O. 45351-KRJ-901)

Ø esterno mm Ø External mm	Ø interno mm Ø Internal mm	Spessore mm Thickness mm	Ø Fori Fiss. mm Ø Fixing holes mm
240	105	4	10,5



22 516 0360

(R.O. 43251-MV4-00)

Ø esterno mm Ø External mm	Ø interno mm Ø Internal mm	Spessore mm Thickness mm	Ø Fori Fiss. mm Ø Fixing holes mm
220	105	5	10,6



22 516 2090

(R.O. 45351-KTW-901)

Ø esterno mm Ø External mm	Ø interno mm Ø Internal mm	Spessore mm Thickness mm	Ø Fori Fiss. mm Ø Fixing holes mm
256	144	4,5	10,5



MODELLO MODELS	CC	ANNO YEAR	ANT FRONT	POST. REAR
Silver Wing	125	07-12	•	
Pantheon	125	03-07	•	
Pantheon	150	03-07	•	
Foresight	250	99-07	•	

MODELLO MODELS	CC	ANNO YEAR	ANT FRONT	POST. REAR
Pantheon	125	03-07	•	
Silver Wing	125	08>	•	
Pantheon	150	03-07	•	
Silver Wing	150	07>	•	
Foresight	250	99-07	•	
Forza Nss	250	00-04	•	
Jazz	250	01-04	•	
Cbr Rr	600	07-14	•	
Nx Doninator	650	88-92	•	
Cbr Rr		06-15	•	

MODELLO MODELS	CC	ANNO YEAR	ANT FRONT	POST. REAR
Forza	125	15	•	
Forza	250	08-13	•	
Sh 300	300	06-14	•	
Forza	300	14-15	•	
Silver Wing	400	06-08	•	
Silver Wing	600	01-06	•	



DISCHI FRENO

BRAKE DISCS

HONDA

22 516 2100

(R.O. 43251-KTW-901)

Ø esterno mm Ø External mm	Ø interno mm Ø Internal mm	Spessore mm Thickness mm	Ø Fori Fiss. mm Ø Fixing holes mm
256	144	5	10,5

22 516 2260

(R.O. 43251-KTF-891)

Ø esterno mm Ø External mm	Ø interno mm Ø Internal mm	Spessore mm Thickness mm	Ø Fori Fiss. mm Ø Fixing holes mm
240	105	5	10,5



ITALJET

22 516 0020

Ø esterno mm Ø External mm	Ø interno mm Ø Internal mm	Spessore mm Thickness mm	Ø Fori Fiss. mm Ø Fixing holes mm
155	40,7	3,6	10,7



MODELLO MODELS	CC	ANNO YEAR	ANT FRONT	POST. REAR
Sh 300	300	07-15		•

MODELLO MODELS	CC	ANNO YEAR	ANT FRONT	POST. REAR
SH I		10-16		•

MODELLO MODELS	CC	ANNO YEAR	ANT FRONT	POST. REAR
Bazooka	50	-		•
Pista	50	-		•

KYMCO

22 516 2210

(R.O. 00145010)

Ø esterno mm Ø External mm	Ø interno mm Ø Internal mm	Spessore mm Thickness mm	Ø Fori Fiss. mm Ø Fixing holes mm
260	-	4,2	10,5

22 516 2220

(R.O. 00143057)

Ø esterno mm Ø External mm	Ø interno mm Ø Internal mm	Spessore mm Thickness mm	Ø Fori Fiss. mm Ø Fixing holes mm
240	-	4	10,5

22 516 2230

(R.O. 00143068)

Ø esterno mm Ø External mm	Ø interno mm Ø Internal mm	Spessore mm Thickness mm	Ø Fori Fiss. mm Ø Fixing holes mm
240	-	5	10,5



MODELLO MODELS	CC	ANNO YEAR	ANT FRONT	POST. REAR
Agility 2T R16	50	10-12		•
Agility 4T R16	50	08-12		•
People S 4T - S	50	05-08		•
Agility Plus 2T	50	14		•
Agility Plus 4T	50	14		•
Agility R16	125	08-12		•
Agility Plus	125	14-16		•
People S Dd Eu 3	125	07-08		•
People S	125	05		•
Agility R16	150	08-09		•
Agility R16	200	10-12		•
Agility Plus	200	14-16		•
People S I	200	07		•
People S	200	05		•
People S I	250	07	Ant./Sx	
People S	250	06	Ant./Sx	
People S I	300	08	Ant./Sx	

MODELLO MODELS	CC	ANNO YEAR	ANT FRONT	POST. REAR
Agility Plus	125	14-16		•
Agility R16	125	08-12		•
Agility R16	150	08-09		•
Agility R16	200	10-12		•
Agility Plus	200	14-16		•

MODELLO MODELS	CC	ANNO YEAR	ANT FRONT	POST. REAR
Downtown	125	09		•
Downtown I	200	10		•
Downtown I	300	09-11		•



KYMCO

22 516 2240 

(R.O. 00143088)

Ø esterno mm Ø External mm	Ø interno mm Ø Internal mm	Spessore mm Thickness mm	Ø Fori Fiss. mm Ø Fixing holes mm
240	88	5	10,5



MODELLO MODELS	CC	ANNO YEAR	ANT FRONT	POST. REAR
Downtown Abs I	300	11		•
Downtown Abs	300	10		•

22 516 2250 

(R.O. 00145128)

Ø esterno mm Ø External mm	Ø interno mm Ø Internal mm	Spessore mm Thickness mm	Ø Fori Fiss. mm Ø Fixing holes mm
200	58,2	4	10,5



MODELLO MODELS	CC	ANNO YEAR	ANT FRONT	POST. REAR
Agility 4T Carry	50	11		•
Agility Rs Naked 2T	50	10		•
Agility Rs	50	09		•
Agility Rs	125	09		•

22 516 2290 

(R.O. 00145090)

Ø esterno mm Ø External mm	Ø interno mm Ø Internal mm	Spessore mm Thickness mm	Ø Fori Fiss. mm Ø Fixing holes mm
260	58	4	10,5



MODELLO MODELS	CC	ANNO YEAR	ANT FRONT	POST. REAR
Downtown i	125	09-16		•
K-Xct i	125	12-14		•
Downtown i	200	10		•
Downtown i	300	09-11		•
K-Xct i	300	12		•
Downtown i	350	15-16		•

22 516 2300 

(R.O. 00145121)

Ø esterno mm Ø External mm	Ø interno mm Ø Internal mm	Spessore mm Thickness mm	Ø Fori Fiss. mm Ø Fixing holes mm
260	58	4	10,3



MODELLO MODELS	CC	ANNO YEAR	ANT FRONT	POST. REAR
Downtown Abs i	300	11		•
Downtown Abs	300	10		•
K-Xct i Abs	300	14		•

22 516 2310 

(R.O. 00143120)

Ø esterno mm Ø External mm	Ø interno mm Ø Internal mm	Spessore mm Thickness mm	Ø Fori Fiss. mm Ø Fixing holes mm
260	125	4,80	10,5



MODELLO MODELS	CC	ANNO YEAR	ANT FRONT	POST. REAR
People Gti	125	10-14		•
People Gti	200	10-14		•
People Gti Abs	300	12-14		•
People Gti	300	10-14		•

22 516 2320 

(R.O. 00156320)

Ø esterno mm Ø External mm	Ø interno mm Ø Internal mm	Spessore mm Thickness mm	Ø Fori Fiss. mm Ø Fixing holes mm
260	-	4,2	10,5



MODELLO MODELS	CC	ANNO YEAR	ANT FRONT	POST. REAR
People S Dd Eu3	125	07-08		•
People S I	200	07		•
People Lc	250	03-04		•
People S I	250	07	Ant. Dx	•
People S	250	06	Ant. Dx	•
People S I	300	08	Ant. Dx	•



DISCHI FRENO BRAKE DISCS

KYMCO

22 516 2360

(R.O. 00145000)

Ø esterno mm Ø External mm	Ø interno mm Ø Internal mm	Spessore mm Thickness mm	Ø Fori Fiss. mm Ø Fixing holes mm
240	128	4	10,5

22 516 2410

(R.O. 00145246)

Ø esterno mm Ø External mm	Ø interno mm Ø Internal mm	Spessore mm Thickness mm	Ø Fori Fiss. mm Ø Fixing holes mm
225	88	4	10,5



MODELLO MODELS	CC	ANNO YEAR	ANT FRONT	POST. REAR
Super 8 2T - 4T	50	09-13	•	
Super 8	50	07	•	
Super 8	125	08-09	•	

MODELLO MODELS	CC	ANNO YEAR	ANT FRONT	POST. REAR
People One I	125	13-16	•	

MALAGUTI

22 516 0010

(R.O.11943000)

Ø esterno mm Ø External mm	Ø interno mm Ø Internal mm	Spessore mm Thickness mm	Ø Fori Fiss. mm Ø Fixing holes mm
190	58	4	9

22 516 0120

(R.O. 11939800)

Ø esterno mm Ø External mm	Ø interno mm Ø Internal mm	Spessore mm Thickness mm	Ø Fori Fiss. mm Ø Fixing holes mm
155	39	4,1	6,5

22 516 0240

(R.O. 11946500)

Ø esterno mm Ø External mm	Ø interno mm Ø Internal mm	Spessore mm Thickness mm	Ø Fori Fiss. mm Ø Fixing holes mm
200	58	4	9,4



MODELLO MODELS	CC	ANNO YEAR	ANT FRONT	POST. REAR
Crosser Cr1	50	95-98	•	
F12 Lc Rst Eu2	50	08		•
F12 Phantom	50	94-98	•	
F12 Phantom Lc	50	94-98	•	
F12 Phantom Lc Eu1	50	99-00		•
F12 Phantom Lc Rst Eu1	50	01-02		•
F12 Phantom Lc Rst Eu2	50	02		•
F12 Phantom Lc Rst Eu2-2.3	50	03-04		•
F12 Phantom Lc Twin Disks	50	98	•	•
F15 Fire Fox	50	96-98	•	
F15 Fire Fox Eu2	50	02-03		•
F15 Fire Fox Rst Eu2-2.3	50	03-04		•
F15 Fire Fox Twin Disks & Special	50	98-99	•	•
F15 Fire Fox Twin Disks Digit Kat	50	98-00		•
F15 Lc Rst Eu2	50	04-05		•
F15 Lc-Tds Rst Eu1	50	01		•
F12 Phantom	100	99-00		•

MODELLO MODELS	CC	ANNO YEAR	ANT FRONT	POST. REAR
F10 Ac	50	08	•	
F10 Ac Eco	50	09-10		
F10 Jet Line	50	92-98	•	
F10 Kat	50	99-00	•	
F10 Rst Eu1	50	01-02	•	
F10 Rst Eu2	50	06	•	
F10 Rst Eu2	50	02-03	•	
F10 Rst Eu2-2.3	50	03-04	•	
Yesterday - Yesterday Eu	50	97-00	•	

MODELLO MODELS	CC	ANNO YEAR	ANT FRONT	POST. REAR
Ciak Elettrico	0	00-01	•	
F12 Aria Rst Eu2	50	06		•
F12 Lc Rst Eu2	50	08		•
F12 Phantom Eu1	50	99-00		•
F12 Phantom Lc Eu1	50	99-00		•
F12 Phantom Lc Rst Eu1	50	01-02		•
F12 Phantom Lc Rst Eu2	50	02		•
F12 Phantom Lc Rst Eu2-2.3	50	03-04		•
F12 Phantom Rst Eu1	50	01-02		•
F12 Phantom Rst Eu2	50	02		•
F12 Phantom Rst Eu2-2.3	50	03-04		•
F15 Fire Fox Air Cooled	50	05-06		•
F15 Fire Fox Eu2	50	02-03		•
F15 Fire Fox Rst Eu2-2.3	50	03-04		•
F15 Fire Fox Twin Disks Digit Kat	50	98-00		•
F15 Lc Rst Eu2	50	04-05		•
F15 Lc-Tds Rst Eu1	50	01		•
F12 Phantom	100	99-00		•



MBK

22 516 0020

(R.O. 2NA258310000)			
Ø esterno mm Ø External mm	Ø interno mm Ø Internal mm	Spessore mm Thickness mm	Ø Fori Fiss. mm Ø Fixing holes mm
155	40,7	3,6	10,7



22 516 0130

(R.O. 4VUF582T0000)			
Ø esterno mm Ø External mm	Ø interno mm Ø Internal mm	Spessore mm Thickness mm	Ø Fori Fiss. mm Ø Fixing holes mm
180	48	3,5	10



22 516 0200

(R.O. 5ADF58310000)			
Ø esterno mm Ø External mm	Ø interno mm Ø Internal mm	Spessore mm Thickness mm	Ø Fori Fiss. mm Ø Fixing holes mm
190	58	4	8



MODELLO MODELS	CC	ANNO YEAR	ANT FRONT	POST. REAR
Cw R Booster Road (Ita)	50	94-95	•	
Ye Evolis	50	92-95	•	
Ym Fizz [I]	50	94-95	•	
Ya R Forte (Che-Ita)	50	94-96	•	
Cr Z Target	50	91-95	•	

MODELLO MODELS	CC	ANNO YEAR	ANT FRONT	POST. REAR
Cw Booster	50	04	•	
Cw Booster	50	01-02	•	
Cw Booster Naked	50	03	•	
Cw Rs Booster Ng [I]	50	95-98	•	
Cw Rsp Booster Rocket [I]	50	97-98	•	
Cw Booster Spirit	50	99-00	•	
Cw Booster Spirit Eu2	50	02-03	•	
Cw Rxs Booster Track	50	96-98	•	

MODELLO MODELS	CC	ANNO YEAR	ANT FRONT	POST. REAR
Yn R Ovetto Eu1	50	02-04	•	
Yn R Ovetto Eu2	50	02-03	•	
Yn Ovetto	100	97-02	•	

22 516 0210

(R.O. 5JHF58310000)			
Ø esterno mm Ø External mm	Ø interno mm Ø Internal mm	Spessore mm Thickness mm	Ø Fori Fiss. mm Ø Fixing holes mm
190	58	4	10,7



22 516 2050

(R.O. 1B9F582W0100)			
Ø esterno mm Ø External mm	Ø interno mm Ø Internal mm	Spessore mm Thickness mm	Ø Fori Fiss. mm Ø Fixing holes mm
240	92	5	8,5



22 516 2330

(R.O. 4HC2582T0000)			
Ø esterno mm Ø External mm	Ø interno mm Ø Internal mm	Spessore mm Thickness mm	Ø Fori Fiss. mm Ø Fixing holes mm
245	115	4	8,5



MODELLO MODELS	CC	ANNO YEAR	ANT FRONT	POST. REAR
Cw Rs Booster Ng	50	99-03	•	
Yq Nitro	50	97-04	•	•
Ew Stunt	50	00-02	•	
Yq Nitro	100	00-02	•	

MODELLO MODELS	CC	ANNO YEAR	ANT FRONT	POST. REAR
Kilibre	300	03-06	•	

MODELLO MODELS	CC	ANNO YEAR	ANT FRONT	POST. REAR
Yp Skyliner	250	00-03	•	
Yp Skyliner Abs	250	03	•	



DISCHI FRENO
BRAKE DISCS

PEUGEOT

22 516 0010

(R.O. 746302)			
Ø esterno mm Ø External mm	Ø interno mm Ø Internal mm	Spessore mm Thickness mm	Ø Fori Fiss. mm Ø Fixing holes mm
190	58	4	9



22 516 0350

(R.O. 755162)			
Ø esterno mm Ø External mm	Ø interno mm Ø Internal mm	Spessore mm Thickness mm	Ø Fori Fiss. mm Ø Fixing holes mm
240	105	4	10,5



22 516 2180

(R.O. 1174630200)			
Ø esterno mm Ø External mm	Ø interno mm Ø Internal mm	Spessore mm Thickness mm	Ø Fori Fiss. mm Ø Fixing holes mm
190	58	3,5	12



MODELLO MODELS	CC	ANNO YEAR	ANT FRONT	POST. REAR
Buxy	50	94-97	•	
Elyseo	50	99	•	
Speedake	50	95-97	•	
Squab	50	95-97	•	
Sv Geo	50	91-95	•	
Vivacity	50	99	•	
Vivacity Catalitico	50	99-02	•	
Vivacity Vsx-Xr	50	02-04	•	
Looxor	100	01	•	
Sv L	100	98	•	
Trekker	100	98	•	
Vivacity	100	99-01	•	
Sv Geo	125	91-95	•	

MODELLO MODELS	CC	ANNO YEAR	ANT FRONT	POST. REAR
Sv	250	01-02	•	

MODELLO MODELS	CC	ANNO YEAR	ANT FRONT	POST. REAR
Jet Force	50	03		•
Vivacity	50	-		•
Jet Tech	50	10		•
Ludix Elegance 14"	50	10	•	
Looxor	100	-		•

PEUGEOT

22 516 2190

(R.O. 1176642400)			
Ø esterno mm Ø External mm	Ø interno mm Ø Internal mm	Spessore mm Thickness mm	Ø Fori Fiss. mm Ø Fixing holes mm
226	70	3,5	8,3



MODELLO MODELS	CC	ANNO YEAR	ANT FRONT	POST. REAR
Trk2 Wrc	50	04-06	•	
Jet Tech	50	10	•	

PGO

22 516 0020

(R.O. 2NA258310000)			
Ø esterno mm Ø External mm	Ø interno mm Ø Internal mm	Spessore mm Thickness mm	Ø Fori Fiss. mm Ø Fixing holes mm
155	40,7	3,6	10,7



MODELLO MODELS	CC	ANNO YEAR	ANT FRONT	POST. REAR
Big Max	50	-	•	



PIAGGIO

22 516 0020

(R.O. 271594)

Ø esterno mm Ø External mm	Ø interno mm Ø Internal mm	Spessore mm Thickness mm	Ø Fori Fiss. mm Ø Fixing holes mm
155	40,7	3,6	10,7



MODELLO MODELS	CC	ANNO YEAR	ANT FRONT	POST. REAR
Zip	50	95-96	•	
Zip Fast Raider	50	93-94	•	
Zip Fast Raider Rst	50	96-97	•	

22 516 0180

(R.O. 561714)

Ø esterno mm Ø External mm	Ø interno mm Ø Internal mm	Spessore mm Thickness mm	Ø Fori Fiss. mm Ø Fixing holes mm
220	58	4	6,5



MODELLO MODELS	CC	ANNO YEAR	ANT FRONT	POST. REAR
Nrg Extreme	50	99-00	•	
Nrg Mc3	50	01-04	•	
Nrg Purejet	50	02-04	•	
Skipper 4T	125	00-02	•	
Skipper Lx	125	98-99	•	

22 516 0140

(R.O. 564520)

Ø esterno mm Ø External mm	Ø interno mm Ø Internal mm	Spessore mm Thickness mm	Ø Fori Fiss. mm Ø Fixing holes mm
175	73	4	6,5



MODELLO MODELS	CC	ANNO YEAR	ANT FRONT	POST. REAR
Nrg Extreme	50	99-00	•	
Nrg Mc3	50	01-04	•	
Nrg Power Dd	50	05-15	•	
Nrg Power Dd Serie Speciale	50	07-12	•	
Nrg Power Purejet	50	04-11	•	
Nrg Purejet	50	02-04	•	
Nrg Rst Mc2	50	96-98	•	
Zip	50	00-04	•	
Zip 4T	50	00-13	•	
Zip 4T	100	06-10	•	
Zip	125	00-02	•	

22 516 0160

(R.O. 563246)

Ø esterno mm Ø External mm	Ø interno mm Ø Internal mm	Spessore mm Thickness mm	Ø Fori Fiss. mm Ø Fixing holes mm
200	96	4	6,5



MODELLO MODELS	CC	ANNO YEAR	ANT FRONT	POST. REAR
Fly 2T	50	05-07	•	
Fly 2T	50	10-11	•	
Fly 4T Motore Chn	50	06-07	•	
Sfera Rst	50	95-97	•	
Free Delivery	50	00-01	•	
Free FL	50	95-02	•	
Vespa Et2 Iniezione	50	97-00	•	
Vespa Et2	50	97-05	•	
Vespa Et4	50	00-05	•	
Vespa Lx 4T	50	05-13		•
Vespa Lx 2T	50	05-13		•
Vespa Lxv 2T	50	06-08		•
Vespa Primavera 2T	50	13-15	•	
Vespa Primavera 4T 4V	50	13-16	•	
Vespa S 2T	50	08-12	•	
Vespa S 4T 4V	50	08-12	•	
Vespa Sprint 2T	50	14-16	•	
Vespa Sprint 4T 4V	50	14-16	•	
Zip Sp	50	96-13	•	
Fly 4T	100	06-08	•	
Fly	100	05-11	•	
Hexagon Gtx	125	00	•	
Hexagon Lx4	125	98-99	•	
Hexagon Lx-Lxt	125	98-99	•	•
Sfera	125	95-97	•	
Vespa Et4	125	96-02	•	
Vespa Lx	125	05-06	•	
Vespa Lx Eu3	125	06-08	•	
Vespa Lxv 4T Eu3	125	06-10	•	
Vespa Px Eu2	125	01-07	•	
Zip	125	00-02	•	
Vespa Lx	125	06-13	•	
Vespa Lx Primavera 4T 3V	125	13-16	•	
Vespa Lxv	125	10-13	•	
Vespa Px	125	98-16	•	
Vespa S 4T	125	07-15	•	
Vespa Sprint 4T 3V	125	14-15	•	
Vespa Lx	150	05-13	•	
Vespa Lx Eu3	150	06-08	•	
Fly	150	05-11	•	
Vespa Primavera 4T 3V	150	13-16	•	
Vespa Px	150	11-16	•	
Vespa S 4T	150	08-12	•	
Hexagon Gt-Gtx	250	98-00	•	•



DISCHI FRENO

BRAKE DISCS

PIAGGIO

22 516 0190



(R.O. 564573)

Ø esterno mm Ø External mm	Ø interno mm Ø Internal mm	Spessore mm Thickness mm	Ø Fori Fiss. mm Ø Fixing holes mm
220	105	4	6,5



22 516 0200



(R.O. 56408R)

Ø esterno mm Ø External mm	Ø interno mm Ø Internal mm	Spessore mm Thickness mm	Ø Fori Fiss. mm Ø Fixing holes mm
190	58	4	8



22 516 0230



(R.O. 564371)

Ø esterno mm Ø External mm	Ø interno mm Ø Internal mm	Spessore mm Thickness mm	Ø Fori Fiss. mm Ø Fixing holes mm
240	125,5	4	6,5



MODELLO MODELS	CC	ANNO YEAR	ANT FRONT	POST. REAR
Liberty	50	97-05	•	
Liberty 2T	50	06-08	•	
Liberty 2T-4T Rst	50	04	•	
Liberty 2T-4T Sport	50	06-08	•	
Liberty 4T	50	00-08	•	
Liberty Ptt Eu2	50	04-15	•	
Nrg Power Dd	50	05-12	•	
Nrg Power Dt	50	06-15	•	
Nrg Power Purejet	50	04-11	•	
Nrg Purejet	50	10	•	
Free	100	02-03	•	
Fly 4T 3V	125	12-13	•	
Liberty	125	98-02	•	
Liberty 4T	125	06-15	•	
Liberty Rst	125	04-05	•	
Liberty Rst Ptt	125	05-11	•	
Liberty Sport	125	06	•	
Super Hexagon Gtx 12	125	01-02		•
Vespa Granturismo	125	03-07	•	•
Vespa Gts	125	07-16	•	
Vespa Gtv	125	06-08	•	•
Liberty 4T Eu3	150	08	•	
Liberty 4T Sport Eu3	150	08	•	
Liberty - Liberty Sport	200	06	•	
Liberty Rst	200	04	•	
Liberty	200	06	•	
Liberty 4T Sport Eu3	200	06-07	•	
Vespa Granturismo	200	06-07	•	
Vespa Gt 60	250	06-07		•
Vespa Gts	250	05-16	•	
Vespa Gtv	250	06-09	•	
Vespa Gts	300	10-16	•	
Vespa Gtv	300	10-13	•	

22 516 2060



(R.O. 649163)

Ø esterno mm Ø External mm	Ø interno mm Ø Internal mm	Spessore mm Thickness mm	Ø Fori Fiss. mm Ø Fixing holes mm
240	125	5	6,5



MODELLO MODELS	CC	ANNO YEAR	ANT FRONT	POST. REAR
Mp3 ie	125	08-12		•
Mp3 Yourban	125	11-13		•
Super Hexagon Gtx	125	01-02		•
X Evo	125	07		•
X7 Eu3	125	08		•
X7 Evo le Eu3	125	09		•
X8	125	05-06		•
X8 Premium Eu2	125	06		•
X8 Premium Eu3	125	06-07		•
Super Hexagon Gtx	180	01-04		•
X8	200	04-05		•
Mp3	250	06-08		•
Mp3 Lt	250	09		•
Mp3 Mic	250	08-10		•
X Evo	250	07		•
X7 Eu3	250	08		•
X8 Eu3	250	05-08		•
X7 Evo ie Eu3	300	09		•
Mp3	300	10-14		•
Mp3 Yourban ERL	300	11-15		•
Beverly Eu3	400	06-08		•
Beverly Tourer Eu3	400	08-10		•
Mp3 - Mp3 Lt	400	07-08		•
Mp3 Mic	400	08-10		•
X Evo	400	07-10		•
X8 Eu3	400	06-08		•
Beverly	500	02-06		•
Beverly Cruiser	500	07-12		•
Beverly Eu3	500	06-08		•
X9 Evolution	500	06-07		•

22 516 2070



(R.O. 56393R)

Ø esterno mm Ø External mm	Ø interno mm Ø Internal mm	Spessore mm Thickness mm	Ø Fori Fiss. mm Ø Fixing holes mm
260	125	5	6,5



MODELLO MODELS	CC	ANNO YEAR	ANT FRONT	POST. REAR
X Evo	125	07		•
X7 Eu3	125	08		•
X7 Evo le Eu3	125	09		•
X8	125	05-06		•
X8 Premium Eu2	125	06		•
X8 Premium Eu3	125	06-07		•
X8 Street Eu2	125	06-07		•
X8	200	05-07		•
X Evo	250	07		•
X7 Eu3	250	08		•
X8 Eu3	250	05-08		•
Carnaby Cruiser	300	09		•
X7 Evo le Eu3	300	09		•
Beverly Eu3	400	06-07		•
Beverly Tourer Eu3	400	08-10		•
Beverly Cruiser	500	07-11		•
X9 Evolution	500	06-07		•



PIAGGIO

22 516 2080



(R.O. 56397R)

Ø esterno mm Ø External mm	Ø interno mm Ø Internal mm	Spessore mm Thickness mm	Ø Fori Fiss. mm Ø Fixing holes mm
260	125	4	6,5



22 516 2110



(R.O. 56391R-56484R)

Ø esterno mm Ø External mm	Ø interno mm Ø Internal mm	Spessore mm Thickness mm	Ø Fori Fiss. mm Ø Fixing holes mm
220	105	4,1	6,6



22 516 2120



(R.O. 56394R-649226)

Ø esterno mm Ø External mm	Ø interno mm Ø Internal mm	Spessore mm Thickness mm	Ø Fori Fiss. mm Ø Fixing holes mm
240	105	4,1	6,6



MODELLO MODELS	CC	ANNO YEAR	ANT FRONT	POST. REAR
Beverly Tourer Eu3	125	08-10	.	
Carnaby	125	07-10	.	
Carnaby	200	07-08	.	
Beverly	250	06-07	.	
Beverly Cruiser	250	07-10	.	
Beverly le Eu3	250	06-08	.	
Beverly Tourer Eu3	250	08-10	.	
Carnaby	250	08	.	
Beverly 300 le Tourer	300	09	.	
Carnaby Cruiser	300	09	.	.

MODELLO MODELS	CC	ANNO YEAR	ANT FRONT	POST. REAR
Liberty 2T/4T/Sport	50	07-08	.	
Liberty 4T	50	05-08	.	
Liberty 4T Delivery Tnt	50	09	.	
Nrg Power Dd Serie Speciale	50	07-10	.	
Nrg Power Dt	50	07-08	.	
Nrg Power Dt Serie Speciale	50	07-08	.	
Nrg Power Purejet	50	10-11	.	
Nrg Purejet	50	10	.	
Liberty Sport	125	06	.	
Liberty 4T Eu3	125	07-08	.	
Liberty 4T Eu3 Delivery	125	08	.	
Liberty 4T Sport Eu3	125	06-08	.	
Vespa Granturismo Eu3	125	06-07	.	
Vespa Gts Eu3	125	07-10	.	.
Vespa Gts 4T le Super	125	09-11	.	.
Vespa Gtv 4T Navy Eu3	125	08	.	.
Liberty 4T Eu3	150	08	.	.
Liberty 4T Sport Eu3	150	08	.	.
Liberty 4T Eu3	200	07-08	.	
Liberty 4T Sport Eu3	200	06-07	.	
Vespa Gt 60 Eu3	250	06-07	.	
Vespa Gts, Gts Abs	250	05-10	.	.
Vespa Gtv	250	06-09	.	.
Vespa Gtv 4T Navy Eu3	250	08	.	.
Vespa Gts Super	300	08-10	.	.
Vespa Gts Super Sport	300	10	.	.
Vespa Gtv Via Monten.	300	10	.	.
Vespa Gtv 4T 4V le	300	10-11	.	.

MODELLO MODELS	CC	ANNO YEAR	ANT FRONT	POST. REAR
Mp3 Ibrido	125	09-10	.	
Mp3 le	125	08-09	.	
Mp3 Yourban Erl	125	11-13	.	
Mp3 Lt	250	09	.	
Mp3 Mic	250	08-09	.	
Mp3 Yourban Erl	300	11-15	.	
Mp3 300 le Lt	300	10-11	.	
Mp3 300 le Mic	300	10-11	.	
Mp3 4T 4V le Lt Ibrido	300	10-13	.	
Mp3 Mic	400	08-11	.	
Mp3 le Lt- Mp3 le Lt Sport	400	08-10	.	
Mp3 Lt Sport	500	11-13	.	
Mp3 RL Sport	500	11-12	.	

22 516 2170



(R.O. 56478R)

Ø esterno mm Ø External mm	Ø interno mm Ø Internal mm	Spessore mm Thickness mm	Ø Fori Fiss. mm Ø Fixing holes mm
240	125	4,4	6,6



MODELLO MODELS	CC	ANNO YEAR	ANT FRONT	POST. REAR
Liberty Moc 2T & Elle	50	09-13	.	
Liberty Moc 4T & Elle	50	09-16	.	
Liberty Moc 4T & Elle	125	09-10	.	
Liberty 4T 2V le Eu 3	125	09-13	.	
Liberty 4T 2V le Ptt-Ita	125	12-13	.	
Liberty 4T 3V le Eu 3	125	12-14	.	
Liberty Moc 4T Eu 3	150	09-13	.	

22 516 2400



(R.O. 666761)

Ø esterno mm Ø External mm	Ø interno mm Ø Internal mm	Spessore mm Thickness mm	Ø Fori Fiss. mm Ø Fixing holes mm
220	95	4	6



MODELLO MODELS	CC	ANNO YEAR	ANT FRONT	POST. REAR
Fly 4T 2V	50	12-15	.	
Fly 4T 4V	50	12-13	.	
Typhoon 2T	50	10-12	.	
Fly 4T 3V le Eu3	125	12-15	.	
Typhoon 4T 2V	125	10-11	.	

22 516 0370



(R.O. 59221-14G00-000)

Ø esterno mm Ø External mm	Ø interno mm Ø Internal mm	Spessore mm Thickness mm	Ø Fori Fiss. mm Ø Fixing holes mm
260	121	4,5	10,3



MODELLO MODELS	CC	ANNO YEAR	ANT FRONT	POST. REAR
An Burgman	250	03-06	.	
An Burgman	400	03-15	.	
An Burgman	650	04-11	.	

SUZUKI



DISCHI FRENO

BRAKE DISCS

YAMAHA

22 516 0020

(R.O. 2NA258310000)

Ø esterno mm Ø External mm	Ø interno mm Ø Internal mm	Spessore mm Thickness mm	Ø Fori Fiss. mm Ø Fixing holes mm
155	40,7	3,6	10,7



MODELLO MODELS	CC	ANNO YEAR	ANT FRONT	POST. REAR
Ya R Axis	50	95-96	•	
Ym Breeze	50	94-95	•	
Cr Z	50	91-95	•	

22 516 0130

(R.O. 4VUF582T0000)

Ø esterno mm Ø External mm	Ø interno mm Ø Internal mm	Spessore mm Thickness mm	Ø Fori Fiss. mm Ø Fixing holes mm
180	48	3,5	10



MODELLO MODELS	CC	ANNO YEAR	ANT FRONT	POST. REAR
Bw'S	50	04-16	•	
Bw'S Bump	50	97-98	•	
Bw'S Naked	50	03-16	•	
Bw'S Next Generation	50	97-98	•	
Bw'S Original	50	99-03	•	
Bw'S R	50	01	•	
Cw L Bw's	50	03-04	•	

22 516 0200

(R.O. 5ADF58310000)

Ø esterno mm Ø External mm	Ø interno mm Ø Internal mm	Spessore mm Thickness mm	Ø Fori Fiss. mm Ø Fixing holes mm
190	58	4	8



MODELLO MODELS	CC	ANNO YEAR	ANT FRONT	POST. REAR
Yn Neo'S	50	97-06	•	
Yn Neo'S Eu2	50	02-03	•	
Yn Neo'S	100	99-02	•	

22 516 0210

(R.O. 5JHF58310000)

Ø esterno mm Ø External mm	Ø interno mm Ø Internal mm	Spessore mm Thickness mm	Ø Fori Fiss. mm Ø Fixing holes mm
190	58	4	10,7



MODELLO MODELS	CC	ANNO YEAR	ANT FRONT	POST. REAR
Yq Aerox	50	01-02	•	•
Yq Aerox	50	04-08	•	•
Yq Aerox	50	97-98	•	•
Yq L Aerox Eu2	50	03	•	•
Yq Aerox R	50	99	•	•
Bw'S Next Generation	50	99-06	•	
Bw'S Next Generation Cat.	50	99-00	•	
Ew Slider	50	00-02	•	
Yq Aerox	100	00-02	•	

22 516 0300

(R.O. 5GM2582W0000)

Ø esterno mm Ø External mm	Ø interno mm Ø Internal mm	Spessore mm Thickness mm	Ø Fori Fiss. mm Ø Fixing holes mm
230	116	5	8,6



MODELLO MODELS	CC	ANNO YEAR	ANT FRONT	POST. REAR
Yp Majesty	250	00-03		•
Yp Majesty Abs	250	03		•

22 516 0310

(R.O. 5GJ2582T0000)

Ø esterno mm Ø External mm	Ø interno mm Ø Internal mm	Spessore mm Thickness mm	Ø Fori Fiss. mm Ø Fixing holes mm
282	132	5	8,6



MODELLO MODELS	CC	ANNO YEAR	ANT FRONT	POST. REAR
Xpt-Max	500	01-03	•	



YAMAHA

22 516 0320 

(R.O. 5VU2582W0000)			
Ø esterno mm Ø External mm	Ø interno mm Ø Internal mm	Spessore mm Thickness mm	Ø Fori Fiss. mm Ø Fixing holes mm
267	132	5	8,5



22 516 0390 

(R.O. 5CG2582W0000)			
Ø esterno mm Ø External mm	Ø interno mm Ø Internal mm	Spessore mm Thickness mm	Ø Fori Fiss. mm Ø Fixing holes mm
230	84	5	8,5



22 516 2040 

(R.O. 1B9F582U0000)			
Ø esterno mm Ø External mm	Ø interno mm Ø Internal mm	Spessore mm Thickness mm	Ø Fori Fiss. mm Ø Fixing holes mm
267	132	5	8,5



MODELLO MODELS	CC	ANNO YEAR	ANT FRONT	POST. REAR
Xp T-Max Abs	500	05-07		•
Xp T-Max Black - Night	500	07		•
Xp T-Max Black Max	500	06		•
Xp T-Max	500	01-07		•
Xj S Diversion	900	95-01		•
Fzs fazer		01-05		•
Bt Bulldog		05-97		•
Xjr		95-97		•
Xjr - Xjr P		99-01		•
Xjr		02-13		•
Xjr C		15		•

MODELLO MODELS	CC	ANNO YEAR	ANT FRONT	POST. REAR
Yp Majesty Dx	250	98-99		•

MODELLO MODELS	CC	ANNO YEAR	ANT FRONT	POST. REAR
Yp R X-Max Abs	125	11		•
Yp R X-Max	125	06-14		•
Yp Ra X-Max Abs	125	13-14		•
Yp Ra Black X-Max	250	09		•
Yp R X-Max Sport	250	11-12		•
Yp R X-Max	250	05-14		•
Yp Ra X-Max Abs	250	11-14		•
Yp X-Max	400	13-16		•
Yp Majesty	400	12-13		•

22 516 2050 

(R.O. 1B9F582W0100)			
Ø esterno mm Ø External mm	Ø interno mm Ø Internal mm	Spessore mm Thickness mm	Ø Fori Fiss. mm Ø Fixing holes mm
240	92	5	8,5



22 516 2270 

(R.O. 4B52582V0000)			
Ø esterno mm Ø External mm	Ø interno mm Ø Internal mm	Spessore mm Thickness mm	Ø Fori Fiss. mm Ø Fixing holes mm
267	132,25	5,10	8,5



22 516 2280 

(R.O. 5C2F58310000)			
Ø esterno mm Ø External mm	Ø interno mm Ø Internal mm	Spessore mm Thickness mm	Ø Fori Fiss. mm Ø Fixing holes mm
190	-	3,55	8,5



MODELLO MODELS	CC	ANNO YEAR	ANT FRONT	POST. REAR
Yp R X-Max	125	06-13		•
Vp X-City	125	08-11		•
Yp R X-Max	250	05-13		•
Vp X-City	250	07-14		•
Xc Versity	300	03-06		•

MODELLO MODELS	CC	ANNO YEAR	ANT FRONT	POST. REAR
Xp T-Max Abs Sv	500	11		•
Xp T-Max Abs	500	08-11		•
Xp T-Max Sv	500	11		•
Xp T-Max White Max	500	10		•
Xp T-Max	500	08		•
Xp T-Max	500	09-11		•

MODELLO MODELS	CC	ANNO YEAR	ANT FRONT	POST. REAR
Cs Jog R	50	06-15		•
Yn F Neo's 4	50	09-15		•
Yn Neo's	50	07-16		•



DISCHI FRENO
BRAKE DISCS

YAMAHA

22 516 2330

(R.O. 4HC2582T0000)			
Ø esterno mm Ø External mm	Ø interno mm Ø Internal mm	Spessore mm Thickness mm	Ø Fori Fiss. mm Ø Fixing holes mm
245	115	4	8,5



22 516 2340

(R.O. 5VU2581T0100-1SDF81T0000)			
Ø esterno mm Ø External mm	Ø interno mm Ø Internal mm	Spessore mm Thickness mm	Ø Fori Fiss. mm Ø Fixing holes mm
267	132	4	8,5



22 516 2350

(R.O. 4B52581T0000)			
Ø esterno mm Ø External mm	Ø interno mm Ø Internal mm	Spessore mm Thickness mm	Ø Fori Fiss. mm Ø Fixing holes mm
267	132	4	8,5



MODELLO MODELS	CC	ANNO YEAR	ANT FRONT	POST. REAR
Yp Majesty	250	00-03	•	
Yp Majesty	250	96-98	•	
Yp Majesty Abs	250	03	•	
Yp Majesty Dx	250	98-99	•	

MODELLO MODELS	CC	ANNO YEAR	ANT FRONT	POST. REAR
Yp X-Max	400	13-16	•	
Yp Ra X-Max Abs	400	14-16	•	
Xp T-Max Abs	500	06-07	•	
Xp T-Max Black Max-Night Max	500	06-07	•	
Xp T-Max	500	04-07	•	

MODELLO MODELS	CC	ANNO YEAR	ANT FRONT	POST. REAR
Xp T-Max	500	08-11	•	
Xp T-Max Abs	500	08-11	•	
Xp T-Max Sv	500	08-11	•	
Xp T-Max Abs	500	08-11	•	

22 516 2370

(R.O. 5EUF58310000)			
Ø esterno mm Ø External mm	Ø interno mm Ø Internal mm	Spessore mm Thickness mm	Ø Fori Fiss. mm Ø Fixing holes mm
220	88	4	8,4



22 516 2380

(R.O. 1B72582W0000)			
Ø esterno mm Ø External mm	Ø interno mm Ø Internal mm	Spessore mm Thickness mm	Ø Fori Fiss. mm Ø Fixing holes mm
245	115	5	8,4



22 516 2390

(R.O. 5B2F582T0000)			
Ø esterno mm Ø External mm	Ø interno mm Ø Internal mm	Spessore mm Thickness mm	Ø Fori Fiss. mm Ø Fixing holes mm
270	128	5	8,4



MODELLO MODELS	CC	ANNO YEAR	ANT FRONT	POST. REAR
Yh Why Eu1	50	99-00	•	
Yh Why Eu1	50	03-05	•	
Yh Why	50	98-06	•	

MODELLO MODELS	CC	ANNO YEAR	ANT FRONT	POST. REAR
Yp R X-Max Abs	125	11-16	•	
Yp Ra X-Max Abs	250	11-16	•	

MODELLO MODELS	CC	ANNO YEAR	ANT FRONT	POST. REAR
Yp X-City	125	08-11	•	
Yp X-City	250	07-15	•	

22 516 2430

(R.O. 1SDF582W0000)			
Ø esterno mm Ø External mm	Ø interno mm Ø Internal mm	Spessore mm Thickness mm	Ø Fori Fiss. mm Ø Fixing holes mm
266	132	5	8,2



MODELLO MODELS	CC	ANNO YEAR	ANT FRONT	POST. REAR
Yp R X-Max Momodesign	400	14	•	
Yp R X-Max	400	13-15	•	
Yp Ra X-Max Abs	400	14-16	•	
Yp Ra X-Max Momodesign Abs	400	14-15	•	



22 514 0060 

Ape 50 1 Serie
 (R.O. 117446)



22 514 0070 

Ape 50 • P 50 • Tm P50 • 50 Fl 2 • A 89-95 •
 50fl 3 Europa 96-98 • Rst Mix 50 A 99
 (R.O. 1745292)



22 514 0150 

Ape 50 • Fl • Fl 2 A 89-95 • Fl 3 Europa A.96-
 99 • Rst Mix A 99-05
 (R.O. 2457652)



22 514 0080 

Ape 175 Mp
 (R.O. 076031)



22 514 0090 

Ape 175 Mp
 (R.O. 076032)



22 514 0100 

Mp 600 • P 601 A 78-96
 (R.O. 137891)



22 514 0110 

Mp 600 • P 601 A 78-96
 (R.O. 137894)



22 514 0120 

Ape Car P 3 • Ape Tm P 703 • P 703 A 84-99
 Tm P 703 • P 703-V.Diesel Car • Max Diesel 86-
 96 • Ape Tm P 703 A 84 • Car Diesel A.86-96
 (R.O. 245194)



22 514 0130 

Ape Car P 3
 (R.O. 245193)



22 514 0140 

Ape Poker • Benzina-Diesel A.93
 (R.O. 227549)



22 514 0160 

Cosa 1-2
 (R.O. 248846)



22 514 0170 

Cosa 1-2
 (R.O. 228828)



SERIE GUARNIZIONI CILINDRETTI FRENI - BRAKE CYLINDER GASKET SETS

22 514 0010 

Anteriore - Front Ape Mp-Car (4 Pezzi - 4 Pcs)

22 514 0030 

Posteriore - Rear Ape 50 (8 Pezzi - 8 Pcs)

22 514 0050 

Posteriore - Rear Ape Tm P602 (8 Pezzi - 8 Pcs)

22 514 0020 

Anteriore - Front Ape Tmp 602(4 Pezzi - 4 Pcs)

22 514 0040 

Posteriore-Rear Ape Mp-Car-Mpr-Mpv-175 Mp
 (8 Pezzi - 8 Pcs)





POMPE FRENO BRAKE MASTER CYLINDER

22 513 0040 

Ape 50 • P 50 • Tm P50 • 50 FL 2 A 89-95
50 FL 3 Europa 96-98 • Rst Mix 50 A 99
(R.O. 249519)



22 513 0060 

Mp 600 • P 601 A 78-96
(R.O. 140251)



22 513 0080 

Ape Car P 3
(R.O. 1800365)



22 513 0090 

Ape Tm P 703 • P 703 A 84-99 • Tm P 703
P 703-V.Diesel Car • Max Diesel 86-96
(R.O. 249520)



22 513 0100 

Ape Tm P 703 A 84 • Car Diesel A 86-96
(R.O. 179379)



22 513 0110 

Ape Poker • Benzina-Diesel A 93
(R.O. 265195)



22 513 0120 

Cosa 1-2
(R.O. 229254)



22 513 0130 

Ape Tm P602 82-83
(R.O. 197433)



22 513 0140 

220: Ape Car P2 seconda serie-P3 1 serie
(R.O. 229217)



SERIE GUARNIZIONI CILINDRETTI FRENI - BRAKE CYLINDER GASKET SETS

22 513 0010 

Ape 50

22 513 0030 

Ape Tm P602 P703

22 513 0020 

Ape Pp • Car • Ad1 • 175 Mp



TABELLA APPLICAZIONI POMPE FRENO E CILINDRETTI - BRAKE MASTER CYLINDER AND CYLINDER APPLICATION CHART

MODELLO - MODEL	POMPA FRENO MASTER CYLINDER	CILINDRETTO POST. DX REAR RH CYLINDER	CILINDRETTO POST. SX REAR LH CYLINDER	CILINDRETTO ANT. FRONT CYLINDER
Ape 50 • P 50 • Tm P50 • 50 FL 2 A 89-95 • 50 FL 3 Europa 96-98 • Rst Mix 50 A 99	22 513 0040 (R.O. 249519)	22 514 0070 (R.O. 1745292)	22 514 0070 (R.O. 1745292)	
Ape 50 1 Serie		22 514 0060 (R.O. 117446)	22 514 0060 (R.O. 117446)	
Ape 50 • FL • FL 2 A 89-95 • FL 3 Europa A 96-99 • Rst Mix A 99-05	22 513 0040 (R.O. 249519)	22 514 0150 (R.O. 2457652)	22 514 0150 (R.O. 2457652)	
Ape 175 Mp		22 514 0080 (R.O. '076031)	22 514 0090 (R.O. '076032)	
Mp 600 • P 601 A 78-96	22 513 0060 (R.O. 140251)	22 514 0110 (R.O. 137894)	22 514 0110 (R.O. 137894)	22 514 0100 (R.O. 137891)
Ape Car P 3	22 513 0080 (R.O. 1800365)	22 514 0130 (R.O. 245193)	22 514 0130 (R.O. 245193)	22 514 0120 (R.O. 245194)
Ape Tm P 703 • P 703 A 84-99 • Tm P 703 • P 703 V.Diesel Car • Max Diesel 86-96	22 513 0090 (R.O. 249520)	22 514 0130 (R.O. 245193)	22 514 0130 (R.O. 245193)	22 514 0120 (R.O. 245194)
Ape Tm P 703 A.84 • Car Diesel A.86-96	22 513 0100 (R.O. 179379)	22 514 0130 (R.O. 245193)	22 514 0130 (R.O. 245193)	22 514 0120 (R.O. 245194)
Ape Poker • Benzina-Diesel A.93	22 513 0110 (R.O. 265195)	22 514 0140 (R.O. 227549)	22 514 0140 (R.O. 227549)	
Ape Tm P 602	22 513 0130 (R.O. 197433)	22 514 0130 (R.O. 245193)	-	-
Cosa 1 - Cosa 2	22 513 0120 (R.O. 229254)		22 514 0170 (R.O. 228828)	22 514 0160 (R.O. 248846)



22 508 5020 

TAMBURO FRENO POSTERIORE
REAR BRAKE DRUM
PIAGGIO: Vespa 50 Special • Elestart
Vespa 125 Primavera • Et3
(R.O. 100412)



22 508 5040 

TAMBURO FRENO POST. MOZZO 27 mm
REAR BRAKE DRUM HUB 27 mm
PIAGGIO 125-150-200: Vespa Px
Sprint GL • Rally
(R.O. 078480)



22 508 5050 

TAMBURO FRENO POST. MOZZO 30 mm
REAR BRAKE DRUM HUB 30 mm
PIAGGIO: Vespa Pxe Arcobaleno
125-150-200 81-97
(R.O. 194433)



22 508 5080 

TAMBURO FRENO POSTERIORE MOZZO
31,5 mm
REAR BRAKE DRUM HUB 31,5 mm
PIAGGIO: Vespa T5 e Px 11
(R.O. 2427724)



22 508 5070 

TAMBURO FRENO POSTERIORE
REAR BRAKE DRUM
PIAGGIO: Vespa 150 Super - P 150 S
Vbc1, Vnc1
(R.O. 110375-157743)



12 195 0060 

MOLLA GANASCIA
BRAKE SHOES SPRING
PIAGGIO: Vespa 50 • Pk
(R.O. 025990)



12 195 0070 

MOLLA GANASCIA
BRAKE SHOES SPRING
PIAGGIO: Vespa 50- Px 125-150-200
(R.O. 078522)



12 195 0080 

ANELLO GANASCIA
BRAKE SHOES CLIP
PIAGGIO: Vespa
(R.O. 000061)



12 195 0100 

MOLLA PEDALE FRENO
BRAKE PEDAL SPRING
Vespa 50-90-125 Primavera • Et3
(R.O. 70994)



22 508 4000 

TAPPO IN ACCIAIO PER TAMBURRO POST. Ø 39
INOX REAR DRUM PLUG Ø 39
PIAGGIO: Vespa
(R.O. 182546)



22 508 4010 

TAPPO IN ACCIAIO PER TAMBURRO ANT. Ø 32
INOX REAR DRUM PLUG Ø 32
PIAGGIO: Vespa • Ape 50
(R.O. 181757)



22 508 4023 

TAPPO TAMBURRO - DRUM PLUG
Vespa PX 125-150-200
VNX-VLX-VSX
Plastica/Plastic Type
(R.O. 198015)





CERCHI RUOTA PIAGGIO VESPA

PIAGGIO VESPA WHEEL RIMS

22 500 0010



COLORE GRIGIO ORIGINALE

ORIGINAL GRAY COLOR

Vespa 50- Special-Elestart-FL2 • N-Hp-Pk-125
Primavera-Et3 • Gtr-GL Sprint-Sprint Veloce
Ts 125-Px-Pe-Rally 200 Px 11
(3.50-10")
(R.O. 137757-84631)



22 500 0011



COLORE NERO - BLACK COLOR

Vespa 50- Special-Elestart-FL2 • N-Hp-Pk-125
Primavera-Et3 • Gtr-GL Sprint-Sprint Veloce
Ts 125-Px-Pe-Rally 200 Px 11
(3.50-10")



22 500 0015



COLORE BIANCO - WHITE COLOR

Vespa 50- Special-Elestart-FL2 • N-Hp-Pk-125
Primavera-Et3 • Gtr-GL Sprint-Sprint Veloce
Ts 125-Px-Pe-Rally 200 Px 11
(3.50-10")



22 500 0016



CROMATO - CHROMED

Vespa 50- Special-Elestart-FL2 • N-Hp-Pk-125
Primavera-Et3 • Gtr-GL Sprint-Sprint Veloce
Ts 125-Px-Pe-Rally 200 Px 11
(3.50-10")
(R.O. 610120M)



22 500 0017



CROMATO LUSO - TOP QUALITY CHROMED

Vespa 50- Special-Elestart-FL2 • N-Hp-Pk-125
Primavera-Et3 • Gtr-GL Sprint-Sprint Veloce
Ts 125-Px-Pe-Rally 200 Px 11
(3.50-10")
(R.O. 610120M)



22 500 0013



COLORE ROSSO - RED COLOR

Vespa 50- Special-Elestart-FL2 • N-Hp-Pk-125
Primavera-Et3 • Gtr-GL Sprint-Sprint Veloce
Ts 125-Px-Pe-Rally 200 Px 11
(3.50-10")



22 500 0012



COLORE GRIGIO ORIGINALE

ORIGINAL GRAY COLOR

Vespa 50- Special-Elestart-FL2 • N-Hp-Pk-125
Primavera-Et3 • Gtr-GL Sprint-Sprint Veloce
Ts 125-Px-Pe-Rally 200 Px 11
(3.50-10")
Prodotto in India - *Made in India*
(R.O. 137757-84631)



22 500 0018



Vespa 150 VL1/2/3 • Vb1 • Vba1 • Vbb1/2 •
Vespa 125 V30 • V33 • Vm1/2 • Vu1T • Vn1/2 •
Vna 1/2 • Vnb1/2/3/4/5/6
(3.50-8")
(R.O. 014984)





12 157 0050 

PIAGGIO 50: Vespa Pk FL2
(R.O. 266303)



12 157 0070 

PIAGGIO 50: Vespa Et2 97-01 • Et4 00-01
125: Et4 96-01 • **150:** Et4 99-01
(R.O.5649775)

12 157 0080 

PIAGGIO 50: Vespa Rush • N • Pk
125: Pk XL - (R.O. 265752)



12 157 0090 

PIAGGIO 125-150: Vespa Px • **200:** Vespa PE
Fino al 1981 con perno Ø 16 mm
Until 1981 with Ø 16 mm axle
(R.O. 183435)



12 157 0100 

PIAGGIO 125-150: Vespa Px • **200:** Vespa Pe
Dal 1982 con perno Ø 20 mm
From 1982 with Ø 20 mm axle
(R.O. 178050)



12 157 0110 

PIAGGIO 50: Vespa Pk Automatica
Plurimatic - (R.O. 244830)



12 157 0120 

PIAGGIO 125: Vespa Px Arc. 83> • **150:** Vespa
Px Arc. 83> • **200:** Vespa Px Arc. 83>
Con perno Ø 22 mm - *With Ø 22 mm axle*
(R.O.216744)



12 157 0130 

PIAGGIO 125: Vespa T5
(R.O. 232923)



12 157 0150 

PIAGGIO 50-125: Vespa Primavera Et3
(R.O.183678)



12 157 0160 

PIAGGIO 150: Vespa Super ruota 8" - *Wheel 8"*
(R.O. 152332)



12 157 0170 

PIAGGIO 150: Vespa Sprint ruota 10" - *Wheel 10"*
(R.O. 152339)





TESTE E STELI FORCELLE FRONT FORK AND STEERING STEM COUPLE

12 157 0580 

GILERA 50: Dna 00-02 • Dna Gp Experience 03-04 • **125:** Dna 01 • **180:** Dna 01 (R.O. 497050)



12 157 0200 

MBK 50: Cw R Booster Road 94-95 • Cw Booster Spirit 96-98 (R.O. 4PAF33400000 • 4VUF33400000)

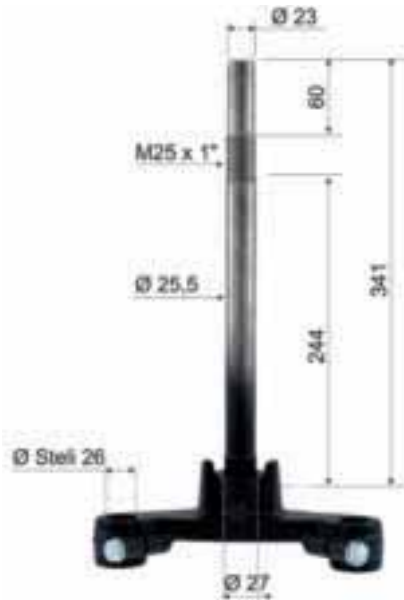

12 157 0470 

MBK 50: Cw Booster 04
YAMAHA 50: Bw's 04-12 • Cw L Bw's 04 • Bw's Naked 04 • Bw's Naked 09-16 (R.O. 4WWF33400000)



12 157 0190 

MBK 50: Cw Rs Booster Ng 95-03 • Cw Rst Booster Rocket 97-98 • Yq Nitro 97-00
YAMAHA 50: Bw's Next Generation 99-06 • Cw Rs Spy 95-98 • Yq Aerox 97-02 • Yq Aerox R 99-00 (R.O. 5BRF33400200)

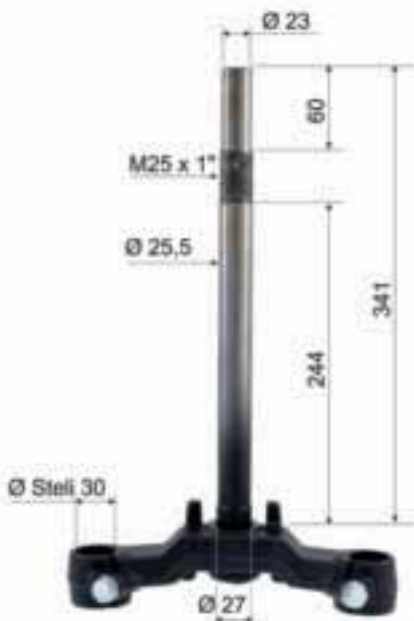

12 157 0180 

MALAGUTI 50: F12 Restyling 06 • F12 Lc Restyling 06 • F12 Phantom Lc 99-04 • F12 Phantom Restyling 01-04 • F12 Phantom 94-98 • F15 Fire Fox 96-06 • F15 Lc Restyling 01-05
100: F12 Phantom 99-00 (R.O. 12030199)



12 157 0460 

HONDA 125-150: Sh 01-12 (R.O. 53219-KPR-900 • 53219-KPR-901)





12 157 0490 

HONDA 125-150: Sh ie 13-16
(R.O. 53219-K01-900)

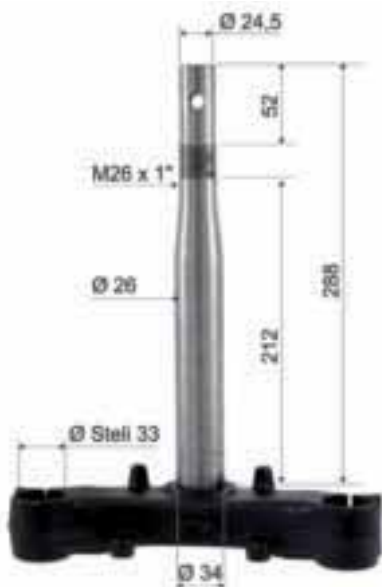

12 157 0480 

HONDA 300: Sh 07-15
(R.O. 53219-KTW-900)



12 158 0060 

COPPIA STELI FORCELLA - INNER TUBES
MBK 50-100: Ovetto 97-00
YAMAHA 50-100: Neo's 97-00
Per Forcella Paioli - For Paioli Fork
(R.O. 5ADF3110)

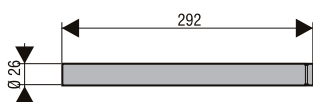

12 158 0070 

COPPIA STELI FORCELLA - INNER TUBES
MBK 50: Booster Spirit 99 • Spirit kat 99-00
YAMAHA 50: Bw's Original e kat 99/00
Per Forcella KYB - For KYB fork
(R.O. 4VUF3110)



12 157 0810 

BRACCIO SOSPENSIONE Ø22 MM ASSE
AXLE ARM SUSPENSION
PIAGGIO 125-150-200: Vespa Px-Pxe Arcobale-
no-VNX-VLX-VSX-VNX2-VLX2-VSX2
(R.O. 178051)



22 518 0180 

ASSE RUOTA ANTERIORE - FRONT AXLE
PIAGGIO 50-90-125: Vespa Primavera -Et3-
V5A2T-V5B1T-VMA2-V9A1
(R.O. 100483)





KIT PERNO SOSPENSIONE ANTERIORE FRONT SUSPENSION PIN

**22 518 0020**

PIAGGIO: Vespa 50 • Pk 50 • Pk 50S • Pk 50
XL • 125 Primavera • 125 ET3
Gabbia - *Cage* 90457 • Perno - *Pin* 70181

22 518 0030

PIAGGIO: Vespa Px • Pe > 82
2 Gabbie - *Cages* Ø 12 x 18 x 12
2 Guarnizioni - *Gaskets*
1 Perno - *Pin* Ø 12 x 50
(R.O.174099 • 138725 • 174098)

22 518 0040

PIAGGIO: Vespa Pk 50 • Rush • N • HP • FL
Pk 125 • ET4 • Sfera • Quartz • Zip Sp 96
Skipper • Exagon • Px • PE 82> • Cosa • 1 • 2
2 Gabbie - *Cages* Ø 16 x 22 x 14
2 Guarnizioni - *Gaskets*
1 Perno - *Pin* Ø 16 x 56
(R.O. 137146 • 119219 • 177451)

22 518 0060

PIAGGIO: Vespa 125-150 dal 1963 • Ape 50
2 Gabbie - *Cages* Ø 12 x 20 x 12
2 Rondelle - *Washer* Ø 12 x 23 x 2
1 Perno - *Pin* Ø 12 x 104

22 518 0170

PIAGGIO: Vespa Sprint 125-150-180-200
(R.O. 091621)

22 518 0070

PIAGGIO 50-250: Ape
2 Gabbie - *Cages* Ø 16 x 22 x 14
2 Guarnizioni - *Gaskets*
1 Perno - *Pin* Ø 16 x 71
Perno per ingrassaggio - *With nipple grease*
(R.O.154676)

22 518 0080

PIAGGIO: Ape P 50 •
2 Gabbie - *Cages* Ø 16 x 22 x 14
2 Guarnizioni - *Gaskets*
1 perno - *Pin* Ø 16 x 75

22 518 0090

PIAGGIO 50: Ape P
2 Gabbie - *Cages* Ø 16 x 22 x 14
2 Guarnizioni - *Gaskets*
1 Perno - *Pin* 16 x 75
Perno per ingrassaggio - *With nipple grease*

22 518 0110

PIAGGIO: Ape Mp
2 Gabbie - *Cages* Ø 18 x 24 x 13
2 Guarnizioni - *Gaskets*
1 Perno - *Pin* 18 x 74
Perno per ingrassaggio - *With nipple grease*

22 518 0130

PIAGGIO: Ape Car • Ape 501 • 601 V
2 Gabbie - *Cages* Ø 18 x 24 x 13
2 Guarnizioni - *Gaskets*
1 Perno - *Pin* 18 x 84

22 518 0140

PIAGGIO: Ape Tm • P 602 Ultimo tipo
2 Gabbie - *Cages* Ø 18 x 24 x 15
2 Guarnizioni - *Gaskets*
1 Perno - *Pin* 18 x 91

22 518 0150

PIAGGIO: Ape Tm - P 602 Ultimo tipo
2 Gabbie - *Cages* Ø 18 x 24 x 15
2 Guarnizioni - *Gaskets*
1 Perno - *Pin* 18 x 91
Perno per ingrassaggio - *With nipple grease*



APRILIA

18 422 0010 

SUPERIORE - UPPER

50: Sport City One 2T 08-11
 (R.O. 56002R)



18 422 0020 

INFERIORE - LOWER

50: Sport City One 2T 08-11
 (R.O. 56003R)



18 422 0100 

COMPLETA - COMPLETE

50: Sport City One 2T 08-11
 (R.O. 56002R+56003R)



18 422 0140 

COMPLETA - COMPLETE

50: Area 51 98-00 • Gulliver 95-98 • Gulliver Lc 96-98 • Rally 95-03 • Rally Liquid Cooled 96-99 • Scarabeo 93-05 • Scarabeo Street 05-06 • Scarabeo Street 2T Rst 06-09 • Scarabeo 2T Net 09-10 • Scarabeo 4T 4V Net 10-12 • Sr 93-96 • Sr Www 97-01 • Sr Street 03-12 • Sr Ditech Eu2 02-04 • Sr H2O Ditech E Carb 00-04 • Sr Liquid Cooled 94-96 • Sr Stealth, Racing 97-99
100: Scarabeo 4T 10-12 • Scarabeo 4T Net / Eu3 10
 (R.O. AP8203666)



18 422 0300 

SUPERIORE - UPPER

50: Sport City One 4T 50 08-10
125: Sport City One 4T Eu3 08-11
 (R.O. CM061303)



18 422 0350 

COMPLETA - COMPLETE

125: Leonardo 96-02 • Leonardo ST 01-04 • Sport City 04-06 • Scarabeo 03-06 • Scarabeo Eu 3 06-07 • Scarabeo Mot. Rotax 99-04 Sport City 04-06 • Sport City Eu 3 06-08 Sport City Cube 08-10 • Sport City Street 12
150: Leonardo 96-02 • Scarabeo 96-02
200: Sport City 04-06 • Scarabeo 96-02
250: Leonardo 99-04 • Leonardo St 01 • Sport City Cube 08-10
300: Sport City Street 12
500: Atlantic 01-04
 (R.O. AP8123794/8123685)



CPI

18 422 0450 

COMPLETA - COMPLETE

250: Scarabeo Light 06-08
300: Scarabeo Light 09-10
400: Scarabeo Light 06-08
 (R.O. 6008725)



18 422 0380 

COMPLETA - COMPLETE

50: Aragon 2T



18 422 0480 

COMPLETA - COMPLETE

50: Gtr Lc - Hussar - Oliver - Popcorn





SERIE CALOTTE STERZO
STEERING HEAD BEARING SET

DERBI

18 422 0010

SUPERIORE - UPPER

50: Gp1 Open Eu2 06-09
125: Gp1 Eu2 06 • Gp1 Low Seat Eu3 07-08
125-150: Boulevard 02-04 • Boulevard Eu3 04-07
200: Boulevard 05
250: Gp1 06-07 • Gp1 Low Seat Eu3 07-08
(R.O. 56002R)



18 422 0020

INFERIORE - LOWER

50: Gp1 Open Eu2 06-09
125: Gp1 Eu2 06 • Gp1 Low Seat Eu3 07-08
125-150: Boulevard 02-04 • Boulevard Eu3 04-07
200: Boulevard 05
250: Gp1 06-07 • Gp1 Low Seat Eu3 07-08
(R.O. 56003R)



18 422 0100

COMPLETA - COMPLETE

50: Gp1 Open Eu2 06-09
125: Gp1 Eu2 06 • Gp1 Low Seat Eu3 07-08
125-150: Boulevard 02-04 • Boulevard Eu3 04-07
200: Boulevard 05
250: Gp1 06-07 • Gp1 Low Seat Eu3 07-08
(R.O. 56002R+56003R)



GILERA

18 422 0300

SUPERIORE - UPPER

50: Boulevard 2T 09-12 • Boulevard 4T Eu2 09
125: Variant Sport 4T E3 12
125-150: Boulevard 4T Eu3 08-12
(R.O. CM061303)



18 422 0010

SUPERIORE - UPPER

50: Easy Moving 95-96 • Ice 01-05 • Runner 97-00
• Runner Poggiali 02 • Runner Purejet 02-06 •
Runner Sp 02-04 • Stalker 97-04 • Storm 94-95 •
Typhoon 94-97 • Typhoon X 98-99 • Typhoon Xr 00
125: Typhoon 95-98 • Typhoon X-Xr 99-00
125-180:
Runner Fx-Fxr 97-02
125-180-200:
Runner Vx Vxr 00-04
(R.O. 56002R)



18 422 0020

INFERIORE - LOWER

50: Easy Moving 95-96 • Ice 01-05 • Runner 97-00 •
Runner Poggiali 02 • Runner Purejet 02-06 • Runner
Sp 02-04 • Stalker 97-04 • Storm 94-95 • Typhoon
94-97 • Typhoon X 98-99 • Typhoon Xr 00
125: Typhoon 95-98 • Typhoon X-Xr 99-00
125-180: Runner Fx-Fxr 97-02
125-180-200: Runner Vx Vxr 00-04
(R.O. 56003R)



18 422 0100

COMPLETA - COMPLETE

50: Easy Moving 95-96 • Ice 01-05 • Runner 97-00
• Runner Poggiali 02 • Runner Purejet 02-06 •
Runner Sp 02-04 • Stalker 97-04 • Storm 94-95 •
Typhoon 94-97 • Typhoon X 98-99 • Typhoon Xr 00
125: Typhoon 95-98 • Typhoon X-Xr 99-00
125-180: Runner Fx-Fxr 97-02
125-180-200: Runner Vx Vxr 00-04
(R.O. 56002R+56003R)



18 422 0300

SUPERIORE - UPPER

50: Runner Purejet 07 • Runner Purejet St 08 •
Runner Sp 05-07 • Runner Sp Special Edition
07 • Runner Sp St & Simoncelli 08-09 • Stalker
05-11 • Stalker Naked 08 • Stalker Special
Edition 07-08 • Storm Eu2 07
125: Runner Vx 05-06 • Runner Vx 4T Eu3
06-07 • Runner Vx 4T St Eu3 08-10 • Runner Vx
Race 06 • Runner Vx Sc 06-07
200: Runner Vxr 05-06 • Runner Vxr 4T St Eu3
08-09 • Runner Vxr Eu3 07 • Runner Vxr Race 06
500: Fuoco Eu 3 07-11
(R.O. CM061303)



18 422 0510

COMPLETA - COMPLETE

125: Nexus Eu3 le 08 • Nexus Eu3 07-08
300: Nexus Eu3 08
(R.O. 6009215)





GILERA

18 422 0520 

COMPLETA - COMPLETE

500: Fuoco Eu3 07-13
(R.O. 6019175)



18 422 0540 

COMPLETA - COMPLETE

500: Fuoco 4T-4V Ie Eu3 13
(R.O. 6670825)



HONDA

18 422 0170 

COMPLETA - COMPLETE

50: Sky



18 422 0180 

COMPLETA - COMPLETE

50: Sh 96>



18 422 0260 

COMPLETA - COMPLETE

125-150: @ • Dylan • Sh



18 422 0322 

SUPERIORE - UPPER

400: Silver Wing



NTN

18 422 0332 

INFERIORE - LOWER

400: Silver Wing



NTN

18 422 0342 

NTN

18 422 0340 

COMPLETA - COMPLETE

400: Silver Wing





SERIE CALOTTE STERZO
STEERING HEAD BEARING SET

HONDA

18 422 0360 

COMPLETA - COMPLETE
125-150: Pantheon 2T/4T
250: Foresight



18 422 0370 

COMPLETA - COMPLETE
300: Sh 08-10



ITALJET

18 422 0270 

COMPLETA - COMPLETE
50-125-150: Torpedo



KYMCO

18 422 0200 

COMPLETA - COMPLETE
50: B&W 02 • Dink 98-02 • Dink Classic Eu2 03 • Heroism 95-97 • People 99
125: B&W 00 • B&W Eu2 00 • Dink 97-98 • Dink Lx 98-00 • Grand Dink 01-02 • Heroism 95-97 • Movie 99-00 • Movie XI 01 • People 99-00 • People Eu2 03 • Vivio 00
150: B&W 00 • B&W Eu2 00 • Dink 97-98 • Dink Lx 98-00 • Grand Dink 01-02 • Heroism 95-97 • Movie 99-00 • Movie XI 01 • People 99-00 • People Eu2 03 • Vivio 00
250: B&W 00 • Grand Dink 01-02 • People 0'03 • Yup 03



18 422 0210 

COMPLETA - COMPLETE
50: Cx 93 • Cx Super 94-97 • Dj W 94-00 • Dj X 91-92 • Djy 93 • Fever Zx 99-00 • Fever Zx Eu2 03-04 • Filly 98-00 • Filly Lx 01-02 • K12 95-00 • Kb 95-00 • Sniper 93 • Sniper Dd 94-96 • Super 9 00 • Super 9 Sport Eu2 03-04 • Top Boy 97-00 • Vitality 2T 04 • Vitality 4T 04 • Yup 02 • Yup Eu2 03 (R.O. 155027)



18 422 0322 

SUPERIORE - UPPER
125: Downtown I 09 • Gran Dink 12 • K-Xcti 12 People Gti 10
200: Downtown I 10 • People Gti 10
250: People S i 07 • People S 06 • Venox Eu3 07 • X Citing I 05-07
300: Downtown I/Abs/Abs i 09-11 • Grand Dink 12 • K Xcti 12 • People Gti / Abs 10-12 • People S I 08 • X Citing I/R 08-09
400: X Citing I 13
500: X Citing I/R 05-09
700: My Road I 11 (R.O. 00155125)



NTN

18 422 0332 

INFERIORE - LOWER
125: Downtown I 09 • Gran Dink 12 • K-Xcti 12 People Gti 10
200: Downtown I 10 • People Gti 10
250: People S i 07 • People S 06 • Venox Eu3 07 • X Citing I 05-07
300: Downtown I/Abs/Abs i 09-11 • Grand Dink 12 • K Xcti 12 • People Gti / Abs 10-12 • People S I 08 • X Citing I/R 08-09
400: X Citing I 13
500: X Citing I/R 05-09
700: My Road I 11 (R.O. 00155125)



NTN

18 422 0342 

COMPLETA - COMPLETE
125: Downtown I 09 • Gran Dink 12 • K-Xcti 12 People Gti 10
200: Downtown I 10 • People Gti 10
250: People S i 07 • People S 06 • Venox Eu3 07 • X Citing I 05-07
300: Downtown I/Abs/Abs i 09-11 • Grand Dink 12 • K Xcti 12 • People Gti / Abs 10-12 • People S I 08 • X Citing I/R 08-09
400: X Citing I 13
500: X Citing I/R 05-09
700: My Road I 11 (R.O. 00155125)



NTN

18 422 0460 

COMPLETA - COMPLETE
50-125-150: Agility 08-12





MALAGUTI

18 422 0230 

SUPERIORE - UPPER

50: Ciak 99-00 • Ciak Master 04 • Ciak Master Eu2 06 • Ciak Mono Eu2 03 • Ciak Mono Eu2 2.3 03 • Ciak Td 00-01 • F10 Ac 08 • F10 Ac Eco 09 • F10 Jet Line 92-98 • F10 Kat 99-00 • F10 Rst Eu1 01-02 • F10 Rst Eu2-2.3 03-04 • F10 Rst Eu2 06 • F10 Rst Eu2 02-03 • Yesterday Euro 97-00



18 422 0240 

INFERIORE - LOWER

50: Ciak 99-00 • Ciak Master 04 • Ciak Master Eu2 06 • Ciak Mono Eu2 03 • Ciak Mono Eu2 2.3 03 • Ciak Td 00-01 • F10 Ac 08 • F10 Ac Eco 09 • F10 Jet Line 92-98 • F10 Kat 99-00 • F10 Rst Eu1 01-02 • F10 Rst Eu2-2.3 03-04 • F10 Rst Eu2 06 • F10 Rst Eu2 02-03 • Yesterday Euro 97-00



18 422 0150 

COMPLETA - COMPLETE

50: Ciak 99-00 • Ciak Master 04 • Ciak Master 4T 05-06 • Ciak Master Eu2 06 • Ciak Mono Eu2 03 • Ciak Mono Eu2 2.3 03 • Ciak Td 00-01 • F10 Ac 08 • F10 Ac Eco 09 • F10 Jet Line 92-98 • F10 Kat 99-00 • F10 Rst Eu2-2.3 03-04 • F10 Rst Eu2 06 • F10 Rst Eu2 02-03 • Yesterday Euro 97-00



18 422 0220 

COMPLETA - COMPLETE

50: Crosser Cr1 95-98 • F10 Rst Eu1 01-02 • F12 Aria Rst Eu2 06 • F12 Lc Rst Eu2 06 • F12 Phantom 94-98 • F12 Phantom Eu1 99-00 • F12 Phantom Lc 94-98 • F12 Phantom Lc Eu1 99-00 • F12 Phantom Lc Rst Eu1 01-02 • F12 Phantom Lc Rst Eu2 02 • F12 Phantom Lc Rst Eu2-2.3 03-04 • F12 Phantom Lc Twin Disks 98 • F15 Fire Fox 96-98 • F15 Fire Fox Air Cooled 05-06 • F15 Fire Fox Eu2 02-03 • F15 Fire Fox Rst Eu2-2.3 03-04 • F15 Fire Fox Twin Disks & Special 98-99 • F15 Fire Fox Digit Kat 98-00 • F15 Lc Rst Eu2 04-05 • F15 Lc-Tds Rst Eu1 01
(R.O. 10401700)



18 422 0310 

COMPLETA - COMPLETE

50: Centro 4T 08 • Centro Sl 4T 10 • F12R Phantom Ac 07-10 • F12R Phantom Lc 07-10
100: Ciak 99-00
125: Blog le 09-11 • Centro le 08-09 • Centro Sl le 09-11 • Ciak 00-01 • Ciak Master 04 • Ciak Master Eu3 06 • Ciak Rst Eu2 03 • F18 Warrior 00-02 • Madison 3 06-09 • Phantom Max 03
150: Ciak 00-02 • Ciak Master 04 • F18 Warrior 00-02 • Ciak Restyling Eu2 03
160: Blog le 09-11 • Centro le 09-11 • Centro Sl le 09
200: Ciak Master Eu2 06 • Phantom Max 03
250: Madison 3 06-09 • Phantom Max 04
(R.O. 10403000)



MBK

18 422 0230 

SUPERIORE - UPPER

50: Booster 90-04 • Booster Road (Ita) 94-95 • Evolis 92-95 • Fizz 94-95 • Forte (Che-Ita) 94-96 • 02-03 • New Sorriso 95-96 • Nitro Jaguar 04 • Nitro Eu2 03 • Nitro 02-04 • Ovetto Eu1-Eu2 02-04 • Sorriso 91-95 • Stunt 00-02 • Target 91-95 • Mach G Eu1/2 02-04
100: Booster 99-01 • Nitro 00-02
125: Flame /F/R 95-00 • Doodo 00-01 • Thunder 01-02 • Skyliner 98-03
150: Vertex 97 • Doodo 01-02 • Thunder 01-02 • Skyliner 00-02
180: Skyliner 03
250: Skyliner 00-03
Skyliner Abs 03
300: Kilibre 03



18 422 0240 

INFERIORE - LOWER

50: Booster 90-04 • Booster Road (Ita) 94-95 • Evolis 92-95 • Fizz 94-95 • Forte 94-96 • New Sorriso 95-96 • Ovetto Eu1-Eu2 02-04 • Sorriso 91-95 • Target 91-95 • Mach G Eu1/2 02-04



18 422 0150 

COMPLETA - COMPLETE

50: Booster 90-04 • Booster Road (Ita) 94-95 • Evolis 92-95 • Fizz 94-95 • Forte 94-96 • New Sorriso 95-96 • Mach Eu1/2 02-04 • Ovetto Eu1-Eu2 02-04 • Sorriso 91-95 • Target 91-95





SERIE CALOTTE STERZO
STEERING HEAD BEARING SET

MBK

18 422 0250 

INFERIORE - LOWER

50: Nitro 02-04 • Nitro Eu2 03 • Stunt 00-02
Nitro Jaguar 04

100: Nitro 00-02

125: Doodo 00-01 • Thunder 01-02 • Skyliner
98-03

150: Doodo 00-01 • Skyliner 00-02 • Thunder
01-02

180: Skyliner 03



18 422 0280 

COMPLETA - COMPLETE

50: Nitro 01-04 • Nitro Eu2 03 • Nitro Jaguar 04
• Stunt 00-02

100: Nitro 00-02

125: Doodo 00-01 • Skyli-
ner 98-03 • Thunder 01-02

150: Doodo 01-02 • Skyli-
ner 00-02 • Thunder 01-02
• Vertex 97

180: Skyliner 03



18 422 0160 

COMPLETA - COMPLETE

50: Booster 01-03 • Booster Ng 95-03 • Booster
Ng Eu1 99-00 • Booster

Naked 03 • Booster Rocket
97-98 • Booster Spirit 96-00

• Booster Spirit Eu2 02-03

• Booster Track 96-98 •

Flipper 98-02 • Flipper Eu2

03-04 • Flipper Kat 99-00 •

Ovetto 97-01 • Nitro 97-01

100: Ovetto 00-02



PEUGEOT

18 422 0390 

COMPLETA - COMPLETE

100: Booster 99-01

125: Flame /F/R 95-00



18 422 0430 

COMPLETA - COMPLETE

300: Kilibre 03



18 422 0180 

COMPLETA - COMPLETE

50: Metropolis Lm 91 • Sv Geo 50 91-95

100: Sv L 100 98

125: Sv Geo 91-95

(R.O. 704980)



18 422 0290 

COMPLETA - COMPLETE

50: Elyseo 99 • Elystar 03-05 • Jetforce 03 •

Looxor 01-03 • Ludix 04 • Speedfight 01-03 •

Trekker 98-00 • Vivacity 99-00 • **100:** Elyseo 00-

01 • Looxor 01 • Speedfight 97-00 • X-Fight 00

125: Elystar 02-03 • Jetforce 03-04 • Looxor

02-03 • **150:** Elystar 02-03 • Jetforce 03-04 •

Looxor 02-03



18 422 0550 

COMPLETA - COMPLETE

125: Geo C • Es • Exn • Ex • E • Sc • S • X

Sat C • S • Sc • E • Ex • Esc • E Millesim • K15 • K15 Bx •

K15 C • K15 Scx • K15 Sc • K15 Wx • Sat 2 C • S • Sc

250: Geo C • Sc • S • X • Sat C • Es • Ex • E • Nx • Sc • S • X

300: Geo St • Xn • X • Sat 2

400: Geo C • Sc • S • Xn • X • Sat C • Sc • S • Xn • X

500: Geo • Sat C • Sc • S • X



18 422 0560 

COMPLETA - COMPLETE

50: Fight 3 • 3E • 3Lc • 3Lcx • Kisbee • Kisbee U •

Kisbee X • Viva 3L • 2T • 4T

125: Viva 3L 4T • Vivacity





PIAGGIO

18 422 0010

SUPERIORE - UPPER

50: Fly 2T 05-07 • Liberty 97-05 • Liberty 2T Rst 04 • Liberty 4T 00-02 • Liberty 4T Rst 04 • Liberty Ptt Eu2 04-05 • Nrg 94-96 • Nrg Extreme 99-00 • Nrg Power Dd 05 • Nrg Power Purejet 04-05 • Nrg Purejet 02-04 • Nrg Rst Mc2 96-98 • Ntt 95-96 • Quartz 92-96 • Sfera 91-93 • Sfera Maquillage 2 94 • Sfera Rst 95-97 • Typhoon 01-04 • Vespa Et2 Iniez 97-00 • Vespa Et4 00-05 • Vespa Lx 2T Touring 10 • Vespa Lx 4T-4V Touring 10 • Vespa N 89-90 • Vespa Pk Autom 84-89 • Vespa Pk XI 85-88 • Vespa Pk XI Plurimatic 85-90 • Vespa Pk XI Rush 88-89 • Zip 00-04 • Zip 95-96 • Zip 4T 00-05 • Zip Bimodale 94-97 • Zip Fast Raider 93-94 • Zip Fast Raider Rst 96-97 • Zip Rst 96-99 • Zip Sp 96-04

80: Skr City 99 • **100:** Free 02-03

125: Cosa 2 91-97 • Cosa Cl-Clx 88-91 • Hexagon 94-97 • Hexagon Gtx 00 • Hexagon Lx-Lxt 98-99 • Hexagon Lx4 98-99 • Liberty 98-02 • Sfera 95-97 • Skipper 94-97 • Skipper 4T 00-02 • Skipper Lx 98-99 • Super Hexagon Gtx 12" 01-02 • Vespa Et4 96-02 • Vespa Pk XI 86-89 • Vespa Px Eu2 01-07 • Vespa S 4T le 09 • Zip 00-02

200: Liberty Rst 04

250: Hexagon Gt-Gtx 98-00

(R.O. 56002R)



18 422 0020

INFERIORE - LOWER

50: Fly 2T 05-07 • Liberty 97-05 • Liberty 2T Rst 04 • Liberty 4T 00-02 • Liberty 4T Rst 04 • Liberty Ptt Eu2 04-05 • Nrg 94-96 • Nrg Extreme 99-00 • Nrg Power Dd 05 • Nrg Power Purejet 04-05 • Nrg Purejet 02-04 • Nrg Rst Mc2 96-98 • Ntt 95-96 • Quartz 92-96 • Sfera 91-93 • Sfera Maquillage 2 94 • Sfera Rst 95-97 • Typhoon 01-04 • Vespa Et2 Iniez 97-00 • Vespa Et4 00-05 • Vespa Lx 2T Touring 10 • Vespa Lx 4T-4V Touring 10 • Vespa N 89-90 • Vespa Pk Autom 84-89 • Vespa Pk XI 85-88 • Vespa Pk XI Plurimatic 85-90 • Vespa Pk XI Rush 88-89 • Zip 00-04 • Zip 95-96 • Zip 4T 00-05 • Zip Bimodale 94-97 • Zip Fast Raider 93-94 • Zip Fast Raider Rst 96-97 • Zip Rst 96-99 • Zip Sp 96-04

80: Skr City 99 • **100:** Free 02-03

125: Cosa 2 91-97 • Cosa Cl-Clx 88-91 • Hexagon 94-97 • Hexagon Gtx 00 • Hexagon Lx-Lxt 98-99 • Hexagon Lx4 98-99 • Liberty 98-02 • Sfera 95-97 • Skipper 94-97 • Skipper 4T 00-02 • Skipper Lx 98-99 • Super Hexagon Gtx 12" 01-02 • Vespa Et4 96-02 • Vespa Pk XI 86-89 • Vespa Px Eu2 01-07 • Vespa S 4T le 09 • Zip 00-02

200: Liberty Rst 04 • **250:** Hexagon Gt-Gtx 98-00

(R.O. 56003R)



18 422 0100

COMPLETA - COMPLETE

50: Fly 2T 05-07 • Liberty 97-05 • Liberty 2T Rst 04 • Liberty 4T 00-02 • Liberty 4T Rst 04 • Liberty Ptt Eu2 04-05 • Nrg 94-96 • Nrg Extreme 99-00 • Nrg Power Dd 05 • Nrg Power Purejet 04-05 • Nrg Purejet 02-04 • Nrg Rst Mc2 96-98 • Ntt 95-96 • Quartz 92-96 • Sfera 91-93 • Sfera Maquillage 2 94 • Sfera Rst 95-97 • Typhoon 01-04 • Vespa Et2 Iniez 97-00 • Vespa Et4 00-05 • Vespa Lx 2T Touring 10 • Vespa Lx 4T-4V Touring 10 • Vespa N 89-90 • Vespa Pk Autom 84-89 • Vespa Pk XI 85-88 • Vespa Pk XI Plurimatic 85-90 • Vespa Pk XI Rush 88-89 • Zip 00-04 • Zip 95-96 • Zip 4T 00-05 • Zip Bimodale 94-97 • Zip Fast Raider 93-94 • Zip Fast Raider Rst 96-97 • Zip Rst 96-99 • Zip Sp 96-04

80: Skr City 99 • **100:** Free 02-03

125: Cosa 2 91-97 • Cosa Cl-Clx 88-91 • Hexagon 94-97 • Hexagon Gtx 00 • Hexagon Lx-Lxt 98-99 • Hexagon Lx4 98-99 • Liberty 98-02 • Sfera 95-97 • Skipper 94-97 • Skipper 4T 00-02 • Skipper Lx 98-99 • Super Hexagon Gtx 12" 01-02 • Vespa Et4 96-02 • Vespa Pk XI 86-89 • Vespa Px Eu2 01-07 • Vespa S 4T le 09 • Zip 00-02

200: Liberty Rst 04

250: Hexagon Gt-Gtx 98-00

(R.O. 56002R+56003R)



18 422 0300

SUPERIORE - UPPER

50: Fly 4T 05-07 • Fly 4T Motore Chn 06-07 • Liberty 2T 06-08 • Liberty 2T Sport 06-08 • Liberty 4T 05-08 • Liberty 4T Sport 06 • Liberty Moc 4T & Elle 09-11 • Nrg Mc3 01-04 • Nrg Power Dd 06-10 • Nrg Power Dd Serie Speciale 07-08 • Nrg Power Dt 06-08 • Nrg Power Pur Jet 06-09 • Typhoon 05-09 • Vespa 67-82 • Vespa Et2 97-05 • Vespa Lx 2T 05-08 • Vespa Lx 2T Fl 09-10 • Vespa Lx 4T 05-08 • Vespa Lx 4T-4V 09 • Vespa Lxv 2T 06-08 • Vespa Lxv 2T Navy 08 • Vespa Pk 82-84 • Zip 2T 08-10 • Zip 4T 06-08 • Zip Sp Eu2 06-09 • **100:** Fly 4T 06-07 • **125:** Fly 05-07 • Fly Eu3 07 • Liberty 4T 06-07 • Liberty 4T Eu3 07-08 • Liberty 4T Eu3 Delivery 08 • Liberty 4T Sport Eu3 06-08 • Liberty Rst Ptt 05-11 • Liberty Sport 06 • Mp3 07-08 • Mpe le 08-09 • Vespa Granturismo0 03-07 • Vespa Granturismo Eu3 06-07 • Vespa Gts Eu3 07-09 • Vespa Gtv 07-08 • Vespa Gtv 4T Navy Eu3 08 • Vespa Lx 05-06 • Vespa Lx 4T Fl 09 • Vespa Lx Eu3 06-08 • Vespa Lxv 4T Eu3 06-09 • Vespa Lxv 4T Navy Eu3 08 • Vespa Px 98-01 • Vespa Px 30 Anni 07-08 • Vespa Px T5 85-89 • Vespa Pxe Arcobaleno 81-97 • Vespa S 4T Eu3 07-08 • **150:** Fly 05-07 • Liberty 4T Eu3 08 • Liberty 4T Sport Eu3 08 • Liberty Moc 4T 09-10 • Vespa Lx 05-06 • Vespa Lx 4T Fl 09 • Vespa Lx Eu3 06-08 • Vespa S 4T 08-09 • **200:** Liberty 06 • Liberty 4T Eu3 07-08 • Liberty 4T Sport Eu3 06-07 • Liberty Sport 06 • Vespa Granturismo 06-07 • **250:** Mp3 06-08 • Mp3 Lt 09 • Mp3 Mic 08-09 • Vespa Gt 60 Eu3 06-07 • Vespa Gts, Gts Abs 05-10 • Vespa Gtv 06-09 • Vespa Gtv 4T Navy Eu3 08 • **300:** Mp3 300 le Lt 10 • Vespa Gts Super 08-09 • **400:** Mp3 07-08 • Mp3 Mic 08-09

(R.O. CM061303)





SERIE CALOTTE STERZO
STEERING HEAD BEARING SET

PIAGGIO

18 422 0450



COMPLETA - COMPLETE

125: Beverly Eu3 07-08 • Beverly Rst 4T 4V le Eu3 10-13 • Beverly Tourer Eu3 07-10 • Beverly Eu3 Mic /Sport 07-08 • Carnaby 07-10

200: Carnaby 07-08

250: Beverly 06-07

Beverly Cruiser 07-09

Beverly Eu3 Mic 07

Beverly le Eu3 06-08

Beverly Sport 06-08

Beverly Tourer Eu3 08-09

Carnaby 08

300: Beverly Rst 4T 4V

le Eu3 10-13

Beverly Tourer Eu3 09-10

Carnaby Cruiser 09-12

350: Beverly 4T 4V le

Eu3 Sport 11-13

(R.O. 6008725)



18 422 0510



COMPLETA - COMPLETE

125: X7 Eu3 08 • X7 Evo le Eu3 09-10

250: X7 Eu3 08 • X Evo 07-13

300: X7 Evo le Eu3 09-10

400: X8 Eu3 06-08

(R.O. 6009215)



18 422 0110



COMPLETA - COMPLETE

50: Boss 88-89 • Bravo 3 87-90 • Bravo Erre 2 75-81 • Si 79-88 • Si Fl2 91-97 • Si Mix 96-99 • Superbravo 3 87-90

• Superbravo 85-90

(R.O. 564746)



18 422 0270



COMPLETA - COMPLETE

50: Boss 88-89 • Bravo 3 87-90 • Bravo erre

2 75-81 • Free Delivery 00-01 • Free FL 95-02

• Free 92-94 • Si FL2 91-97 • Si Mix 96-99 • Si

79-88 • Superbravo 3 87-90 • Superbravo 85-90

• Zip 92-96

125: Mp3 Ibrido 09

250: Mp3 Mic 08-09 • Mp3 06-08

400: Mp3 Mic 08-11 • Mp3 07-08

(R.O. 564746)



18 422 0520



COMPLETA - COMPLETE

125: Mp3 le 08-09 • Mp3 Ibrido 09-10 > • Mp3

le Touring 11-12 • Mp3 06-08

250: Mp3 Lt 09 • Mp3 Mic 08-09

300: Mp3 le Lt 10-11 • Mp3 le Mic 10-11 •

Mp3 4T 4V le Lt Ibrido 10-11 • Mp3 4T 4V le Erl

Ibrido 10-13 • Mp3 le Lt Touring 11-12 • Mp3 le

Lt - le Lt Sport 11-13 • Mp3 le Touring 11-12

400: Mp3 RL Touring 11 • Mp3 07-08 • Mp3 le

Lt - Mp3 le Lt Sport 08-10 •

Mp3 le Lt Touring 11 • Mp3

Mic 08-11

500: Mp3 Lt Sport - Busi-

ness 11-12 • RL Sport - Busi-

ness 11-12

(R.O. 601957)



18 422 0030



SUPERIORE - UPPER

50: Ape Fl • Fl2 89-95 • Ape Fl3 Europa 96-99

• Ape P 80-85 • Ape Tm P 85-89 • Ape Mix 2T

98-08 • Rst Mix 99-03

(R.O. 493616)



18 422 0040



INFERIORE - LOWER

50: Ape Fl • Fl2 89-95 • Ape Fl3 Europa 96-99

• Ape P 80-85 • Ape Tm P 85-89 • Ape Mix 2T

98-08 • Ape Rst Mix 99-03

(R.O. 493617)



18 422 0050



SUPERIORE - UPPER

220: Ape Car P2-P3 78-85 • Mp P501-P601 78-96

420: Ape Car- Max Diesel 86-96

(R.O. 153507)



18 422 0060



INFERIORE - LOWER

220: Ape Mp P501-P601 78-96

(R.O. 153508)





PIAGGIO

18 422 0080



SUPERIORE - UPPER

220: Ape Tm 09-12 • Ape Tm P602 82-83 • Ape Tm P703-P703V, FI2 84-05

420: Ape Tm D Lcs 05-12 • Ape Tm P703-P703V Diesel 87-04
(R.O. 493618)



18 422 0090



INFERIORE - LOWER

220: Ape Tm 09-12 • Ape Tm P602 82-83 • Ape Tm P703-P703V, FI2 84-05

420: Ape Tm D Lcs 05-12 • Ape Tm P703-P703V Diesel 87-04
(R.O. 493619)



18 422 0540



COMPLETA - COMPLETE

125: Mp3 Yourban Erl 11-12
300: Mp3 Yourban Erl 11•Mp3 Yourban Lt Erl 11-12
(R.O. 6670825)



18 422 0583



COMPLETA - COMPLETE

125: Vespa VNA



18 422 0570



COMPLETA - COMPLETE

50: Ciao
(R.O. 814231)



SCOOTER CINESI

18 422 0470



COMPLETA - COMPLETE

Baotian - Bt50Qt9-Qt12



18 422 0480



COMPLETA - COMPLETE

Baotian - Bt 49 Qt-18
Keeway - F-Act 50-Flash



SUZUKI

18 422 0400



COMPLETA - COMPLETE

125: Marauder 98-10 • Vanvan 03-10
Burgman 02-10 • Intruder 00-07
150: Burgman 02-06
200: Burgman 07-10
250: Burgman 98-06
Marauder 99-07
Intruder 00-07
400: Burgman 99-06





SERIE CALOTTE STERZO
STEERING HEAD BEARING SET

SYM

18 422 0490



COMPLETA - COMPLETE

50: Fiddle II 08 • Fiddle II S 09-13 • Jet 4 09-10 • Jet 4 R2T 11-13 • Symphony 09 • Symphony S 10-12 • Symphony Sr 10-12 • Symply 07-08 • Symply II 09 • X Pro 13
- 125: Eu Mx / E2 02-04 • Fiddle II 08-10 • Jet V 11 • Jet 4 09-10 • Shark 99-02 • Symphony S 09-12 • Symphony Sr 10-12 • Symphony 09 • Symply 07-08 • Symply II 09-10 • Vs Eu3 06-08 • X Pro 13
- 150: Eu Mx / Eu2 02-04 • Fiddle II 10-12 • Shark 00-01 • Symphony 09-12 • Symphony Sr 10-12 • Vs / Eu3 06-08



18 422 0500



COMPLETA - COMPLETE

250: Joymax Eu3 I 07-08
300: Joymax Evo 09 • Evo I 10



YAMAHA

18 422 0230



SUPERIORE - UPPER

50: Aerox 02-11 • Aerox Eu2 03 • Axis 95-96 • Breeze 94-95 • Cts 90-95 • Jog Z 95 • Jog R 02-11 • Jor Eu2 02-05 • Neo'S 02-11 • Neo'S Eu2 02-03 • Neo'S 4 09-11 • Slider 00-02 • Bw's Naked 04-11 • Bw's 04-11 • Crz 91-95
100: Aerox 00-02 • Bw'S 99-01
125: Beluga 90-95 • Cygnus /R 95-03 • X City 08-10 • Maxster 01-02 • Majesty 98-09 • Teo's 00
150: Beluga 01-02 • Cygnus 01-02 • Flyone /R 90-98 • Majesty 00-02 • Maxster 01-02 • Teo'S 01-02
180: Majesty 03-06
250: X City 07-1
Majesty 96-03
Majesty Dx 98-99
Majesty Abs 03
300: Versity 03-06



18 422 0240



INFERIORE - LOWER

50: Axis 95-96 • Bw's Naked 04-11 • Bw's 04-11 • Breeze 94-95 • Crz 91-95 • Cts /Ss 90-95 • Giggie 08 • Jog Z 95 • Jog Eu2 02-05 • Jog R 02-11 • Neo'S 02-11 • Neo'S Eu2 02-03 • Neo's 4 09-11
Slider 02



18 422 0150



COMPLETA - COMPLETE

50: Axis 95-96 • Breeze 94-95 • Bw's Naked 04-11 • Bw's 04-11 • Cts /Ss 90-95 • Crz 91-95 • Jog Z 95 • Jog R Eu2 02-05 • Jog R 02-11 • Neo'S 02-11 • Neo'S Eu2 02-03 • Neo's 4 09-11
Slider 02



18 422 0250



INFERIORE - LOWER

50: Aerox 01-13 • Aerox Eu2 03 • Slider 00-02
Aerox Naked 13
100: Aerox 00-02 • Slider 00-02
125: Majesty 01-05 • X Max 07-09 • Yzfr 08-11 •
150: Majesty 01-02
180: Majesty 03-06
250: X Max 05-09 • Black X Max 09



18 422 0280



COMPLETA - COMPLETE

50: Ew Slider 00-02 • Aerox 01-13
Aerox Eu 2 03 • Aerox Naked 13
100: Aerox 00-02
125: Majesty 98-09 • Maxster 01-02 • Teo's 00
150: Majesty 00 • Maxster 01-02 • Teo's 01-02



18 422 0160



COMPLETA - COMPLETE

50: Bw's bump 97-98 • Bw's Naked 03 • Bw's 03 • Bw's Next Generation 97-06 • Next Generation Kat 99-00 • Bw's Original Eu2 02-05 • Bwis Original 97-02 • Bw's R 01 • Spy 95-98 • Way 98-06 • Way Eu1/2 99-05 • Neo's 97-01 • Aerox R 99-00 • Aerox 97-02
100: Neo's 99-01





YAMAHA

18 422 0400

COMPLETA - COMPLETE

500: T Max Abs 05-07 • T Max 01-07
T Max Black Max / Night Max 06-07



18 422 0410

COMPLETA - COMPLETE

500: T-Max 08-11 • T Max Abs Sv 11 • T Max
Abs 08-11 • T Max Sv 11 • T Max White Max 10



18 422 0430

COMPLETA - COMPLETE

125: Vpx - X-City 08-10
250: X-City 07-11
300: Versity 03-06



18 422 0420

COMPLETA - COMPLETE

125: Yp R X-Max 10-11
• X Max Abs 11
250: X Max 10-11
• X Max Abs Sport 11



18 422 0390

COMPLETA - COMPLETE

100: Bw'S 99-01
125: Bw'S 10 • Beluga 90-95
• Cygnus SX 04-11
• Cygnus R 97-03
• Cygnus 95-98
150: Flyone 90-95
• Flyone R 97-98



18 422 0440

COMPLETA - COMPLETE

125: Xmax 06-09
250: Black X Max 09
• X Max 05-09



GABBIETTE STERZO - GROSSE SFERE - BALL CAGES - BALL SETS



Grosse sfere Conf. (144 Pz.)
Grs ball set (144 Pcs)

18 424 0010

GABBIETTE STERZO SUPERIORE SFERE 1/8"
UPPER BALL CAGES

Conf. 50 pz. • 50 Pcs ball set
PIAGGIO Vespa • (R.O. 077024)

18 424 0200

5 Conf. Grosse sfere **1/8"** (Tot. 720 Pz.)
5 Grs ball set **1/8"** (Tot. 720 Pcs)

18 424 0230

5 Conf. Grosse sfere **7/32"** (Tot. 720 Pz.)
5 Grs ball set **7/32"** (Tot. 720 Pcs)

18 424 0020

GABBIETTE STERZO INFERIORE SFERE 1/4"
LOWER BALL CAGES

Conf. 50 pz. • 50 Pcs ball set
PIAGGIO Vespa • (R.O. 077023)

18 424 0210

5 Conf. Grosse sfere **5/32"** (Tot. 720 Pz.)
5 Grs ball set **5/32"** (Tot. 720 Pcs)

18 424 0240

5 Conf. Grosse sfere **1/4"** (Tot. 720 Pz.)
5 Grs ball set **1/4"** (Tot. 720 Pcs)

18 424 0030

GABBIETTE SUPERIORI 5/32"
UPPER BALL CAGES 5/32"

Conf. 50 pz. (50/Pcs Packing)
per ricambio serie 18 422 0300
for replace 18 422 0300

PIAGGIO-GILERA

18 424 0220

5 Conf. Grosse sfere **3/16"** (Tot. 720 Pz.)
5 Grs ball set **3/16"** (Tot. 720 Pcs)

18 424 0250

5 Conf. Grosse sfere **5/16"** (Tot. 720 Pz.)
5 Grs ball set **5/16"** (Tot. 720 Pcs)

18 424 0260

5 Conf. Grosse sfere **11/32"** (Tot. 720 Pz.)
5 Grs ball set **11/32"** (Tot. 720 Pcs)



DADI - RONDELLE

NUTS - WASHERS

12 185 0200 

DADO FLANGIATO TESTA MOTORE
CYLINDER HEAD NUT

MINARELLI 50

Confezione 10 pz. - 10 Pcs Packing

M 7 x 1

(R.O. 74918300)



12 186 0050 

DADO 9MA - NUT 9 MA

Various Vespa models

Confezione 10 pz. - 10 Pcs Packing

(R.O. 020209)



12 185 0210 

DADO VOLANO M 10X1,25 - FLYWHEEL NUT
MOTORE MINARELLI 50

Confezione 10 pz. - 10 Pcs Packing

(R.O. 74921000)



12 185 0220 

DADO PULEGGIA MOTRICE M10x1,25

DRIVING PULLEY NUT M10x1,25

Confezione 10 pz. - 10 Pcs Packing

MINARELLI YAMAHA 50

(R.O.74918100)

PIAGGIO: Sfera 125 • Et4 • Hexagon Lx4 125 •

Liberty 125 98-00

GILERA: Easy moving • Storm • Typhoon

PIAGGIO: Zip Free tutti • Nrg • Ntt

Sfera 50 • Quartz • Skr City • Nrg Rst Mc2

(R.O. Volano 436789 • Puleggia 021110)



12 185 0230 

DADO CAMPANA

FRIZIONE POSTERIORE Ø 10x1

DRIVEN PULLEY DRUM NUT Ø 10x1

Confezione 10 pz. - 10 Pcs Packing

MINARELLI YAMAHA 50

(R.O. 74920400)



12 186 0320 

DADO PIGNONE - NUT

PIAGGIO 50-90-125: Vespa

125: Primavera • Et3

(R.O. 001508)



12 186 0330 

DADO FRIZIONE - FLYWHEEL NUT

PIAGGIO 125: Vespa Primavera • Et3

(R.O. 001510)



12 185 8460 

DADO PERNO RUOTA - WHEEL PIN NUTS

PIAGGIO 50-90-125: Vespa Primavera

(R.O. 015222)



12 186 0340 

DADO CERCHIO RUOTA - WHEEL NUT

PIAGGIO 125: Vespa

(R.O. 019411)



12 185 5000 

SCODELLINO DADO RUOTA POST./ANT.
REAR FRONT WHEEL SHAFT CAP

Confezione 10 pz. - 10 Pcs Packing

GILERA-PIAGGIO 50-125-150-180-500

Vespa Px • Cosa • Ape

(R.O. 194423)





12 185 0240 

**DADO RUOTA POSTERIORE
AUTOBLOCCANTE M14x1,5**
REAR WHEEL SHAFT SELF LOCK NUT M14x1,5
Confezione 10 pz. - 10 Pcs Packing
MINARELLI YAMAHA 50
MALAGUTI 125-150-250: Madison
(R.O. 1850100)



12 185 0290 

DADO ALBERO PRIMARIO M 9x1,25
PRIMARY SHAFT NUT M 9x1,25
Confezione 10 pz. - 10 Pcs Packing
PIAGGIO 125-150-200: Vespa Pxe Arcobaleno • Px • Px T5 • Cosa 2 • Cosa CL • CLX • Rally
(R.O. 015231)



12 185 0250 

DADO TUBO SCARICO FLANGIATO M 7x1
SILENCER NUT M7x1
Confezione 10 pz. - 10 Pcs Packing
GILERA 125-180: Runner Vx-Vxr 00> Dna
PIAGGIO 125: Sfera • Zip 00
125-150: Skipper 4T • Vespa Et4 99>
125-180: Super Hexagon Gtx
180: X9 Amalfi
(R.O. 436947)



12 185 0340 

**KIT DADO SCODELLINO COPIGLIA
PER ALBERO RUOTA POSTERIORE**
REAR WHEEL SHAFT NUT CAP SET
GILERA-PIAGGIO
(R.O. 194423-563728)



12 185 0270 

DADO VOLANO FLANGIATO M 10x1,25
FLYWHEEL NUT M10x1,25
Confezione 10 pz. - 10 Pcs Packing
GILERA 50: Runner • Stalker • Dna • Ice
PIAGGIO 50: Diesis • Liberty 2T 97-01
Nrg Mc3 • Nrg Extreme • Purejet • Typhoon 01
Vespa Et2 • Et2 iniezione • Et4 00-01 • Zip 00
• Free 100
(R.O. 289005)



12 185 0460 

DADO MOZZO FRIZIONE POSTERIORE
REAR CLUTCH HUB NUT
PIAGGIO 400: Beverly Eu3 06-07 • Mp3 07
Xevo 07-08 • Eu3 06-08
500: Beverly 02-06 • Cruiser Eu3 06-08 • X9 01-02 • Evolution 03-07 • Evolution Abs 06-07



12 185 0310 

DADO MOZZO FRIZIONE POSTERIORE M 28x1
REAR CLUTCH HUB NUT M28x1
Confezione 10 pz. - 10 Pcs Packing
HONDA 125-150: @ • Sh
MINARELLI-YAMAHA-MBK-MALAGUTI 50
(R.O. 74921900)
GILERA-PIAGGIO 50: (R.O. 289955)



12 185 0320 

DADO MOZZO FRIZIONE POSTERIORE M 38x1
REAR CLUTCH HUB NUT M38x1
Confezione 10 pz. - 10 Pcs Packing
PIAGGIO 50: Sfera 91-93 • Zip 92-94
80: Skr City
125: Sfera 95-97 • Liberty 98-00 • Vespa Et4
96-99 • Hexagon Lx4 98>
(R.O. 285017)



12 185 0400 

DADO VOLANO - FLYWHEEL NUT
Confezione 10 pz. - 10 Pcs Packing
PIAGGIO 50-90-125: Vespa Primavera • Et3
(R.O. 001545)



12 185 0350 

DADO ALBERO RUOTA POSTERIORE
REAR WHEEL SHAFT NUT
Confezione 10 pz. - 10 Pcs Packing
GILERA-PIAGGIO 50-125-150-180-250-500
(R.O. 563728)



12 185 0360 

**DADO FRESATO FISSA TAMBURO
RUOTA POSTERIORE**
REAR WHEEL DRUM SECURING NUT
Confezione 2 pz. - 2 Pcs Packing
PIAGGIO 50-90-125: Vespa Et3
(R.O. 002314)



12 185 0390 

DADO CAMPANA FRIZIONE
CLUTCH RING NUT
Confezione 10 pz. - 10 Pcs Packing
PIAGGIO 125-150-200: Vespa Px • Pe
(R.O. 020375)





DADI - RONDELLE

NUTS - WASHERS

12 185 0410 

DADO VOLANO M 12 x 1,25 H 10
FLYWHEEL NUT M 12 x 1,25 H 10

Confezione 10 pz. - 10 Pcs Packing

GILERA 125-180: Runner • Vx-Vxr

125-180: Dna 00>

PIAGGIO 50: Ape tutti i modelli

125: Zip 125-00> • Beverly 00-01

125-150: Skipper 4T • Liberty 01> • Vespa Et4

99> • Px • Pe • Pk Rush • N • FL • Cosa 92-97

125-180: S. Hexagon Gtx 00>

180: X9 Amalfi 00>

(R.O. 486324)



12 185 0430 

DADO TESTA CILINDRO

MARMITTA - CARROZZERIA M6X1

CYLINDER HEAD - MUFFLER - BODYWORK
NUT M6X1

Confezione 10 pz. - 10 Pcs Packing

GILERA-PIAGGIO 50-125-150-180-200-250-500



12 185 0440 

KIT DADO RONDELLA RUOTA POST.

REAR WHEEL SHAFT NUT AND WASHER SET
MINARELLI-YAMAHA 50



12 185 0450 

KIT DADO RONDELLA PULEGGIA MOTRICE
DRIVING PULLEY NUT AND WASHER SET
MINARELLI-YAMAHA 50



12 185 5010 

SCODELLINO FERMA DADO FRIZIONE
CLUTCH RING NUT SECURING WASHER

Confezione 50 pz. - 50 Pcs Packing

PIAGGIO 125-150-200: Vespa Px • Pe • Cosa

(R.O. 22313)



12 185 5050 

RONDELLA PIANA CON INCAVO INTERNO
PER DADO FISSAGGIO RUOTA POSTERIORE
REAR WHEEL SHAFT WASHER

Confezione 10 pz. - 10 Pcs Packing

MINARELLI-YAMAHA 50

Fori interni - *Internal* Ø 14 e Ø 17

Ø esterno - *external* 28

Spessore - *thickness* 5 mm



12 185 5060 

RONDELLA CONICA PER DADO FISSAGGIO
PULEGGIA MOTRICE

DRIVE PULLEY CONICAL WASHER

Confezione 10 pz. - 10 Pcs Packing

MINARELLI-YAMAHA 50



12 185 6050 

BULLONE Ø 6 x 1 - BOLT Ø 6x1

Confezione 20 pz. - 20 Pcs Packing

MINARELLI-YAMAHA 50



12 185 9110 

RONDELLA GROWER IN ALLUMINIO
ALLOY GROWER WASHER

12x20x2 Tappo olio Honda Sh 300

12x20x2 Oil tap Honda Sh 300

Confezione 10 pz. - 10 Pcs Packing



12 185 8620 

COLONNINA CUFFIA - SPACER

PIAGGIO 125-150-200: Vespa Px

Confezione 10 pz. - 10 Pcs Packing

(R.O. 014447)



12 186 0290 

COLONNINA CUFFIA

COOLING HOOD SPACER

PIAGGIO 200: Vespa

Confezione 10 pz. - 10 Pcs Packing

(R.O. 015239)





12 185 0260 

Dado M10x1,25 - Nut

Confezione 10 pz. - 10 Pcs Packing
(R.O. 289519)



DADO M 10 X 1,25 - NUT	PULEGGIA CONDOTTA DRIVEN PULLEY	MOTRICE DRIVING PULLEY	VOLANO FLYWHEEL
GILERA 50:			
Dna 00-01	•	•	
Easy Moving 95-96	•	•	
Runner 97-00	•	•	
Storm 94-95	•	•	
Stalker 97-01	•	•	
Typhoon X 98-99	•	•	
Typhoon XR 00	•	•	
Typhoon 94-97	•	•	
PIAGGIO 50:			
Diesis 01	•	•	
Free 92>	•	•	
Free delivery 00>	•	•	
Liberty 4T 00>	•	•	•
Liberty 2T 97>	•	•	
Nrg 94-96	•	•	
Nrg Mc3 01	•	•	
Nrg Extreme 99-00	•	•	
PIAGGIO 50:			
Nrg Rst Mc2 96-98	•	•	
Ntt 95-96	•	•	
Quartz 92-96	•	•	
Sfera base 91-93	•	•	
Sfera Maquillage 2 94	•	•	
Sfera Rst 95-97	•	•	
Typhoon 01	•	•	
Velofax 96-99	•	•	
Vespa Et4 00-01	•	•	
Vespa Et2 97-01	•	•	
Vespa Et2 iniezione	•	•	
Zip Rst 96-99	•	•	
Zip fast Raider 93-97	•	•	
Zip SP 96-97	•	•	
Zip Base 92-94	•	•	
Zip 00	•	•	
Zip 4 00	•	•	•
Zip & Zip Bimod. 94-97	•	•	
PIAGGIO 80:			
Skr City 99	•	•	
PIAGGIO 125:			
Hexagon Lx4 98-99	•	•	•
Liberty 98-00	•	•	•
Vespa Et4 96-99	•	•	•
Sfera 95-97 (R.o. 289519)	•	•	•

12 185 0280 

Dado M12x1,25 - Nut

Confezione 10 pz. - 10 Pcs Packing



DADO M 10 X 1,25 - NUT	PULEGGIA CONDOTTA DRIVEN PULLEY	MOTRICE DRIVING PULLEY	VOLANO FLYWHEEL
Dna 125-180		•	•
Runner Fx-Fxr 125-180	•	•	•
GILERA:			
Runner Vx-Vxr 125-180		•	•
Typhoon 125 95-98	•	•	•
Typhoon 125 95-98	•	•	•
Hexagon Lx-Lxt 125-180	•	•	•
Hexagon 125-180 94-97	•	•	•
Liberty 125-150 00/01		•	•
Super Hexagon Gtx125-180		•	•
PIAGGIO:			
Skipper 4T 125-150- 200 01		•	•
Skipper 125-150 98-99	•	•	•
Skipper Lx 125-150 98-99	•	•	•
Vespa Et4 125-150 99-01		•	•
X9 Amalfi 180 00/01		•	•
Zip 125 00		•	•
(r.o.436783)			

18 420 0020 

Dado superiore sterzo passante

Steering upper nut

PIAGGIO: Si • Bravo P • Bravo 3

(R.O. 184431)





DADI - RONDELLE NUTS - WASHERS

12 185 0470



DADO FRIZIONE - CLUTCH NUT

Confezione 10 pz. - 10 Pcs Packing

MBK 125: Xc Flame F 00 • Xc X Flame R 95-99 • Xc T Flame 95-99 • Xn Doodo 00-01 • Yp Skyliner 98-02

150: Xc Vertex 97 • Yp Skyliner 00-02

250: Yp Skyliner Abs 03 • Yp Skyliner 00-03

300: Xc Kilibre 03

YAMAHA 125: Nxc Cygnus X 04-11 • Xc Beluga 90-95 • Xc Cygnus R 99-03 • Xc K Cygnus R 97-98 • Xc T Cygnus 95-98 • Xn Teo's 00 • Yp Majesty 98-02 • Yw Bw's 10

150: Xc Fly One R 97-98 • Xc Fly One 90-95 • Yp Majesty 00-02

250: Vp X-City 07-12 • Yp Majesty Abs 03 • Yp majesty Dx 98-99 • Yp Majesty 95-03 • Yp R Black X-Max 09 • Yp R X-Max Abs 11-12 • Yp R X-Max Sport 11-12 • Yp R X-Max 05-12

300: Xc Versity 03-06

400: Yp Majesty Abs 07-11 • Yp Majesty 04-11

500: Xp T-Max Abs Sv 11 • Xp T-Max Abs 05-11 • Xp T-Max Black Max - Night Max 07 • T Max Black Max 06 • Xp T-Max Sv 11 • Xp T-Max White Max 10 • Xp T-Max 01-11

530: Xp T-Max Abs 12 • Xp T-Max 12

(R.O. 901703627900)



12 185 8570



BALESTRINO FRIZIONE

CLUTCH PUSH RING

PIAGGIO 50: Ciao • Si

(R.O. 220441)



12 185 8520



RONDELLA DI FERMO - WASHER - RONDELLE

PIAGGIO 125-150-200: Vespa Px • Pxe Arcobaleno

VNX-VLX-VSX-VNX2-VLX2-VSX2

(R.O. 016305)



12 185 8500



PIASTRINA ELASTICA - PLATE FIXING PRING

PIAGGIO 125-150-200: Vespa Px • Pxe Arcobaleno

VNX-VLX-VSX-VNX2-VLX2-VSX2

(R.O. 181475)



12 185 8510



RONDELLA - WASHER

PIAGGIO 125-150-200: Vespa Px • Pxe Arcobaleno

VNX-VLX-VSX-VNX2-VLX2-VSX2

(R.O. 139890)



12 185 8580



DISTANZIALE PERNO RUOTA - PIN SPACER

PIAGGIO 150: Vespa GL • Sprint-Rally

(R.O. 99474)



12 185 8530



RONDELLA DI SPALLAMENTO

CRANK SHAFT WASHER

PIAGGIO 50: Ciao • Si - (R.O. 102943)

12 185 8540



RONDELLA MOZZO POSTERIORE

HUB WASHER

PIAGGIO 50: Ciao • Si

(R.O. 131514)

12 185 8550



RONDELLA PULEGGIA POSTERIORE

REAR PULLEY WASHER

PIAGGIO 50: Ciao • Si - (R.O. 103556)

12 185 8560



RONDELLA PULEGGIA- PULLEY WASHER

PIAGGIO 50: Ciao • Si

(R.O. 103557)



12 185 6100
**VITE TESTA CON INSERTO A CROCE
PER CARROZZERIA - BODYWORK SCREW**

Confezione 10 pz. - 10 Pcs Packing

GILERA: Typhoon 50 • Stalker • Storm

Runner 50-125-180 • Vx • Vxr 125-180

Dna 50-125-180

PIAGGIO: Sfera 50-125 • Et2 • Et4

Skipper 4t • Super Hexagon Gt

Hexagon Lx4

Hexagon Lx

Lxt • Liberty

50-125-150

Zip 50-125

Zip 4 • Nrg • Mc2

Mc3-X9 180-500

Ape 50 Rst Mix

(R.O. 298086-575249)

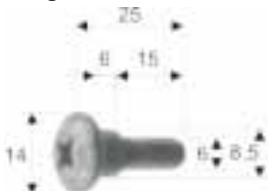
12 185 8640
VITE PER LEVA - SCREW WITH NUT

Vari Modelli Vespa - Various Vespa Models

(R.O. 6610283M)

12 185 6120
VITE LEVA FRENO E FRIZIONE
LEVERS SECURING SCREW

Confezione 50 pz. - 50 Pcs Packing

PIAGGIO: Vespa 50-90-125

Primavera Et3 • Px • Pe

(R.O. 150235-012136)

12 185 0480
VITE FISSAGGIO RUOTA - WHEEL FIXING BOLT
PIAGGIO: Vespa 50-90 V5SA1-V9A1

(R.O. 070156)

12 185 8450
**VITE + DADO MANUBRIO
HANDLE BAR SCREW + NUT**

Confezione 5 pz. - 5 Pcs Packing

PIAGGIO: Vespa

(R.O. 0015542-070620)

12 185 0370
**VITE PARAFANGO
SCREW MUDGUARD**

Tutti i modelli Vespa - Vespa All models

(R.O. 014467)

12 185 8630
**BULLONE AMMORTIZZATORE POSTERIORE
BOLT**

Tutti i modelli Vespa - Vespa All models

(R.O. 014689)

12 185 8900
VITE PER MARMITTA - BOLT MUFFLER
PIAGGIO 125-150-200: Vespa Px

(R.O. 014691)

12 185 8490
BULLONE RUOTA DI SCORTA - BOLT
PIAGGIO 125-150-200: Vespa Px- Vespa

125-T5

(R.O. 159873)

12 186 0270
KIT PRIGIONIERO TAMBURO - DRUM KIT STUD
PIAGGIO: Vespa Px 125-150-200

• Vespa GL Sprint 150





DADI - RONDELLE
NUTS - WASHERS

PRIGIONIERI BULLONI - STUDS BOLTS

12 185 6000

PRIGIONIERO SCARICO Ø 6 X 33
STUD FOR SECURING EXHAUST PIPE

Confezione 50 pz. - 50 Pcs Packing
PIAGGIO: Vespa 50 tutte • Ape P50
(R.O. 003918)

PEUGEOT: Buxy • Speedake • SV Geo-Squab • Speedfight • Trekker

12 185 6030

PRIGIONIERO CILINDRO Ø 7 X 109
CYLINDER SECURING STUD

Confezione 20 pz. - 20 Pcs Packing
MINARELLI-YAMAHA: Scooter 50
(cilindro orizzontale) raffr. aria-acqua
(R.O. 7491880-901160735300)

12 185 8740

PRIGIONIERO CARTER 7X52 - STUD

PIAGGIO: Vespa Px-GL-Sprint
(R.O. 239153)

12 185 6010

PRIGIONIERO SCARICO Ø 6 X 26
EXHAUST PIPE STUD

Confezione 50 pz. - 50 Pcs Packing
PIAGGIO: Scooter 50-125-180-500
(R.O. 239397)

12 185 6040

PRIGIONIERO CILINDRO Ø 7 X 142
CYLINDER SECURING STUD

Confezione 20 pz. - 20 Pcs Packing
PIAGGIO: Vespa 125-Et3 - (R.O. 150656)

12 186 0250

PRIGIONIERO FLANGIA TAMBURO POST.
REAR DRUM FLANGE STUD

Vespa 50-90-125 Primavera ET3 - PK 50-125
Confezione 10 pz. - 10 Pcs Packing
(R.O. 000456)

12 185 6020

PRIGIONIERO CILINDRO Ø 6 X 106
CYLINDER SECURING STUD

Confezione 20 pz. - 20 Pcs Packing
GILERA-PIAGGIO: Scooter 50
raffr. aria-acqua
(R.O. 239382)

MBK: cilindro verticale
(R.O. 901160641800)

12 185 6130

PRIGIONIERO CILINDRO Ø 8 X 160
CYLINDER SECURING STUD

PIAGGIO: Vespa 200 • Cosa • Ape
Confezione 20 pz. - 20 Pcs Packing
(R.O. 016058)

12 186 0260

PRIGIONIERO BASE CILINDRO
CYLINDER STUD

Vespa 50-90-125 Primavera ET3 - PK 50-125
Confezione 10 pz. - 10 Pcs Packing
(R.O. 004515)



VITI CARTER MOTORE - CRANCKCASE SCREWS



M7 X L	MODELLI - MODELS	R.O.	CODICE - CODE	BARCODE
M7 x 45 mm	Vespa 50 - 90 - 125 Primavera ET3	008420	12 185 8660	
M7 x 50 mm	Vespa PX 125 - 150 - 200	239149	12 185 8690	
M7 x 54 mm	Vespa 50 - 90 - 125 Primavera ET3	008421	12 185 8670	
M7 x 65 mm	Vespa 50 - 90 - 125 Primavera ET3	008499	12 185 8650	
M7 x 80 mm	Vespa 50 - 90 - 125 Primavera ET3	008419	12 185 8680	
M7 x 90 mm	50: Ape FL-FL2-FL3 • Ape P • Ape Tm 220: Ape Car P2-P3 • Ape Tm P 703	015647	12 185 8760	
M7 x 95 mm	Vespa PX 125 - 150 - 200	239150	12 185 8700	

KIT BULLONI CARTER MOTORE
CRANCKCASE BOLTS KIT



MODELLI - MODELS	CODICE - CODE	BARCODE
Vespa 50 - 90 - 125 Primavera ET3	12 186 0120	
Vespa PX 125 - 150	12 186 0130	
Vespa PE 200	12 186 0140	



12 186 0110



KIT BULLONE MOTORE
ENGINE BOLT KIT

PIAGGIO 50-90-125: Vespa Primavera ET3 - PK 50-125



12 186 0353



KIT BULLONE MOTORE
ENGINE KIT BOLT

PIAGGIO 125-150-200: Vespa Sprint • GL
• Super
VNX - VLX - VSX - VLA - VLB - VBC



12 186 0363



KIT TUBO MOTORE COMPLETO
ENGINE TUBE KIT

PIAGGIO 125-150-200: Vespa Sprint • GL
• Super
VNX - VLX - VSX - VLA - VLB - VBC



12 186 0333



BULLONE CARBURATORE
CARBURATOR BOLT

PIAGGIO 125-150-200: Vespa VNX - VLX - VSX
(R.O. 049542)



12 185 8430



CHIAVETTA VOLANO - FLYWHEEL KEY

12,6 x 5 x 3 (mm)

PIAGGIO: Vespa
(R.O. 000267)



12 185 8440



CHIAVETTA FRIZIONE - CLUTCH KEY

6,45 x 15,3 x 4 (mm)

PIAGGIO: Vespa
(R.O. 000097)





DADI - RONDELLE NUTS - WASHERS



CODICE RMS RMS CODE	DIMENSIONI DIMENSIONS	QUANTITÀ QUANTITY	BARCODE
DADO ZINCATO - GALVANIZED NUT			
12 185 8840	M 4	100 Pz.	
12 185 8850	M 5	100 Pz.	
12 185 8860	M 6	100 Pz.	
12 185 8870	M 7	100 Pz.	
12 185 8880	M 8	100 Pz.	



CODICE RMS RMS CODE	DIMENSIONI DIMENSIONS	QUANTITÀ QUANTITY	BARCODE
RONDELLA PIANA ZINCATA - GALVANIZED WASHER			
12 185 8810	Ø 5	100 Pz.	
12 185 8820	Ø 6	100 Pz.	
12 185 8720	Ø 7	100 Pz.	
12 185 8830	Ø 8	100 Pz.	



CODICE RMS RMS CODE	DIMENSIONI DIMENSIONS	QUANTITÀ QUANTITY	BARCODE
RONDELLA GROWER ZINCATA - GROWER GALVANIZED WASHER			
12 185 8790	Ø 5	100 Pz.	
12 185 8800	Ø 6	100 Pz.	
12 185 8730	Ø 7	100 Pz.	
12 185 8780	Ø 8	100 Pz.	
12 186 0060	Ø 9	100 Pz.	
12 186 0070	Ø 10	100 Pz.	



CODICE RMS RMS CODE	DIMENSIONI DIMENSIONS	QUANTITÀ QUANTITY	BARCODE
VITE TESTA TAGLIO ZINCATA - GALVANIZED SCREW			
12 185 8890	M6 x 12	25 Pz.	
Per copri ventola Vespa - For Vespa fan cover			



CODICE RMS RMS CODE	DIMENSIONI DIMENSIONS	QUANTITÀ QUANTITY	BARCODE
VITE TESTA PHILIPS ZINCATA - PHILIPS GALVANIZED SCREW			
12 185 8610	M5 x 35	25 Pz.	
Per copri manubrio Vespa Px - For Vespa Px handle bar			



CODICE RMS RMS CODE	DIMENSIONI DIMENSIONS	QUANTITÀ QUANTITY	BARCODE
VITE TESTA ESAGONALE ZINCATA - GALVANIZED HEXAGONAL SCREW			
12 185 8910	M 5 X 16	100 Pz.	
12 185 8920	M 5 X 20	100 Pz.	
12 185 8930	M 5 X 25	100 Pz.	
12 185 8940	M 6 X 16	100 Pz.	
12 185 8950	M 6 X 20	100 Pz.	
12 185 8960	M 6 X 25	100 Pz.	
12 186 0080	M 7 X 16	100 Pz.	
12 186 0090	M 7 X 20	100 Pz.	
12 186 0100	M 7 X 25	100 Pz.	
12 185 8970	M 8 X 16	100 Pz.	
12 185 8980	M 8 X 20	100 Pz.	
12 185 8990	M 8 X 25	100 Pz.	
12 185 8900	M 10 X 80	100 Pz.	



12 185 9030 

FASCETTA BANDA PIENA - CLAMP Ø 15-25 mm
Confezione 10 pz. - 10 Pcs Packing

12 185 9050 

FASCETTA BANDA PIENA - CLAMP Ø 32-50 mm
Confezione 10 pz. - 10 Pcs Packing

12 185 9040 

FASCETTA BANDA PIENA - CLAMP Ø 20-32 mm
Confezione 10 pz. - 10 Pcs Packing

12 185 9060 

FASCETTA BANDA PIENA - CLAMP Ø 50-70 mm
Confezione 10 pz. - 10 Pcs Packing



12 185 9000 

COLLARE TUBO BENZINA
FUEL CLAMP Ø 20 mm
Confezione 10 pz. - 10 Pcs Packing

12 185 9020 

COLLARE TUBO BENZINA
FUEL CLAMP Ø 12-14 mm
Confezione 10 pz. - 10 Pcs Packing



12 185 9010 

COLLARE TUBO BENZINA
FUEL CLAMP Ø 10-12 mm
Confezione 10 pz. - 10 Pcs Packing

12 185 9070 

PASSACAVO GOMMATO - GROMMET Ø 8 mm
Confezione 10 pz. - 10 Pcs Packing

12 185 9090 

PASSACAVO GOMMATO - GROMMET Ø 16 mm
Confezione 10 pz. - 10 Pcs Packing



12 185 9080 

PASSACAVO GOMMATO - GROMMET Ø 12 mm
Confezione 10 pz. - 10 Pcs Packing

12 186 0023 

PIASTRINA FERMA GUAINA - CABLE PLATE
PIAGGIO 125-150-200: Vespa Px • Pxe
Arcobaleno
VNX-VLX-VSX-VNX2-VLX2-VSX2
(R.O. 0823854)

12 186 0033 

LEVA FRENO - BRAKE LEVER
PIAGGIO 125-150-200: Vespa Px • Pxe
Arcobaleno
VNX-VLX-VSX-VNX2-VLX2-VSX2
(R.O. 1011014)





FASCETTE CLAMPS

12 186 0200

**PIASTRINA PER VITE AUTOFILETTANTE Ø 2,9
SELF THREADING PLATE Ø 2,9**

Per fissaggio Clacson Vespa 50 N-L-R
Primavera 125: GL-Super 125-150 Ss 180 Gt •
125 Sprint 150 rally 180-200-T5 125
Confezione 100 pz. - 100 Pcs Packing



12 186 0210

**PIASTRINA PER VITE AUTOFILETTANTE Ø 3,5
SELF THREADING PLATE Ø 3,5**

Per fissaggio bordo scudo inferiore Vespa Lx-Lx
FL 2T-4T 50-125-150 - Vespa S 2T-4T 50-125-150
Applicazioni varie - *Various applications:*
Beverly-Fly-Free-Liberty-Nrg-Skipper-X9-Zip-
Porter
Confezione 100 pz. - 100 Pcs Packing



12 186 0220

**PIASTRINA PER VITE AUTOFILETTANTE Ø 4,2
SELF THREADING PLATE Ø 4,2**

Applicazioni varie - *Various applications:*
Beverly-Carnaby-Fly-Free-Hexagon-Liberty
-Mp3-Nrg-Sfera-Skipper-Vespa Et2-Et4-Grantu-
rismo-Gts-Gtv-Lx-Vespa S 2T-4T-X Evo-X7-X8-
X9-Zip-Typhoon-Ape Calessino -Car-MP601-
Poker Benzina/Diesel
Confezione 100 pz. - 100 Pcs Packing



12 186 0230

**PIASTRINA BRUNITA PER VITE
AUTOFILETTANTE Ø 4,2
SELF THREADING PLATE Ø 4,2**

Applicazioni varie - *Various applications:*
Beverly-Carnaby-Fly-Liberty-Mp3-Nrg-Vespa
Granturismo Gts-Vespa Lx-Vespa S 2T/4T-X Evo-
X7-X8-X9 Evolution-Zip 2T/4T-Ape Tm D Lcs
Confezione 100 pz. - 100 Pcs Packing



12 186 0240

PIASTRINA PER VITE Ø 6 - PLATE Ø 6

Applicazioni varie - *Various applications:*
Beverly-Carnaby-Diesis-Fly-Free-Hexagon-
Liberty-Mp3-Nrg-Ntt-Sfera-Skipper-Skr-Vespa-
Granturismo-Lx-Lxv-Vespa S 2T/4T-X-Evo-X7-
X8-X9-Zip-Ape Rst Mix-Poker Benzina-Tm D
Lcs-Porter
Confezione 100 pz. - 100 Pcs Packing





12 167 0020 

GILERA		
Easy Moving	50	95-96
Ice	50	01
Stalker	50	97-01
Storm	50	94-95
Typhoon - Typhoon X	50	98-99
Typhoon Xr	50	00
Typhoon	125	95-98
Typhoon X-Xr	125	99-00

MALAGUTI		
Crosser Cr1	50	95-98
Yesterday - Yesterday EU	50	97-00
F10 Jet Line-Kat-Restyling	50	92-02
F10 Restyling EU 2-2.3	50	02-03
F12 Phantom Lc Twin Disks	50	98
F12 Phantom-Phantom Lc	50	94-98
F12 Phantom EU 1 - Lc	50	99-00
F12 Phantom Restyling-Lc	50	01-02
F12 Phantom Rest. EU 2-Lc	50	02
F12 Phantom Rest. EU 2-2,3	50	03
F12 Phant. Lc Res. EU 2-2.3	50	03
F15 Fire Fox - Fire Fox EU 2	50	96-03
F15 Fire Fox T. D. & Special	50	98-99
F15 Fire Fox T. D. Digit Kat	50	98-00
F15 Lc-Tds Restyling EU 1	50	01
F12 Phantom - (R.O. 09304500)	100	99-00

MBK		
Nitro	50	97-98
Ovetto R - R Eu1- Eu2	50	97-03

PIAGGIO		
Free - Free Delivery - FL	50	00-01
Liberty	50	97-02
Nrg Rst Mc2 - Ntt	50	96-98
Nrg Extreme - Mc3	50	99-02
Vespa Et2 - Et2 iniezione	50	97-01
Sfera Rst	50	95-97
Sfera base	50	91-93
Sfera Maquillage 2	50	94
Quartz	50	92-96
Typhoon	50	01
Zip & Zip Bimodale	50	94-97
Zip Base - Rst - Sp	50	92-00
Zip Fast Raider - Rst	50	93-97
Skr City	80	99
Vespa Et4	125	96-99
Liberty	125	98-00
Sfera	125	95-97
Skipper - Skipper Lx - (R.O. 575331)	125-150	94-99

YAMAHA		
Aerox	50	97-98
Neo's R - Neo's EU 2 - (R.O. 5ADF4500000)	50	97-03



12 167 0240 

MALAGUTI		
Madison	125	99-01
Madison T	150	99-01
Madison Restyling - (R.O. 09305900)	125	02

MBK		
Skyliner	125	98-00
Skyliner	150	00

YAMAHA		
Majesty	125	98-00
Majesty - (R.O. 5DSF450000)	150	00



12 167 0260 

HONDA		
Sh		50

BAOTIAN-SCOOTER CINESI		
Serbatoio in metallo		50



12 167 0220 

GILERA		
Dna	50	00-01
Runner	50	97-00
Dna	125-180	01
Runner vx-Vxr	125-180-200	00-02

PIAGGIO		
Free - (R.O. 577881)	100	02



12 167 0270 

HONDA		
Sh		125-150



12 167 0250 

MBK 50:		
Cw Booster		90-04
Cwr Booster Road		94-95
Ye Evolis		92-95
Ym Fizz		94-95
Cw Booster Spirit		96-00
CWL Booster		01-03
Cw Sp Booster Spirit Eu2		02
Cw Booster Spirit Eu2		02-03
CWL Booster Spirit		03
CW Booster Naked		03

YAMAHA 50:		
Ym Breeze		94-95
Bw's Original		97-02
Bw's R		01
Cw Sp Bw's Original Eu2		02
Cw Bw's Original Eu2		02-03
CWL Bw's		03
Bw's Naked		03





RUBINETTI BENZINA

FUEL COCKS

12 167 0230



PIAGGIO:		
Liberty 4T	50	00-02
Vespa Et2	50	97-01
Vespa Et4	50	00-02
Zip - Zip Sp	50	01-02
Zip 4	50	00
Liberty	125	98-00
Liberty	125-150	00-02
Vespa Et4	125-150	99-02
Skipper 4T	125-150	00/-02
Vespa Granturismo	125-200	03
Zip - (R.O. 575321)	125	00
Boulevard	125	02-04
Boulevard Eu2	125	04-07
Boulevard 2T	50	09-14
Boulevard 4T	100	10-11
Boulevard 4T E3	150	10
Boulevard 4T Eu2 25 K/h	50	09
Boulevard 4T Eu3	125	08-12
Boulevard Eu2	200	05-06
Gp1 Eu2	50	05
Gp1 Race Eu2	50	05-07
Sonar 2T	50	09
Sonar 4T	125	09-11
Sonar 4T	150	09
Variant Sport 2T	50	12
Variant Sport 4T E3	125	12

12 167 0090



PIAGGIO:		
Ciao - Sc - Px - FL - Teen - (R.O. 143559)	50	



12 171 0010



SONDA RISERVA - FUEL SENSOR		
GILERA:		
Easy Moving	50	95-96
PIAGGIO:		
Zip & Zip Bimodale	50	94-97
Zip Base	50	92-96
Zip Rst	50	96-99
Zip Fast Raider Rst	50	96-97
Zip fast Raider	50	93-94
Zip Sp - (R.O. 259346)	50	96-00



12 167 0170



PIAGGIO: (Senza Riserva - Without reserve)		
Vespa Pxe Arcobaleno	125-150-200	81-97
Vespa Px T5	125	85-89
Vespa Px - (R.O. 217872)	125-150-200	98-01

12 167 0150



PIAGGIO:		
Vespa Et3 - (R.O. 139938)	50-125	

12 167 0050



PIAGGIO: (Con Riserva - With reserve)		
Vespa Px	125-150-200	77>
(R.O. 158793)		



12 167 0180



PIAGGIO:		
Ape P	50	80-85
Tm P - (R.O. 118092)	50	85-89

12 167 0190



PIAGGIO:		
Ape FL - FL2	50	89-95
Ape Rst Mix	50	99-03
Ape FL3 Europa	50	96-99
Ape Tm P602	220	82-83
Ape Tm P703/P703V/FL2 - (R.O. 189320)	220	84-01

12 167 0200



PIAGGIO:		
Ape MP P501 / P601 - (R.O. 118422)	220	78-96





12 167 0080 

PIAGGIO:

Si - Si FL2 - Si Mix - (R.O. 254724) 50 79-99



12 167 0010 

STANDARD:

Ciclomotore / Moped Ø 10 x 1



12 166 0020 

GILERA:

Runner Vx-Vxr 125-180-200 00-02

PIAGGIO:

Super Hexagon Gtx 125-180 00

Super Hexagon Gtx 12" 125-180 01

Beverly 125-200 01-02

X9 125-200 01-03

X9 Amalfi - (R.O. 827894) 180 00-03



12 167 8010 

GILERA:

Eaglet - Eaglet automatico 50 96-97

Ice 50 01

Easy Moving 50 95-96

Stalker - Storm - Dna 50 97-01

Runner - FL - Purejet - Poggiali 50 97-02

Typhoon X - Xr 50 98-00

Typhoon-Typhoon Xr 50-125 94-00

Runner Fx-Fxr 125-180 97-02

PIAGGIO:

Ape Rst Mix 50 99-03

Free - Free Delivery - FL 50 92-01

Liberty 50 97-02

Nrg Purejet - Extreme 50 99-02

Ntt - Nrg - Nrg Mc3 50 94-02

Nrg Rst Mc2 50 96-98

Puch P1-Tre 50 93-98

Sfera Maquillage 2 - Base - Rst 50 91-97

Vespa Et2 - Et2 Iniezione 50 97-01

Vespa FL2 Automatica 50 90-91

Vespa Pk XL Plurimatic 50 85-90

Velofax 50 96-99

Quartz 50 92-96

Typhoon 50 01

Zip fast Raider Rst - Rst 50 93-99

Zip & Zip Bimodale - Base - Sp 50 94-97

Skr City 80 99

Hexagon Lx4 125 98-99

Vespa Pk S Automatica 50-125 84-89

Cosa 2 - Cosa CL-CLX 125-150-200 88-97

Skipper - Skipper Lx 125-150 94-99

(R.O. 574362)



12 166 0010 

BETA:

Tempo 50 94-99

Quadra - Chrono 502 50 95-99

GILERA:

Runner - Runner FL 50 97-02

Runner Poggiali 50 02

Typhoon - Typhoon X-Xr 125 95-00

Runner Fx-Fxr - (R.O. 82592R) 125-150 97-02

MALAGUTI:

Ciak - Ciak Td 50 99-01

Ciak EU 2-2.3 - Ciak EU 2 - (R.O. 09305700) 50 03

PIAGGIO:

Hexagon - (R.O. 82592R) 125-150 94-97



12 167 8023 

Vespa Old Model
Con vaschetta in alluminio
With aluminium bowl

12 167 8033 

Vespa Old Model
Con vaschetta in vetro
With glass bowl



ASTA RUBINETTO - FUEL TAP LEVER

12 168 0020 

ASTA RUBINETTO - FUEL TAP LEVER

PIAGGIO: Px Pe-Px Pe Arcobaleno
Lunghezza 175 mm. - *Lenght 175 mm.*
(R.O. 103202)

12 168 0040 

ASTA RUBINETTO - FUEL TAP LEVER

PIAGGIO: Vespa 50-90-125 Primavera Et3
Lunghezza 200 mm. - *Lenght 200 mm.*
(R.O. 098514)





TUBI BENZINA E ACCESSORI FUEL HOSES AND ACCESSORIES

TUBO PER BENZINA - FUEL HOSE

PVC PLASTIFICATO • 63ShA - PLASTIFIED PVC • 63ShA



12 169 0010 

Miscelatore - Ø 2,2 x 4 - mt. 5
Mixer oil hose

12 169 0080 

Miscelatore Ø 2,5 x 5 - mt. 5
Mixer oil hose

12 169 0020 

Scarico residui benzina - Ø 3 x 5 - mt. 5
Fuel surplus hose

12 169 0030 

Ciclomotore - Ø 4 x 7 - mt. 5 - Moped

12 169 0039 

Ciclomotore - Ø 4 x 7 - mt. 50 - Moped

12 169 0040 

Scooter - Ø 5 x 10 - mt. 5 - Scooter

12 169 0049 

Scooter - Ø 5 x 10 - mt. 50 - Scooter

12 169 0050 

Moto - Ø 6 x 9 - mt. 5 - Motorbike

12 169 0059 

Moto - Ø 6 x 9 - mt. 50 - Motorbike

12 169 0060 

Vespa e auto - Ø 7 x 12 - mt. 5 - Vespa and car

12 169 0069 

Vespa e auto - Ø 7 x 12 - mt. 50 - Vespa and car

12 169 0070 

Scooter Piaggio - Ø 7 x 14 - mt. 5
Scooter Piaggio

12 169 0090 

Ø 5 x 7 - mt. 5

TUBO PER BENZINA VERDE - UNLEADED FUEL HOSE

PVC + 30% PU • 65ShA • SPECIFICO PER BENZINA VERDE ED OLIO - SPECIFIC FOR UNLEADED FUEL AND OIL



12 169 0031 

Ciclomotore - Ø 4 x 7 - mt. 5 - Moped

12 169 0041 

Scooter - Ø 5 x 10 - mt. 5

12 169 0051 

Moto - Ø 6 x 9 - mt. 5 - Motorbike

12 169 0061 

Vespa e auto - Ø 7 x 12 - mt. 5 - Vespa and car

12 169 0071 

Scooter Piaggio - Ø 7 x 14 - mt. 5

12 169 0091 

Ø 5 x 7 - mt. 5

MISURINI CENTILITRATI - DOSAGE BEAKERS

14 274 0010 

Misurino centilitrato da 10 cl.
Oil dosage beaker 2% - 10 cl.
(R.O. 085058)



14 274 0020 

Misurino centilitrato da 10 cl.
Doppia centilitratura 2/4%
Dosage beaker 2/4% 10 cl.
(Con coperchio)



12 168 0060 

Raccordo rapido tubo benzina 6 mm
6 mm fuel hose quick connector

12 168 0070 

Raccordo rapido tubo benzina 8 mm
8 mm fuel hose quick connector





12 166 0030 

SUZUKI 250: Burgman 03>
400: Burgman 03-06
Pressione di esercizio 3 Bar - Working pressure 3 Bar
Portata 100 l/h - Flow 100 l/h

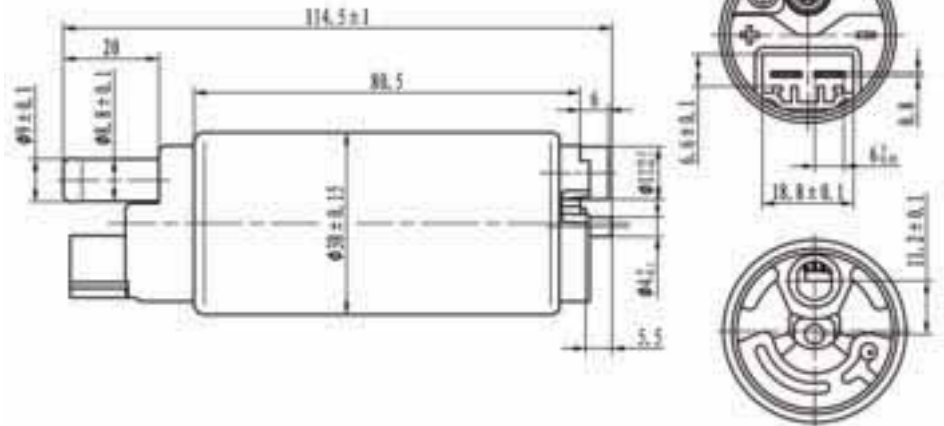

12 166 0040 

SUZUKI 125-200: Burgman 07-12
125-150: Sixteen 08>
YAMAHA 125: X Max 08>
250: X Max 07>
400: Majesty 04>
500: T Max 04-11
530: T Max 12>
Pressione di esercizio 3 Bar - Working pressure 3 Bar
Portata 35 l/h - Flow 35 l/h

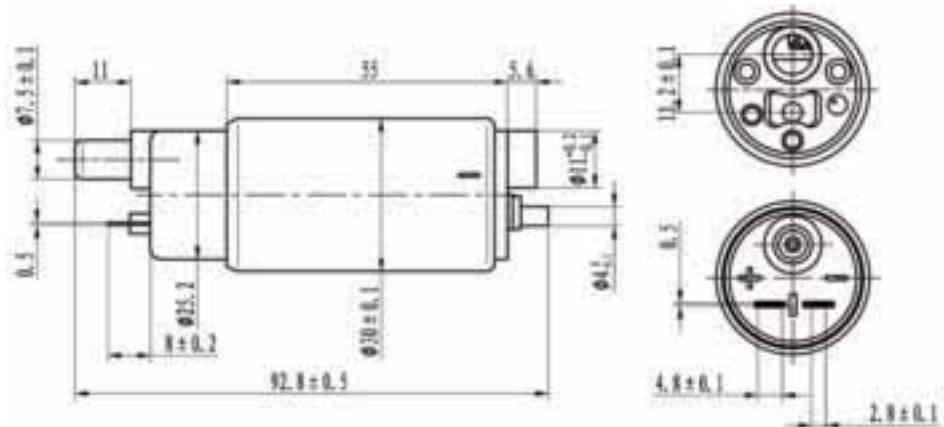

12 166 0050 

APRILIA 400-500: Scarabeo Light 06-08
PIAGGIO 500: Beverly 02>
Pressione di esercizio 3 Bar - Working pressure 3 Bar
Portata 100 l/h - Flow 100 l/h

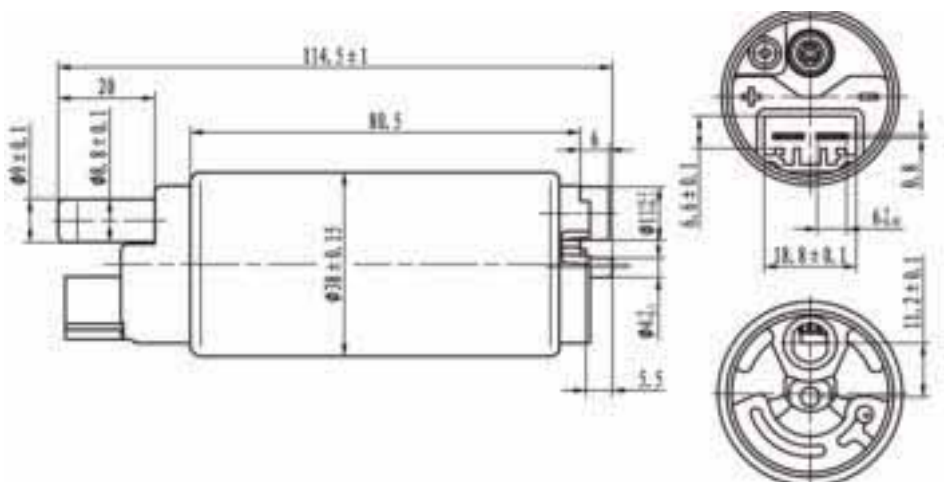



POMPE BENZINA
FUEL PUMPS

12 166 0060 

PIAGGIO 300: Vespa Gts ie Touring 11-12
Vespa Gts ie 12-14 • Vespa Gts Super Sport 10-13
Vespa Gtv 4T 4V ie 10-13 • Vespa Gtv Via
Montenapoleone 10

Senza cablaggi - No wires

Pressione di esercizio 3 Bar - Working pressure 3 Bar

Portata 35 l/h - Flow 35 l/h

(R.O. 640516)

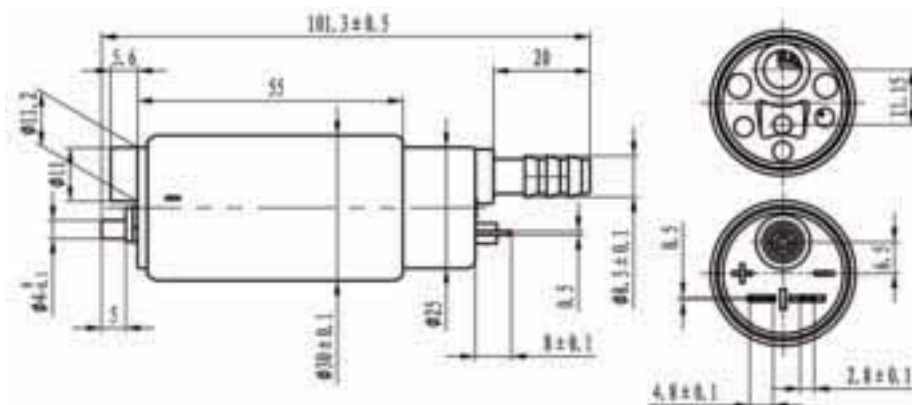

12 166 0070 

SUZUKI 400: Burgman 07>

Pressione di esercizio 3 Bar - Working pressure 3 Bar

Portata 60 l/h - Flow 60 l/h

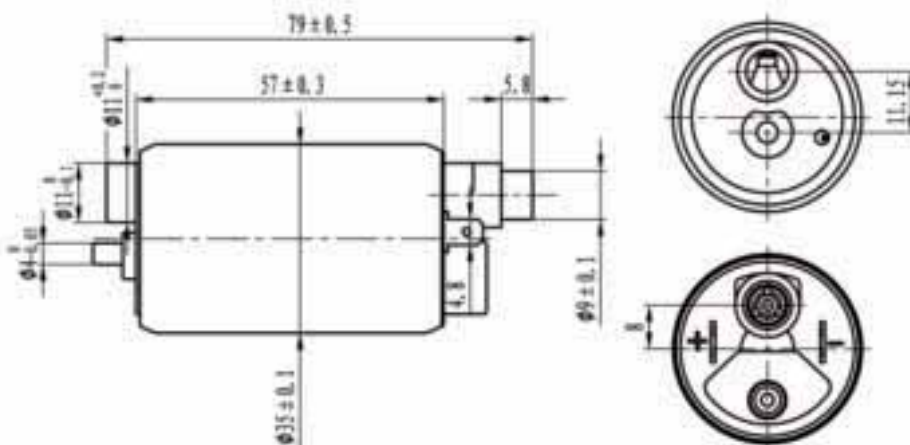

12 166 0080 

HONDA 125-150-300: Sh 05>

Pressione di esercizio 3 Bar - Working pressure 3 Bar

Portata 35 l/h - Flow 35 l/h

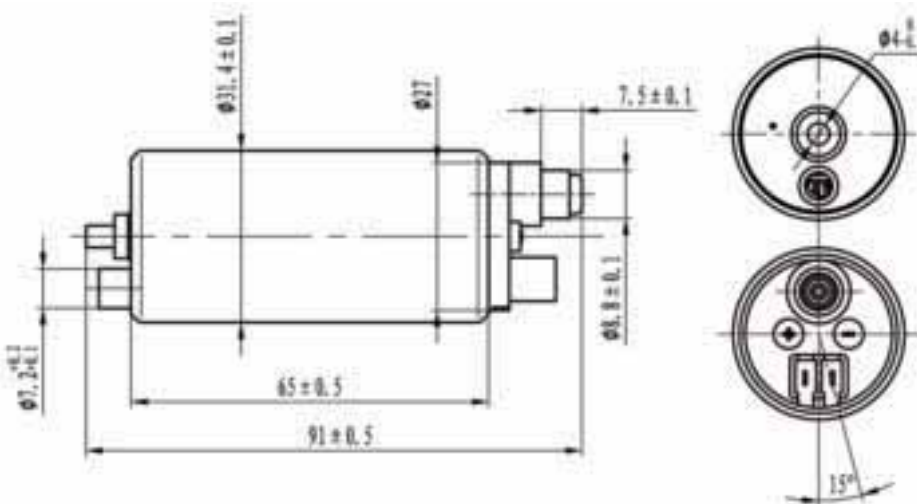



12 165 0010



TAPPO SERBATOIO BENZINA - FUEL CAP

MBK: Nitro 50 97-02
YAMAHA: Aerox 50 97-02



12 165 0030



**TAPPO SERBATOIO BENZINA
(CON GUARNIZIONE)
FUEL CAP (WITH GASKET)
PIAGGIO:** Ciao P • Px
(R.O. 182356)



12 165 0042



**TAPPO SERBATOIO - FUEL CAP
PIAGGIO 50:** Vespa FL • N • Pk
125-150-200: Vespa Px • T5
(R.O. 575825)



12 165 0053



**TAPPO OLIO MISCELATORE
OIL TANK CAP**

PIAGGIO 125-150-200:
Vespa Px Arcobaleno-T5
(R.O. 102585)



12 165 0063



**KIT TAPPO SERBATOIO
KIT TANK CAP**



12 186 0010



TAPPO OLIO - OIL PLUG

Vari Modelli Vespa - *Various Vespa Models*
(R.O. 030280)



12 185 6140



TAPPO OLIO - OIL FILLER CAP

HONDA 150: Sh
(R.O. 12361-KGF-305)
Conf. 5 pz. - 5/Pcs Packing



12 185 6070



**TAPPO SCARICO OLIO MOTORE
ENGINE OIL CUP**

Conf. 20 pz. - 20/Pcs Packing
PIAGGIO-GILERA:
Scooter 50-125-150 • Typhoon
Hexagon Lx4 • Sfera-Liberty
Et4 • Skipper • Hexagon
Vespa 50-125-150-200
Ape 50
(R.O. 138345)

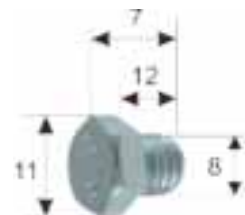



CONTACHILOMETRI
SPEEDOMETER

16 368 0003



CONTACHILOMETRI - SPEEDOMETER
PIAGGIO: Vespa 50
(R.O. 190748)



16 368 0013



CONTACHILOMETRI - SPEEDOMETER
PIAGGIO: Vespa 50 Special
(R.O. 123474)



16 368 0023



CONTACHILOMETRI - SPEEDOMETER
Vespa 125
VNA-VNB
Scala 90 Km/h
(R.O. 083205)



16 368 0033



CONTACHILOMETRI - SPEEDOMETER
Vespa 125 Struzzo
Scala 100 Km/h
Grigio - Grey



16 368 0053



CONTACHILOMETRI - SPEEDOMETER
Vespa 125-150
Scala 100 Km/h
Verde - Green
(R.O. 015019)



16 368 0063



CONTACHILOMETRI - SPEEDOMETER
Vespa 125
Scala 90 Km/h
Nero - Black



16 368 0073



CONTACHILOMETRI - SPEEDOMETER
Vespa 125 Primavera
VMA2T
Scala 120 Km/h
(R.O. 121051)





16 368 0303 



**TRASPARENTE CONTACHILOMETRI
SPEEDOMETER TRANSPARENT**

Vespa 125-150
V30t-V33t-Vm1/2T
Vn1/2T-Vl1/2/3T
(R.O. 017713)



16 368 0313 



**TRASPARENTE CONTACHILOMETRI
SPEEDOMETER TRANSPARENT**

Vespa 150 VB1T
Vespa 150 Gs VS1/2/3/4T
(R.O. 024818)



16 368 0323 



**TRASPARENTE CONTACHILOMETRI
SPEEDOMETER TRANSPARENT**

Vespa 125
VNA1/2T-VNB1/2/3/4/5/6T
(R.O. 083202)



16 368 0333 



**TRASPARENTE CONTACHILOMETRI
SPEEDOMETER TRANSPARENT**

Vespa 125: VNL2
Vespa 150 GL: VLA-VBA1-VBB1T
Vespa 150 Gs: VS5T
Vespa 160 Gs: VSB1T
Vespa 180 Ss: VSC1T
(R.O. 084803)



16 368 0343 



**TRASPARENTE CONTACHILOMETRI
SPEEDOMETER TRANSPARENT**

Vespa 125 Primavera VMA2T
(R.O. 100619)



16 368 0353 



**TRASPARENTE CONTACHILOMETRI
SPEEDOMETER TRANSPARENT**

Vespa 50 Special V5B3T
(R.O. 610356M)



16 368 0203 



**CORNICI CONTACHILOMETRI
SPEEDOMETER RINGS**

Vespa 125 VNA-VNB
(R.O. 83204)



16 368 0213 



**CORNICI CONTACHILOMETRI
SPEEDOMETER RINGS**

Vespa 50 Special V5A2/3-V5B1/2/3
(R.O. 610355M)



16 368 0223 



**CORNICI CONTACHILOMETRI
SPEEDOMETER RINGS**

Vespa 125 V30



16 368 0233 



**CORNICI CONTACHILOMETRI
SPEEDOMETER RINGS**

Vespa 125 Primavera
150 Super-Gtr-Ts • Sprint-Rally
(R.O. 151837)



16 368 0243 



**CORNICI CONTACHILOMETRI
SPEEDOMETER RINGS**

Vespa 125: VNL2
Vespa 150 GL: VLA-VBA1-VBB1T
Vespa 150 Gs: Vs5t
Vespa 160 Gs: VSB1T
Vespa 180 Ss: VSC1T
(R.O. 084202)





PARTICOLARI CARROZZERIA PIAGGIO

PIAGGIO BODYWORK PARTS

14 264 0500

KIT GOMMINI TELAIO - FRAME RUBBERS KIT

VESPA 50-90	QUANTITÀ QUANTITY	
121830230	Cappuccio candela - <i>Spark plug</i>	1
121830290	Tappo mozzo anteriore - <i>Plug hub</i>	1
121830320	Tassello feritoia volano - <i>Flywheel plug</i>	1
121830340	Asta rubinetto benzina - <i>Tie rod</i>	1
121830350	Ammortizzatore posteriore - <i>Rear damper</i>	1
121830370	Tappo benzina - <i>Fuel cap</i>	1
121830380	Tampone di scontro carter - <i>Buffer</i>	2
121830410	Passacavo telaio - <i>Frame buffer</i>	1
121830430	Clacson - <i>Horn</i>	1
121830490	Sportello motore - <i>Engine door</i>	6
121830460	Fondello bloccasterzo - <i>Lock</i>	1
121830500	Pedale freno - <i>Brake</i>	1
121830530	Rubinetto benzina - <i>Fuel cock</i>	1
121830560	Bobina - <i>Coil</i>	1
121830600	Ammortizzatore anteriore - <i>Front damper</i>	2

 Composto da pezzi 22 - *Made by 22 pcs*
14 264 0510

KIT GOMMINI TELAIO - FRAME RUBBERS KIT

VESPA SPRINT-GL	QUANTITÀ QUANTITY	
121830230	Cappuccio candela - <i>Spark plug</i>	1
121830080	Leva messa in moto - <i>Kick starter lever</i>	1
100706210	Coperchio frizione - <i>Clutch cover</i>	1
121830090	Passacavo - <i>Grommet</i>	1
121830300	Tappo benzina - <i>Fuel cap</i>	1
121830330	Depuratore - <i>Air cleaner</i>	1
121830350	Ammortizzatore posteriore - <i>Rear damper</i>	1
121830360	Passacavo - <i>Grommet</i>	1
121830400	Tampone di scontro carter - <i>Buffer</i>	2
121830430	Clacson - <i>Horn</i>	1
121830450	Pedale freno - <i>Brake pedal</i>	1
121830460	Fondello bloccasterzo - <i>Lock</i>	1
121830510	Tampone motore - <i>Engine Buffer</i>	1
121830520	Tampone motore - <i>Engine buffer</i>	1
121830530	Rubinetto benzina - <i>Fuel cock</i>	1
121830550	Bussola cofano - <i>Cowl bush</i>	2
121830560	Cappuccio bobina - <i>Coil</i>	1

 Composto da pezzi 19 - *Made by 19 pcs*
14 264 0520

KIT GOMMINI TELAIO - FRAME RUBBERS KIT

VESPA PX	QUANTITÀ QUANTITY	
121830230	Cappuccio candela - <i>Spark plug</i>	1
121830080	Leva messa in moto - <i>Kick starter lever</i>	1
100706210	Coperchio frizione - <i>Clutch cover</i>	1
121830090	Passacavo - <i>Grommet</i>	1
121830100	Passacavo - <i>Grommet</i>	1
121830110	Passacavo cofano - <i>Cowl grommet</i>	1
121830300	Tappo benzina - <i>Fuel cap</i>	1
121830330	Depuratore - <i>Air cleaner</i>	1
121830340	Asta rubinetto - <i>Tie rod</i>	1
121830350	Ammortizzatore posteriore - <i>Rear damper</i>	1
121830360	Passacavo telaio - <i>Frame grommet</i>	1
121830400	Tampone di scontro carter - <i>Buffer</i>	2
121830420	Tubetto cofano - <i>Tube cowl</i>	2
121830460	Fondello bloccasterzo - <i>Lock</i>	1
121830470	Soffietto cavo frizione - <i>Clutch cable folding</i>	1
121830480	Pedale freno - <i>Brake pedal</i>	1
121830510	Tampone motore - <i>Engine buffer</i>	1
121830520	Tampone motore - <i>Engine buffer</i>	1

 Composto da pezzi 21 - *Made by 21 pcs*
14 264 0530

KIT GOMMINI TELAIO - FRAME RUBBERS KIT

VESPA PK	QUANTITÀ QUANTITY	
121830230	Cappuccio candela - <i>Spark plug</i>	1
121830290	Tappo mozzo anteriore - <i>Plug hub</i>	1
121830340	Asta rubinetto benzina - <i>Tie rod</i>	1
121830370	Tappo benzina - <i>Fuel cap</i>	1
121830390	Tampone di scontro carter - <i>Buffer</i>	1
121830480	Pedale freno - <i>Brake pedal</i>	1
121830490	Sportello motore - <i>Engine door</i>	6
121830530	Rubinetto benzina - <i>Fuel cock</i>	1
121830560	Bobina - <i>Coil</i>	1
121830570	Cappuccio Centralina - <i>Ignition Device</i>	1
121830600	Ammortizzatore anteriore - <i>Front damper</i>	2

 Composto da pezzi 17 - *Made by 17 pcs*



14 267 0040 

TAPPETINO IN GOMMA
RUBBER MAT
PIAGGIO: Vespa 50-90 • Primavera



14 267 0050 

TAPPETINO IN GOMMA
RUBBER MAT
PIAGGIO: Vespa 125 Et3



14 267 0060 

TAPPETINO IN GOMMA
RUBBER MAT
PIAGGIO: Vespa Px 125-150-200



14 267 0070 

TAPPETINO IN GOMMA
RUBBER MAT
PIAGGIO: Vespa Pk 50



14 267 0080 

TAPPETINO IN GOMMA
RUBBER MAT
PIAGGIO: Vespa Pk • XL 50



14 267 0090 

TAPPETINO IN GOMMA
RUBBER MAT
PIAGGIO: Vespa 150 GL • Sprint



14 267 0100 

TAPPETINO IN GOMMA
RUBBER MAT
LAMBRETTA: Li • DL



14 267 0120 

TAPPETINO IN GOMMA
RUBBER MAT
PIAGGIO: Vespa Sprint • GL





PARTICOLARI CARROZZERIA PIAGGIO

PIAGGIO BODYWORK PARTS

14 267 0020



TAPPETINO CENTRALE IN GOMMA
RUBBER MAT

PIAGGIO: Vespa Px 1° serie
(R.O. 180052)



14 267 0030



TAPPETINO CENTRALE IN GOMMA
RUBBER MAT

PIAGGIO 125: Vespa Primavera • Et3
(R.O. 100445)



14 267 0010



TAPPETINO CENTRALE IN GOMMA
RUBBER MAT

PIAGGIO: Vespa GL 150 • Sprint • Sprint
veloce Rally
(R.O. 085072)



14 267 0130



TAPPETINO CENTRALE IN PLASTICA
PLASTIC MAT

PIAGGIO: Vespa Px T5 VNX5T
(R.O. 226093)



14 268 0300



TAPPETINO CENTRALE IN PLASTICA
PLASTIC MAT

PIAGGIO: Vespa 50 Pk XL V5X3
(R.O. 253014)



14 266 0200



COPPIA LISTELLI ACCIAIO INOX
FLOOR RUNNERS FOR FLOOR MAT

PIAGGIO: Vespa GL 150 • Sprint 150 • Super
150 • Vespa 150 Mod. 59 • Vespa 125 Mod. 62
Vespa Gs 160 62-64 • Gtr 125 • Rally 180-200
(R.O. 085073/74)



14 266 0210



COPPIA LISTELLI ACCIAIO INOX
FLOOR RUNNERS FOR FLOOR MAT

PIAGGIO: Vespa 50-90 • Primavera Et3
(R.O. 100446/7)



14 266 0220



COPPIA LISTELLI ACCIAIO INOX
FLOOR RUNNERS FOR FLOOR MAT

PIAGGIO: Vespa Px 125-150-200
(R.O. 180048)



12 183 0090 **PASSACAVO TUBO BENZINA****FUEL TUBE GROMMET****PIAGGIO:** Vespa Px
(R.O. 084262)12 183 0100 **PASSACAVO - GROMMET****PIAGGIO:** Vespa Px
(R.O. 092774)12 183 0110 **PASSACAVO COFANO MOTORE****COWL GROMMET****PIAGGIO:** Vespa Px
(R.O. 156946)12 183 0360 **PASSACAVO TELAIO**
GROMMET**PIAGGIO:** Vespa Pxe 125-150-200
VNX2-VLX2-VSX1
(R.O. 048171)12 183 0410 **PASSACAVO TELAIO**
FRAME GROMMET**PIAGGIO:** Vespa 50-90-Primavera Et3
V5A1-V5B1-V5B2-V5SA1-V9A1-VMA2-VMB1
(R.O. 070219)12 183 0830 **PASSACAVO TELAIO**
FRAME GROMMET**PIAGGIO:** Vespa 50-125 Pk
V5X1T-VMX1T
(R.O. 241071)12 183 0330 **TAPPO DEPURATORE - PLUG AIR CLEANER****PIAGGIO:** Vespa Px 125-150-200 Pxe
VNX - VLX - VBX - VNX2 - VLX2 - VSX1
(R.O. 050274)12 183 0040 **GOMMINO ASTA RUBINETTO**
FUEL ROD RUBBER**PIAGGIO 125-150-200:** Vespa Px • Px E
(R.O. 194631)12 183 0340 **GOMMINO ASTA RUBINETTO NERA**
FUEL ROD RUBBER (BLACK COLOUR)**PIAGGIO:** Vespa 50-90-Primavera Et3
V5A1-V5B1-V5B2-V5SA1-V9A1-VMA2-VMB1
(R.O. 132538-047460)12 183 0530 **GUARNIZIONE RUBINETTO BENZINA**
FUEL TAP GASKET**PIAGGIO:** Vespa 50-90-125 Primavera -Et3-150
GL-Gs-160 Gs-180 Ss
V5A-V5A1T-V5SS1T-V9A1T-V9SS1T-V33TVM1/
2T-VU1T-VN1/2T-VNA1T-VNB1/2/3/4/5/T-VNC1T-
VMA1T-VNL2T-VB1T-VBA1-VBB1TVBC-VLA1T-
VS1T-VSB1T-VSC1T
(R.O. 13836)12 183 0300 **GUARNIZIONE TAPPO BENZINA**
GASKET FUEL CAP**PIAGGIO:** Vespa Px 125-150 • P 200
VNX-VLX-VBX -T5 VNX5T
Vespa 125
VN1-VN2-VNA-VNB
(R.O. 002319)12 183 0370 **GUARNIZIONE TAPPO BENZINA**
GASKET FUEL CAP**PIAGGIO:** Vespa 50-90-Primavera Et3
V5A1-V5B1-V5B2-V5SA1-V9A1-VMA2-VMB1
(R.O. 071734)



PARTICOLARI CARROZZERIA PIAGGIO

PIAGGIO BODYWORK PARTS

12 183 0490



TAMPONE COFANO MOTORE SIDE PANEL BUFFER

Vespa 50-90-Primavera Et3
V5A1-V5B1-V5B2-V5SA1-V9A1-VMA2-VMB1
(R.O. 232222)



14 264 0543



KIT GOMMINI PANNELLI KIT RUBBERS FRAME

PIAGGIO 150: Vespa Sprint VLB1T



14 264 0553



KIT GOMMINI PORTELLO KIT RUBBER DOOR

PIAGGIO 50: Vespa 1 serie V5A1T



14 264 0563



KIT GOMMINI PORTELLO KIT RUBBER DOOR

PIAGGIO 50: Vespa special V5B3T



14 264 0573



KIT GOMMINI COFANO KIT RUBBER COWLS

PIAGGIO 125-150-200: Vespa Px
VN1T-VLX1T-VSX1T



14 264 0583



KIT GOMMINI COFANO KIT RUBBER COWLS

PIAGGIO 125-150-200: Vespa Px
VN1T-VLX1T-VSX1T



12 183 0420



TUBETTO COFANO SIDE PANEL RUBBER TUBE

PIAGGIO 125-150-200: Vespa Px • P200 E
VNX-VLX-VBX -T5 VNX5T
Vespa Pxe VNX2-VLX2-VSX1
(R.O. 024021)



12 183 0590



TAMPONE - BUFFER

PIAGGIO 125-150-200: Vespa Px • T5 • Pxe
Arcobaleno • Cosa
(R.O. 149908)



12 181 0863



GOMMINI COFANI - RUBBER HOOKS

PIAGGIO 125-150-200: Vespa Px
VNX-VLX-VSX-VNX2-VLX2-VSX2
(R.O. 178689)



12 183 0620



PIAGGIO 50-90-125: Vespa Primavera Et3
V5A1-V5A2T-V5B1T-V9A1-VMB1
(R.O. 161125)



12 183 0733



CINGHIA BATTERIA - BELT

PIAGGIO 125-150-200: Vespa Px- Cosa-T5-
Pxe Arcobaleno-VNX-VLX-VSX-VNX5T-VLR1T-
VLR-VSR1-VNX2-VLX2-VSX2
(R.O. 218812)



14 274 0140



CINGHIA FERMA PORTIERA SAFETY BELT FOR DOOR

PIAGGIO 50: Ape tutti i tipi
200: Ape Car P2-P3 78-85 • Ape Mp P501-P601
(R.O. 175074)



12 183 0450

GOMMINO PEDALE FRENO
BRAKE PEDAL RUBBER
PIAGGIO: Vespa 125-150 Gs • 160-180 Ss

• Rally 180-200

(R.O. 093100)

12 183 0480

GOMMINO PEDALE FRENO
BRAKE PEDAL RUBBER
PIAGGIO: Vespa Px • Pe - VNX - VLX - VSX

(R.O. 182051)

12 183 0500

PIAGGIO 125: Vespa Primavera-Et3

V5SS-V5A1T-V9SS-VNA1/2T-VMB1

(R.O. 100426)

12 183 0630

TAMPONE CAVALLETTO
CENTRAL STAND BUFFER
PIAGGIO 125-150-200: Vespa Px Arcobaleno-T5

VNX-VLX-VSX-VNX5T-VLR1T-VLR-VSR1-VNX2-

VLX2-VSX2

(R.O. 174773)

12 183 0080

GOMMINO LEVA MESSA IN MOTO
KICKSTART RUBBER
PIAGGIO: Vespa tutti i tipi - *All models*

(R.O. 241004)

12 183 0430

GUARNIZIONE CLACSON COLORE NERA
HORN GASKET BLACK COLOUR
PIAGGIO 125: Vespa Primavera VMA2

(R.O. 120798)

12 183 0431

GUARNIZIONE CLACSON
HORN GREY GASKET
PIAGGIO 50: Vespa N-L-R V5A1T

(R.O. 92468)

12 183 0310

TAPPO GOMMA FERITOIA VOLANO
FLYWHEEL SLOT RUBBER PLUG
PIAGGIO 200: Vespa Pe VSX

(R.O. 133652)

12 183 0320

TAPPO GOMMA FERITOIA VOLANO
FLYWHEEL SLOT RUBBER PLUG
PIAGGIO 50-90: Vespa Primavera Et3

V5A1-V5B1-V5B2-V5SA1-V9A1-VMA2-VMB1

(R.O. 110162)

12 181 0853

SUPPORTO ELASTICO RELAIS FRECCHE
RELAIS ELASTIC BRACKET
PIAGGIO 125-150-200: Vespa Px T5 VNX5T

• Cosa VNR-VLR-VSR

(R.O. 291017 • 290222)

12 183 0470

SOFFIETTO PROTEZIONE CAVI
RUBBER BELLOW CABLE
PIAGGIO: Vespa Px • Pe • Pxe Arcobaleno

VNX - VLX - VSX - VNX2 - VLX2 - VSX2

(R.O. 156425)

12 183 0460

FONDELLO BLOCCA STERZO
GASKET FOR CYLINDER LOCK
PIAGGIO 125-150-200: Vespa Px

VNX - VLX - VSX

(R.O. 174092)





PARTICOLARI CARROZZERIA PIAGGIO

PIAGGIO BODYWORK PARTS

12 183 0820



TAMPONE SUPERIORE AMMORTIZZATORE
SHOCK ABSORBER BUFFER
PIAGGIO 125-150-200: Vespa Px
(R.O. 174085)



12 183 0800



TAMPONE SUPERIORE AMMORTIZZATORE
SHOCK ABSORBER BUFFER
PIAGGIO 50: Vespa 1° Serie
Ø Int.13mm



12 183 0810



TAMPONE SUPERIORE AMMORTIZZATORE
SHOCK ABSORBER BUFFER
PIAGGIO 125-150: Vespa
(R.O. 015019)



12 165 0073



TAPPO VOLANO - FLYWHEEL CAP
PIAGGIO 125-150-200: Vespa Px
VNX-VLX-VSX
• Cosa VNR-VLR-VSR
(R.O. 226990)



12 183 0790



TAMPONE AMMORTIZZATORE
SHOCK ABSORBER BUFFER
PIAGGIO 50: Vespa 1° Serie
VSA1T
Ø12 (Foro - Hole)



12 183 0600



TAMPONE AMMORTIZZATORE
SHOCK ABSORBERS PLUG
PIAGGIO 50-90-125: Vespa Primavera • Et3
(R.O. 57012)



12 183 0350



GOMMINO AMM. POSTERIORE
BUFFER REAR SHOCK ABSORBER
PIAGGIO 50-90: Vespa Primavera Et3
VSA1-V5B1-V5B2-V5SA1-V9A1-VMA2-VMB1
125: Vespa VNA-VNB
(R.O. 040316)



12 187 0040



TAPPO SUL MANUBRIO
HANDLEBAR COVER PLUG
GILERA 50: Ice 01
PIAGGIO 50: Liberty 97-02 • 4T 00-02
100: Free 02
(R.O. 562897)



12 183 0290



TAPPO MOZZO ANTERIORE
FRONT HUB PLUG
PIAGGIO 50-90-125: Vespa Primavera
VSA1/2T-V5B1/3T - V5A 3T - V5B2T - V5B4T -
V5SS1T
(R.O. 071053)



14 274 0120



MANIGLIA IN PLASTICA PER PORTA LATERALE
HANDLE LATERAL DOOR
PIAGGIO 50: Ape 80-89
(R.O. 176268)



14 274 0130



MANIGLIA IN PLASTICA PER PORTA LATERALE
HANDLE LATERAL DOOR
PIAGGIO 50: Ape
(R.O. 255813)





14 268 0250 

PIAGGIO 125-150-200: Vespa Px 1° serie
VNX-VLX-VSX
(R.O. 139829)



14 268 0260 

PIAGGIO 125-150-200: Vespa Pxe Arcobaleno
VNX-VLX-VSX-VNX2-VLX2-VSX2
(R.O. 904600)



14 268 0270 

PIAGGIO 125-150-200: Vespa Px 1° serie
(R.O. 174014)



14 268 0310 

PIAGGIO: Vespa Px freno a disco
(R.O. 6224306)



14 268 0430 

PIAGGIO 50-125: Vespa Pk
(R.O. 178933)



14 268 0440 

PIAGGIO 50: Vespa Pk
(R.O. 178637)



14 268 0450 

PIAGGIO 50-125: Vespa Pk XL
(R.O. 226730)



14 268 0460 

PIAGGIO 50: Vespa FL 90 • Vespa FL2 Automatica 90-91 • Vespa FL2 Hp 91-97
125: Vespa FL 89-90
(R.O. 921700)



14 268 0470 

PIAGGIO 50: Vespa Lx 2T Touring 30 Km 10-13 • Vespa Lx 2T 05-13 • Vespa Lx 4T-4V Touring 10-13 • Vespa Lx 4T-4V 09-13
125: Vespa Lx 4T 3V ie Touring 12-13 • Vespa Lx 4T Eu3 Touring 10-11 • Vespa Lx 4T FL 09 • Vespa Lx Eu3 ie 09-11 • Vespa Lx Eu3 06-08 • Vespa Lx 05-06 • Vespa Lx 05-06
150: Vespa Lt 4T 3V ie 14 • Vespa Lx 4T 3V ie Touring 12-13 • Vespa Lx 4T FL 09 • Vespa Lx Eu3 ie 09-11 • Vespa Lx Eu3 06-08 • Vespa Lx touring 10-12 • Vespa Lx 05-06
(R.O. 652935)



14 268 0480 

PIAGGIO 300: Gts
(R.O. 1B001185)



14 268 0490 

PIAGGIO 50: Liberty 4T 00-02 • Liberty 97-05 • Vespa Et2 Iniezione 97-00 • Vespa Et2 97-05 • Vespa Et4 00-05
125: Liberty 99-12 • Vespa Et4 96-02
(R.O. 4272005)





PARTICOLARI CARROZZERIA PIAGGIO

PIAGGIO BODYWORK PARTS

14 262 0050



COPERCHIO PLASTICA GRIGIO
GREY PLASTIC HUB COVER

PIAGGIO: Vespa Px
(R.O. 178048)



14 262 0051



COPERCHIO PLASTICA NERO
BLACK PLASTIC HUB COVER

PIAGGIO: Vespa Px
(R.O. 232927)



14 262 0040



COPERCHIO MOZZO-ALLUMINIO
ALUMINIUM HUB COVER

PIAGGIO 50-90-125: Vespa Primavera -Et3
V5A1-V5B1-V5B2-V5SA1-V9A1-VMA2-VMB1-
VMX1T
(R.O. 070177)



14 262 0041



COPERCHIO MOZZO-ALLUMINIO
ALUMINIUM HUB COVER

PIAGGIO 50-90-125: Vespa Primavera -Et3
V5A1-V5B1-V5B2-V5SA1-V9A1-VMA2-VMB1-
VMX1T
(R.O. 070177)



24 648 0440



SPIE INDICATRICI - INDICATOR LIGHTS

PIAGGIO 125-150-200: Vespa Px I° serie
VNX-VLX-VSX-VLB-VBC
(R.O. 139980-163682)



14 268 0410



COPERCHIO CONTACHILOMETRI
SPEEDOMETER COVER

PIAGGIO 50: Vespa Special Elestart
(R.O. 123678)



14 260 0040



MODANATURA CALANDRA
STEERING MOULDING

PIAGGIO 50: Vespa 50 Special- Elestart
V5B1-V5A3T
(R.O. 123576)



14 260 0200



GRIGLIA CALANDRA - HORN COVER GRILL

PIAGGIO 125-150: Vespa Px modello freno a
disco VNX2T-VLX1-VSX1T
(R.O. 564221)



14 260 0201



GRIGLIA PER CALANDRA VESPA NERA
HORN COVER GRILL BLACK COLOUR

PIAGGIO 125-150-200: Vespa Pxe Arcobaleno
(R.O.219119)





14 260 0010 

CALANDRA STERZO
STEERING COLUMN COVER
PIAGGIO 50: Vespa Special • Revival
(R.O. 143593)



14 260 0011 

CALANDRA STERZO
STEERING COLUMN COVER
PIAGGIO 50: Vespa Special • V581
(R.O. 143593)



14 260 0020 

CALANDRA STERZO
STEERING COLUMN COVER
PIAGGIO 125-150-200: Vespa 1 serie
(R.O. 183779)



14 260 0030 

CALANDRA STERZO
STEERING COLUMN COVER
PIAGGIO 125: Vespa Px modello freno a disco
Vespa Px 150 E • 200 E
(R.O. 574651)



14 260 0050 

CALANDRA STERZO
STEERING COLUMN COVER
PIAGGIO 50-125: Vespa Pk Plurimatic - Rush
(R.O. 9007005)



14 260 0060 

CALANDRA STERZO
STEERING COLUMN COVER
PIAGGIO 50-125: Vespa Pk FL - FL2 Automatica
(R.O. 910000)



14 260 0070 

CALANDRA STERZO
STEERING COLUMN COVER
PIAGGIO 125-150-200: Vespa Px Arcobaleno
(R.O. 219118)



14 260 0080 

CALANDRA STERZO
STEERING COLUMN COVER
PIAGGIO 125: Vespa Px T5
(R.O. 232893)



14 260 0090 

CALANDRA STERZO
STEERING COLUMN COVER
PIAGGIO 50-125: Vespa Pk
(R.O. 219564)





PARTICOLARI CARROZZERIA PIAGGIO

PIAGGIO BODYWORK PARTS

14 268 0070



PARAFANGO ANTERIORE PIAGGIO
STEEL FRONT MUDGUARD

PIAGGIO 50-125: Vespa Primavera Et3
(R.O. 183680)



14 268 0080



PARAFANGO ANTERIORE PIAGGIO
STEEL FRONT MUDGUARD

PIAGGIO: Vespa Px-Pe
(R.O. 1774976)



14 268 0130



PARAFANGO ANTERIORE PIAGGIO
STEEL FRONT MUDGUARD

PIAGGIO 125-150-200: Vespa Px Freno a disco - Brake disc Px 98-01
Px 30 anni 07-08
(R.O. 5638116)



14 268 0140



PARAFANGO ANTERIORE PIAGGIO
STEEL FRONT MUDGUARD

PIAGGIO: Vespa Sprint Veloce
(R.O. 120604)



14 268 0150



PARAFANGO ANTERIORE PIAGGIO
STEEL FRONT MUDGUARD

PIAGGIO 50: Pk XL Plurimatic 85-90
• Pk XL Rush 88-89 • Pk XL 85-88
50-125: Pk 82-84
125: Pk XL 86-89
(R.O. 226754)



14 268 0320



PARAFANGO ANTERIORE
FRONT MUDGUARD

PIAGGIO 50: Vespa Et4 00-05 • Vespa Et2 97-05
• Vespa Et2 Iniezione 97-00 •
125: Vespa Et4 96-02
(R.O. 8249005)



14 268 0330



PARAFANGO ANTERIORE
FRONT MUDGUARD

PIAGGIO VESPA 50: N 89-90 • FL2 Hp 91-97 •
FL2 Automatica 90-91 • FL 90 •
125: FL 89-90
(R.O. 911100)



14 268 0340



PARAFANGO ANTERIORE
FRONT MUDGUARD

PIAGGIO VESPA 50: Lxv 2T Navy 08 • Lxv 2T
06-09 • Lx 4T 4V Touring 10-13 • Lx 4T 4V 09-
13 • Lx 4T 05-08 • Lx 2T Touring 30 Km 10-13
• Lx 2T 05-13 • **125:** Lxv ie 4T 10-13 • Lxv 4T
Navy Eu3 07-08 • Lxv 4T Eu3 06-09 • Lx Eu3 ie
09-11 • Lx Eu3 06-08 • Lx 4T FL 09 • Lx 4T Eu3
Touring 10-11 • Lx 4T 3V ie Touring 12-13 • Lx
05-06 • Lx Touring 10-12 • Lx Eu3 ie 09-11 • Lx
Eu3 06-08 • Lx 4T 3V ie Touring 12-13
(R.O. 666528)



14 268 0350



PARAFANGO ANTERIORE
FRONT MUDGUARD

PIAGGIO VESPA 125: Gts Eu3 07-12 • Gts 4T ie
Super 09-15 • Granturismo Eu3 06-07 • **250:** Gts
05-14 • **300:** Gts Super Sport 10-13 • Gts Super
08-15 • Gts ie Touring 11-15
(R.O. 651029)





14 268 0360 

PARAFANGO ANTERIORE

FRONT MUDGUARD

PIAGGIO: Liberty >04

Ruota 16" Stretta

(R.O. 5749525)



14 268 0370 

PARAFANGO ANTERIORE

FRONT MUDGUARD

PIAGGIO: Liberty 04-08

Ruota 16" Larga



14 268 0380 

PARAFANGO ANTERIORE

FRONT MUDGUARD

PIAGGIO 125: Beverly Tourer Eu3 07-10 •

250: Beverly Tourer Eu3 07-09 • Beverly Eu3 Mic

07 • Beverly Cruiser 07-09 • 300: Beverly Tourer

Eu3 09-10 • 400: Beverly Tourer Eu3 08-10 •

500: Beverly Cruiser 07-12

(R.O. 653588)



14 268 0390 

PARAFANGO ANTERIORE

FRONT MUDGUARD

PIAGGIO 125: Beverly Rst 4T 4V ie Eu3 10-15 •

350: Beverly 4T 4V ie Eu3 Sport Touring 11-14

(R.O. 667197)



14 268 0200 

PARAFANGO ANTERIORE

FRONT MUDGUARD

PIAGGIO 50: Ciao Px

(R.O. 187170)



14 268 0210 

PARAFANGO POSTERIORE

REAR MUDGUARD

PIAGGIO 50: Ciao Px

(R.O. 188095)



14 268 0220 

PARAFANGO ANTERIORE INOX

FRONT MUDGUARD INOX TYPE

PIAGGIO 50: Ciao Px

(R.O. 233678)



14 268 0230 

PARAFANGO POSTERIORE INOX

REAR MUDGUARD INOX TYPE

PIAGGIO 50: Ciao Px

(R.O. 188746)



14 268 0240 

PARAFANGO ANTERIORE

FRONT MUDGUARD

PIAGGIO 50: Si • FL2

(R.O. 267651)



14 268 0120 

PARAFANGO POSTERIORE PLASTICA CON

SAGOMA PORTATARGA

PLASTIC REAR MUDGUARD WITH PLATE

HOLDER

PIAGGIO: Pk 82-84 Si FL2

(R.O. 924800)





PARTICOLARI CARROZZERIA PIAGGIO

PIAGGIO BODYWORK PARTS

14 266 0060



CRESTA PARAFANGO ALLUMINIO
ALLOY FENDER CREST
PIAGGIO 50: Vespa Special
(R.O. 124708)



14 266 0070



CRESTA PARAFANGO ALLUMINIO
ALLOY FENDER CREST
PIAGGIO 125-150-160 Vespa Gs
(R.O. 097214)



14 266 0080



CRESTA PARAFANGO ALLUMINIO
ALLOY FENDER CREST
PIAGGIO 50: Vespa
90-125: Vespa Primavera Et3
(R.O. 150070)



14 266 0030



SERIE STRISCE PEDANA
FLOOR RUNNER KIT
PIAGGIO 50-90-125: Vespa ET3 in alluminio
Completa di gomma e puntalini
Alloy with rubber and terminals
(R.O. 610232M)



14 266 0040



SERIE STRISCE PEDANA
FLOOR RUNNER KIT
PIAGGIO: Vespa Px Pe Arcobaleno in alluminio
Completa di gomma e puntalini
Alloy with rubber and terminals
(R.O. 610231M)



14 266 0090



SERIE STRISCE PEDANA
FLOOR RUNNER KIT
PIAGGIO 150-180-200: Vespa GL-Sprint-
Sprint Veloce Rally
VLA-VLB-VLB1T-VNL2T-VSD1T-VSE1T
(R.O. 610233M)



14 256 0050



SACCA PORTATUTTO - TOOLBOX
PIAGGIO 50-125: Vespa Pk • FL • Hp • Rush N
(R.O. 219383)



14 256 0030



SACCA PORTATUTTO - TOOLBOX
PIAGGIO 50-90: Vespa
125: Vespa Primavera • Et3
(R.O. 100389)





14 268 0090 

PROTEZIONE POSTERIORE SCOCCA
REAR FRAME PROTECTION

PIAGGIO: Vespa Px • Pe Arcobaleno
(R.O. 219110)



14 268 0160 

PROTEZIONE POSTERIORE SCOCCA
REAR FRAME PROTECTION

PIAGGIO 125-150-200: Vespa Pxe
VN2-VLX2-VSX2
(R.O. 219110)



14 268 0280 

PARASPRUZZO
MUDGUARD FLAP

PIAGGIO 50: Vespa FL2 V5N1
(R.O. 266308)



14 268 0290 

PARASPRUZZO
MUDGUARD FLAP

PIAGGIO 50: Vespa FL 2 V5N1
(R.O. 256940)



14 268 0180 

PROTEZIONE RUOTA 10"
WHEEL COVER

PIAGGIO: Vespa Px-Pe VN2-VLX-VSX
(R.O. 226824)



14 268 0170 

PARASPRUZZO
MUDGUARD FLAP

PIAGGIO: Varie Vespa - Various Vespa
(R.O. 610062M)



14 256 0100 

COPPIA COPERTURE LATERALI
COUPLE COVERS

PIAGGIO 50: Ciao con variat. colore nero 80-88
Ciao with autom.speed black colour 80-88
(R.O. 9223005-9224005)



14 256 0150 

COPPIA POGGIAPIEDI NERI
BLACK FLOOR BOARD COUPLE

PIAGGIO 50: Si • Si FL 2
(R.O. 228989)



14 256 0090 

CP. COPERTURE LATERALI COPRIMOTORE
COUPLE PROTECTION FRAME

PIAGGIO 50: Si • FL2
(R.O. 497488)



14 268 0420  

PARASPRUZZO - FLAP

PIAGGIO 50: Si FL2
(R.O. 269208)





PARTICOLARI CARROZZERIA PIAGGIO

PIAGGIO BODYWORK PARTS

12 181 0033



GANCIO PORTABORSE NERO
BLACK BAG HOOK

PIAGGIO 125: Vespa T5 VNX5T

Nero/Black

(R.O. 227153)



12 181 0030



GANCIO PORTABORSA ZINCATO
HOOK FOR BAG GALVANIZED

PIAGGIO: Vespa tutti i modelli

(R.O. 057468)



12 181 0040



GANCIO PORTACASCO
HELMET HOOK

PIAGGIO: Vespa Px • Pe

VNX - VLX - VSX - VNX2 - VLX2 - VSX2

(R.O. 219587)



12 181 0050



GANCIO PORTABORSA
BAG HOOK

PIAGGIO: Vespa

(R.O. 011653)



12 153 0190



PEDALE E PIASTRA FRENO COMPLETO
BRAKE PEDAL ASSY

PIAGGIO: Vespa Px • Pe

VNX - VLX - VSX - VNX2 - VLX2 - VSX2

(R.O. 182049-138474)



12 153 0313



PEDALE FRENO
BRAKE PEDAL

PIAGGIO 150: Vespa GL-Sprint-Super- Sprint
veloce VLB-VLA-VBC

(R.O. 094451)



12 185 8400



PERNO ANCORAGGIO SELLA TIPO CORTO
SADDLE PIN TYPE SHORT

PIAGGIO 50-90: Vespa Primavera Et3

V5A1-V5B1-V5B2-V5SA1-V9A1-VMA2-VMB1

(R.O. 56729)



12 185 8410



PERNO ANCORAGGIO SELLA TIPO LUNGO
SADDLE PIN TYPE LONG

PIAGGIO 50-90: Vespa Primavera Et3

V5A1-V5B1-V5B2-V5SA1-V9A1-VMA2-VMB1

(R.O. 139318)



12 185 8420



PERNO ANCORAGGIO SELLA
SADDLE PIN

PIAGGIO 125-150-200: Vespa Px P200E

VNX-VLX-VBX -T5 VNX5T

Vespa Pxe 125-150-200 VNX2-VLX2-VSX1

(R.O. 240165)



14 264 0050
PROFILO SCUDO PLASTICA
BLACK LEGSHIELD FRAME PROFILE
PIAGGIO: Vespa Px • Pe • T5

 Colore nero - *Black colour*

(R.O. 226097)

14 264 0040
PROFILO SCUDO PLASTICA
BLACK LEGSHIELD FRAME PROFILE
PIAGGIO: Vespa Px • Pe

Metallizzato grigio - *Silver colour*

(R.O. 218944)

14 264 0130
PROFILO SCUDO IN ALLUMINIO
ALUMINIUM LEGSHIELD FRAME PROFILE
PIAGGIO: Vespa 50 • 50 Special • Vespa 90 • Vespa 125 Primavera • Et3

Tipo originale

Original type

(R.O. 070416)

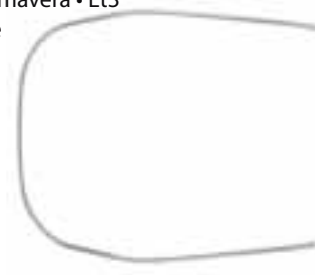
14 264 0220
PROFILO SCUDO GOMMA
LEGSHIELD FRAME PROFILE
PIAGGIO: Vespa 50 Pk XL-125 - V5N1T-V5N2T-V5X5T-V5X4T-V5X3T-VMX7T-VMX6T

(R.O.256938)

14 264 0190
PROFILI SCUDO SINISTRO
LEFT PROFILE LEGSHIELD
PIAGGIO 125: Granturismo Eu3 06-07 • Granturismo 03-07 • Gts 4T ie Super 09-04 • Gts Eu3 07-12 • Gtv 4T Navy Eu3 08 • Gtv 06-08

200: Gt Granturismo 06-07

250: Gt 60 Eu3 06-07 • Gts Abs 05-12 • Gts 05-13 • Gtv 4T Navy Eu3 07 • Gtv 05-09

300: Gts ie Touring 11-12 • Gts ie 12-14 • Gts Super Sport 10-13 • Gts Super 08-14 • Gtv 4T 4V ie 10-13 • Gtv Via Montenapoleone 10
 (R.O. 577180)

14 264 0180
PROFILI SCUDO DESTRO
RIGHT PROFILE LEGSHIELD
PIAGGIO 125: Granturismo Eu3 06-07 • Granturismo 03-07 • Gts 4T ie Super 09-04 • Gts Eu3 07-12 • Gtv 4T Navy Eu3 08 • Gtv 06-08

200: Gt Granturismo 06-07

250: Gt 60 Eu3 06-07 • Gts Abs 05-12 • Gts 05-13 • Gtv 4T Navy Eu3 07 • Gtv 05-09

300: Gts ie Touring 11-12 • Gts ie 12-14 • Gts Super Sport 10-13 • Gts Super 08-14 • Gtv 4T 4V ie 10-13 • Gtv Via Montenapoleone 10
 (R.O. 577181)

14 264 0210
PROFILI SCUDO SINISTRO
LEFT PROFILE LEGSHIELD
PIAGGIO 50: Lx 2T Touring & 30 Km 10-13 • Lx 2T 05-08 • Lx 2T 09-13 • Lx 4T-4V Touring 10-13 • Lx 4T-4V 09-13 • Lx 4T 05-08 • Lxv 2T Nav y 08 • Lxv 2T 06-09 • S2t & college 07-12 • S4t 4v & College 08-12

125: Lx 4T 3V ie - Touring 12-13 • Lx 4T Eu3 Touring 10-11 • Lx 4T FL 09 • Lx Eu3 ie 09-11 • Lx Eu3 06-08 • Lx 05-06 • Lxv 4T Eu3 06-09 • Lxv 4T Navy Eu3 07-08 • Lxv ie 4T 10-13 • S 4T 3V ie 12 • S 4T Eu3 07-08 • S 4T ie & College 09-11

150: Lx 4T 3V ie - Touring 12-13 • Lx 4T FL 09 • Lx Eu3 ie 09-11 • Lx Eu3 06-08 • Lx Touring 10-12 • Lx 05-06 • S 4T ie & College 09-12 • S 4T 08-09
 (R.O. 622187)

14 264 0200
PROFILI SCUDO DESTRO
RIGHT PROFILE LEGSHIELD
PIAGGIO 50: Lx 2T Touring & 30 Km 10-13 • Lx 2T 05-08 • Lx 2T 09-13 • Lx 4T-4V Touring 10-13 • Lx 4T-4V 09-13 • Lx 4T 05-08 • Lxv 2T Navy 08 • Lxv 2T 06-09 • S2t & college 07-12 • S4t 4v & College 08-12

125: Lx 4T 3V ie - Touring 12-13 • Lx 4T Eu3 Touring 10-11 • Lx 4T FL 09 • Lx Eu3 ie 09-11 • Lx Eu3 06-08 • Lx 05-06 • Lxv 4T Eu3 06-09 • Lxv 4T Navy Eu3 07-08 • Lxv ie 4T 10-13 • S 4T 3V ie 12 • S 4T Eu3 07-08 • S 4T ie & College 09-11 • **150:** Lx 4T 3V ie - Touring 12-13 • Lx 4T FL 09 • Lx Eu3 ie 09-11 • Lx Eu3 06-08 • Lx Touring 10-12 • Lx 05-06 • S 4T ie & College 09-12 • S 4T 08-09
 (R.O. 622188)



PARTICOLARI CARROZZERIA PIAGGIO

PIAGGIO BODYWORK PARTS



14 264 0070 

**PROFILO IN GOMMA COFANO LATERALE
SIDE PANEL BLACK RUBBER STRIP**

PIAGGIO: Vespa Px-Pe
(Rotoli da 12 Mt Nero - 12 Mt roll black)

14 264 0100 

**PROFILO IN GOMMA SCUDO
FRAME BLACK RUBBER STRIP**

PIAGGIO 50: Vespa Et3 • Px-Pe
(CM 165 Nero - 165 Cm Black)

14 264 0080 

**PROFILO IN GOMMA
WINDSHIELD BLACK RUBBER STRIP
PER CUPOLINO STANDARD**

(Rotoli da 12 Mt Nero - 12 Mt roll black)

14 264 0110 

**PROFILO IN GOMMA
TRA BAULETTO E SCUDO
RUBBER PROFILE PACK**

Vespa Px • Pe (Cm 160 Nero - 160 Cm Black)
(R.O. 219165)

14 264 0060 

**PROFILO IN GOMMA BORDO SCUDO
BLACK RUBBER STRIP**

PIAGGIO 50: Vespa Et3 Px-Pe-Pk
(Rotoli da 8 Mt Nero - 8 Mt roll black)

14 264 0090 

**PROFILO IN GOMMA PER FILTRO ARIA
AIR FILTER RUBBER STRIP**

PIAGGIO 50-150: Vespa • Px
(Rotoli da 10 Mt Nero - 10 Mt roll black)
(R.O. 058853-279882)

14 264 0120 

**PROFILO COFANO LATERALE
SIDE PANEL BLACK RUBBER STRIP**

PIAGGIO: Vespa Px Arcobaleno
(Cm 110 Nero - 110 Cm Black)

14 264 0140 

**PROFILO IN GOMMA PEDANA
FLOOR RUNNER RUBBER**

PIAGGIO 50-90-125: Vespa Primavera • Et3
V5A1-V5B1-V5B2-V5SA1-V9A1-VMA2-VMB1-
VMX1T
(R.O. 154777)

14 264 0150 

**PROFILO IN GOMMA PEDANA
FLOOR RUNNER RUBBER**

PIAGGIO 150: Vespa Sprint • GL • Sprint Velo-
ce • Super
180-200: Rally VLA-VLB-VSD1T-VSE1T
(R.O. 94625)

14 264 0160 

**PROFILO IN GOMMA PEDANA
FLOOR RUNNER RUBBER**

Vespa Px • Pe • Pk - VNX - VSX - VLX
(R.O. 154778)

14 264 0170 

**PROFILO COFANO 3 MT
3 MT SIDE PANEL RUBBER SCRIPT**

PIAGGIO 125-150: Vespa Gs - V30-V33T-VM1-
2T-VN1-2T-VNA1-2T-VNB1-2-3-4-5-6-VL1-2-3-
VB1T-VBA1TVBB1- 2T-VS1-2-3-4-5
(R.O. 011751)

14 264 0101 

PROFILO SCUDO 165 CM - RUBBER PROFILE

PIAGGIO 50-90-125: Vespa Primavera -Et3
V5A1-V5B1-V5B2-V5SA1-V9A1-VMA2-VMB1-
VMX1T





14 258 0170 

FLANGIA RUOTA POSTERIORE

REAR WHEEL FLANGE

PIAGGIO 50: Ciao • Si • Bravo • Grillo

(R.O. 124963)



12 185 8590 

VITE FISSAGGIO RAPIDO mm 34

FAST LOCK SCREW mm 34

PIAGGIO 50: Ciao • Si

(R.O. 185818)



12 185 8600 

VITE FISSAGGIO RAPIDO mm 31

FAST LOCK SCREW mm 31

PIAGGIO 50: Ciao • Si

(R.O. 132871)



12 189 0120 

MOLLA RITEGNO - SPRING

PIAGGIO 50: Ciao • Si

(R.O. 122957)



12 151 0020 

COPPIA PEDALI

PEDALS PAIR

PIAGGIO: Ciao • Si • Bravo

Grillo • Tipo originale - *Standard type*

(R.O. 191643)



12 185 6150 

CHIAVELLA CON DADO FORATO

KEY FOR MOPED CRANKS

Conf. Da 144 pz. - *144/Pcs Packing*

(R.O. 114 219)



12 153 0210 

COPPIA PEDIVELLE

LH-RH CRANK LEVERS

PIAGGIO: Ciao

(R.O. 180888/9)



12 183 0120 

BUSSOLA PEDALIERA

AXLE BUSH

PIAGGIO: Si

(R.O. 141737)



12 153 0300 

ASSE PEDALIERA

CRANKLE SPINDLE

PIAGGIO: Ciao

(R.O. 188073)





PARTICOLARI CARROZZERIA PIAGGIO

PIAGGIO BODYWORK PARTS

12 173 0020



SERBATOIO BENZINA VESPA
PIAGGIO 50-90-125: Primavera Et3
(R.O. 138617)



26 720 0610



SPAZZOLA TERGICRISTALLO
WIPER BLADE

Lunghezza 380 mm - *Length 380 mm*

PIAGGIO 50: Ape Mix 2T 98-08

220: Ape Mp P501-P601 78-96 • Ape Tm P602
82-83 • Ape Tm P703-P703V FL2 84-05

420: Ape Poker Benzina 93 • Ape Poker Diesel
93-97 • Ape Tm P703-P703V Diesel 87-04
(R.O. 438013)



26 720 0690



SPAZZOLA TERGICRISTALLO
WIPER BLADE

Lunghezza 406 mm - *Length 406 mm*

PIAGGIO 1000: Porter 92-98

1200: Porter Diesel 95-00

1300: Porter 16V Pick Up 98-09 • Porter 16V Van

1400: Porter Pick Diesel 98-05 • Porter Van
Diesel 98-05
(R.O. 438042)



12 173 0010



SERBATOIO OLIO APE
OIL TANK APE

Con indicatore riserva
With reserve indicator

PIAGGIO: Ape
(R.O. 263449)



12 173 0033



SERBATOIO OLIO - OIL TANK

PIAGGIO 125-150-200: Vespa Px Arcobaleno T5
VNX-VLX-VSX-VNX5T-VNX2-VLX2-VSX2
(R.O. 297175)



12 171 0020



SPIA OLIO VESPA - OIL BOWL

PIAGGIO: Vespa Pxe 125-150-200 Arcobale-
no • Vespa Px T5 125 • Vespa Px 125 anni 30 •
Vespa Px 125 -150 modello 11 • Rally 200
(R.O.623140 • 155526)



12 187 0513



PIASTRA AMMORTIZZATORE
SHOCK ABSORBER PLATE

PIAGGIO 125-150-200: Vespa PX T5
VNX-VLX-VSX-VNX5T
(R.O. 174806)



12 168 0083



ASTA STARTER - TIE ROD

PIAGGIO 125-150-200: Vespa PX
VNX-VLX-VSX
(R.O. 580938)



12 181 0063



GANCI COFANI - COWL HOOKS

PIAGGIO 125-150-200: Vespa Px
VNX-VLX-VSX-VNX2-VLX2-VSX2
(R.O. 227229 • 244093)





14 280 0000



PORTAPACCO ANTERIORE CROMATO
CHROMED FRONT CARRIER
PIAGGIO: Vespa Px-Lml (R.o.610271M)



14 280 0010



PORTAPACCO POSTERIORE CROMATO
CHROMED REAR CARRIER
PIAGGIO: Vespa Px • LML
(R.o.610270M)



14 280 0020



PORTABAULETTO POSTERIORE CROMATO
CHROMED CARRIER FOR BAG
PIAGGIO: Vespa Px • LML



14 280 0030



PARAURTI - FRONT BUMPER
PIAGGIO: Vespa Px
(R.O. 610272M)



14 280 0001



PORTAPACCO POSTERIORE NERO
BLACK REAR CARRIER
PIAGGIO: Vespa Px • LML



14 270 0030



PORTABOLLO - ROAD TAX HOLDER
PIAGGIO:
Vari modelli Vespa - Various Vespa models



14 270 0010



PORTATARGA EUROPEO - PLATE HOLDER
In nylon antiurto predisposto per il montaggio su tutte le moto e scooter

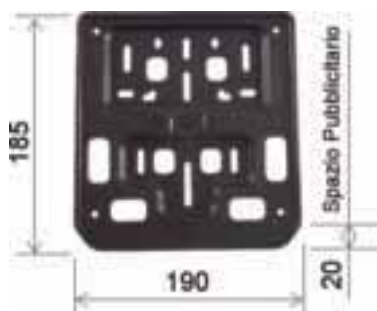

14 270 0040



PORTATARGA EUROPEO - PLATE HOLDER
Per Ciclomotori e Scooter 50 cc



14 270 0350



PORTATARGA EUROPEO IN ACCIAIO
STEEL PLATE HOLDER
170 x 170 mm



14 270 0390



PORTATARGA EUROPEO IN ACCIAIO
STEEL PLATE HOLDER
170 x 170 mm



14 280 0050



ASTA BANDIERA - FLAGPOLE
PIAGGIO:
Vari modelli Vespa - Various Vespa models
(R.O. 610013M)



The background of the entire page is a repeating pattern of various automotive and mechanical icons in a light gray color. These icons include a motorcycle, a battery with a lightning bolt, a wrench and screwdriver, a piston, a gear, a tire, a bolt, a nut, a ball joint, a shock absorber, and a steering knuckle.

RMS

YOUR BEST PARTNER

▶ TARGHETTE

BADGES





TARGHETTE PER SCUDO
FRONT SHIELD BADGE

14 272 0040



SCUDETTO PER SCUDO ANTERIORE
FOR FRONT SHIELD

Esagono 26 mm
(R.O. 152280)



14 272 0100



SCUDETTO PER SCUDO ANTERIORE
FOR FRONT SHIELD

Esagono 31 mm
(R.O. 149876)



14 272 0110



SCUDETTO PER SCUDO ANTERIORE
FOR FRONT SHIELD

Esagono 42 mm
(R.O. 152290)



14 272 0430



SCUDETTO PER SCUDO ANTERIORE
FOR FRONT SHIELD

Scudetto rettangolare
(R.O. 080349)



14 272 0080



SCUDETTO RESINATO ADESIVO PIAGGIO
PER CALANDRA STERZO

PIAGGIO ADHESIVE RESINED SHIELD
FOR HORN COVER

Esagono 27 mm.
(R.O. 295596)



14 272 0020



SCUDETTO RESINATO ADESIVO PIAGGIO
PER CALANDRA STERZO

PIAGGIO ADHESIVE RESINED SHIELD
FOR HORN COVER

(R.O. 295486)



14 272 0050



SCUDETTO RESINATO PER SCUDO ANT.
PIAGGIO RESINED FOR FRONT SHIELD

Esagono 32 mm.
(R.O. 574771)



14 272 0220



TARGHETTA PER SCUDO ANTERIORE
NAMEPLATE FOR FRONT SHIELD

(R.O. 610288M)



14 272 0230



TARGHETTA PER SCUDO ANTERIORE
NAMEPLATE FOR FRONT SHIELD

(R.O. 258148)



14 272 0240



TARGHETTA PER SCUDO ANTERIORE
NAMEPLATE FOR FRONT SHIELD

(R.O. 151727)



14 272 0250



TARGHETTA PER SCUDO ANTERIORE
NAMEPLATE FOR FRONT SHIELD

(R.O. 141345)



14 272 0290



TARGHETTA PER SCUDO ANTERIORE
NAMEPLATE FOR FRONT SHIELD

(R.O. 141345)



TARGHETTE PER SCUDO
FRONT SHIELD BADGE



14 272 0330 

TARGHETTA PER SCUDO ANTERIORE
NAMEPLATE FOR FRONT SHIELD
(R.O. 90556)

Vespa S

14 272 0310 

TARGHETTA PER SCUDO ANTERIORE
NAMEPLATE FOR FRONT SHIELD
(R.O. 151713)

Vespa GT

14 272 0340 

TARGHETTA PER SCUDO ANTERIORE
NAMEPLATE FOR FRONT SHIELD
(R.O. 90496)

Vespa S.I.

14 272 0160 

TARGHETTA PER SCUDO ANTERIORE
NAMEPLATE FOR FRONT SHIELD
(R.O. 577082)



14 272 0400 

TARGHETTA PER SCUDO ANTERIORE
NAMEPLATE FOR FRONT SHIELD
(R.O. 121080)

Super

14 272 0380 

TARGHETTA PER SCUDO ANTERIORE
NAMEPLATE FOR FRONT SHIELD

Sprint

14 272 0170 

TARGHETTA PER SCUDO ANTERIORE
NAMEPLATE FOR FRONT SHIELD
Interasse perni 80 mm - Pin distance 80 mm
(R.O. 152541)

vespa

14 272 0180 

TARGHETTA PER SCUDO ANTERIORE
NAMEPLATE FOR FRONT SHIELD
(R.O. 197601)

vespa

14 272 0440 

TARGHETTA PER CALANDRA ANTERIORE
NAMEPLATE FOR HORN COVER
PIAGGIO 125-150-200: Vespa Px 1 serie
(R.O.181329)

PIAGGIO

14 272 0450 

TARGHETTA PER CALANDRA ANTERIORE
NAMEPLATE FOR HORN COVER
PIAGGIO 125-150-200: Vespa Pxe Arcobaleno
• Vespa Px T5
(R.O.232895)

PIAGGIO

14 272 0520 

TARGHETTA PER SCUDO ANTERIORE
NAMEPLATE FOR FRONT SHIELD
PIAGGIO: Vespa Gt R • VNL2T
(R.O. 151716)



14 272 0640 

TARGHETTA PER SCUDO ANTERIORE
NAMEPLATE FOR FRONT SHIELD
PIAGGIO 50-125: Vespa Pk V5X1T • VMX1T
(R.O. 195629)

vespa



TARGHETTE PER SCUDO
FRONT SHIELD BADGE

14 272 0850 

TARGHETTA PER SCUDO ANTERIORE
NAMEPLATE FOR FRONT SHIELD
PIAGGIO 160: Vespa Gs • VSB1
(R.O. 057182)

Vespa Gs

14 272 0870 

TARGHETTA PER SCUDO ANTERIORE
NAMEPLATE FOR FRONT SHIELD
PIAGGIO: Vespa GL • VS1 (mm 165)
(R.O. 094793)

Vespa GL

14 272 0900 

TARGHETTA PER SCUDO ANTERIORE
NAMEPLATE FOR FRONT SHIELD
PIAGGIO: Vespa VNB
(R.O. 086325)

Vespa

14 272 0880 

TARGHETTA PER SCUDO ANTERIORE BLU
FRONT SHIELD BLUE NAMEPLATE
PIAGGIO: Vespa GL VS1
(R.O. 094793)

Vespa GL

14 272 0920 

TARGHETTA PER SCUDO ANTERIORE VERDE
FRONT SHIELD GREEN NAMEPLATE
PIAGGIO: Vespa VN1T • VN2 • VNA1
(R.O. 023659)

Vespa

14 272 0930 

TARGHETTA PER SCUDO ANTERIORE BLU
FRONT SHIELD BLUE NAMEPLATE
PIAGGIO: Vespa VN1T • VN2 • VNA1
(R.O. 023669)

Vespa

14 272 0810 

TARGHETTA PER SCUDO ANTERIORE
NAMEPLATE FOR FRONT SHIELD
PIAGGIO 50: Vespa • V5A
(R.O. 090944)

Vespa 50

14 272 0820 

TARGHETTA PER SCUDO ANTERIORE
NAMEPLATE FOR FRONT SHIELD
PIAGGIO 150: Vespa VBA • VBB
(R.O. 084809)

Vespa 150

14 272 0830 

TARGHETTA PER SCUDO ANTERIORE
NAMEPLATE FOR FRONT SHIELD
PIAGGIO 150: Vespa Gs • VS1/2/3/4/5
(R.O. 023902)

Vespa Gs

14 272 0840 

TARGHETTA PER SCUDO ANTERIORE
NAMEPLATE FOR FRONT SHIELD
PIAGGIO 150: Vespa Gs • VS1/2/3/4/5
(R.O. 023902)

Vespa Gs

14 272 0860 

TARGHETTA PER SCUDO ANTERIORE
NAMEPLATE FOR FRONT SHIELD
PIAGGIO 150: Vespa GL • VS1
(R.O. 094793)

Vespa GL

14 272 0910 

TARGHETTA PER SCUDO ANTERIORE
NAMEPLATE FOR FRONT SHIELD
PIAGGIO: Vespa VN1T • VN2 • VNA1
(R.O. 023659)

Vespa

TARGHETTE PER SCUDO
FRONT SHIELD BADGE



14 272 0980 

TARGHETTA PER SCUDO ANTERIORE
NAMEPLATE FOR FRONT SHIELD

PIAGGIO 125-150-200: Vespa Px • Arcobaleno • VNX2 • VLX2 • VSX2
(R.O. 194955)

14 272 1200 

TARGHETTA PER SCUDO ANTERIORE
NAMEPLATE FOR FRONT SHIELD

PIAGGIO 50: Vespa S 4T 4V
125: Vespa Gts 4T ie Super • Vespa S 4T 3V ie
300: Vespa Gts Super Sport
(R.O. 672060)

14 272 0890 

TARGHETTA PER SCUDO ANTERIORE
NAMEPLATE FOR FRONT SHIELD

PIAGGIO: Vespa VNB
(R.O. 086325)

14 272 1190 

TARGHETTA PER SCUDO ANTERIORE
NAMEPLATE FOR FRONT SHIELD

PIAGGIO 150: Vespa Sprint-Super-Rally Vlb1t-Vbc1t-Vsc1t
(R.O. 91888)



TARGHETTE POSTERIORI

REAR BADGE

14 272 0320



TARGHETTA POSTERIORE
NAMEPLATE REAR
(R.O. 121012)

14 272 0350



TARGHETTA POSTERIORE
NAMEPLATE REAR
(R.O. 151715)

14 272 0270



TARGHETTA POSTERIORE
NAMEPLATE REAR
(R.O. 90653)

Vespa Rally

Primavera

150 Sprint

14 272 0280



TARGHETTA POSTERIORE
NAMEPLATE REAR
(R.O. 121081)

14 272 0410



TARGHETTA POSTERIORE
NAMEPLATE REAR
(R.O. 151714)

14 272 0300



TARGHETTA POSTERIORE
NAMEPLATE REAR
(R.O. 90653)

150 Super

Grand Turismo

Vespa Sprint

14 272 0360



TARGHETTA POSTERIORE
NAMEPLATE REAR
(R.O. 126072)

14 272 0370



TARGHETTA POSTERIORE
NAMEPLATE REAR
(R.O. 100042)

14 272 0260



TARGHETTA POSTERIORE
NAMEPLATE REAR
(R.O. 150498)

Special

Super Sport

125 Super

14 272 0420



TARGHETTA POSTERIORE
NAMEPLATE REAR
(R.O. 120792)

14 272 0540



TARGHETTA POSTERIORE
NAMEPLATE REAR
PIAGGIO 50: Vespa 50 S • V5A1
(R.O. 152510)

14 272 0550



TARGHETTA POSTERIORE
NAMEPLATE REAR
PIAGGIO 50: Vespa Special V5B3T
(R.O. 152511)

Rally

vespa 50s

50 special

TARGHETTE POSTERIORI

REAR BADGE

**14 272 0560** **TARGHETTA POSTERIORE****NAMEPLATE REAR****PIAGGIO 125:** Vespa Gtr • VNL2T
(R.O. 152514)**125 g.t.r.****14 272 0570** **TARGHETTA POSTERIORE****NAMEPLATE REAR****PIAGGIO: 200:** Vespa Rally • VSE1T
(R.O. 152515)**rally 200****14 272 0580** **TARGHETTA POSTERIORE****NAMEPLATE REAR****PIAGGIO125:** Vespa Et3 • VMB1
(R.O. 158562)**ET3****14 272 0530** **TARGHETTA POSTERIORE****REAR NAMEPLATE****PIAGGIO 50:** Vespa • V5A1
(R.O. 152509)**vespa 50****14 272 0950** **TARGHETTA POSTERIORE****REAR NAMEPLATE****PIAGGIO 125:** Vespa Primavera • VMA2
(R.O. 145340)**125 primavera****14 272 1020** **TARGHETTA POSTERIORE****REAR NAMEPLATE****PIAGGIO 125:** Vespa Ts • VNL3T
(R.O. 156202)**125 t.s.****14 272 0510** **TARGHETTA POSTERIORE****REAR NAMEPLATE****PIAGGIO 90:** Vespa • V9A1
(R.O. 145341)**vespa 90****14 272 0960** **TARGHETTA POSTERIORE****REAR NAMEPLATE****PIAGGIO 150:** Vespa Sprint Veloce • VLB1T
(R.O. 145342)**150 sprint v.****14 272 0970** **TARGHETTA POSTERIORE****REAR NAMEPLATE****PIAGGIO 50:** Vespa Elestart • V5B4T
(R.O. 152512)**50 elestart**



TARGHETTE ADESIVE
LABELS

14 272 0470 

ETICHETTA MISCELA 2%
LABEL
10 pezzi - 10 pcs
(R.O. 610054M003)



14 272 0480 

ETICHETTA MISCELA 2%
LABEL
10 pezzi - 10 pcs
(R.O. 610054M00R)



14 272 0490 

ETICHETTA MISCELA 5%
LABEL
10 pezzi - 10 pcs
(R.O. 61 0054M001)



14 272 1030 

ETICHETTA RODAGGIO ROSSA
RUNNING RED LABEL
Vespa Gs 150
10 pezzi - 10 pcs
(R.O. 610292M)



14 272 1040 

ETICHETTA RODAGGIO ROSSA
RUNNING RED LABEL
Vespa Rally 180
10 pezzi - 10 pcs
(R.O. 610170M)



14 272 1050 

ETICHETTA RODAGGIO ROSSA
RUNNING RED LABEL
Vespa 50-90
10 pezzi - 10 pcs
(R.O. 610170M002)



14 272 1060 

ETICHETTA RODAGGIO BLU
RUNNING BLUE LABEL
Vespa Rally 180
10 pezzi - 10 pcs
(R.O. 610170M001)



14 272 1070 

ETICHETTA RODAGGIO BLU
RUNNING BLUE LABEL
Vespa 50-90
10 pezzi - 10 pcs
(R.O. 610170M003)



14 272 1080 

ETICHETTA BENZINA
FUEL - LABEL

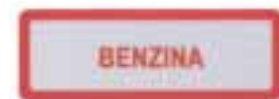

14 272 1230 

TARGHETTA NON OSTRUIRE IL FORO ROSSA
RED LABEL
4 pezzi - 4 pcs
(R.O. 610176M)



14 272 1240 

TARGHETTA NON OSTRUIRE IL FORO BLU
BLU LABEL
4 pezzi - 4 pcs
(R.O. 610176M0001)





14 272 0150 

TARGHETTA PER COFANO LATERALE
NAMEPLATE FOR SIDE PANEL
(R.O. 577081)

14 272 0190 

TARGHETTA PER COFANO LATERALE
NAMEPLATE FOR SIDE PANEL
(R.O. 575795)

14 272 0200 

TARGHETTA PER COFANO LATERALE
NAMEPLATE FOR SIDE PANEL
(R.O. 575796)



PX125

PX150

14 272 0460 

TARGHETTA PER COFANO LATERALE
NAMEPLATE FOR SIDE PANEL
PIAGGIO 150: Vespa Px 11
(R.O. 656220)

14 272 0600 

TARGHETTA COFANO LATERALE
NAME PLATE FOR SIDE PANEL
PIAGGIO 200: Vespa Pe • VSX
(R.O. 181328)

14 272 0610 

TARGHETTA PER COFANO LATERALE
NAMEPLATE FOR SIDE PANEL
PIAGGIO 150: Vespa Px • VLX
(R.O. 182117)



P200E

P150X

14 272 0620 

TARGHETTA PER COFANO LATERALE
NAMEPLATE FOR SIDE PANEL
PIAGGIO 125: Vespa Px E • VNX
(R.O. 194717)

14 272 0630 

TARGHETTA PER COFANO LATERALE
NAMEPLATE FOR SIDE PANEL
PIAGGIO 150: Vespa Px E • VLX
(R.O. 194718)

14 272 0670 

TARGHETTA - NAME PLATE
PIAGGIO 125: Vespa Pk S • Vmx1T
(R.O. 195635)

PX125E

PX150E

PK 125 S

14 272 0680 

TARGHETTA PER COFANO LATERALE
NAMEPLATE FOR SIDE PANEL
PIAGGIO 200: Vespa Px E • VSX
(R.O. 195641)

14 272 0660 

TARGHETTA COFANO LATERALE
NAME PLATE FOR SIDE PANEL
PIAGGIO 125: Vespa Pk • VMX1T
(R.O. 195634)

14 272 0690 

TARGHETTA COFANO LATERALE
NAME PLATE FOR SIDE PANEL
PIAGGIO 50: Vespa Elestart • V5B2T
(R.O. 196459)

PX200E

PK 125

elestart



TARGHETTE LATERALI

SIDE PANEL BADGE

14 272 0700



TARGHETTA - NAME PLATE

PIAGGIO 125: Vespa Px E Elestart • VNX2
(R.O. 198179)



14 272 0710



**TARGHETTA COFANO LATERALE
NAMEPLATE FOR SIDE PANEL**

PIAGGIO 125: Vespa Px E Arcobaleno • VNX2
(R.O. 198181)



14 272 0720



TARGHETTA - NAME PLATE

PIAGGIO 155: Vespa Pv E Arcobaleno • VLX2
(R.O. 198182)



14 272 0730



**TARGHETTA PER COFANO LATERALE
NAMEPLATE FOR SIDE PANEL**

PIAGGIO 200: Vespa Px E Arcobleno • VSX2
(R.O. 198183)



14 272 0740



**TARGHETTA PER COFANO LATERALE
NAMEPLATE FOR SIDE PANEL**

PIAGGIO: Vespa T5 • VNX5T
(R.O. 241316)



14 272 0750



**TARGHETTA COFANO LATERALE
NAME PLATE FOR SIDE PANEL**

PIAGGIO 125-150-200: Cosa • VLR1T • VLR • VSR1
(R.O. 254293)



14 272 0760



**TARGHETTA PER COFANO LATERALE
NAMEPLATE FOR SIDE PANEL**

PIAGGIO 50: Vespa N • V5A1T
(R.O. 256452)



14 272 0780



**TARGHETTA PER COFANO LATERALE
NAMEPLATE FOR SIDE PANEL**

PIAGGIO 80: Vespa Px E • V8X5T
(R.O. 198180)



14 272 0940



**TARGHETTA COFANO LATERALE
NAME PLATE FOR SIDE PANEL**

INNOCENTI 125-150-200: Lambretta Li 3° serie
(R.O. 19955051)



14 272 0590



**TARGHETTA COFANO LATERALE
NAME PLATE FOR SIDE PANEL**

PIAGGIO 125: Vespa Px • VNX
(R.O. 181327)



14 272 0650



**TARGHETTA COFANO LATERALE
NAME PLATE FOR SIDE PANEL**

PIAGGIO 50: Vespa Pk S • V5X1T
(R.O. 195631)



14 272 0770



**TARGHETTA COFANO LATERALE
NAME PLATE FOR SIDE PANEL**

PIAGGIO 150: Vespa P S • VBX
(R.O. 182895)





14 272 0790 

TARGHETTA COFANO LATERALE
NAME PLATE FOR SIDE PANEL

PIAGGIO 150: Vespa Px E Elestart • VLX2
(R.O. 198657)



14 272 0800 

TARGHETTA COFANO LATERALE
NAME PLATE FOR SIDE PANEL

PIAGGIO 200: Vespa Px E Elestart • VSX2
(R.O. 198658)



14 272 0990 

TARGHETTA COFANO LATERALE
NAME PLATE FOR SIDE PANEL

PIAGGIO 50: Vespa Pk • V5X1T
(R.O. 195630)



14 272 1000 

TARGHETTA COFANO LATERALE
NAME PLATE FOR SIDE PANEL

PIAGGIO 80: Vespa Pk S Elestart • V5X2T
(R.O. 198199)



14 272 1140 

TARGHETTA COFANO LATERALE
NAME PLATE FOR SIDE PANEL

PIAGGIO 125: Vespa Px E • Lusso
(R.O. 199362)



14 272 1150 

TARGHETTA COFANO LATERALE
NAME PLATE FOR SIDE PANEL

PIAGGIO 150: Vespa Px E Lusso
(R.O. 199363)



14 272 1180 

TARGHETTA COFANO LATERALE
NAME PLATE FOR SIDE PANEL

PIAGGIO 200: Vespa Px E Elestart Lusso
(R.O. 199366)



14 272 1010 

TARGHETTA COFANO LATERALE
NAME PLATE FOR SIDE PANEL

PIAGGIO 100: Vespa Pk S Elestart • V9X1T
(R.O. 198201)



14 272 1110 

TARGHETTA COFANO LATERALE
NAME PLATE FOR SIDE PANEL

PIAGGIO 125-150: Vespa Px Mod. 11
(R.O. 656219)



14 272 1120 

TARGHETTA COFANO LATERALE
NAME PLATE FOR SIDE PANEL

PIAGGIO 200: Vespa Px 98-11 • VSX1T
(R.O. 575797)



14 272 1130 

TARGHETTA COFANO LATERALE
NAME PLATE FOR SIDE PANEL

PIAGGIO 80: Vespa Px E Lusso
(R.O. 199361)



14 272 1160 

TARGHETTA COFANO LATERALE
NAME PLATE FOR SIDE PANEL

PIAGGIO 200: Vespa Px E Lusso
(R.O. 199364)





TARGHETTE LATERALI

SIDE PANEL BADGE

14 272 1170



TARGHETTA COFANO LATERALE

NAME PLATE FOR SIDE PANEL

PIAGGIO 80: Vespa Px E Elestart Lusso
(R.O. 199365)



14 272 1210



TARGHETTA PER COFANO LATERALE

NAMEPLATE FOR SIDE PANEL

PIAGGIO 50: Vespa S 4T 4V • Vespa S 2T
125: Vespa Gts 4T ie Super • Vespa S 4T 3V ie
300: Vespa Gts Super Sport
(R.O. 672061)



14 272 1220



TARGHETTA PER COFANO LATERALE

NAMEPLATE FOR SIDE PANEL

PIAGGIO 50: Vespa Lx 2T Touring 10-13 •
Vespa Lx 2T 05-13 • Vespa Lx 4T 4V 10-13 •
Vespa Lx 4T 05-08
(R.O. 656221)



14 272 1250



TARGHETTA PER COFANO LATERALE NA-

MEPLATE FOR SIDE PANEL

PIAGGIO: Vespa Gs mercato tedesco
german model
(R.O. 226542)



14 272 1260



TARGHETTA - NAMEPLATE

PIAGGIO: Ciao
(R.O. 163966)



12 185 0010



MOLLETTA FISSAGGIO TARGHETTA

PLATE FIXING SPRING

PIAGGIO: Vespa tutti i tipi
(R.O. 008108)
(Conf. 100 pz.)





14 272 1090 

PIAGGIO 200: Vespa Rally • Vse
(R.O. 610193M)



14 272 1100 

PIAGGIO 125: Vespa Et3 • VMB
(R.O. 610194M)





RMS

YOUR BEST PARTNER

▶ BATTERIE

BATTERIES



PERCHÉ SCEGLIERE LI-ON BATTERY?

Lo speciale metodo costruttivo delle batterie **LI-ON** permette di avere una batteria con un rapporto prestazioni/volume.

Per facilitare il montaggio della batteria senza intervenire sul cablaggio elettrico o creare problemi di corretto alloggiamento e fissaggio, le batterie **LI-ON** sono dotate di appositi distanziali modulari che consentono di raggiungere le dimensioni della batteria standard che si sostituisce.

Ciò permette prestazioni eccezionali, peso contenuto e facile installazione evitando soluzioni approssimative di fissaggio e di realizzazione come nel caso di batterie al litio oggi in commercio.

Le batterie **LI-ON** garantiscono una notevole versatilità per applicazioni sia racing che custom e possono essere ricaricate usando l'apposito caricabatterie **LI-ON**.

WHY CHOOSE LI-ON BATTERY?

*The special construction method of **LI-ON** allows you to have a battery with an excellent performance /volume and high versatility. It's very easy to assembly*

LI-ON batteries.

*Without changing the electrical wiring system or create problems for proper housing, the **LI-ON** batteries are equipped with special modular spacers which allow to reach the same dimensions as the standard battery that you are replacing.*

This means exceptional performances, low weight and easy installation avoiding imprecise solutions for fixing and construction as in the case of lithium batteries today on the market.

LI-ON provide considerable versatility for both racing and custom applications and can be recharged with dedicated charger by **LI-ON**.

DISTANZIALI MODULARI / MODULAR SPACERS

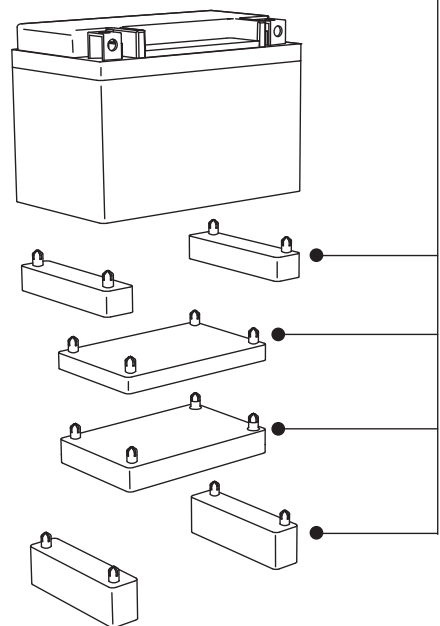

Indicatore di carica della batteria
Battery Charge Indicator



Più leggere delle batterie convenzionali al piombo-acido
Lighter than LEAD-ACID batteries



Capacità di Ricarica
Charging Capability













Cicli di Ricarica
Charging Cycles

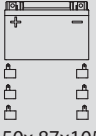

LiFePO₄ TECHNOLOGY

MODELLO MODEL	SOSTITUISCE CAN REPLACE	DIMENSIONI POLI DIMENSIONS TERMINAL (mm)	Distanziali Modulari MODULAR SPACERS (mm)	PESO WEIGHT (Kg)	CORRENTE DI CARICA CHARGE CURRENT (AMP)		SPUNTO CRANKING (CCAMP) TESTED BY ARGUS (AA500P)	BARCODE
					STD	MAX		
LTZ55 24 664 0010 	YTZ55 YTX4L-BS YTX5L-BS	 113x70x85	100x50x10 (2 pz - 2 pcs)	0,5	1	10	120	
LTZ75 24 664 0020 	YTZ75 YTX7L-BS	 113x70x85	100x50x10 (1 pz - 1 pcs) 100x50x15 (3 pz - 3 pcs)	0,6	1	12	150	
LTZ10S 24 664 0030 	YTZ10S	 150x87x93		0,9	2	20	240	
LTZ14S 24 664 0040 	YTZ12S YTZ14S	 150x87x93	86x20x17 (2 pz - 2 pcs)	1,1	2	22	290	
LT9B 24 664 0050 	YT7B-BS YT9B-BS	 150x65x92	64x20x13 (2 pz - 2 pcs)	0,7	1,5	15	190	
LT12B 24 664 0060 	YT12B-BS YT14B-BS YB16AL-A2	 150x65x92	64x20x13 (2 pz - 2 pcs) 64x19x38 (2 pz - 2 pcs)	1,1	2,5	24	290	
LTX9 24 664 0070 	YTX9-BS YTR9-BS	 150x87x105		0,7	1,5	15	180	
LTX12 24 664 0080 	YTX12-BS YTX12A-BS YB12B-B2	 150x87x93	100x50x10 (1 pz - 1 pcs) 86x20x17 (4 pz - 4 pcs)	0,9	2	18	210	

MODELLO MODEL	SOSTITUISCE CAN REPLACE	DIMENSIONI POLI DIMENSIONS TERMINAL (mm)	DISTANZIALI MODULARI MODULAR SPACERS (mm)	PESO WEIGHT (Kg)	CORRENTE DI CARICA CHARGE CURRENT (AMP)		SPUNTO CRANKING (CCAMP) TESTED BY ARGUS (AA500P)	BARCODE
					STD	MAX		
LTX14 24 664 0120 	YTX14H-BS KMX14-BS YTX14-BS HVT-8	 150x87x93	86x20x25 (4 pz - 4 pcs)	1,1	2	20	240	
LTX20H-Q 24 664 0090 	GYZ20H(L) YTX20H(L)-BS YTX20(L)-BS YB16-B-CX (S) YB16(L)-B YB18(L)-A(2) Y50-N18A-A GYZ20(L) YTX24H(L)-BS YTX15(L)-BS YTX18(L)-BS YB16H(L)-A-CX Y50-N18(L)-A-CX	 175x87x130	86x20x25 (2 pz - 2 pcs) 100x50x10 (1 pz - 1 pcs) 100x50x15 (2 pz - 2 pcs)	1,7	3,5	28	420	
LTX20CH 24 664 0100 	YTX16-BS YTX20CH-BS YB16B-A GYZ16H	 150x 87x105	86x20x17 (1 pz - 1 pcs) 86x21x25 (2 pz - 2 pcs)	1,4	3,5	28	360	
L51913 24 664 0110 	51814 51913 52015	 185x81x170		1,7	3,5	28	450	

24 670 0110 

CARICATORE - MANTENITORE PER BATTERIE AL LITIO
LITHIUM BATTERY CHARGER - MAINTAINER

- Corrente di carica - *Output current 2A*
- Adatto per batterie fino a 50 Ah - *Up to 50 Ah*
- Protezione da corto circuito - *Short circuit protection*
- Protezione contro inversione di polarità - *Polarity reverse protection*
- Protezione da sovraccarico - *Over charge protection*



BATTERIE LION R

BATTERIE AL LITIO RACING

La linea di batterie al litio **LION** si arricchisce della nuova linea **R**.

Le batterie **LION R** si contraddistinguono per la capacità di unire ad un formidabile spunto per l'avviamento dimensioni estremamente ridotte.

Ciò permette il loro posizionamento in modo facile su moto da cross, enduro, sportive racing, moto custom ed in ogni situazione dove si necessita di una batteria performante, di peso estremamente ridotto, con dimensioni ed un'autoscarica ridottissime.

Le batterie **LION R**, per via delle caratteristiche/dimensioni/spunto riescono a coprire, con solo 2 modelli, una gamma di batterie al piombo/acido che va da 5 Ah a 24 Ah con peso e dimensioni minime.

La linea **R** viene inoltre completata da un caricabatteria/mantenitore di carica professionale appositamente studiato per tenere sempre in ottimo stato le batterie **LION R**.

LION R BATTERY

RACING LITHIUM BATTERY





LION Lithium Batteries Line is enhanced of **R** version.

LION R batteries are characterized by a big cranking power and compact dimensions, that allows their placement in a easy way on motocross, offroad, supersport, custom bikes, and in any situation where needs a powerful battery, very low weight, small dimensions and with a very low selfdischarge.

R line is also completed by a battery charger/maintainer professionally designed to keep **LION R** batteries in good condition.

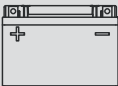
The **R** line is also complemented by a battery charger / maintainer upload professionally designed to keep the batteries in optimum state **LION R**

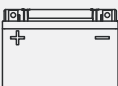

MODELLO MODEL	SOSTITUISCE CAN REPLACE	DIMENSIONI POLI DIMENSIONS TERMINAL (mm)	PESO WEIGHT (Kg)	CORRENTE DI CARICA CHARGE CURRENT (AMP)	SPUNTO CRANKING (CCAMP) TESTED BY ARGUS (AA500P)	BARCODE
				MAX		
LTR14 24 664 0130 	Batterie al piombo /acido da 5 a 14 Ah <i>Lead / acid batteries from 5 to 14 Ah</i>	 113x 58x86	0,9	14	210	
LTR24 24 664 0140 	Batterie al piombo /acido da 9 a 24 Ah <i>Lead / acid batteries from 9 to 24 Ah</i>	 148x82x135	1,4	24	360	

24 670 0130



CARICATORE - MANTENITORE PER BATTERIE AL LITIO
LITHIUM BATTERY CHARGER - MAINTAINER

- Corrente di carica 1-3 A - *Output current 1-3 A*
- Voltaggio 6-12 V - *Voltage 6-12 V*
- Protezione da corto circuito - *Short circuit protection*
- Protezione contro inversione di polarità - *Polarity reverse protection*
- Protezione da sovraccarico - *Over charge protection*



Hanno già scelto Li-On Battery:



Fornitore ufficiale



Yamaha World Endurance Official Team
French SBK Championship Team



Tourist Trophy STK 1000 - SBK 1000 - Senior TT
Road Racing SS 600

NUOVA LINEA BATTERIE PRE-ATTIVATE

SLA
FACTORY ACTIVATED
Ready to start!



CODICE	DESCRIZIONE	BARCODE	CODICE	DESCRIZIONE	BARCODE
24 665 0015	Batteria BIX30L		24 665 0265	Batteria BT4B-5	
24 665 0025	Batteria BCP18-12		24 665 0275	Batteria BTX14AH	
24 665 0035	Batteria BTZ7S		24 665 0285	Batteria BB14L-A2	
24 665 0045	Batteria BTZ10S		24 665 0295	Batteria BTX14L	
24 665 0055	Batteria BTZ12S		24 665 0305	Batteria BTX16	
24 665 0065	Batteria BTZ14S		24 665 0315	Batteria BTX20CH	
24 665 0075	Batteria BT7B-4		24 665 0325	Batteria BTX20HL	
24 665 0085	Batteria BT9B-4		24 665 0335	Batteria BTX24HL	
24 665 0095	Batteria BT12B-4		24 665 0345	Batteria BB16CL-B	
24 665 0105	Batteria BT14B-4		24 665 0355	Batteria BTZ5S	
24 665 0115	Batteria BB4L-B		24 665 0365	Batteria BTZ6S	
24 665 0125	Batteria BTR4A-5		24 665 0375	Batteria B50N18L-A	
24 665 0135	Batteria BTX4L		24 665 0385	Batteria BB10L-A2	
24 665 0145	Batteria BTX5L		24 665 0395	Batteria BB14L-B2	
24 665 0155	Batteria BB5L-B		24 665 0405	Batteria BB7L-B2	
24 665 0165	Batteria BTX7A		24 665 0415	Batteria BB12AL-A2	
24 665 0175	Batteria BTX7L		24 665 0425	Batteria BB14A-A2	
24 665 0185	Batteria BTX9		24 665 0435	Batteria BB16AL-A2	
24 665 0195	Batteria BB9-B		24 665 0445	Batteria 12N5.5-3B	
24 665 0205	Batteria BB10L-B2		24 665 0455	Batteria 12N5.5-4A	
24 665 0215	Batteria BT12A		24 665 0465	Batteria BB3L-B	
24 665 0225	Batteria BTX12		24 665 0475	Batteria BB7C-A	
24 665 0235	Batteria BTX14		24 665 0535	Batteria BTZ8V	
24 665 0245	Batteria BTX20L		24 665 0545	Batteria 53030	

MODELLO BATTERIA BATTERY MODEL	CAPACITÀ CAPACITY AH (10HR)	CCA A (-18°C)	DIMENSIONI DIMENSION			LAYOUT	TERMINALE TERMINAL	CODICE RMS RMS CODE	BARCODE
			mm (±2mm)						
			L	W	H				
BATTERIE STANDARD - STANDARD BATTERIES									
BB4L-B Con Acido a corredo With electrolyte	4	56	120	70	92		A	24 660 0065	
BB5L-B Con Acido a corredo With electrolyte	5	65	120	60	130		B	24 660 0085	
12N5.5-3B Con Acido a corredo With electrolyte	5,5	44	135	60	130		B	24 660 0295	
BB7-A Con Acido a corredo With electrolyte	8	124	135	75	133		B	24 660 0135	
BB7L-B2 Con Acido a corredo With electrolyte	8	124	135	75	133		A	24 660 0285	
BB9-B Con Acido a corredo With electrolyte	9	130	135	75	139		B	24 660 0155	
BB10L-A2 Con Acido a corredo With electrolyte	11	160	135	90	145		D	24 660 0445	
BB10L-BP Con Acido a corredo With electrolyte	11	165	135	90	145		B	24 660 0185	
BB10L-B2 Con Acido a corredo With electrolyte	11	160	135	90	145		D	24 660 0195	
BB12AL-A Con Acido a corredo With electrolyte	12	165	134	80	160		B	24 660 0255	
BB12AL-A2 Con Acido a corredo With electrolyte	12	165	134	80	160		B	24 660 0275	
BB12A-B Con Acido a corredo With electrolyte	12	165	134	80	160		B	24 660 0455	
BB12A-A Con Acido a corredo With electrolyte	12	165	134	80	160		B	24 660 0715	
BB14L-A2 Con Acido a corredo With electrolyte	14	190	134	89	166		D	24 660 0435	
BB14-A2 Con Acido a corredo With electrolyte	14	190	134	89	166		D	24 660 0335	
BB16AL-A2 Con Acido a corredo With electrolyte	16	175	207	71,5	164		F	24 660 0385	
51913 Con Acido a corredo With electrolyte	19 (20Hr)	100	186	82	171		G	24 660 0755	
B60-N30L-A (53030) Con Acido a corredo With electrolyte	30	300	184	130	170		G	24 660 0745	

TERMINAL TYPE	A	B	D	F	G
3D DRAWING					

MODELLO BATTERIA BATTERY MODEL	CAPACITÀ CAPACITY AH (10HR)	CCA A (-18°C)	DIMENSIONI DIMENSION			LAYOUT	TERMINALE TERMINAL	CODICE RMS RMS CODE	BARCODE
			mm (±2mm)						
			L	W	H				
BATTERIE SIGILLATE - MAINTANCE FREE (Tutte fornite con acido a corredo - All supplied with electrolyte)									
BTX4L-BS	3	50	113	70	85		A	24 661 0025	
BTX5L-BS	4	70	113	70	105		A	24 661 0045	
BTX7L-BS	6	85	113	70	130		A	24 661 0065	
BTX7A-BS	6	90	150	87	93		A	24 661 0055	
BTZ7S-BS	6	130	113	70	105		A	24 661 0195	
BT7B-BS	6,5	85	150	65	93		A	24 661 0155	
BTX9-BS	8	120	150	87	105		A	24 661 0095	
BT9B-BS	8	115	150	68	105		A	24 661 0165	
BTZ10S-BS	8,5	190	150	88	91		A	24 661 0175	
BT9A-BS	9	120	135	75	139		A	24 661 0105	
BTX12-BS	10	180	150	87	130		A	24 661 0115	
BT12A-BS	10	175	150	88	105		A	24 661 0225	
BT12B-BS	10	175	150	69	130		A	24 661 0125	
BTZ12S-BS	11	210	150	88	110		A	24 661 0185	
BTZ14S-BS	11,2	230	150	88	110		A	24 661 0215	
BTX14-BS	12	200	150	87	145		A	24 661 0135	
BTX14L-BS	12	200	150	87	145		A	24 661 0205	
BTX16-BS	14	230	150	87	161		A	24 661 0145	
BTX20L-BS	18	270	175	87	155		A	24 661 0075	
BTX20HL-BS	18	310	175	87	155		A	24 661 0255	

TERMINAL TYPE	A	B	D	F	G
3D DRAWING					

24 665 0485

BATTERIA SLA - MAX BTX14HL (GEL)
 Specifica per modelli Harley Davidson

24 665 0495

BATTERIA SLA - MAX BTX20HL (GEL)
 Specifica per modelli Harley Davidson

24 665 0505

BATTERIA SLA - MAX BIX30HL (GEL)
 Specifica per modelli Harley Davidson

24 665 0515

BATTERIA SLA - MAX 51913
 Specifica per modelli Bmw

24 665 0525

BATTERIA SLA - MAX BTX14H
 Specifica per modelli Bmw

TIPO DI BATTERIA BS	CAPACITA' AH (10HR)	CCA A(-18°C)	DIMENSIONI mm (±2 mm)			LAYOUT	TERMINALE
			L	W	H		
24 665 0485	14	350	149	87	144		
24 665 0495	20	460	176	87	154		
24 665 0505	30	530	166	130	175*		
24 665 0515	21 (20Hr)	210	182	77	168		
24 665 0525	14	220	150	87	145		

* Disponibile con un distanziale alla base portando l'altezza a 197 mm.



• I terminali sono specificatamente disegnati per facilitare il montaggio sulle Harley Davidson.



• Speciale struttura esterna per una massima resistenza alle vibrazioni.



• La BTX20HL e la BIX30HL, terminali specifici Harley Davidson.

• BTX14HL, terminali specifici Harley Davidson.

24 670 0010 

BA10 - CARICABATTERIE AUTOMATICO

- 6V/12V - 1000mA
- Caricabatterie e mantentore di carica
- 3 livelli di carica controllata
- Protezione contro il corto circuito
- Selezione tensione di uscita a 6V/12V



24 670 0090 

BS15 - CARICABATTERIE AUTOMATICO

- 12V 1500mA
- Caricatore e mantentore
- Funzione desolfatazione
- 8 fasi di ricarica: verifica dello stato della batteria, desolfatazione, carica di avviamento leggera, carica principale, carica di assorbimento, analisi della batteria, modalità alternata di mantenimento a lungo termine e ricarica
- Adatto per batterie fino a 30Ah
- Protezione contro il corto circuito, polarità invertita e sovraccarico
- Ideale per il mantenimento della batteria durante il periodo invernale
- Pinze in dotazione



24 670 0190 



BS60 - CARICABATTERIE AUTOMATICO

- Caricabatterie automatico ad 9 fasi
- 12V 1000mA / 4000mA / 6000mA
- Caricatore e mantentore
- Funzione desolfatazione
- 9 fasi di ricarica: verifica dello stato della batteria, desolfatazione, carica di avviamento leggera, carica principale, carica di assorbimento, analisi della batteria, livellamento della carica, modalità alternata di mantenimento a lungo termine e ricarica
- Adatto per batterie fino a 120Ah
- Protezione contro il corto circuito, polarità invertita e sovraccarico



24 670 0180 



JUMP STARTER BS PB-01 12A

- Tipo di batteria: Litio ferro 12V 44Wh
- Spunto 200A
- Spunto iniziale 400A
- Dimensioni (mm): 170x82x32
- Uscite: Usb 5V 2,1A / DC 12V 10A
- Peso 408 Gr.



	BA 10	BS 15	BS 60
TIPO:	AUTOMATIC	SMART	SMART
Corrente di alimentazione <i>Input range</i>	100-240 Vac	100-240 Vac	100-240 Vac
Frequenza <i>Frequency</i>	50/60 Hz	50/60 Hz	50/60 Hz
Corrente di carica <i>Output current</i>	1A	1,5A	1/4/6A
Adatto per batterie <i>Suitable for</i>	6V&12V	12V	12V
Funzione rinnovamento <i>Rejuvenation mode</i>	-	Si Yes	Si Yes
Funzione equalizzazione <i>Equalization mode</i>	-	Si Yes	Si Yes
Capacità (Ah) - <i>Capacity</i>			
- Carica - <i>Charging range</i>	2-40	4-30	3-120
- Mantenimento - <i>Maintenance</i>	2-60	4-120	3-180
Dimensioni mm <i>Dimensions</i>	100*65*36	149*71*32	182*88*48
Peso - <i>Weight</i>	0,4 Kg	0,45 Kg	0,75 Kg
Tipi batterie - <i>Battery types</i>	GEL, AGM, PIOMBO, CALCIO		

24 670 0100

BK10 - CARICABATTERIE PROFESSIONALE MULTIPLIO

- 12V - 1000mA x 10
- Caricabatterie e mantentore di carica fino a 10 batterie da 2 A a 40 A
- Tre livelli di controllo di carica
- Protezione interna di calore
- Regolato tramite microprocessore
- Pinze in dotazione ad alta resistenza di corrosione
- Protezione contro il corto circuito, polarità invertita e sovraccarico
- Dimensioni: 401x151x73
- Peso: 3,6 Kg.

24 670 0140

BK15 - CARICABATTERIE PROFESSIONALE MULTIPLIO

- 12V - 1500mA x 5
- Caricabatterie e mantentore di carica fino a 5 batterie da 2 A a 40 A
- Funzione di ricondizionamento delle piastre
- 8 Fasi di carica
- Protezione interna di calore
- Regolato tramite microprocessore
- Pinze in dotazione ad alta resistenza di corrosione
- Protezione contro il corto circuito, polarità invertita e sovraccarico

24 670 0040

BT01 - TESTER CARICA BATTERIA

- Mostra la condizione di carica della batteria al premere del pulsante

24 670 0050

BT02 - TESTER BATTERIA E ALTERNATORE

- Mostra la condizione di carica della batteria e verifica il corretto funzionamento dell'alternatore

24 670 0060

CONNETTORE ACCENDISIGARI

Adattabile a tutti i caricabatterie 6V-12V

24 670 0070

CONNESSIONE PERMANENTE PER CARICA BATTERIE E BATTERIE IN MODALITA' MANTENIMENTO

24 670 0200

CL-01 PINZE PER CARICABATTERIE

Compatibile con caricabatterie BS: BA09, BA10, BS15, BS20, BS40, BS60, BS80 & PA-03

24 670 0210

CL-02 PINZE PER CARICABATTERIE

Compatibile con caricabatterie BS: BA09, BA10, BS15, BS20, BS40, BS60, BS80 & PA-03





MODELLO BATTERIA BATTERY MODEL	V	A/h	SPUNTO A(EN) CRAN- CKING POWER	DIMENSIONI DIMENSIONS (mm)			PESO CON ACIDO WEIGHT WITH ELECTROLYTE	VOLUME ACIDO (L) ELECTROLYTE CAPACITY (L)	POLARITA' POLARITY	CODICE RMS RMS CODE	TERMINALE TERMINAL	BARCODE
				L	W	H						

BATTERIE STANDARD - STANDARD BATTERIES

YB4L-B Con Acido a corredo <i>With electrolyte</i>	12	4	50	121	71	93	1,5	0,30		24 660 0060	2	
YB9-B Con Acido a corredo <i>With electrolyte</i>	12	9	130	137	76	135	3,1	0,60		24 660 0150	3	
YB10L-BP Con Acido a corredo <i>With electrolyte</i>	12	11	160	135	90	145	5,0	0,81		24 660 0180	3	
YB12AL-A Con Acido a corredo <i>With electrolyte</i>	12	12	165	135	81	160	4,1	0,70		24 660 0250	3	
BB14L-A2 Con Acido a corredo <i>With electrolyte</i>	12	14	190	134	89	166	4,1	0,70		24 660 0300	5	

BATTERIE SIGILLATE (Tutte fornite con acido a corredo - MF Batteries with acid pack)

YTX4L-BS	12	3	50	110	67	86	1,7	0,27		24 661 0020	2	
YTX5L-BS	12	4	70	113	70	103	1,9	0,31		24 661 0040	2	
YTX7A-BS	12	6	80	152	88	94	2,4	0,38		24 661 0050	2	
YTX7L-BS	12	6	80	114	71	131	2,5	0,33		24 661 0060	2	
YTZ7S-BS	12	6	120	114	70	108	2,1	0,3		24 661 0190	5	
YT7B-BS	12	6,5	120	150	65	92	2,6	0,40		24 661 0150	5	
YTX9-BS	12	8	120	145	82	106	3,2	0,45		24 661 0090	2	
YT9B-BS	12	8	155	150	70	105	3,4	0,48		24 661 0160	5	
YTZ10S-BS	12	8,6	210	150	87	93	3,2	0,50		24 661 0170	5	
YTX9A-BS	12	9	140	137	76	136	3,2	0,57		24 661 0100	3	
YTX12-BS	12	10	180	149	86	131	4,0	0,60		24 661 0110	2	
YT12B-BS	12	10	160	152	70	131	4,5	0,50		24 661 0120	5	
YT12A-BS	12	10	180	150	87	106	3,2	0,54		24 661 0200	5	
YTZ12S-BS	12	11	210	150	87	110	3,7	0,62		24 661 0180	5	
YTZ14S-BS	12	11,2	230	150	87	110	3,9	0,64		24 661 0210	5	
YTX14-BS	12	12	200	149	86	147	4,5	0,69		24 661 0130	2	

TERMINALI - TERMINALS			TERMINALI - TERMINALS			TERMINALI - TERMINALS					
N°	FRONTALE FRONT	LATERALE LATERAL	SUPERIORE SUPERIOR	N°	FRONTALE FRONT	LATERALE LATERAL	SUPERIORE SUPERIOR	N°	FRONTALE FRONT	LATERALE LATERAL	SUPERIORE SUPERIOR
1				3				5			
2				4				6			

24 670 0160



CARICABATTERIE - MANTENITORE DI CARICA AUTOMATICO
AUTOMATIC BATTERY CHARGER AND MAINTAINER

- Corrente di carica - *Output current 900 mA*
- Voltaggio - *Voltage 6V / 12V*
- Completamente automatico - *Fully automatic*



24 670 0170



CARICABATTERIE - MANTENITORE DI CARICA AUTOMATICO
AUTOMATIC BATTERY CHARGER AND MAINTAINER

- Corrente di carica - *Output current 1,5 A*
- Voltaggio - *Voltage 12V*
- Completamente automatico - *Fully automatic*



24 670 0120



JUMP STARTER 8000-12V

- Tipo di batteria: *Litio ferro 12V 24Wh*
Battery type: Lithium iron 12V 24Wh
- Capacità nominale - *Nominal capacity 24Wh*
- Spunto - *Cranking 200A*
- Spunto iniziale - *Cranking peak 400A*
- Dimensioni (mm): - *Dimensions (mm): 192x100x40*
- Adattatore accendisigari incluso - *Cigarettes charger included*
- Uscite: - *Output: Usb 5V 2,1A / DC 12V 8A*
- Peso - *Weight 500 Gr.*



24 670 0150



JUMP STARTER 20000-12V

- Tipo di batteria: *Litio ferro 12V 60Wh*
Battery type: Lithium iron 12V 60Wh
- Capacità nominale - *Nominal capacity 60Wh*
- Spunto - *Cranking 500A*
- Spunto iniziale - *Cranking peak 1200A*
- Dimensioni (mm): - *Dimensions (mm): 223x140x72*
- Adattatore accendisigari incluso - *Cigarettes charger included*
- Uscite: - *Output: Usb 5V 2,1A / 5V 1A DC 12V 8A*
- Peso - *Weight 1400 Gr.*



▶ CANDELE
SPARK PLUGS





CANDELE SPARK-PLUGS

CODICE RMS RMS CODE	BARCODE	CODICE CHAMPION CHAMPION CODE	CODICE RMS RMS CODE	BARCODE	CODICE CHAMPION CHAMPION CODE
24 621 0100		OE037-L86C	24 621 0680		P-RG4HCC
24 621 0110		N9YC	24 621 0700		A59C
24 621 0120		CJ8	24 621 0710		C53CX
24 621 0130		L82C	24 621 0720		C55
24 621 0140		OE038/T10	24 621 0730		C55CX
24 621 0150		OE006/T10	24 621 0740		C55R
24 621 0180		RJ19LM	24 621 0750		C57
24 621 0200		L78C	24 621 0760		C61
24 621 0210		OE092-RG4HC	24 621 0770		C59R
24 621 0220		OE122-RG4PHP	24 621 0780		C63YC
24 621 0230		OE079-N4C	24 621 0790		G54V
24 621 0240		OE083-RA6HC	24 621 0810		G57C
24 621 0250		RG6YC	24 621 0820		G59C
24 621 0260		OE010-N7YC	24 621 0830		QA55V
24 621 0270		OE091-RN2C	24 621 0840		QC57
24 621 0280		OE073-RA4HC	24 621 0850		QC57C
24 621 0290		OE077-RC7BYC4	24 621 0860		QC59C
24 621 0300		RA8HC	24 621 0870		QC59YC
24 621 0310		RL78C	24 621 0880		QC61YC
24 621 0320		OE087-N6YC	24 621 0890		QL55
24 621 0330		OE042-RN12YC	24 621 0900		QN86
24 621 0340		OE074-N5C	24 621 0910		RG4YCX
24 621 0350		RA59GC	24 621 0920		OE103 - A59GC
24 621 0360		OE078-N3G	24 621 0930		OE112 - A6GC
24 621 0400		P-RZ7HC	24 621 0940		OE094 - RC6YCC
24 621 0430		RL82C	24 621 0960		OE023 - C9YCC
24 621 0590		N3C	24 621 0970		CJ6
24 621 0600		OE108-RN3C	24 621 0980		CJ7Y
24 621 0670		RN1C	24 621 1000		D14
			24 621 1020		D6

CODICE RMS RMS CODE	BARCODE	CODICE CHAMPION CHAMPION CODE	CODICE RMS RMS CODE	BARCODE	CODICE CHAMPION CHAMPION CODE
24 621 1030		D9	24 621 1360		RC7PYCBX
24 621 1040		DJ8J	24 621 1370		RC7YC3
24 621 1050		H8C	24 621 1380		OE014 - RC7YCC
24 621 1060		J12YC	24 621 1390		OE026 - RC8DMC
24 621 1070		J4C	24 621 1400		OE005 - RC9YC
24 621 1080		J8C	24 621 1410		OE039 - RC9YC4
24 621 1090		L77JC4	24 621 1420		RCJ6Y
24 621 1100		L78YC	24 621 1430		RCJ7Y
24 621 1120		OE007 - L87YC	24 621 1440		RCJ8Y
24 621 1130		L90C	24 621 1450		RD16
24 621 1140		OE059 - L92YC	24 621 1460		REA8MCX
24 621 1150		OE065 - N11YC	24 621 1470		OE031 - RES9YCC4
24 621 1160		OE015 - N12YC	24 621 1480		RF11YC
24 621 1180		OE084 - N6YCC	24 621 1500		RG6YCA
24 621 1190		OE012 - N7BYC	24 621 1510		RH10C
24 621 1210		OE022 - N9YCC	24 621 1520		RH12
24 621 1220		P7	24 621 1530		RH8C
24 621 1230		P8Y	24 621 1540		RJ12C
24 621 1240		P-RA7HC	24 621 1550		RJ18YC
24 621 1250		P-RG6HCC	24 621 1560		RJ6C
24 621 1260		P-RG7C	24 621 1570		OE064 - RL82YC
24 621 1270		P-RZ9HC	24 621 1580		RL86C
24 621 1280		QJ19LM	24 621 1590		RL87YC
24 621 1290		QL77JC4	24 621 1600		OE051 - RN11YC
24 621 1300		QN19V	24 621 1610		OE049 - RN11YC4
24 621 1310		RA2HC	24 621 1620		OE045 - RN11YCC
24 621 1320		OE052 - RA4HCX	24 621 1630		RN13LYC
24 621 1330		OE186 - RA8YCX4	24 621 1640		OE098 - RN4C
24 621 1340		OE013 - RC12YC	24 621 1650		RN57YCC
24 621 1350		RC14YC	24 621 1660		RN5C



CANDELE SPARK-PLUGS

CODICE RMS RMS CODE	BARCODE	CODICE CHAMPION CHAMPION CODE	CODICE RMS RMS CODE	BARCODE	CODICE CHAMPION CHAMPION CODE
24 621 1670		OE116 - RN6YC	24 621 1780		W14
24 621 1680		OE018 - RN7YC	24 621 1790		Z6
24 621 1690		OE008 - RN7YCC	24 621 1800		Z9Y
24 621 1710		OE048 - RN9YC4	24 621 1810		RG59V
24 621 1720		OE004 - RN9YCC	24 621 1820		RG4HCX
24 621 1730		RS14YC	24 621 1830		REA6YC
24 621 1740		RS14YC6			
24 621 1750		RV15YC4			
24 621 1760		RV17YC			
24 621 1770		UL81C			

CANDELE POWERSPORT™ - SPARK PLUGS POWERSPORT™

CODICE RMS CODE RMS	BARCODE	CODICE - CODE CHAMPION POWER SPORT	CODICE - CODE NGK IRIIDIUM	CODICE - CODE NGK	APPLICAZIONI APPLICATIONS
24 621 0460		8332-1	BPR7EIX	BPR7ES BP7ES	Moto Guzzi anni (years) 90 Bmw boxer anni (years) 70 Yamaha monocilindrici 4T, serie Xv-Xs (Single Cyl. 4 Stroke, Xv Xs Series)
24 621 0490		8415-1	BPR6EIX	BP5ES BP6ES BPR6ES BPR5ES	Bmw boxer anni (years) 80-90 Harley Davidson anni (years) 70-80 Moto Guzzi anni (years) 90-00 Yamaha serie Xs 1100 (Xs 1100 Series)
24 621 0420		8654-1	-	CR10E CR10EK	Benelli 900 Kawasaki Serie (Series) Z-Zx-Zrx-Zzr Mv Agusta 750-910 Piaggio Vespa G.T. 125 Suzuki Serie (Series) Gsf-Sv-Gsx R Triumph 675-800-955 Yamaha Serie (Series) Fz-Fzr-Fzs-Yzf
24 621 0500		8698-1	CR8EIX CR8EIX-9 CR7EIX CR9EIX-9	CR6E CR7E CR8EK CR9EK CR9E CR8EH-9 CR9EH-9	Scooter 4T (4 Stroke) Gruppo Piaggio Peugeot Suzuki Scooter-Serie (Series) Sv-DL-Gsx R Moto Guzzi Yamaha Scooter 4 T (4 Stroke), Serie (Series) Fjr-Wr 4T (4 Stroke)-Tmax Motori Kymco 4T raffreddati ad acqua (Kymco 4 Stroke water cooled engine) Kawasaki Serie (Series) Zx-Zzr-Er-Kx Honda Sh 125-150 Serie (Series) Cbr-Vfr-Transalp 90, Serie (Series) Silver Wing
24 621 0510		8809-1	DPR9EIX DR8EIX DR9EIX	D8EA D9EA DP8EA-9 DPR8EA-9 DPR9EA-9 DR7ES DR8EA DR9EA	Bmw Serie (Series) F-K 1100 1200 Buell Ducati 2V Aria (Air cooled) - 851-Serie (Series) 1000 Acqua (Water cooled) Harley Davidson Serie (Series) 883-1200 Honda Serie (Series) XL-Xr-Cbx 80-90 Cbr Vfr 90 Kawasaki Serie (Series) Gpz-Gpx-Er-KLE Ktm 450-520-625-1000 Suzuki Serie (Series) Gsx-Dr 125 250 Yamaha Serie (Series) Xt 250>600-Fz-Fzr
24 621 0520		8810-1	DCPR7EIX	DCPR6E DCPR7E DPR7EA-9 DCPR8E	Harley Davidson 883-1200-1584 Custom Giapponesi (Japanese Custom Bike) Ktm 450-525-640

CANDELE POWERSPORT™ - SPARK PLUGS POWERSPORT™

CODICE RMS CODE RMS	BARCODE	CODICE - CODE CHAMPION POWER SPORT	CODICE - CODE NGK IRIIDIUM	CODICE - CODE NGK	APPLICAZIONI APPLICATIONS
24 621 0410		8812-1	DPR7EIX-9	D6EA DP7EA-9 DPR6EA-9 DPR7EA-9	Bmw K75-K100 Harley Davidson 883-1450 Custom Giapponesi (Japanese Custom Bike) Kymco Scooter
24 621 0530		8814-1	BPR6HIX	BP6HS BP8HS BPR7HS BPR8HS	Aprilia Harley Davidson
24 621 0550		8902-1	BR8EIX	B8ES B9ES B10ES BR7ES BR8ES BR9ES	Moto Guzzi V75 Piaggio Vespa Pk 50-Cosa 125 200 Scooter gruppo Piaggio 50 2T (2 Stroke) Honda-Kawasaki-Yamaha 2T (2 Stroke)
24 621 0560		8904-1	BR9EIX BR8EIX	BR9EG BR8EG	Aprilia Rx-Rs 50 125 Cagiva 125 2T (2 Stroke) 90-00 Derbi Senda 50 Gilera 125 2T (2 Stroke) 80-90 Honda Ns-Nsr-Mtx 125 Moto Guzzi 650 750 Piaggio 2T (2 Stroke) 50>200 Husqvarna-Kawasaki-Ktm-Suzuki-Yamaha 2T (2 Stroke) Cross
24 621 0570		8018-1		BPR4FS BPR5FS	
24 621 0580		8071-1		BCPR7E BKR5E BKR5EVX	
24 621 0480		8405-1	BPR5EIX	BPR4ES BP5ESA	Harley Davidson 1340

DIMENSIONI CANDELE POWERSPORT - SPARK PLUGS DIMENSIONS

DIMENSIONI DIMENSIONS	CODICE RMS RMS CODE	MODELLO MODEL	A	B	C	D	TERMINALE TERMINAL
	24 621 0410	8812	12	19	18	0,8	3
	24 621 0420	8654	10	19	16	0,8	3
	24 621 0460	8332	14	19	21	0,7	2
	24 621 0470	8339	14	19	21	0,7	2
	24 621 0480	8405	14	19	21	1	2
	24 621 0490	8415	14	19	21	0,7	2
	24 621 0500	8698	10	19	16	0,8	3
	24 621 0510	8809	12	19	18	0,8	3
	24 621 0520	8810	12	19	16	1	2
	24 621 0530	8814	14	12	21	0,7	2
	24 621 0540	8883	14	12	21	0,7	2
	24 621 0550	8902	14	19	21	1	2
	24 621 0560	8904	14	19	21	0,7	2
	24 621 0570	8018	14	11,7	16	0,9	2
	24 621 0580	8071	14	19	16	0,9	2

24 633 0140

**CAPPUCCIO CANDELA 90° SENZA
RESISTORE, INNESTO TERMINALE SAE**
**90° SPARK PLUG BOOT WITHOUT RESISTOR,
SAE CONNECTION**
(Codice Champion PRO-0U)



24 633 0150

**CAPPUCCIO CANDELA 90° CON RESISTORE,
INNESTO TERMINALE M4**
**90° SPARK PLUG BOOT WITH RESISTOR,
M4 CONNECTION**
(Codice Champion PRO-5M)



24 633 0160

**CAPPUCCIO CANDELA 90° CON RESISTORE,
INNESTO TERMINALE SAE**
**90° SPARK PLUG BOOT WITH RESISTOR,
SAE CONNECTION**
(Codice Champion PRO-5U)



24 633 0170

**CAPPUCCIO CANDELA 180° CON RESISTORE,
INNESTO TERMINALE SAE**
**180° SPARK PLUG BOOT WITH RESISTOR,
SAE CONNECTION**
(Codice Champion SRO-5U)



24 621 0440

CANDELETTA DIESEL - DIESEL GLOW PLUG
PIAGGIO: Ape 0.5 D 83>
(Codice Champion CH260)



24 621 0450

CANDELETTA DIESEL - DIESEL GLOW PLUG
PIAGGIO: Porter 1.2 D 95>
(Codice Champion CH189)



CANDELE MOTORI MARINI - AGRICOLI
MARINE - AGRICULTURAL ENGINES SPARK PLUGS

CODICE RMS RMS CODE	BARCODE	CODICE CHAMPION CHAMPION CODE
24 621 0620		QC10PEPB
24 621 0630		QC10WEP
24 621 0640		QC8WEP
24 621 0650		QC12PEPB
24 621 0660		RS14PYP5
24 621 1850		3071
24 621 1860		3980
24 621 1870		8304-1/B01
24 621 1880		8401-1/B01
24 621 1890		8900-1/B01
24 621 1900		CJ14
24 621 1910		CJ4
24 621 1920		CJ6Y/W24
24 621 1930		CJ8Y
24 621 1940		D15Y/013
24 621 1950		D16
24 621 1960		D21/013
24 621 1970		D89D/014
24 621 1980		DJ6J
24 621 1990		DJ7J
24 621 2000		DJ7Y
24 621 2010		H10C
24 621 2020		H12
24 621 2030		J11C
24 621 2040		J17LM
24 621 2050		J17LM/W24
24 621 2060		J19LM
24 621 2070		J19LM/W24
24 621 2080		J6C
24 621 2090		K97F/014

CANDELE MOTORI MARINI - AGRICOLI
MARINE - AGRICULTURAL ENGINES SPARK PLUGS

CODICE RMS RMS CODE	BARCODE	CODICE CHAMPION CHAMPION CODE
24 621 2110		L6VC/110
24 621 2120		L76V/110
24 621 2130		L78V/110
24 621 2140		L78YC6/110
24 621 2150		L92LCC/012
24 621 2160		N19V
24 621 2170		OE011
24 621 2180		OE041
24 621 2190		OE148
24 621 2200		P10Y
24 621 2210		QC10PEP/013
24 621 2220		QC12GMC/161
24 621 2230		QC12PEP/161
24 621 2240		QC12YC
24 621 2250		QCJ6Y
24 621 2260		QCJ8Y
24 621 2270		QL16V/110
24 621 2280		QL6VC/110
24 621 2290		QL76V
24 621 2300		QL77CC/161
24 621 2310		QL77PP/013
24 621 2320		QL78C
24 621 2330		QL78V/110
24 621 2340		QL78YC/110
24 621 2350		QL78YC6/110
24 621 2360		QL82C/110
24 621 2370		QL82YC/110
24 621 2380		QL86C/110
24 621 2390		QL87YC/110
24 621 2400		RC12MC4/012

CANDELE MOTORI MARINI - AGRICOLI
MARINE - AGRICULTURAL ENGINES SPARK PLUGS

CODICE RMS <i>RMS CODE</i>	BARCODE	CODICE CHAMPION <i>CHAMPION CODE</i>
24 621 2410		RC9MC4/012
24 621 2420		RCJ4
24 621 2430		RCJ8
24 621 2440		RDJ6J
24 621 2450		RDJ7J
24 621 2460		RDJ7Y
24 621 2470		RDJ8J
24 621 2480		RDZ19H
24 621 2490		RDZ4H
24 621 2500		RF10C
24 621 2510		RF14YC/013
24 621 2520		RF9YC/012
24 621 2530		RH18Y
24 621 2540		RJ12YC
24 621 2550		RJ14YC
24 621 2560		RJ17LM
24 621 2570		RJ19LMC
24 621 2580		RJ88P
24 621 2590		RJ8C
24 621 2600		RL95YC
24 621 2610		RN14YC/012
24 621 2620		RN4YC
24 621 2630		RP10HC/110
24 621 2640		RS12PYP/013
24 621 2650		RS12YC/013
24 621 2660		RS15LYC/013
24 621 2670		RS17YX
24 621 2680		RV12C
24 621 2690		RV12YC/012
24 621 2700		RV8C

CANDELE MOTORI MARINI - AGRICOLI
MARINE - AGRICULTURAL ENGINES SPARK PLUGS

CODICE RMS <i>RMS CODE</i>	BARCODE	CODICE CHAMPION <i>CHAMPION CODE</i>
24 621 2710		RV91MC/110
24 621 2720		RV92YC
24 621 2730		RV9YC/012
24 621 2740		RY4C
24 621 2750		RZ7C
24 621 2760		RZF10
24 621 2770		UD16/013
24 621 2780		UJ11G/014
24 621 2790		UL18V
24 621 2800		UL77V
24 621 2810		UY6/014
24 621 2820		V57C-ST/003
24 621 2830		V63C-ST/003
24 621 2840		W10/014
24 621 2850		W16Y/014
24 621 2860		W18/014
24 621 2870		W20/014
24 621 2880		W89D/014
24 621 2890		XC10YC
24 621 2900		XC12PEPB/110
24 621 2910		XC12YC
24 621 2920		XC92YC
24 621 2930		XEJ8/014
24 621 2940		XEN14
24 621 2950		XMJ14/014
24 621 2960		XMJ17/014
24 621 2970		XMJ20/014
24 621 2980		Y82/014

CANDELE - CAPPUCCI CANDELE

SPARK PLUGS - SPARK PLUG CAP SET



CODICE RMS RMS CODE	BARCODE	CORRISPONDENZE COMPARISON CHART		APPLICAZIONE APPLICATION 	CARATTERISTICHE TECNICHE TECHNICAL SPECIFICATIONS		
		NYP50	NGK		Ø FIL. E ESAG. THREAD AND HEXAGON Ø (mm)	LUNGH. FILETTO THREAD LENGHT (mm)	ELETTRODO ELECTRODE
24 620 0101		N6DE1		MOTAZAPPA Cultivator	14 x 16	Corto - Short 7,7	Normale Normal

24 633 0010 

Motori Minarelli 50 cc
Innesto sulla candela ø 6,3
Spark plug cap ø 6,3



24 633 0030 

Motori F. Morini 50 cc



24 633 0050 

PIAGGIO: Ciao • Bravo • Boxer • Cba • Si •
Lambretta e applicazioni varie
(R.O.103936)



24 633 0020 

Motori Minarelli 50 Cc
Innesto sulla candela ø 4
Spark plug cap ø 4



24 633 0040 

Motori Raffreddamento ad acqua 50 cc
Water Cooling Engine 50 cc



12 183 0230 

PIAGGIO 50: Ape
50-125-150-200:
Vespa tutti i modelli - All models
(R.O. 244395)



24 633 0060 

In gomma speciale nera - Applicazioni varie
Special black rubber - Various applications



24 633 0070 

In gomma al silicone - Silicon rubber
Applicazioni varie - Various applications
(colore: rosso - blu - color: red - blue)



24 633 0080 

In gomma speciale nera - Applicazioni varie
Special black rubber - Various applications



12 183 0843 

PIAGGIO 150: Vespa Sprint • Sprint Veloce
VLA - VLB
(R.O. 46741)





CANDELE - CAPPUCCI CANDELE

SPARK PLUGS - SPARK PLUG CAP SET

24 633 0090



Kit cappuccio candela - *Spark plug cap set*
APRILIA 50: Ditech Iniezione



24 633 0100



In gomma al silicone - schermato
Tenuta d'acqua-Innesto cavo \varnothing 7
Innesto candela \varnothing 6,2
Applicazioni: Moto, Ciclomotori, da strada e fuoristrada
Sylicone rubber, shielded, \varnothing 7 cable connection, \varnothing 6,2 spark plug connections
Applications: Street and Offroad motorcycles and moped.



24 633 0110



In gomma al silicone - schermato
Tenuta d'acqua-Innesto cavo \varnothing 7
Innesto candela \varnothing 4-Ceramica candela \varnothing 10
Applicazioni: Moto, Ciclomotori, da strada e fuoristrada
Sylicone rubber, shielded, \varnothing 7 cable connection, \varnothing 4 spark plug connections, spark plug ceramic \varnothing 10
Applications: Street and Offroad motorcycles and moped.



24 633 0120



In gomma al silicone - schermato
Tenuta d'acqua-Innesto cavo \varnothing 7
Innesto candela \varnothing 6,2-Ceramica candela \varnothing 12
Applicazioni: Moto, Ciclomotori, da strada e fuoristrada
Sylicone rubber, shielded, \varnothing 7 cable connection, \varnothing 4 spark plug connections, spark plug ceramic \varnothing 12
Applications: Street and Offroad motorcycles and moped.



24 633 0130



In gomma al silicone - schermato
Tenuta d'acqua-Innesto cavo \varnothing 7
Innesto candela \varnothing 4-Ceramica candela \varnothing 12
Applicazioni: Moto, Ciclomotori, da strada e fuoristrada
Sylicone rubber, shielded, \varnothing 7 cable connection, \varnothing 4 spark plug connections, spark plug ceramic \varnothing 12
Applications: Street and Offroad motorcycles and moped.



24 649 0010



Cavo candela Vespa - Ciclomotori
Spark plug cable Vespa - Moped
Rotolo da 10 mt \varnothing mm 7
Packing 10/mtrs roll
(colore:nero - *black color*)



12 185 8470



12 185 8472

Attacco Candela a forcella Vespa
Spark Plugs Terminal Vespa
(Confezione 10 pz. - *10 pcs pack*)
(R.O. 127966)



12 183 0560



Cappuccio Candela - *Plug Device*
PIAGGIO: Si
(R.O. 213751)



12 185 9100



Terminale candela Sae avvitabile
Sae Spark plug terminal with thread
(Confezione 100 pz. - *100 pcs pack*)





24 648 0380 

COPPIA FRECCHE LED "DEMON" SILVER

- Alluminio Die Casting - Alloy Die Casting
- Luce Led - Led light
- Corpo Silver - Silver color
- **2 Pezzi - 2 pcs**

TRASPARENTE

E-MARK

LUCE LED

24 648 0381 

FRECCIA LED "DEMON" SILVER

- Alluminio Die Casting - Alloy Die Casting
- Luce Led - Led light
- Corpo Silver - Silver color
- **1 Pezzo - 1 pcs**

TRASPARENTE

E-MARK

LUCE LED

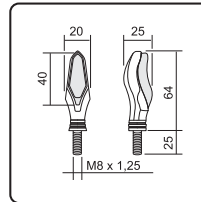

24 648 0390 

COPPIA FRECCHE LED "YAMATO" SILVER

- Alluminio Die Casting - Alloy Die Casting
- Luce Led - Led light
- Corpo Silver - Silver color
- **2 Pezzi - 2 pcs**

TRASPARENTE

E-MARK

LUCE LED

24 648 0391 

FRECCIA LED "YAMATO" SILVER

- Alluminio Die Casting - Alloy Die Casting
- Luce Led - Led light
- Corpo Silver - Silver color
- **1 Pezzo - 1 pcs**

TRASPARENTE

E-MARK

LUCE LED

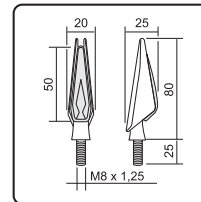

24 612 9020 

COPPIA RESISTENZE 25 W 8,2 Ω
COUPLE RESISTORS 25 W 8,2 Ω

- Con connettori - With connectors

24 612 9030 

RESISTENZA 50 W 7,5 Ω
RESISTOR 50 W 7,5 Ω

- Con connettori - With connectors





FRECCE MOTO
INDICATORS

24 648 0385



COPPIA FRECCHE LED "DEMON" NERO - BLACK

- Alluminio Die Casting - *Alloy Die Casting*
- Luce Led - *Led light*
- Corpo Nero - *Black color*
- **2 Pezzi - 2 pcs**

TRASPARENTE

E-MARK

LUCE LED

24 648 0386



FRECCIA LED "DEMON" NERO - BLACK

- Alluminio Die Casting - *Alloy Die Casting*
- Luce Led - *Led light*
- Corpo Nero - *Black color*
- **1 Pezzo - 1 pcs**

TRASPARENTE

E-MARK

LUCE LED

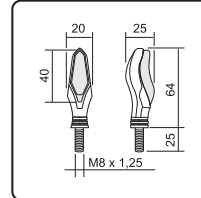

24 648 0395



COPPIA FRECCHE LED "YAMATO" NERO - BLACK

- Alluminio Die Casting - *Alloy Die Casting*
- Luce Led - *Led light*
- Corpo Nero - *Black color*
- **2 Pezzi - 2 pcs**

TRASPARENTE

E-MARK

LUCE LED

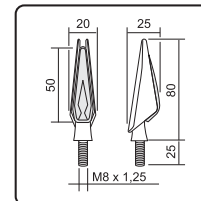



24 648 0275

**CP. FANALINI FRECCIA LED
LED INDICATOR COUPLE**

- Luce Led - Led light
- Corpo Nero - Black colour
- Coppia resistenze: 3W-27 Ω
Resistor couple: 3W-27 Ω

TRASPARENTE

E-MARK

LUCE LED



24 648 0280

**CP. FANALINI FRECCIA
INDICATOR COUPLE**

- Corpo Nero - Black colour
- Lampada 12 V.-21 W.
Bulb 12 V.-21 W.

ARANCIO

E-MARK



24 648 0211

**CP. FANALINI FRECCIA LED
LED INDICATOR COUPLE**

- Luce Led - Led light
- Corpo Nero - Black colour
- Coppia resistenze: 5W-31 Ω
Resistor couple: 5W-31 Ω
5W-31 Ω

TRASPARENTE

E-MARK

LUCE LED



24 648 0218

**CP. FANALINI FRECCIA LED
LED INDICATOR COUPLE**

- Luce Led - Led light
- Corpo Carbon - Carbon colour
- Coppia resistenze: 5W-31 Ω
Resistor couple: 5W-31 Ω
5W-31 Ω

TRASPARENTE

E-MARK

LUCE LED

CARBON LOOK



24 648 0221

**CP. FANALINI FRECCIA LED
LED INDICATOR COUPLE**

- Luce Led - Led light
- Corpo Nero - Black colour
- Coppia resistenze: 5W-31 Ω
Resistor couple: 5W-31 Ω
5W-31 Ω

TRASPARENTE

E-MARK

LUCE LED



24 648 0228

**CP. FANALINI FRECCIA LED
LED INDICATOR COUPLE**

- Luce Led - Led light
- Corpo Carbon - Carbon colour
- Coppia resistenze: 5W-31 Ω
Resistor couple: 5W-31 Ω

TRASPARENTE

E-MARK

LUCE LED

CARBON LOOK



24 648 0201

**CP. FANALINI FRECCIA LED
LED INDICATOR COUPLE**

- Luce Led - Led light
- Corpo Nero - Black colour
- Coppia resistenze: 5W-31 Ω
Resistor couple: 5W-31 Ω

TRASPARENTE

E-MARK

LUCE LED



24 648 0208

**CP. FANALINI FRECCIA LED
LED INDICATOR COUPLE**

- Luce Led - Led light
- Corpo Carbon - Carbon colour
- Coppia resistenze: 5W-31 Ω
Resistor couple: 5W-31 Ω

TRASPARENTE

E-MARK

LUCE LED

CARBON LOOK



24 648 0155

**CP. FANALINI FRECCIA LED
LED INDICATOR COUPLE**

- Luce Led - Led light
- Corpo Nero - Black colour
- Coppia resistenze: 5W-31 Ω
Resistor couple: 5W-31 Ω

TRASPARENTE

E-MARK

LUCE LED





FRECCE MOTO INDICATORS

24 648 0150 

**CP. FANALINI FRECCIA SLIM
LED INDICATOR COUPLE**

- Luce Led - *Led light*
- Lente trasparente ad incasso
Recessed clear lens
- Corpo Cromato - *Chrome colour*
- Packaging in blister
Blister packaging
- Coppia resistenze: 5W-31 Ω
Resistor couple: 5W-31 Ω



TRASPARENTE

E-MARK

LUCE LED

CROMATO

24 648 0160 

**CP. FANALINI FRECCIA SLIM
LED INDICATOR COUPLE**

- Luce Led - *Led light*
- Lente trasparente ovale ad incasso
Recessed oval clear lens
- Corpo Carbon - *Carbon colour*
- Packaging in blister
Blister packaging
- Coppia resistenze: 5W-31 Ω
Resistor couple: 5W-31 Ω



TRASPARENTE

E-MARK

LUCE LED

CARBON LOOK

24 648 0170 

**CP. FANALINI FRECCIA TRIANGOLARI
TRIANGULAR INDICATOR COUPLE**

- Luce Led - *Led light*
- Braccio lungo ammortizzato
Long arm suspension
- Lente esterna trasparente ad incasso
Recessed clear outer lens
- Corpo Carbon - *Carbon colour*
- Packaging in blister
Blister packaging
- Coppia resistenze: 5W-31 Ω
Resistor couple: 5W-31 Ω



TRASPARENTE

E-MARK

LUCE LED

CARBON LOOK

24 648 0140 

**CP. FANALINI FRECCIA TRIANGOLARI
TRIANGULAR INDICATOR COUPLE**

- Braccio lungo ammortizzato
Long arm suspension
- Corpo Carbon - *Carbon colour*
- Lente esterna trasparente
Recessed clear lens
- Lente interna arancio
Orange internal lens
- Lampada 12 V. - 21W.
Bulb 12 V. - 21W.
- Packaging in blister
Blister packaging



TRASPARENTE

E-MARK

CARBON LOOK

24 648 0020 

**CP. FANALINI FRECCIA
LED INDICATOR COUPLE**

- Lente triangolare ad incasso
Recessed triangular lens
- Braccio corto ammortizzato
Short arm suspension
- Corpo Carbon - *Carbon colour*
- Lente esterna trasparente
Recessed clear lens
- Lente interna arancio
Orange internal lens
- Lampada 12 V. - 21W.
Bulb 12 V. - 21W.
- Packaging in blister
Blister packaging



TRASPARENTE

E-MARK

CARBON LOOK

24 648 0010 

**CP. FANALINI FRECCIA
INDICATOR COUPLE**

- Braccio corto ammortizzato
Short arm suspension
- Corpo Carbon - *Carbon colour*
- Lente esterna arancio
Orange outer lens
- Lente triangolare ad incasso
Recessed triangular internal lens
- Lampada 12 V. - 21W.
Bulb 12 V. - 21W.
- Packaging in blister
Blister packaging



ARANCIO

E-MARK

CARBON LOOK

24 648 0060 

**CP. FANALINI FRECCIA
LED INDICATOR COUPLE**

- Lente ovale fissaggio a vite
Screw fixing oval lens
- Braccio corto - *Short arm*
- Corpo Carbon - *Carbon colour*
- Lente esterna trasparente
Recessed clear lens
- Lente interna arancio
Orange internal lens
- Lampada 12 V. - 21W.
Bulb 12 V. - 21W.
- Packaging in blister
Blister packaging



TRASPARENTE

CARBON LOOK

E-MARK

24 648 0070 

**CP. FANALINI FRECCIA SLIM
LED INDICATOR COUPLE**

- Lente arancio ovale ad incasso
Recessed orange oval lens
- Corpo Carbon - *Carbon colour*
- Packaging in blister
Blister packaging



ARANCIO

CARBON LOOK

Non omologate
per uso stradale

24 648 0080 

**CP. FANALINI FRECCIA SLIM
LED INDICATOR COUPLE**

- Lente trasparente ovale ad incasso
Recessed clear oval lens
- Corpo Carbon - *Carbon colour*



TRASPARENTE

CARBON LOOK

Non omologate
per uso stradale



24 648 0130 

CP. FANALINI FRECCIA TRIANGOLARI
TRIANGULAR INDICATOR COUPLE

- Braccio lungo ammortizzato
Long arm suspension
- Corpo nero - *Black colour*
- Lente esterna trasparente
Clear outer lens
- Lente interna arancio
Orange internal lens
- Lampada 12 V. - 21W.
Bulb 12 V. - 21W.
- Packaging in blister
Blister packaging



E-MARK

24 648 0090 

CP. FANALINI FRECCIA TRIANGOLARI
TRIANGULAR INDICATOR COUPLE

- Braccio corto ammortizzato
Short arm suspension
- Corpo nero - *Black colour*
- Lente esterna trasparente
Clear outer lens
- Lente interna arancio
Orange internal lens
- Lampada 12 V. - 21W.
Bulb 12 V. - 21W.
- Packaging in blister
Blister packaging



E-MARK

24 648 0100 

CP. FANALINI FRECCIA TRIANGOLARI
TRIANGULAR INDICATOR COUPLE

- Braccio corto ammortizzato
Short arm suspension
- Corpo cromato - *Chrome colour*
- Lente esterna trasparente
Clear outer lens
- Lente interna arancio
Orange internal lens
- Lampada 12 V. - 21W.
Bulb 12 V. - 21W.
- Packaging in blister
Blister packaging



E-MARK

24 648 0110 

CP. FANALINI FRECCIA OVALI
OVAL INDICATOR COUPLE

- Braccio corto ammortizzato
Short arm suspension
- Corpo nero - *Black colour*
- Lente esterna trasparente
Clear outer lens
- Lente interna arancio
Orange internal lens
- Lampada 12 V. - 21W.
Bulb 12 V. - 21W.
- Packaging in blister
Blister packaging



E-MARK

24 648 0120 

CP. FANALINI FRECCIA OVALI
OVAL INDICATOR COUPLE

- Braccio corto ammortizzato
Short arm suspension
- Corpo cromato - *Chrome colour*
- Lente esterna trasparente
Clear outer lens
- Lente interna arancio
Orange internal lens
- Lampada 12 V. - 21W.
Bulb 12 V. - 21W.
- Packaging in blister
Blister packaging



E-MARK



FRECCE MOTO
INDICATORS

FANALI FRECCIE COMPLETI - COMPLETE INDICATORS

24 648 0255



FANALE FRECCIA ANTERIORE DESTRO
(Lente trasparente)
FRONT INDICATOR RIGHT (Clear lens)
YAMAHA: T Max 500 01/07



24 648 0265



FANALE FRECCIA ANTERIORE SINISTRO
(Lente trasparente)
FRONT INDICATOR LEFT (Clear lens)
YAMAHA: T Max 500 01/07



24 648 0400



FRECCIA ANTERIORE DESTRA
(Lente arancione)
FRONT INDICATOR RIGHT
(Orange lens)
PIAGGIO: Vespa Px 125-150-200 • Px 125 T5
Px 125-150-200 Arcobaleno
(R.O. 163256)



24 648 0410



FRECCIA ANTERIORE SINISTRA
(Lente arancione)
FRONT INDICATOR LEFT
(Orange lens)
PIAGGIO: Vespa Px 125-150-200 • Px 125 T5
Px 125-150-200 Arcobaleno
(R.O. 162817)



24 648 0420



FRECCIA POSTERIORE DESTRA
(Lente arancione)
REAR INDICATOR RIGHT
(Orange lens)
PIAGGIO: Vespa Px 125-150-200 • Px 125 T5
Px 125-150-200 Arcobaleno
(R.O. 230339)



24 648 0430



FRECCIA POSTERIORE SINISTRA
(Lente arancione)
REAR INDICATOR LEFT
(Orange lens)
PIAGGIO: Vespa Px 125-150-200 • Px 125 T5
Px 125-150-200 Arcobaleno
(R.O. 230338)



24 648 0415



FRECCIA ANTERIORE SINISTRA
(Lente bianca)
FRONT INDICATOR LEFT
(White lens)
PIAGGIO: Vespa PX 125-150-200
PXE 125-150-200 - T5
VNX-VLX1-VSX-VNX5T
VNX2-VLX2-VSX2
(R.O. 583082)



24 648 0405



FRECCIA POSTERIORE DESTRA
(Lente bianca)
REAR INDICATOR RIGHT
(White lens)
PIAGGIO: Vespa PX 125-150-200
PXE 125-150-200 - T5
VNX-VLX1-VSX-VNX5T
VNX2-VLX2-VSX2
(R.O. 583083)



24 648 0435



FRECCIA ANTERIORE SINISTRA
(Lente bianca)
FRONT INDICATOR LEFT
(White lens)
PIAGGIO: Vespa PX 125-150-200
PXE 125-150-200 - T5
VNX-VLX1-VSX-VNX5T
VNX2-VLX2-VSX2
(R.O. 583084)



24 648 0425



FRECCIA POSTERIORE DESTRA
(Lente bianca)
REAR INDICATOR RIGHT
(White lens)
PIAGGIO: Vespa PX 125-150-200
PXE 125-150-200 - T5
VNX-VLX1-VSX-VNX5T
VNX2-VLX2-VSX2
(R.O. 583085)





24 647 0010 

E-MARK ARANCIO

24 647 0020 

E-MARK ARANCIO

24 647 0015 

TRASPARENTE

24 647 0025 

TRASPARENTE

ANTERIORE SINISTRA - LEFT FRONT

APRILIA: Sr 50 Stealth-Racing 97-99-Sr 125-150 99-01-Leonardo 125-150 96-98 (R.O. 8124544)



ANTERIORE DESTRA - RIGHT FRONT

APRILIA: Sr 50 Stealth Racing 97-99 Sr 125-150 99-01 Leonardo 125-150 96-98 (R.O. 8124543)



24 647 0145 

TRASPARENTE

24 647 0155 

TRASPARENTE

ANTERIORE SINISTRA - LEFT FRONT

APRILIA: Leonardo 125-150



ANTERIORE DESTRA - RIGHT FRONT

APRILIA: Leonardo 125-150



24 647 0030 

E-MARK ARANCIO

24 647 0180 

E-MARK ARANCIO

24 647 0035 

TRASPARENTE

24 647 0181 

ARANCIO

APRILIA:	Ant.Front	Post.Rear
Rally acqua 96 50	•	•
Rally aria 95-03 50		•
Scarabeo 2T 93-03 50	•	•
Scarabeo 2T 100	•	•
Sr acqua 97-00 50		•
Sr aria 97-01 50		•
Sr 97-01 125-150		•
Classic 125	•	•
Rs moto 99-03 50	•	•
Rs 98-03 250	•	•
Rsv 98-00 1000	•	•



24 647 0185 

TRASPARENTE

MBK 50:	Ant.Front	Post.Rear
Booster 90-94	•	
Booster Road 94-95	•	
Booster 01-03	•	
Booster Spirit 96-03	•	
Booster Spirit Eu 2 02-03	•	
Stunt 00-02	•	•

YAMAHA 50:	Ant.Front	Post.Rear
Bw's Original 97-02	•	
Bw's Original Eu 2 02-03	•	
Bw's R 01	•	
CWL Bw's 03	•	
Slider 00-02	•	•



24 647 0190 

E-MARK ARANCIO

24 647 0200 

E-MARK ARANCIO

24 647 0191 

ARANCIO

24 647 0201 

ARANCIO

24 647 0195 

TRASPARENTE

24 647 0205 

TRASPARENTE

POSTERIORE SINISTRA - LEFT REAR

MBK 50: Booster 01-03 - Spirit 99-03 Spirit Eu2 02-03 - Naked 03
YAMAHA 50: Bw's 03 - R 01-Original 99-02 Orig. Eu2 0203-Naked 03



POSTERIORE DESTRA - RIGHT REAR

MBK 50: Booster 01-03 - Spirit 99-03 Spirit Eu2 02-03 - Naked 03
YAMAHA 50: Bw's 03 - R 01-Original 99-02 Orig. Eu2 02-03-Naked 03



24 647 0210 

E-MARK ARANCIO

24 647 0220 

E-MARK ARANCIO

24 647 0215 

TRASPARENTE

24 647 0225 

TRASPARENTE

ANTERIORE SINISTRA - LEFT FRONT

MBK 50: Booster Ng 99-03 Booster Ng Eu1 99-00
YAMAHA 50 : Bw's Ng 99-03 Bw's Cat 99-00



ANTERIORE DESTRA - RIGHT FRONT

MBK 50: Booster Ng 99-03 Booster Ng Eu1 99-00
YAMAHA 50 : Bw's Ng 99-03 Bw's Cat 99-00



LENTI FRECCIA
INDICATOR LENSES

24 647 0040



E-MARK

ARANCIO

24 647 0050



E-MARK

ARANCIO

24 647 0045



TRASPARENTE

24 647 0055



TRASPARENTE

ANTERIORE DESTRA - SINISTRA
RIGHT/LEFT FRONT

MALAGUTI: F12 50 Phantom-Lc-win Disks 94-00
F12 50 Restyling-Lc-restyling Eu2 01-02
F12 100 Phantom 99-00
(R.O. 01903900)



POSTERIORE DESTRA - SINISTRA
RIGHT/LEFT REAR

MALAGUTI: F12 50-100-Phantom-Lc
Twin Disks Cat. 94-00-Crosser Cr1 50 95-98
Fifty Top Up 50 94-97
(R.O. 01903200)



24 647 0230



E-MARK

ARANCIO

24 647 0240



E-MARK

ARANCIO

24 647 0231



ARANCIO

24 647 0241



ARANCIO

24 647 0235



TRASPARENTE

24 647 0245



TRASPARENTE

POSTERIORE SINISTRA - LEFT REAR

MBK 50: Booster Ng 95-03
Booster Ng Eu1 99-00
Booster Track 96-98 - Rocket 97-98
YAMAHA 50 : Bw's Ng 97-05-Ng Cat 99-00
Bw's Bump 97-98 - Spy 95-98



POSTERIORE DESTRA - RIGHT REAR

MBK 50: Booster Ng 95-03
Booster Ng Eu1 99-00
Booster Track 96-98 - Rocket 97-98
YAMAHA 50 : Bw's Ng 97-05-Ng Cat 99-00
Bw's Bump 97-98 - Spy 95-98



24 647 0250



E-MARK

ARANCIO

24 647 0260



E-MARK

ARANCIO

24 647 0255



TRASPARENTE

24 647 0265



TRASPARENTE

ANTERIORE SINISTRA - LEFT FRONT

MBK 50: Nitro 99-04 - Nitro Eu2 03
Nitro Jaguar 04 - Nitro 100 00-02
YAMAHA 50 : Aerox R 99-00-Aerox 01-05
aerox Eu2 03-Aerox 100 00-02



ANTERIORE DESTRA - RIGHT FRONT

MBK 50: Nitro 99-04 - Nitro Eu2 03
Nitro Jaguar 04 - Nitro 100 00-02
YAMAHA 50 : Aerox R 99-00
Aerox 01-05-aerox Eu2 03
Aerox 100 00-02



24 647 0270



E-MARK

ARANCIO

24 647 0280



E-MARK

ARANCIO

24 647 0275



TRASPARENTE

24 647 0281



ARANCIO

POSTERIORE SINISTRA - LEFT REAR

MBK 50: Nitro 99-04 - Nitro Eu2 03
Nitro Jaguar 04 - Nitro 100 00-02
YAMAHA 50 : Aerox R 99-00 - Aerox 01-05
Aerox Eu2 03 - Aerox 100 00-02



24 647 0285



TRASPARENTE

POSTERIORE DESTRA - RIGHT REAR

MBK 50: Nitro 99-04 - Nitro Eu2 03
Nitro Jaguar 04 - Nitro 100 00-02
YAMAHA 50 : Aerox R 99-00 - Aerox 01-05
Aerox Eu2 03 - Aerox 100 00-02



24 647 0060



E-MARK

ARANCIO

24 647 0070



E-MARK

ARANCIO

24 647 0065



TRASPARENTE

24 647 0075



TRASPARENTE

ANTERIORE SINISTRA - LEFT FRONT

GILERA 50: Typhoon-x-xr 50-125 94-00
Storm 50 94-95
PIAGGIO 50: Ntt 95-96-Nrg 94-96
Nrg Rst Mc2 96-98-Typhoon 01
Zip Fast Raider Rst 96-97-Zip Sp 96-00
(R.O. 498435)



ANTERIORE DESTRA - RIGHT FRONT

GILERA 50: Typhoon-X-Xr 50-125 94-00
Storm 50 94-95
PIAGGIO 50: Ntt 95-96-Nrg 94-96
Nrg Rst Mc2 96-98-Typhoon 01
Zip fast raider Rst 96-97
Zip Sp 96-00
(R.O. 498436)





24 647 0080 

E-MARK ARANCIO

24 647 0090 

E-MARK ARANCIO

24 647 0081 

ARANCIO

24 647 0095 

TRASPARENTE

24 647 0085 

TRASPARENTE

POSTERIORE DESTRA - RIGHT REAR
GILERA 50: Typhoon-XXr 50-125 94-00
Storm 50 94-95
PIAGGIO 50: Ntt 95-96-Nrg 94-96
Typhoon 01
(R.O. 498438)

POSTERIORE SINISTRA - LEFT REAR
GILERA 50: Typhoon-XXr 50-125 94-00
Storm 50 94-95
PIAGGIO 50: Ntt 95-96-Nrg 94-96
Typhoon 01
(R.O. 498437)



24 647 0100 

E-MARK ARANCIO

24 647 0110 

E-MARK ARANCIO

24 647 0101 

ARANCIO

24 647 0115 

TRASPARENTE

24 647 0105 

TRASPARENTE

ANTERIORE DESTRA - RIGHT FRONT
PIAGGIO 50 cc:
Liberty 97-02-Liberty 4T 00-02
125 cc: Liberty 98-00
125-150 cc: Liberty 00-02
(R.O. 580101)

ANTERIORE SINISTRA - LEFT FRONT
PIAGGIO 50 cc:
Liberty 97-02-Liberty 4T 00-02
125 cc: Liberty 98-00
125-150 cc: Liberty 00-02
(R.O. 580100)



24 647 0120 

E-MARK ARANCIO

24 647 0130 

E-MARK ARANCIO

24 647 0125 

TRASPARENTE

24 647 0135 

TRASPARENTE

POSTERIORE SINISTRA - LEFT REAR
PIAGGIO 50 cc:
Liberty 97-02-Liberty 4T 00-02
125 cc: Liberty 98-00
125-150 cc: Liberty 00-02
(R.O. 580102)

POSTERIORE DESTRA - RIGHT REAR
PIAGGIO 50 cc: Liberty 97-02
Liberty 4T 00-02
125 cc: Liberty 98-00-L
125-150 cc: Liberty 00-02
(R.O. 580103)



24 647 0290 

E-MARK ARANCIO

24 647 0300 

E-MARK ARANCIO

24 647 0291 

ARANCIO

24 647 0301 

ARANCIO

24 647 0295 

TRASPARENTE

24 647 0305 

TRASPARENTE

ANTERIORE SINISTRA - LEFT FRONT
PIAGGIO 50: Nrg Extreme 99-00
Nrg Mc3 01-02 - Nrg Purejet 02-04
(R.O. 581290)

ANTERIORE DESTRA - RIGHT FRONT
PIAGGIO 50: Nrg Extreme 99-00
Nrg Mc3 01-02 - Nrg Purejet 02-04
(R.O. 581289)





LENTI FRECCIA
INDICATOR LENSES

24 647 0310 

E-MARK

ARANCIO

24 647 0320 

E-MARK

ARANCIO

24 647 0311 

ARANCIO

24 647 0321 

ARANCIO

24 647 0315 

TRASPARENTE

24 647 0325 

TRASPARENTE

POSTERIORE SINISTRA - LEFT REAR

PIAGGIO 50: Nrg Extreme 99-00
Nrg Mc3 01-02 - Nrg Purejet 02-04
(R.O. 294689)

POSTERIORE DESTRA - RIGHT REAR

PIAGGIO 50: Nrg Extreme 99-00
Nrg Mc3 01-02 - Nrg Purejet 02-04
(R.O. 294690)



24 647 0335 

LENTE FRECCIA POSTERIORE SINISTRA
(Trasparente)

LEFT REAR INDICATOR LENS (Clear)
YAMAHA: T Max 500 01-07

24 647 0345 

LENTE FRECCIA POSTERIORE DESTRA
(Trasparente)

RIGHT REAR INDICATOR LENS (Clear)
YAMAHA: T Max 500 01-07

24 647 0355 

LENTE FANALE POSTERIORE
(Trasparente)

REAR INDICATOR LENS (Clear)
YAMAHA: T Max 500 01-07



24 647 0375 

LENTE FRECCIA ANTERIORE DESTRA
(Arancione)

RIGHT FRONT INDICATOR LENS (Orange)
PIAGGIO: Vespa Px-T5-VNX-VLX-VSe-VNX2T
(R.O. 185977)

24 647 0365 

LENTE FRECCIA ANTERIORE SINISTRA
(Arancione)

LEFT FRONT INDICATOR LENS (Orange)
PIAGGIO: Vespa Px-T5-VNX-VLX-VSe-VNX2T
(R.O. 185976)

24 647 0395 

LENTE FRECCIA POSTERIORE DESTRA
(Arancione)

LEFT REAR INDICATOR LENS (Orange)
PIAGGIO: Vespa Px-T5-VNX-VLX-VSe-VNX2T
(R.O. 185979)



24 647 0385 

LENTE FRECCIA POSTERIORE SINISTRA
(Arancione)

LEFT REAR INDICATOR LENS (Orange)
PIAGGIO: Vespa Px-T5-VNX-VLX-VSe-VNX2T
(R.O. 185978)

24 647 0360 

LENTE FRECCIA ANTERIORE SINISTRA
(Bianca)

LEFT FRONT INDICATOR LENS (White)
PIAGGIO: Vespa PX -T5
VNX-VLX-VSe-VNX2T
(R.O. 196896)



24 647 0370 

LENTE FRECCIA ANTERIORE DESTRA
(Bianca)

RIGHT FRONT INDICATOR LENS (White)
PIAGGIO: Vespa PX -T5
VNX-VLX-VSe-VNX2T
(R.O. 196897)





24 647 0380



LENTE FRECCIA POSTERIORE SINISTRA
(Bianca)

LEFT REAR INDICATOR LENS (White)

PIAGGIO: VNX-VLX-VSE-VNX2T
(R.O. 196898)

24 647 0390



LENTE FRECCIA POSTERIORE DESTRA
(Bianca)

LEFT REAR INDICATOR LENS (White)

PIAGGIO: Vespa PX - T5 - VNX-VLX-VSE
VNX2T
(R.O. 196899)





FANALI ANTERIORI PIAGGIO VESPA

PIAGGIO VESPA HEADLAMPS

24 641 0030



In vetro mm 95 - *mm 95 glass*
Vespa 98 cc 125 • 125 51-53 Farobasso



24 641 0040



In vetro mm 105 completo di portalampada
mm 105 glass with holder
Vespa 50 N • S • R • L
(R.O. 101231)



24 641 0050



In vetro mm 115 comp. di portalampada e ghiera
mm 115 glass complete with holder and rim
Vespa GL 150 • Gs 150 • 160 Gs
(R.O. 92326)



24 641 0060



In vetro mm 115 con portalampada
mm 115 glass with holder
Vespa 125 Primavera • 150 Super • 90
(R.O. 144773)



24 641 0070



In vetro mm 130 con portalampada e ghiera
mm 130 glass complete with holder with rim
Vespa Rally 180- 200-150 Sprint Veloce
125 Gtr • Ts
(R.O. 144772)



24 641 0080



In vetro con portalampada e ghiera
front headlamp glass complete with holder with rim
Vespa GL 150 • 150 Sprint • 180 Ss
(R.O. 138508)



24 641 0090



In vetro mm 140 con portalampada
mm 140 glass with holder
Vespa Px 125-150-200 • Px 125-150-200
Arcobaleno
(R.O. 163685)



24 641 0100



Con portalampada
With holder
Vespa 50 Special • Elestart • V5A3T • VCB2T •
V5B4T
(R.O. 126695)



24 641 0110



In vetro mm 105 con portalampada
(Mercato Italiano - Italian market)
Front headlamp mm 105 glass with holder
Vespa 50 N-S-R-L V5A1
(R.O. 101321)





24 641 0170



In vetro mm 105 con portalamпада
mm 105 glass with holder
Vespa 150 VL2 - VL3
(R.O. 25483)



24 641 0180



In vetro mm 105 con portalamпада
mm 105 glass with holder
Vespa 150 VL2 - VL3
(R.O. 2373)



24 641 0190



In vetro mm 105 con portalamпада
mm 105 glass with holder
Vespa 125
VNA-VNA1-VNB1
(R.O. 87310)



24 641 0200



In vetro mm 105 con portalamпада
mm 105 glass with holder
Vespa 125
VM1T-VM2T-VN1T-VN2T
(R.O. 18087)



24 641 0210



In vetro mm 115 con portalamпада
mm 115 glass with holder
Vespa 150 Gs-150
VS1-VS2-VS3-VS4-VB1
(R.O. 25793)



24 641 0220



In vetro mm 115 con portalamпада
mm 115 glass with holder
Vespa 150 Gs-150
VS1-VS2-VS3-VS4-VB1



24 641 0230



In vetro mm 105 con portalamпада
mm 105 glass with holder
Vespa 125
VN1-VN2
(R.O. 26008)



24 641 0240



In vetro mm 105 con portalamпада
mm 105 glass with holder
Vespa 150 VL1 Struzzo
(R.O. 23447)





FANALI ANTERIORI PIAGGIO

PIAGGIO HEADLAMPS

24 641 0120



H4 12V 60-55W - BA15S 12V 5W

PIAGGIO 125: Vespa Granturismo Eu3 03-07 • Vespa Gts Eu3 07-12 - **200:** Vespa Granturismo 06-07
250: Vespa Gts 05-13 • Vespa Gts Abs 05-12
300: Vespa Gts ie Touring 11-12 • Vespa Gts ie 12-13
(R.O. 58267R-584977)



24 641 0130



BA 12V 35-35W - BA15S 12V 5W

PIAGGIO 50: Vespa Lx 2T Touring & 30 Km 10-13 • Vespa Lx 2T 05-13 • Vespa Lx 4T-4V Touring 10-13 • Vespa Lx 4T-4V 09-13 • Lx 4T 05-08
125: Vespa Lx 4T FL 09
(R.O. 58259R)



24 641 0140



H4 12V 60-55W - BA15S 12V 5W

PIAGGIO 125: Vespa Lx 4T 3V ie - Touring 12-13 • Vespa Lx 4T Eu3 Touring 10-11 • Vespa Lx 4T FL 09 • Vespa Lx Eu3 ie 09-11 • Vespa Lx Eu3 06-08 • Vespa Lx 05-06 - **150:** Vespa Lx 4T 3V ie - Touring 12-13 • Vespa Lx 4T FL 09 • Vespa Lx Eu3 ie 09-11 • Vespa Lx Eu3 06-08 • Vespa Lx Touring 10-12 • Lx 05-06
(R.O. 58260R)



24 641 0150



H4 12V 60-55W - BA15S 12V 5W

PIAGGIO 125: Fly 05-07 • Liberty 4T Eu3 07-08 • Liberty Rst 04-05 • Liberty 4T 2V Eu3 09-12 • Liberty 4T Eu3 Delivery - Single 07-12 • Liberty 4T 06-07 - **150:** Liberty 4T Eu3 08 • Fly 05-07 • Fly 05-07 • Liberty Moc 4T Eu3 09-13 - **200:** Liberty Rst 04 • Liberty 06 • Liberty 4T Eu3 06-08
(R.O. 58258R • 584787)



24 641 0160



H4 12V 60-55W - BA15S 12V 5W

PIAGGIO 125: Vespa Gts 4T ie Super 09-13
300: Vespa Gts Super 08-13
(R.O. 58265R)



**14 271 0010** **CORNICE FARO - HEAD LAMP RIM**Vespa 50 Special Elestart
(R.O. 124200)**14 271 0020** **CORNICE FARO - HEAD LAMP RIM**Vespa Primavera 125 • Et3 • Super
(R.O. 151742)**14 271 0030** **CORNICE FARO - HEAD LAMP RIM**Vespa 50 V5A1T
(R.O. 151713)**14 271 0040** **CORNICE FARO - HEAD LAMP RIM**Vespa 125-150 GL Sprint • Ss 180
VNL2T-VLB1T-VLA1T-VSC1T
(R.O. 070543)**14 271 0050** **CORNICE FARO - HEAD LAMP RIM**Vespa 125-150-180-200 Rally
VL2/3-VLB1T-VSD1-VSE
(R.O. 113981)**14 271 0060** **CORNICE FARO - HEAD LAMP RIM**Vespa Px 125-150-200
VNX2-VLX2-VSX2**14 271 0070** **CORNICE FARO - HEAD LAMP RIM**Vespa 125- Vit - V15
(R.O. 011902)**14 271 0080** **CORNICE FARO - HEAD LAMP RIM**Vespa 125-150-150 Gs -160 Gs
VNB3/4/5/6T-VBA-VBB-VGLA/B-VS5-VSB
(R.O. 084489)**14 271 0090** **CORNICE FARO - HEAD LAMP RIM**Vespa 150- 150 Gs VB1-VS1/2/3/4
(R.O. 025576)**14 271 0100** **CORNICE FARO - HEAD LAMP RIM**Vespa 125 VM1T/2-VN1T/2T
(R.O. 018088)**14 271 0110** **CORNICE FARO - HEAD LAMP RIM**Vespa 150 VL2T-VL3
(R.O. 025092)**14 271 0120** **CORNICE FARO - HEAD LAMP RIM**Vespa 125 VNA-VNB
(R.O. 082079)**14 271 0130** **CORNICE FARO - HEAD LAMP RIM**Vespa 125 VN2
(R.O.026009)**14 271 0140** **CORNICE FARO - HEAD LAMP RIM**Vespa 125 Struzzo
(R.O. 23444)



FANALI POSTERIORI PIAGGIO VESPA

PIAGGIO VESPA REAR LIGHTS

24 642 0010



Senza guarnizione - *Without gasket*
Vespa 125 Primavera
(R.O. 78641)

24 642 0020



Senza guarnizione - *Without gasket*
Vespa 50 N
(R.O. 78872)

24 642 0030



Senza guarnizione - *Without gasket*
Vespa 125-150 • Gs 150 • GL 150
(R.O. 93186)



24 642 0040



Senza guarnizione - *Without gasket*
Vespa 125 -150 • Super Sport • 150 Sprint
(R.O. 70700)

24 642 0050



Senza guarnizione - *Without gasket*
Vespa 125 -150 • Sprint • 180 Super Sport
(R.O. 91419)

24 642 0060



Senza guarnizione - *Without gasket*
Vespa 50 Special • 50 Elestart
(R.O. 143687)



24 642 0070



Senza guarnizione - *Without gasket*
Vespa 125-150 • Gs 150
(R.O. 021098)

24 642 0080



Senza guarnizione - *Without gasket*
Vespa 125
(R.O. 0184280001)

24 642 0090



Senza guarnizione - *Without gasket*
Vespa 125 51-53
(R.O. 014936)



FANALI POSTERIORI PIAGGIO VESPA

PIAGGIO VESPA REAR LIGHTS



24 642 0140



**CON GUARNIZIONE
WITH GASKET**

Vespa 50 S-N-L
V5A1T
(R.O. 104259)



24 642 0150



**CON GUARNIZIONE
WITH GASKET**

Vespa Px 125 -150 -200 1 serie
VNX-VLX-VSX-VLB-VBC
(R.O. 162740)



24 642 0160



**CON GUARNIZIONE
WITH GASKET**

Vespa Px Millenium
(R.O. 583081)



24 642 0170



**CON GUARNIZIONE
WITH GASKET**

PIAGGIO: Vespa 150 Sprint Veloce-180-200
Rally
VLB1T-VSD1T-VSE1T
(R.O. 121017)



24 642 0180



**CON GUARNIZIONE
WITH GASKET**

PIAGGIO: Vespa 125 Primavera-Et3-VMA2T-
VMB1T
(R.O. 159430)



24 642 0210



**FANALE POSTERIORE
REAR TAIL LAMP**

PIAGGIO: Vespa 125 T5
VNX5T
(R.O. 232774)



24 642 0100



**GUARNIZIONE FANALE POSTERIORE
REAR LIGHT GASKET**

Vespa 125 Primavera
(R.O. 711193)



24 642 0110



**GUARNIZIONE FANALE POSTERIORE
REAR LIGHT GASKET**

Vespa 50 N
(R.O. 4588)



24 642 0120



**GUARNIZIONE FANALE POSTERIORE
REAR LIGHT GASKET**

Vespa 150 GL • Gs • 125
(R.O. 89222)



24 642 0130



**GUARNIZIONE FANALE POSTERIORE
REAR LIGHT GASKET**

Vespa 150 Sprint • 180 Ss
(R.O. 70767)





LENTI FANALI POSTERIORI PIAGGIO VESPA

PIAGGIO VESPA REAR LENS

24 647 0406



Vespa Primavera 1° Serie
(R.O. 78627)

24 647 0416



Vespa 50 1° Serie
(R.O. 78715)



24 647 0426



Vespa Gs 125-150
(R.O. 89441)



24 647 0436



Vespa Sprint 150 • Sport Sprint
(R.O. 97440)

24 647 0446



Vespa SS 180
(R.O. 150369)



24 647 0456



Vespa 50 Special
(R.O. 125681)



24 647 0466



Vespa 125 VN1/2-VMA1/2
Vespa 150 VL1/2/3-VB1
Vespa 150 Gs VS1/2/3
(R.O. 020914)

24 647 0476



Vespa 125 '53



24 647 0486



Vespa 50 N-R-L
(R.O. 104259)



24 647 0496



Vespa GS VS4

24 647 0506



Vespa Px
1° Serie - 1st Series
(R.O. 162741)

24 647 0516



Vespa Px Millennium



▶ LAMPADINE

BULBS

LAMPADINE
BULBS

24 651 0315



12V 35/35W BA20D White

24 651 0319



12V 35/35W S2 BA20D White

E-MARK

24 651 0325



12V 45/40W BA20D White

24 651 0305



12V 25/25W BA20D White

24 651 0345



6V 25/25W BA20D White

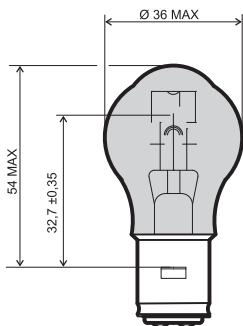

24 651 0495



6V 5W T8,5 x 31

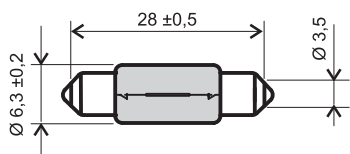

24 651 0635



12V 15W T11x35 s 8,5

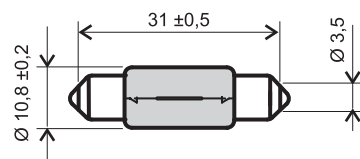

24 651 0175



12V 5W Siluro T11 x 39
12V 5W Festoon bulb T11 x 39

24 651 0165



12V 10W Siluro T11 x 39
12V 10W Festoon bulb T11 x 39

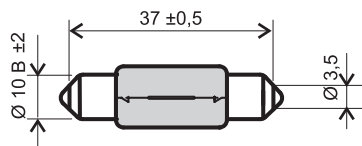

24 651 0125



6V 15W Siluro T15 x 44
6V 15W Festoon bulb T15 x 44

24 651 0135



6V 18W Siluro T15 x 44
6V 18W Festoon bulb T15 x 44

24 651 0145



12V 15W Siluro T15 x 44
12V 15W Festoon bulb T15 x 44

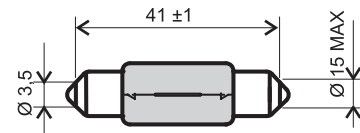

24 651 0405



12V 21/5W T20 White

24 651 0445



12V 21/5W T20 Orange

24 651 0385



12V 21W T20 White

24 651 0395



12V 21W T20 Orange

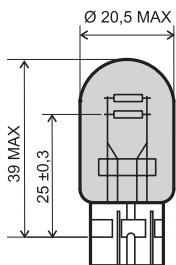

24 651 0265



12V 3W T10

24 651 0285



12V 5W T10

24 651 0280



12V-5W W2,1x9,5D

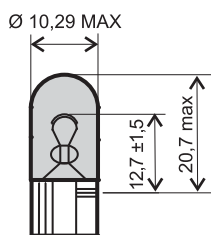

24 651 0245



12V 1,2W T5

24 651 0255



12V 2W T5

24 651 0275



12V 2,3W T5

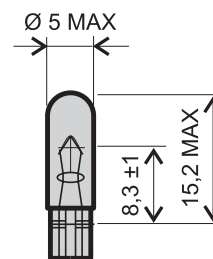

24 651 0015



LAMPADA TUBOLARE - TUBULAR BULB 90°

- 12V - 21W
- Poli innesto 90°

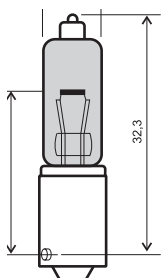

24 651 0025



LAMPADA TUBOLARE - TUBULAR BULB 180°

- 12V - 23W
- Poli innesto 180°

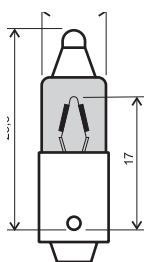



24 651 0335



6V 4W **BA9S** White



24 651 0195



12V 21W BULB **BA15S S25** White



24 651 0225



12V 5W BULB **BA15S G18** White



24 651 0415



12V 4W **BA9S** White



24 651 0205



12V 21W **BA15S S25** Orange



24 651 0235



12V 10W BULB **BA15S G18** White



24 651 0215



12V 10W BULB **BA15S G18** Orange



24 651 0645



6V 5W BULB **BA15S G18** White



24 651 0655



6V 10W BULB **BA15S G18** White

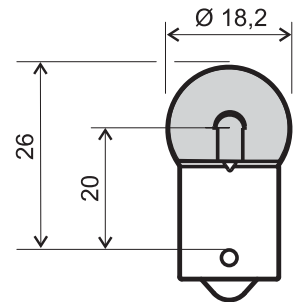
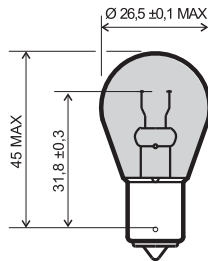
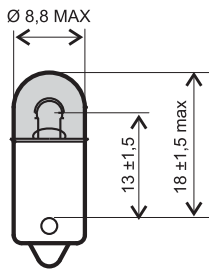

24 651 0365



12V 21/5W **BAY15D** White



24 651 0295



12V 15W **P26S** White



24 651 0105



12V 45/40W **P45T**

Asimmetrica White - *Asymmetric white bulb*



24 651 0375



12V 21/5W **BAY15D** Red

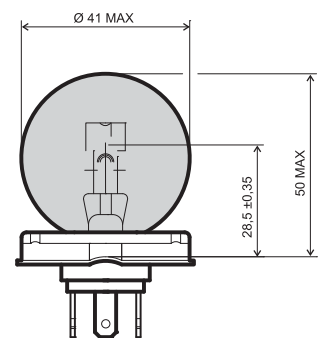
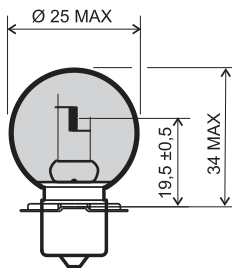
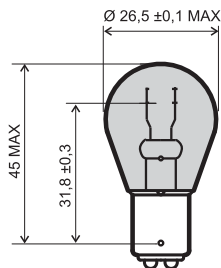

24 651 0465



12V-21W **S25 BAU15S** Orange



24 651 0675



12V-10W **T16 BAU15S** Orange **OSRAM**

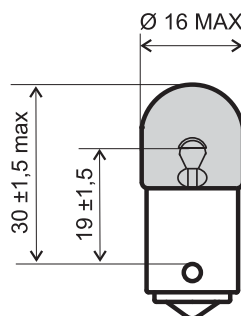
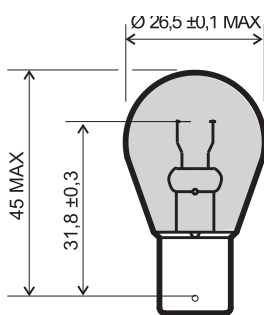

LAMPADINE
BULBS

24 651 0035



H1 12V 55W White

24 651 0045



H3 12V 55W White

24 651 0055



H4 12V 60/55W White

24 651 0030



H1 12V 55W Blue

24 651 0040



H3 12V 55W Blue

24 651 0050



H4 12V 60/55W Blue

24 651 0065



H4 12V-35/35W White

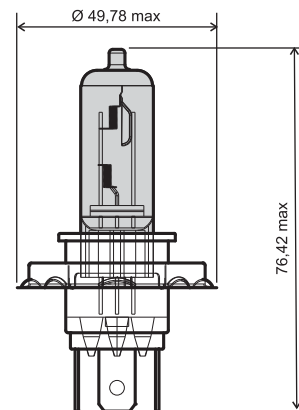
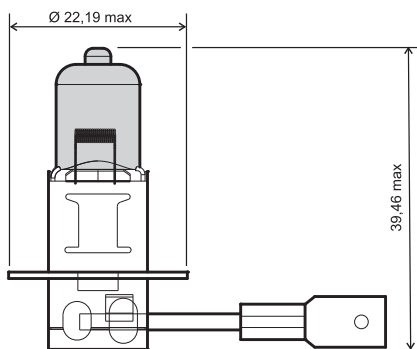
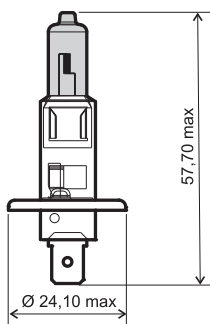

24 651 0075



H8 12V 35W White

24 651 0085



H11 12V 55W

24 651 0095



HB3 12V 65W

24 651 0070



H8 12V 35W Blue

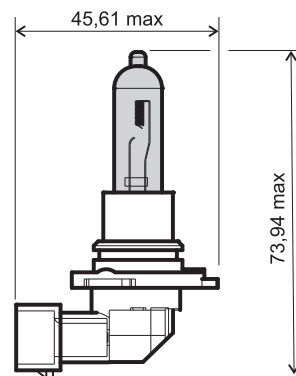
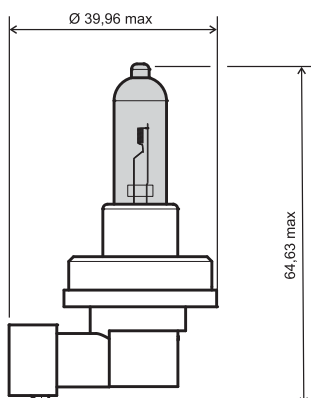
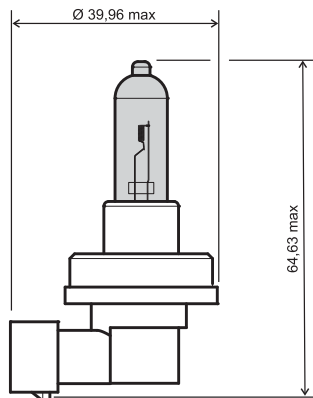



24 651 0115 

H7 12V 55W White



24 651 0355 

12V 35/35W BA20D White



24 651 0425 

12V-15W P26S White



24 651 0110 

H7 12V 55W Blue



24 651 0350 

12V 35/35W BA20D Blue



24 651 0420 

12V-15W P26S Blue

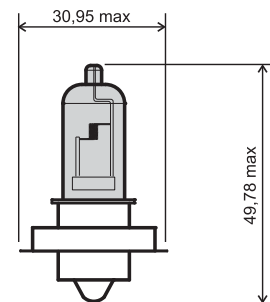
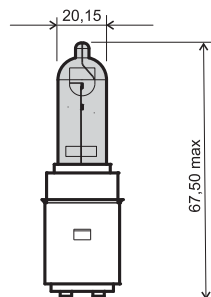
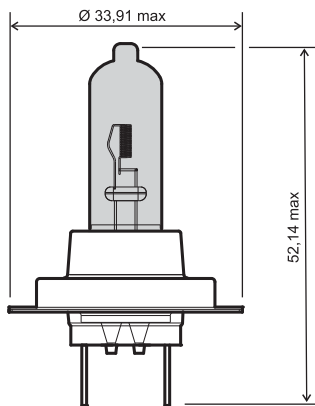

24 651 0435 

12V-20W P26S White



24 651 0185 

HS1 12V 35/35W White



24 651 0745 

LAMPADA BILUCE 12V 35/30 HS5
LOW/HIGH BEAN BULB 12V 35/30 HS5



24 651 0430 

12V-20W P26S Blue



24 651 0180 

HS1 12V 35/35W Blu

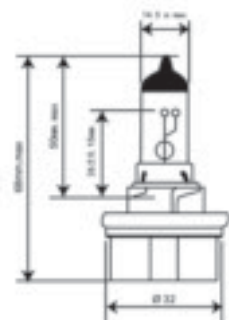
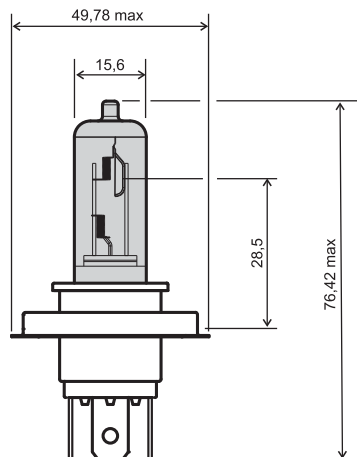
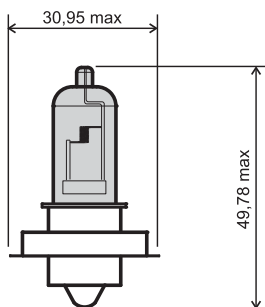



LAMPADINE
BULBS

24 651 0500  

Lampadine (2 pz) 12V 5 Led **G18 BA15S** Blue
Bulbs (2 pcs) 12V 5 Led **G18 BA15S** Blue

24 651 0530  

Lampadine (2 pz) 12V 6 Led **T20**
Doppia Intensità Blue
Bulbs (2 pcs) 12V 6 Led **T20**
Double intensity Blue

24 651 0540  

Lampadine (2 pz) 12V A 12 Led **BAY15D**
Doppia Intensità Blue
Bulbs (2 pcs) 12V 12 Led **BAY15D**
Double intensity Blue

24 651 0505  

Lampadine (2 pz) 12V 5 Led **G18 BA15S** White
Bulbs (2 pcs) 12V 5 Led **G18 BA15S** White

24 651 0535  

Lampadine (2 pz) 12V 6 Led **T20**
Doppia Intensità White
Bulbs (2 pcs) 12V 6 Led **T20**
Double intensity White

24 651 0545  

Lampadine (2 pz) 12V A 12 Led **BAY15D**
Doppia Intensità White
Bulbs (2 pcs) 12V 12 Led **BAY15D**
Double intensity White

24 651 0501  

Lampadine (2 pz) 12V 5 Led **G18 BA15S** Orange
Bulbs (2 pcs) 12V 5 Led **G18 BA15S** Orange

24 651 0531  

Lampadine (2 pz) 12V 6 Led **T20**
Doppia Intensità Orange
Bulbs (2 pcs) 12V 6 Led **T20**
Double intensity Orange

24 651 0542  

Lampadine (2 pz) 12V A 12 Led **BAY15D**
Doppia Intensità Red
Bulbs (2 pcs) 12V 12 Led **BAY15D**
Double intensity Red

Principali Applicazioni:

Frecce-Posizione

Main Applications:

Indicators-Low beam headlight

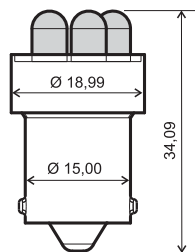

Principali Applicazioni:

Frecce

Main Applications:

Indicators

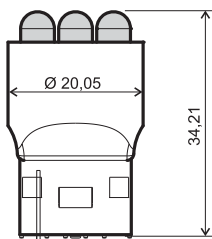

Principali Applicazioni:

Stop-Posizione

Main Applications:

Stop-Low beam headlight

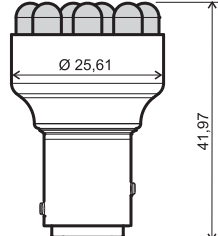

24 651 0510  

Lampadine (2 pz) 12V 12 Led S25 **BA15S** Blue
Bulbs (2 pcs) 12V 12 Led S25 **BA15S** Blue

24 651 0610  

Lampadine (2 pz) 12V 14 Led **H7** Blue
Bulbs (2 pcs) 12V 14 Led **H7** Blue

24 651 0515  

Lampadine (2 pz) 12V 12 Led S25 **BA15S** White
Bulbs (2 pcs) 12V 12 Led S25 **BA15S** White

24 651 0615  

Lampadine (2 pz) 12V 14 Led **H7** White
Bulbs (2 pcs) 12V 14 Led **H7** White

24 651 0511  

Lampadine (2 pz) 12V 12 Led S25 **BA15S** Orange
Bulbs (2 pcs) 12V 12 Led S25 **BA15S** Orange

Principali Applicazioni:

Posizione

Main Applications:

Low beam headlight

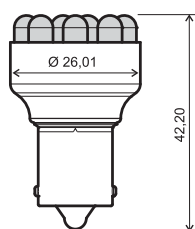

Principali Applicazioni:

Posizione

Main Applications:

Low beam headlight

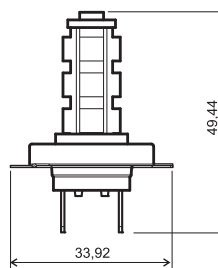



24 651 0555 

Led (2 pz) 12V **BA9S** White
Leds (2 pcs) 12V **BA9S** White

24 651 0550 

Led (2 pz) 12V **BA9S** Blu
Leds (2 pcs) 12V **BA9S** Blu

24 651 0565 

Led (2 pz) 12V T10 **W2,1X9,5D** White
Leds (2 pcs) 12V T10 **W2,1X9,5D** White

24 651 0560 

Led (2 pz) 12V T10 **W2,1X9,5D** Blu
Leds (2 pcs) 12V T10 **W2,1X9,5D** Blu

24 651 0561 

Led (2 pz) 12V T10 **W2,1X9,5D** Orange
Leds (2 pcs) 12V T10 **W2,1X9,5D** Orange

24 651 0575 

Led (2 pz) 12V T10 **W2,1X9,5** White 4 Led
Leds (2 pcs) 12V T10 **W2,1X9,5** White 4 Led

24 651 0570 

Led (2 pz) 12V T10 **W2,1X9,5** Blu 4 Led
Leds (2 pcs) 12V T10 **W2,1X9,5** Blu 4 Led

24 651 0571 

Led (2 pz) 12V T10 **W2,1X9,5** Orange 4 Led
Leds (2 pcs) 12V T10 **W2,1X9,5** Orange 4 Led

Principali Applicazioni:

Posizione-Cruscotto

Main Applications:

Low beam headlight-dashboard

Principali Applicazioni:

Frecce-Posizione-Targa

Main Applications:

Indicators-Low beam headlight-number plate light

Principali Applicazioni:

Frecce-Posizione-Targa

Main Applications:

Indicators-Low beam headlight-number plate light

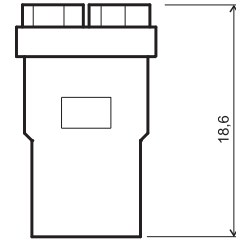
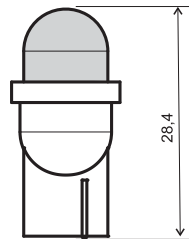
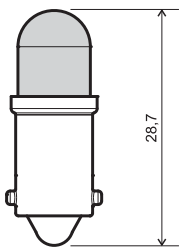

24 651 0595 

Led (2 pz) **SV8,5** 6 Led White
Leds (2 pcs) **SV8,5** 6 Led White

Principali Applicazioni: Luci Targa

Main Applications: Number plate light

24 651 0605 

Led (2 pz) **SV8,5** 4 Led White
Leds (2 pcs) **SV8,5** 4 Led White

Principali Applicazioni: Luci Targa

Main Applications: Number plate light

24 651 0585 

Led (2 pz) **SV8,5** 4 Led White
Leds (2 pcs) **SV8,5** 4 Led White

Principali Applicazioni: Luci Targa

Main Applications: Number plate light

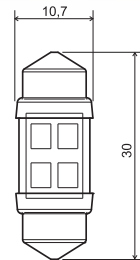
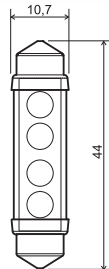
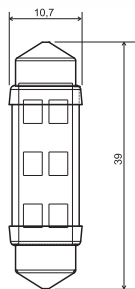

24 652 0012 

LED POSTERIORE ROSSO - REAR LED RED
People S 125-200

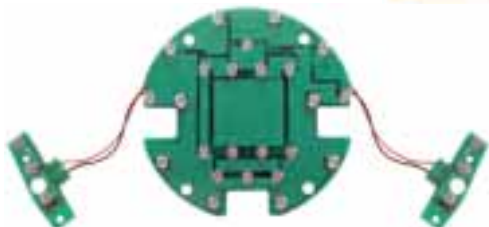

24 652 0010 

LED POSTERIORE BLU - REAR LED BLUE
People S 125-200





LED CONVERSION KIT

LED CONVERSION KIT

LED CONVERSION KIT

- Led super brillante con microchip integrato
- Sistema di ventilazione forzata con ventola
- Adattatori temperatura colore 5000K-6000K-8000K
- Corpo interamente in alluminio

- Super bright leds with integrated microchip
- Fan air cooling system
- 5000K-6000k-8000k color lampshade
- Billet aluminium body

Prima di installare:

Controllare gli ingombri della base della lampadina nel portalampada

Before installing:

Check if dimensions of the bulb base are correct for your head lamp

24 651 0685



LAMPADA LED H4 ANABBAGLIANTI-ABBAGLIANTI
H4 LED BULB HIGH AND LOW BEAM

24 651 0695



LAMPADA LED H7- H7 LED BULB

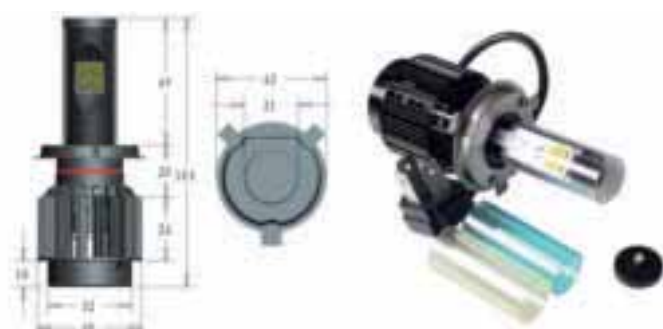

24 651 0705



LAMPADA LED H8-H9-H11 - H8-H9-H11 LED BULB

24 651 0715



LAMPADA LED H1 - H1 LED BULB





LAMPADINE A LED

LED BULBS

24 651 0765



HB3
580 Lumen
27 Led



24 651 0775



H7
580 Lumen
27 Led



24 651 0785



H4
600 Lumen
24 Led



24 651 0795



H8 H9 H11
580 Lumen
26 Led



24 651 0805



9006
580 Lumen
26 Led



24 651 0945



BA20D
480 Lumen
Hi Power Led



24 651 0895



BA15D
410 Lumen
24 Led



24 651 0905



BA15S
450 Lumen
27 Led



24 651 0925



BA15S
150 Lumen
8 Led



24 651 0885



BA15D
410 Lumen
24 Led



24 651 0915



BA15S
450 Lumen
27 Led



24 651 0935



BA15S
150 Lumen
8 Led



24 651 0965 

BA9S
90 Lumen
5 Led



24 651 0985 

BA9S (Canbus)
140 Lumen
9 Led



24 651 0975 

BA9S
90 Lumen
5 Led



24 651 0995 

BA9S (Canbus)
140 Lumen
9 Led



24 651 1005 

BAY15S
450 Lumen
24 Led



24 651 1015 

BAY15S
450 Lumen
24 Led



24 651 1025 

BAY15D
410 Lumen
24 Led



24 651 1035 

BAY15D
410 Lumen
24 Led



24 651 1045 

C10W 31 mm (Canbus)
150 Lumen
6 Led



24 651 1065 

C10W 39 mm (Canbus)
150 Lumen
9 Led



24 651 1075 

C10W 41 mm (Canbus)
150 Lumen
6 Led





LAMPADINE A LED

LED BULBS

24 651 0815



T10 (Canbus)
465 Lumen
13 Led



24 651 0825



T10 (Canbus)
90 Lumen
6 Led



24 651 0835



T10 (Canbus)
30 Lumen
2 Led



24 651 0855



T10 (Canbus)
90 Lumen
6 Led



24 651 0845



T10 (Canbus)
30 Lumen
2 Led



24 651 0865



T20
280 Lumen
24 Led



24 651 1095



T20 Biluce
280 Lumen
24 Led



24 651 0875



T20
280 Lumen
24 Led





24 613 0020 

PULSANTE CLACSON - HORN BUTTON
PIAGGIO: Versione Nera - *Black Version*



24 613 0050 

PULSANTE SPEGNIMENTO - STOP BUTTON
PIAGGIO: Vespa Rally 200
 (R.O. 073185)



24 613 0060 

PULSANTE CLAXON - HORN BUTTON
PIAGGIO: Zip • Fly • Nrg • Vespa Et4 • Vespa Gts
 Liberty • Carnaby • Beverly • X8 • X9 • X Evo
 (R.O. 58058R)



24 613 0070 

PULSANTE CLAXON - HORN BUTTON
PIAGGIO: Vespa Lx • Vespa Gts • Mp3
 (R.O. 641358)



24 613 5030 

PULSANTE AVVIAMENTO - STARTING BUTTON
PIAGGIO: Zip • Fly • Nrg • Vespa Et4 • Vespa Gts
 Liberty • Carnaby • Beverly • X8 • X9 • X Evo
 (R.O. 58057R)



24 613 5040 

PULSANTE AVVIAMENTO - STARTING BUTTON
PIAGGIO: Vespa Lx • Vespa Gts • Mp3
 (R.O. 641359)



24 613 0280 

PULSANTE ANTI SLIP - ASR BUTTON
PIAGGIO 125: X10 4T 4V ie Eu3 12-13 • **350:**
 Beverly 4T 4V ie Eu3 Sport Touring 11-13 • X10
 4T 4V ie Eu3 12-13 • **500:** X10 4T 4V ie Eu3 12-13
 (R.O. 643130)



24 613 0200 

PULSANTE MODE - MODE SWITCH
PIAGGIO 125: Liberty Elettrico Ppt Aut 11 • Beverly Rst 4T 4V ie
 Eu3 10-13 • Mp3 ie Touring 11-12 • Mp3 ie 08-09 • Mp3 Yourban
 ERL 11-12 • Mp3 06-08 • X Evo 07-12 • **250:** Mp3 Lt 08-09 •
 Mp3 Mic 08-09 • Mp3 06-08 • X Evo 07-13 • **300:** Beverly Rst 4T
 4V ie Eu3 10-13 • Mp3 ie Mic 11 • Mp3 ie Lt Touring 11-12 • Mp3
 ie Lt ie Lt Sport 11-13 • Mp3 ie Touring 11-12 • Mp3 ie Lt 10-11 •
 Mp3 Le Mic 10 • Mp3 Yourban ERL 11 • Mp3 Yourban Lt ERL 11-12
 • **350:** Beverly 4T 4V ie Eu3 Sport Touring 11-13 • **400:** Mp3 ie Lt
 - Mp3 ie Lt Sport 08-10 • Mp3 ie Lt Touring 11 • Mp3 Mic 08-10 •
 Mp3 RL Touring 11 • Mp3 07-08 • X Evo 07-11 • **500:** Mp3 Lt Sport
 - Business 11-13 • Mp3 RL Sport - Business 11-12
 (R.O. 58255R - Ex 639140)



24 613 0220 

PULSANTE EMERGENZA - EMERGENCY BUTTON
APRILIA 250: Scarabeo Light 06-08 • **300:** Scarabeo Light 09-10 • **400:** Scarabeo Light 06-08
 (R.O. AP8127894)
GILERA 500: Fuoco Eu3 07-13
PIAGGIO 125: Mp3 Ibrido 09-10 • Mp3 ie 08-09 • Mp3 Yourban ERL 11-12 • Mp3 06-08 • Mp3 ie Touring 11-12
 • X Evo 07-12 • X9 Evolution Eu3 07 • X9 Evolution 03-06 • X 9 01-02 **180:** X9 Amalfi 00-03 • **200:** X9 Evolution
 03 • X9 02-03 • **250:** Mp3 Lt 08-09 • Mp3 Mic 08-09 • Mp3 06-08 • X Evo 07-13 • X9 Evolution 04-06 • X9 00-01 •
300: Mp3 ie Mic 11 • Mp3 ie Lt 10-11 • Mp3 ie Mic 10 • Mp3 Yourban ERL 11 • Mp3 Yourban Lt ERL 11-12 • Mp3
 ie Lt Touring 11-12 • Mp3 ie Lt-ie Lt Sport 11-13 • Mp3 ie Touring 11-12 • **400:** Mp3 ie Lt - Mp3 ie Lt Sport 08-
 10 • Mp3 ie Lt Touring 11 • Mp3 Mic 08-10 • Mp3 RL Touring 11 • Mp3 07-08 • X Evo 07-11 • **500:** X9 Evolution
 Abs 06-07 • X9 Evolution 03-07 • X9 01-02
 (R.O. 58284R - 511411)





PULSANTI - DEVIO LUCI - AVVIAMENTO

BUTTONS - LIGHTS SWITCHES - START BUTTONS

24 613 0230



PULSANTE APERTURA SELLA - SADDLE OPENING BUTTON

APRILIA 850: Srv - Srv Abs Atc 12-13

GILERA 800: Gp 09-11 • PIAGGIO 125: Beverly Eu3 Mic 07 • Beverly Eu3 Sport 07-08 • Beverly Eu3 07-08 • Beverly Rst 4T 4V ie Eu3 10-13 • Beverly Rst 04-07 • Beverly Tourer Eu3 07-10 • Beverly 01-03 • Mp3 Ibrido 09-10 • Mp3 ie Touring 11-12 • Mp3 ie 08-09 • Vespa Gt Eu3 06-07 • Vespa Gt 04-07 • Vespa Gts 4T ie Super 09-13 • Vespa Gts Eu3 07-12 • Vespa Gts Eu3 07-12 • Vespa Gtv 4T Navy Eu3 08 • Vespa Gtv 06-08 • Vespa Lx Primavera 4T 3V ie 13 • Vespa Sprint 4T 3V ie 14 • X10 4T 4V ie Eu3 12-13 • X8 Premium Eu2 06 • X8 Premium Eu3 06-07 • X8 Street Eu2 06-07 • X8 04-06 • X9 Evolution Eu3 07 • X9 Evolution 05-06 • 150: Vespa Primavera 4T-3V 13 • X8 Street Eu2 06-08 • 200: Vespa Gt 06-07 • X8 05-07 • 250: Beverly Eu3 Mic 07 • Beverly ie Eu3 06-08 • Beverly Rst 04-05 • Beverly Sport 06-08 • Beverly Tourer Eu3 08-09 • Beverly 06-07 • Mp3 Mic 08-09 • Vespa Gt 60 Eu3 06-07 • Vespa Gts Abs 05-12 • Vesta Gts 05-13 • Vespa Gtv 4T Navy Eu3 07 • Vespa Gtv 06-09 • X8 Eu3 05-08 • X9 Evolution 04-06 • 300: Beverly Rst 4T 4V ie Eu3 10-13 • Beverly Tourer Eu3 09-10 • Mp3 ie Lt 10-11 • Mp3 ie Mic 10-11 • Mp3 4T 4V ie ERL Ibrido 10-13 • Mp3 4T 4V ie Lt Ibrido 10-11 • Mp3 ie Lt Touring 11-12 • Mp3 ie Lt - ie Lt Sport 11-13 • Mp3 ie Touring 11-12 • Vespa Gts ie Touring 11-12 • Vespa Gts ie 12-13 • Vespa Gts Super Sport 10-13 • Vespa Gts Super 08-13 • Vespa Gtv 4T 4V ie 10-13 • Vespa Gtv Via Montenaepoleone 10 • 350: Beverly 4T 4V ie Eu3 Sport Touring 11-13 • X10 4T 4V ie Eu3 12-13 • 400: Beverly Eu3 06-07 • Beverly Tourer Eu3 08-10 • Mp3 ie Lt - Mp3 ie Lt Sport 08-10 • Mp3 ie Lt Touring 11 • Mp3 Mic 08-10 • Mp3 RL Touring 11 • X Evo 07-11 • X8 Eu3 06-08 • 500: Beverly Eu3 06-08 • Beverly 02-06 • Mp3 Lt Sport - Business 11-13 • Mp3 RL Sport - Business 11-12 • X10 4T 4V ie Eu3 12-13 • X9 Evolution Abs 06-07 • X9 Evolution 06-07 (R.O. 582988)



24 613 0240



PULSANTE REGOLAZIONE AMMORTIZZATORE SHOCK ABSORBER REGULATION BUTTON

PIAGGIO 500: X10 4T 4V ie Eu3 12-13

(R.O. 643231)



24 613 5060



PULSANTE AVVIAMENTO START BUTTON

PIAGGIO VESPA: 50: N 89-90 • Pk XL PLurimatic 85-90 • Pk XL Rush 88-89 • Pk XL 85-88 • Pk 82-84 • 125: Pk XL 86-89 • Px 30 anni 07-08 • Px Eu2 01-07 • Px T5 85-89 • Px 98-13 • Pxe Arcobaleno 81-97 • 150: Px 11-13 (R.O. 580937)



24 611 0500



INTERUTTORE TERGICRISTALLO WINDSCREEN WIPER SWITCH

PIAGGIO 50: Ape 09 • Mix 2T 98-08 • Rst Mix 99-03 • FL3 Europa 96-99 • FL-FL2 89-95 (R.O. 584097)



24 613 0210



PULSANTE TRIP - TRIP SWITCH

PIAGGIO 125: Mp3 Ibrido 09-10 • 300: Mp3 4T 4V ie ERL Ibrido 10-13 • Mp3 4T 4V ie Lt Ibrido 10-11

(R.O. 641837)



24 613 5050



PULSANTE AVVIAMENTO START BUTTON

GILERA 50: Typhoon X 98-99 • Typhoon Xr 00 • Typhoon 94-97 • 125: Typhoon X-Xr 99-00 • Typhoon 95-98
PIAGGIO 50: Ape FL3 Europa 96-99 • Ape Mix 2T 98-08 • Ape Rst Mix 99-03 • Ape 09 • Free Delivery 00-01 • Free FL 95-02 • Free 92-94 • Nrg Rst Mc2 96-98 • Nrg 94-96 • Ntt 95-96 • Quartz 92-96 • Sfera Maquillage 2 94 • Sfera 91-93 • Zip Fast Raider Rst 96-97 • Zip Fast Raider 93-94 • Zip Rst 96-99 • Zip Sp 96-00 • Zip 92-93 • 80: Skr City 99 • 100: Free 02-03 • 125: Hexagon 94-97 • Skipper 94-97 (R.O. 294398)



24 613 0010



PULSANTE CLAXON - HORN SWITCH

PIAGGIO 50: Ape FL - FL2 89-95 • Ape FL3 Europa 96-99 • Ape Mix 2T 98-08 • Ape Rst Mix 99-03 • Ape 09 • Free Delivery 00-01 • Free FL 95-02 • Nrg Rst Mc2 96-98 • Nrg 94-96 • Ntt 95-96 • Quartz 92-96 • Sfera Maquillage 2 94 • Sfera 91-93 • Velofax 96-99 • Zip Bimodale 94-97 • Zip Fast Raider Rst 96-97 • Zip Fast Raider 93-94 • Zip Rst 96-99 • Zip Sp 96-00 • Zip 92-96 • Skr City 99 • 100: Free 02-03 • 125: Hexagon 94-97 • Skipper 94-97 (R.O. 290679 - Ex 292364)



**ARTICOLO RIPRISTINATO
REACTIVATED CODE**



24 609 0190 

DEVIO LUCI - LIGHT SWITCH
PIAGGIO: Mp3 • X7 • X8 • X9 • X Evo
 (R.O. 294877)



24 609 0200 

DEVIO LUCI CON SPRAZZO
LIGHT SWITCH WITH FLASH
PIAGGIO: Mp3 • X7 • X8 • X9 • X Evo
 (R.O. 642967)



24 609 0210 

DEVIO LUCI - LIGHT SWITCH
PIAGGIO: Liberty 97-05 • Sfera Rst 95-97
 • Vespa Et2 97-05 • Vespa Et4 96-05
 (R.O. 293571)



24 609 0220 

DEVIO LUCI - LIGHT SWITCH
PIAGGIO 50: Typhoon 01- 04
125: Hexagon Gtx 98-99 • Hexagon Lx-Lxt 98-99
 Hexagon Lx4 98-99 • Skipper 4T 00-02 • Skip-
 per Lx 98-99 • Super Hexagon Gtx 12 01-02 •
 X9 01-02 • Zip 00-02 • **180:** X9 Amalfi 00-03 •
200: X9 02-03 • **250:** Hexagon Gt-Gtx 98-00 •
 X9 00-01
500: Beverly 02-04 • X9 01-02
 (R.O. 294340)



24 609 0030 

DEVIO LUCI (DX) - LIGHT SWITCH (RH)
MBK 50: Booster Spirit • Spirit Eu2 99-02 • Ng
 01-02 • Booster • L Booster 01-02 • Stunt 00-02
YAMAHA 50: Bw's Next G 01-02 • Next G. Cat.
 99-01 • Bw's original 99-02 • Bw's R 01 • Bw's
 Orig. Eu2 02 • Slider 00-02
 (R.O. 5JHH39750000)



24 609 0040 

DEVIO LUCI (DX) - LIGHT SWITCH (RH)
MBK 50: Booster Ng • Ng Eu1 99-00 • Booster
 Spirit 99-00
YAMAHA 50: Bw's original 99-00 • Bw's Next •
 Generation 99-00
 (R.O. 5FXH39750000)



24 609 0230 

DEVIO LUCI - LIGHT SWITCH
PIAGGIO 50: Zip • Liberty • Fly • Nrg Power
125: Zip • Liberty • Fly
 (R.O. 642968)



24 609 0250 

DEVIO LUCI 2 posizioni
LIGHT SWITCH 2 positions
GILERA 50: Runner 97-00
PIAGGIO 50: Nrg Extreme 99-00 • Nrg Mc3
 01-04 • Zip 4T 00-05 • Zip Sp 01-04 • Zip 00-04
 (R.O. 294714)



24 609 0260 

DEVIO LUCI - LIGHT SWITCH
PIAGGIO 125: Vespa Px 30 Anni 07-08 • Vespa
 Px Eu2 01-07 • Vespa Px 11-13
150: Vespa Px 11-13
 (R.O. 583090)



24 609 0270 

DEVIO LUCI - LIGHT SWITCH
GILERA 125: Typhoon 95-98 • Typhoon X-Xr
 99-00
PIAGGIO 50: Zip Rst 96-99 • **80:** Skr City 99 •
125: Hexagon 94-97 • Skipper 94-97
 (R.O. 291954)



24 609 0280 

DEVIO LUCI - LIGHT SWITCH
PIAGGIO 50: Ape FL-FL2 89-95 • Ape FL3
 Europa 96-99 • Ape Mix 2T 98-08 • Ape Rst Mix
 99-03 • Ape 09 • Sfera 91-93
 (R.O. 294370)



24 609 0180 

DEVIO LUCI (DX) - LIGHT SWITCH (RH)
KYMC0 50: Agility (Tutti - All) • Super 8 2T 09
125: Agility Carry 11 • Agility R16 12 • Agility Rs 09
200: Agility I R16 10 • Agility R16 12
 (R.O. 00135055)





PULSANTI - DEVIO LUCI - AVVIAMENTO
BUTTONS - LIGHTS SWITCHES - START BUTTONS

24 609 0050



DEVIO LUCI - LIGHT SWITCH

PIAGGIO: Vespa 150 64 Gi - Sprint
 (R.O. 087558)

24 609 0240



DEVIO LUCI - LIGHT SWITCH

PIAGGIO: Vespa 50-S-Ss-V5SA1T-V5SS1T
 (R.O. 73169)



24 609 0060



DEVIO LUCI - LIGHT SWITCH

PIAGGIO: Vespa 50-90 Primavera • Sprint
 Super - (R.O. 092041)

24 609 0070



PIAGGIO: Vespa 50 R • Super Sprint
 (R.O. 092654)



24 609 0080



DEVIO LUCI - LIGHT SWITCH

PIAGGIO: Vespa Rally 200 Senza Batteria
No battery
 (R.O. 143324)



24 609 0090



DEVIO LUCI - LIGHT SWITCH

PIAGGIO: Vespa Px • Pe
 (R.O. 215668)



24 609 0100



DEVIO LUCI - LIGHT SWITCH

PIAGGIO: Vespa Pk 125
 (Senza batteria • senza avviam. elettrico)
(Without battery and electric starter)
 (R.O. 232240)



24 609 0110



DEVIO LUCI - LIGHT SWITCH

PIAGGIO: Vespa 50 Special
 (R.O. 123152)



24 611 0090



DEVIO FRECCHE - INDICATORS SWITCH

APRILIA 50: Sport City One 2T/4T 08-11 • Sr Motard 12-13 • **125:** Sport City One 4T Eu3 08-11 • Sr Motard 12-13
GILERA 50: Runner Purejet 2T 05-07 • Runner Sp 97-09 • Stalker 97-11 • Storm Eu2 07
125-180: Runner Fx/Fxr 97-02 • **125:** Runner 4T/Vx/Race Eu3 02-13 • **200:** Runner Vxr 02-11
PIAGGIO 50: Fly 4T 2V 13 • Liberty 4T Ptt (Deu) 07-12 • Liberty Moc 4T & Elle 09-13 • Nrg Power DD 07-13 • Nrg Power Purejet 10-11
125: Fly 4T 3V ie Eu3 Lem 12-13 • Liberty 4T 2V Eu3 09-12 • Liberty 4T Sport Eu3 06-08 • Liberty 4T 06-07 • Liberty Sport 06 • Mp3 Yourban ERL 11-12 • X7 Eu3 08 • **150:** Liberty 4T Eu3 08 • Liberty 4T Sport Eu3 08 • **200:** Liberty 4T Eu3 06-08 • Liberty 4T Sport Eu3 06-07 • **250:** X7 Eu3 08 • **300:** Mp3 ie Mic 11 • X7 Evo le Eu3 09-10 • **400:** Mp3 ie Lt Touring 11 • Mp3 RL Touring 11 • Mp3 RL Touring 11 • X Evo 07-11 • X8 Eu3 06-08 • **500:** Mp3 Lt Sport - Business 11-13
 (R.O. 58056R)



24 611 0080



DEVIO FRECCHE - INDICATORS SWITCH

APRILIA 250: Scarabeo Light 06-08 • Scarabeo Light 09-10 • **300:** Scarabeo Light 09-10
400: Scarabeo Light 06-08 • (A.O. AP8127892)
PIAGGIO 125: X9 Evolution 03 • X9 Evolution Eu3 07 • X9 Evolution 05-06 • X9 01-02
250: X9 Evolution 04-06 • X9 00-01
500: X9 Evolution Abs 06-07 • X9 Evolution 03-07
 (R.O. 638708)



24 611 0010



DEVIO FRECCHE - INDICATORS SWITCH

GILERA: Easy Moving 50 95-96 • Storm 50 94-95 • Typhoon 50 94-97 • Typhoon X 50 98-99 • Typhoon Xr 00 • Typhoon 125 95-98 • Typhoon X-Xr 125 99-00
PIAGGIO: Ape FL • FL2 50 89-95 • Ape Rst Mix 50 99-01 • Ape FL3 Europa 50 96-99 • Free 50 92-00 • Free Delivery 50 00-01 • Nrg 50 94-96 • Nrg Rst Mc2 50 96-98 • Ntt 50 95-96 • Quartz 50 92-96 • Sfera Maquillage 2 50 94 • Sfera Base 50 91-93 • Skipper 125-150 94-97 • Skr City 80 99 • Velofax 50 96-99 • Zip Rst 50 96-99 • Zip-Fast R. 50 93-97 • Zip Sp 50 96-97 • Zip Base 50 95-96 • Zip & Zip Bim. 50 94-97
 (R.O.294917)





24 611 0050 

DEVIO LUCI (SX) - LIGHT SWITCH (LH)

KYMCO 50: Agility (Tutti) • Super 8 2T 07 • People S 05-08 • People S 4T 06-08 • People Eu 2 11
125: Agility Carry 11 • Agility R16 08-12 • People S 05 • People S Dd Eu 3 07-08 • People Eu 3 11 • Super 8 08-09
150: Agility R16 08-09
200: Agility I R16 10 • Agility R16 12
 • People S 05 • People S I 07
 (R.O. 00152643)



24 611 0060 

**COMMUTATORE FRECCHE
 INDICATORS SWITCH**

PIAGGIO: Vespa S • Vespa Lx • Vespa Et4 • Vespa Gts • Sfera • Liberty
 (R.O. 294723)



24 611 0030 

**DEVIO FRECCHE (SX)
 INDICATORS SWITCH (LH)**

MBK 50: Booster Ng • Ng Eu1 99-00 • Booster Spirit 99-00
YAMAHA 50: Bw's original 99-00 • Bw's Next • Generation 99-00
 (R.O. 5FXH39760000)



24 611 0020 

**DEVIO FRECCHE (SX)
 INDICATORS SWITCH (LH)**

MBK 50: Spirit • Spirit Eu 2 99-02 • Ng 01-02 • Booster • L Booster 01-02 • Stunt 00-02 • Mach G 02
YAMAHA 50: Bw's Next G. Cat. • Next G. 99-02
 • Bw's original 99-02 • Bw's R 01 • Slider 00-02
 • Jog R 02
 (R.O. 5JHH39760000)



24 611 0040 

**COMMUTATORE FRECCHE
 INDICATORS SWITCH**

PIAGGIO: Vespa Px • Pe
 (R.O. 215669)



24 611 0070 

DEVIO FRECCHE - INDICATORS SWITCH

PIAGGIO VESPA: 50: Pk 82-84 • N 89-90 • Pk Automatica 84-89 • Pk XL Plurimatic 85-90 • Pk XL Rush 85-90 • Pk XL 85-88 • **125:** Pk XL 86-89 • Px Eu2 01-07 • Px 30 anni 07-08 • Px T5 85-89 • Px 98-13 • Pxe Arcobaleno 81-97
 (R.O. 580395
 Ex 231849)



24 614 0510 

BOCCOLA COLLEGAMENTO-BUSH CONNECTOR

PIAGGIO VESPA: 50: Px 30 anni 07-08 • Px Eu2 01-07 • Px T5 85-89 • Px 98-13 • Pxe Arcobaleno 81-97 • **150:** Px 11-13
 (R.O. 216053)



24 614 0500 

PULSANTE CONSENSO AVVIAM.-SWITCH START

PIAGGIO VESPA: 50: N 89-90 • Pk XL Rush 88-89 • Pk XL 85-88 • **125:** Pk XL 86-89 • Pk 30 anni 07-08 • Px Eu2 01-07 • Px T5 85-89 • Px 98-13 • Pxe Arcobaleno 81-97 • **150:** Px 11-13
 (R.O. 583330)





CLACSON
HORN

24 607 0010



APRILIA 50 - CAGIVA 50 - HONDA 50 - LEM 50
MALAGUTI 50: - (R.O.01801600)
MBK 50 - PEUGEOT 50-125 - SUZUKI 50
YAMAHA 50-125

24 607 0020



12 V C.C.
APRILIA 50: (R.O. AP 8212587)

24 607 0030



12 V C.C. - Ø 71/65
(Staffa foro filettato Ø 6 mm
Threaded bracket hole Ø 6 mm)
GILERA 50-125-200-250-300-500
PIAGGIO 50-125-150-180-200-250-500
(R.O. CM071801 > 58034R)



24 607 0040



6 V C.A. 18-24 W
PIAGGIO 50-125: (R.O. 070300)



24 607 0050



12 V C.A. 18-24 W
PIAGGIO 125-150-200: Vespa Px
(R.O. 2189379)



24 607 0060



12 V C.C. - Ø 71/65
(Staffa foro Ø 6 mm - *Bracket hole Ø 6 mm*)
GILERA 50-125-180-200-500
PIAGGIO 50-125-150-200-250-400
(R.O. 294828 > 58033R > CM071803)



24 607 0070



12 V C.C. - Ø 71/65
(Staffa foro filettato Ø 6 mm
Threaded bracket hole Ø 6 mm)
GILERA 50 - PIAGGIO 50-125-250-400
(R.O. CM071804)



24 607 0080



12 V C.C. - Ø 71/65
(Staffa foro Ø 6mm - *Bracket hole Ø 6 mm*)
GILERA 50 - PIAGGIO 50-100-125-150-250-300
(R.O. CM071805 > 58093R)



24 607 0090



12 V C.C. - Ø 71/65
(Staffa foro Ø 6 mm - *Bracket hole Ø 6 mm*)
PIAGGIO 125-150-200-250-400
(R.O. CM071806 > 58092R)





24 607 0100



12 V C.C. - Ø 71/65

(Staffa foro Ø 4 mm - Bracket hole Ø 4 mm)

PIAGGIO 50-125-150-200:

Pk 125 (avviamento elettrico-electric starter)

Ape 50 (Tutti - All)

(R.O. CM071807 > 58144R)



24 607 0110



12 V C.C. - Ø 71/65

(Staffa foro filettato Ø 6mm

Threaded bracket hole Ø 6 mm)

GILERA 50

PIAGGIO 50-100-125-150-250-400-500

(R.O. 58094R > 58131R > CM071802 -

CM071814)



24 607 0121



TROMBA - HORN - 12 V C.C. - Ø 81

(Staffa foro Ø 8 mm - Bracket hole Ø 8 mm)

PIAGGIO 125-180-200-250-500

(R.O. 581441 > 640474)



24 607 0130



12 V C.C.

PIAGGIO: Ape Tm 703

(R.O. 292695)



24 607 0140



6 V C.C.

PIAGGIO 125: Vespa V1T-V15T-V30T-V33T

(R.O. 011635)



24 607 0150



6 V C.C.

PIAGGIO 125-150: Vespa VM1/2-VUU1-VM1/2

(R.O. 020250)



24 607 0160



6 V C.C.

PIAGGIO 150: Vespa VL3-VB1

(R.O. 025714)



24 607 0170



6 V C.C.

PIAGGIO 150: Vespa VL3-VB1

(R.O. 025714B)



24 607 0180



6 V C.A.

PIAGGIO: Vespa 50-90 SS-Nuova 125 V5A1-V55S-V9A1-V9SS-VNB3/4

(R.O. 093753)





CLACSON
HORN

24 607 0190



6 V C.A.

PIAGGIO: Vespa 50N-R-90 SS-Nuova
125-V5A1T-V9SS1T-VMA1T
(R.O. 097828)



24 607 0210



6 V C.C.

PIAGGIO: Vespa 150-GL 150-160 GS-180 SS-
VBA1T-VBB1T-VS2/3/4/5
(R.O. 089840)



24 607 0220



6 V C.C.

PIAGGIO: Vespa 150-GL - 150-160 GS-180 SS-
VBA1T-VBB1T-VS2/3/4/5
(R.O. 089840)



24 607 0230



6 V C.A.

PIAGGIO 50: Ciao • Si • Bravo • Boxer
(R.O. 122232)





MODELLO MODEL	CC	ANNI YEARS	RIF. ORIGINALE OEM NUMBER	CODICE RMS RMS CODE
APRILIA				
Scarabeo	50	93-97	AP8212587	24 607 0020
Rs	50	91-98	AP8224179	24 607 0010
CAGIVA				
City	50	-	-	24 607 0010
Supercity	50	-	-	24 607 0010
GILERA				
Runner	50	97-00	58033R	24 607 0060
Runner Poggiali	50	02	294828	24 607 0060
Runner Purejet	50	02-04	CM071805	24 607 0080
Runner Purejet	50	05-06	CM071802- CM071814	24 607 0110
Runner Sp	50	02-04	294828	24 607 0060
Stalker	50	97-04	CM071804	24 607 0070
Storm Eu2	50	07	CM071803	24 607 0060
Typhoon	50	94-97	58033R	24 607 0060
Typhoon X	50	98-99	58033R	24 607 0060
Typhoon Xr	50	00	58033R	24 607 0060
Nexus Eu3	125	07-08	58034R	24 607 0030
Nexus Eu3 le	125	08-09	58034R	24 607 0030
Runner Fx-Fxr	125	97-02	CM071803	24 607 0060
Runner Vx Vxr	125	02-04	CM071803	24 607 0060
Runner Vx Vxr	125	00-01	CM071803	24 607 0060
Runner Fx-Fxr	180	97-02	CM071803	24 607 0060
Runner Vxr 4T St Eu3	200	08	58034R	24 607 0030
Nexus Eu3	250	06-09	58034R	24 607 0030
Nexus Sp Eu3	250	06-07	58034R	24 607 0030
Fuoco	500	07-09	CM071803	24 607 0060
Nexus Eu3	500	06-09	58034R	24 607 0030
Nexus Sp Eu3	500	06-07	58034R	24 607 0030
Gp	800	08-09	5814401-640474	24 607 0121
HONDA				
Vision	50	-	-	24 607 0010
MALAGUTI				
Ciak Master 4T	50	05-06	01801600	24 607 0010
Ciak Master Euro 2	50	06	01801600	24 607 0010
Ciak Master	50	04	01801600	24 607 0010
Ciak Mono Euro 2.2.3	50	03	01801600	24 607 0010
Ciak Mono Euro 2	50	03	01801600	24 607 0010
FL 0 Ac Eco	50	09-10	01801600	24 607 0010
F10 Ac	50	08	01801600	24 607 0010
F10 Restyling Eu1	50	01-02	01801600	24 607 0010
F10 Restyling Eu2-2.3	50	03-04	01801600	24 607 0010
F10 Restyling Euro2	50	02-03	01801600	24 607 0010
F10 Restyling Euro2	50	06	01801600	24 607 0010
F12 Aria Restyling Eu 2	50	06	01801600	24 607 0010
F12 Lc Restyling Eu 2	50	06	01801600	24 607 0010
F12 Phantom Lc Restyling Eu1	50	01-02	01801600	24 607 0010
F12 Phantom Lc Restyling Eu2-2.3	50	03-04	01801600	24 607 0010
F12 Phantom Lc Restyling Eu2	50	02	01801600	24 607 0010
F12 Phantom Restyling Eu1	50	01-02	01801600	24 607 0010
F12 Phantom Restyling Eu2-2.3	50	03-04	01801600	24 607 0010
F12 Phantom Restyling Eu2	50	02	01801600	24 607 0010
F15 Fire Fox Air Cooled	50	05-06	01801600	24 607 0010

MODELLO MODEL	CC	ANNI YEARS	RIF. ORIGINALE OEM NUMBER	CODICE RMS RMS CODE
F15 Fire Fox Euro2	50	02-03	01801600	24 607 0010
F15 Fire Fox Restyling Euro2-2.3	50	03-04	01801600	24 607 0010
F15 Lc Restyling Eu 2	50	04-05	01801600	24 607 0010
Fly Lc-Tds Restyling Eu1	50	01	01801600	24 607 0010
Ciak Master Euro 3	125	06	01801600	24 607 0010
Ciak Master	125	04	01801600	24 607 0010
Ciak Restyling Euro2	125	03	01801600	24 607 0010
Ciak	125	00-01	01801600	24 607 0010
F18 Warrior	125	00-02	01801600	24 607 0010
Madison R Restyling u2	125	03-04	01801600	24 607 0010
Madison R Restyling	125	02	01801600	24 607 0010
Madison	125	99-01	01801600	24 607 0010
Phantom Max	125	03	01801600	24 607 0010
Ciak Master	150	04	01801600	24 607 0010
Ciak Restyling Euro2	150	03	01801600	24 607 0010
Ciak	150	00-02	01801600	24 607 0010
F18 Warrior	150	00-02	01801600	24 607 0010
Madison T	150	99-01	01801600	24 607 0010
Madison R	180	01-02	01801600	24 607 0010
Ciak Master Euro 2	200	06	01801600	24 607 0010
Madison S Restyling Eu2	200	03	01801600	24 607 0010
Madison S Restyling	200	02	01801600	24 607 0010
Phantom Max	200	03	01801600	24 607 0010
Madison Rs Restyling	250	04	01801600	24 607 0010
Madison S	250	99-01	01801600	24 607 0010
Phantom Max	250	04	01801600	24 607 0010
Madison K Restyling	400	02-04	01801600	24 607 0010
Madison K	400	02	01801600	24 607 0010
Spidermax Gt	500	04-05	01801600	24 607 0010
MBK				
Evolis	50	-	-	24 607 0010
Sorriso	50	-	-	24 607 0010
Booster	50	-	-	24 607 0010
Target	50	-	-	24 607 0010
PEUGEOT				
Rapido	50	-	-	24 607 0010
Sv	50	-	-	24 607 0010
Sv	125	-	-	24 607 0010
PIAGGIO				
Ape FL - FL2	50	89-95	CM071807	24 607 0100
Ape FL3 Europa	50	96-99	CM071807	24 607 0100
Ape Tm P	50	85-89	CM071807	24 607 0100
Ciao - Si	50	-	122232	24 607 0230
Bravo - Boxer	50	-	122232	24 607 0230
FLy 2T	50	05-07	CM071805	24 607 0080
FLy 4T	50	05-08	CM071805	24 607 0080
FLy 4T Mot Chn	50	06-07	CM071805	24 607 0080
Free	50	92-94	CM071803	24 607 0060
Free Delivery	50	00-01	CM071806	24 607 0090
Free FL	50	95-02	CM071803	24 607 0060
Liberty	50	97-05	CM071803	24 607 0060
Liberty 2T	50	06-08	CM071803	24 607 0060
Liberty 2T Rst	50	04	CM071803	24 607 0060
Liberty 2T Sport	50	06-08	CM071803	24 607 0060
Liberty 2T Sport	50	06	CM071805	24 607 0080
Liberty 4T	50	00-02	CM071805	24 607 0080
Liberty 4T	50	05-08	CM071805	24 607 0080



CLACSON HORN

MODELLO MODEL	CC	ANNI YEARS	RIF. ORIGINALE OEM NUMBER	CODICE RMS RMS CODE
Liberty 4T Rst	50	04	CM071803	24 607 0060
Liberty Moc 2T	50	09	CM071803	24 607 0060
Liberty Moc 4T	50	09	CM071805	24 607 0080
Liberty Ptt Eu2	50	04-05	CM071806	24 607 0090
Nrg Power Dd	50	06-09	CM071803	24 607 0060
Nrg Power Dd Serie Spece	50	07-08	CM071803	24 607 0060
Nrg Power Dt	50	07-08	CM071803	24 607 0060
Nrg Power Dt Serie Spece	50	07-08	CM071803	24 607 0060
Nrg Power Purejet	50	06-08	CM071805	24 607 0080
Sfera	50	91-93	CM071801	24 607 0030
Sfera Maquillage 2	50	94	CM071801	24 607 0030
Typhoon	50	01-09	CM071803	24 607 0060
Vespa 50 Spec	50	00	070300	24 607 0040
Vespa Et2	50	97-05	CM071801	24 607 0030
Vespa Et2 Iniezione	50	97-00	CM071801	24 607 0030
Vespa Et4	50	00-05	CM071802- CM071814	24 607 0110
Vespa Lx 2T	50	05-08	CM071802- CM071814	24 607 0110
Vespa Lx 2T FL	50	09-10	CM071802- CM071814	24 607 0110
Vespa Lx 4T	50	05-08	CM071802- CM071814	24 607 0110
Vespa Lxv 2T	50	06-08	CM071802- CM071814	24 607 0110
Vespa S 2T	50	07-08	CM071802- CM071814	24 607 0110
Vespa S 4T-4V	50	08-09	CM071802- CM071814	24 607 0110
Zip	50	92-93	CM071801	24 607 0030
Zip	50	00-04	CM071801	24 607 0030
Zip 2T	50	08-09	CM071801	24 607 0030
Zip 4T	50	00-08	CM071802- CM071814	24 607 0110
Zip Rst	50	96-99	CM071801	24 607 0030
Zip Sp	50	96-00	CM071801	24 607 0030
Zip Sp	50	01-04	CM071804	24 607 0070
Zip Sp Eu2	50	06-09	CM071801	24 607 0030
FLy 4T	100	06-08	CM071805	24 607 0080
Zip 4T	100	06-08	CM071802- CM071814	24 607 0110
Beverly	125	01-03	CM071801	24 607 0030
Beverly Eu3	125	07-08	CM071804	24 607 0070
Beverly Eu3 Mic	125	07	CM071804	24 607 0070
Beverly Eu3 Sport	125	07-08	CM071804	24 607 0070
Beverly Rst	125	06-07	CM071804	24 607 0070
Beverly Tourer Eu3	125	08-09	CM071804	24 607 0070
FLy	125	05-07	CM071805	24 607 0080
FLy Eu3	125	07-08	CM071805	24 607 0080
Hexagon	125	94-97	CM071801	24 607 0030
Hexagon Gtx	125	00	CM071801	24 607 0030
Hexagon Lx-Lxt	125	98-99	CM071801	24 607 0030
Hexagon Lx4	125	98-99	CM071801	24 607 0030
Liberty	125	01-02	CM071803	24 607 0060
Liberty 4T	125	06-07	CM071803	24 607 0060
Liberty 4T Eu3	125	07-08	CM071803	24 607 0060
Liberty 4T Eu3 Delivery	125	08	CM071806	24 607 0090
Liberty 4T Sport Eu3	125	06-08	CM071803	24 607 0060
Liberty Rst	125	04-05	CM071803	24 607 0060

MODELLO MODEL	CC	ANNI YEARS	RIF. ORIGINALE OEM NUMBER	CODICE RMS RMS CODE
Liberty Rst Ptt	125	05-06	CM071806	24 607 0090
Liberty Sport	125	06	CM071803	24 607 0060
Mp3	125	07-08	CM071803	24 607 0060
Mp3 Ie	125	08-09	CM071803	24 607 0060
Skipper	125	94-97	CM071803	24 607 0060
Skipper 4T	125	00-02	CM071803	24 607 0060
Super Hexagon Gtx 12	125	01-02	CM071801	24 607 0030
Vespa Et4	125	96-98	CM071801	24 607 0030
Vespa Et4	125	99-02	CM071801	24 607 0030
Vespa Granturismo	125	03-05	CM071806	24 607 0090
Vespa Granturismo Eu3	125	06-07	CM071806	24 607 0090
Vespa Gts Eu3	125	07-09	CM071806	24 607 0090
Vespa Gtv	125	07-08	CM071806	24 607 0090
Vespa Gtv 4T Navy Eu3	125	08	CM071806	24 607 0090
Vespa Lx	125	05-06	CM071801	24 607 0030
Vespa Lx 4T FL	125	09	CM071801	24 607 0030
Vespa Lx Eu3	125	06-08	CM071801	24 607 0030
Vespa Lxv 4T Eu3	125	06-09	CM071801	24 607 0030
Vespa Lxv 4T Navy Eu3	125	08	CM071801	24 607 0030
Vespa Primavera Et3	125	00	070300	24 607 0040
Vespa Px (s/avv. Elettrico)	125	-	189379	24 607 0050
Vespa Px 30 Anni	125	07-08	CM071807	24 607 0100
Vespa Pxe Arcobaleno	125	81-97	CM071807	24 607 0100
Vespa S 4T Eu3	125	07-08	CM071802- CM071814	24 607 0110
X Evo	125	07	CM071806	24 607 0090
X7 Eu3	125	08	CM071806	24 607 0090
X8	125	04-06	CM071806	24 607 0090
X8 Premium Eu2	125	06	CM071806	24 607 0090
X8 Premium Eu3	125	06-07	CM071806	24 607 0090
X8 Street Eu2	125	06-07	CM071806	24 607 0090
X9	125	01-02	5814401-640474	24 607 0121
X9 Evolution	125	03	5814401-640474	24 607 0121
X9 Evolution	125	05-06	5814401-640474	24 607 0121
X9 Evolution Eu3	125	07	5814401-640474	24 607 0121
Zip	125	00-02	CM071801	24 607 0030
FLy	150	05-07	CM071805	24 607 0080
FLy Eu3	150	08	CM071805	24 607 0080
Liberty 4T Eu3	150	08	CM071803	24 607 0060
Liberty 4T Sport Eu3	150	08	CM071803	24 607 0060
Vespa Lx	150	05-06	CM071801	24 607 0030
Vespa Lx 4T FL	150	09	CM071801	24 607 0030
Vespa Lx Eu3	150	06-08	CM071801	24 607 0030
Vespa Px (s/avv. Elettrico)	150	-	189379	24 607 0050
Vespa S 4T	150	08-09	CM071802- CM071814	24 607 0110
X8 Street Eu2	150	06-08	CM071806	24 607 0090
X9 Amalfi	180	00-03	5814401-640474	24 607 0121
Liberty	200	06	CM071803	24 607 0060
Liberty 4T Eu3	200	07-08	CM071803	24 607 0060
Liberty 4T Sport Eu3	200	06-07	CM071803	24 607 0060
Liberty Rst	200	04	CM071803	24 607 0060
Liberty Sport	200	06	CM071803	24 607 0060
Vespa Granturismo	200	06-07	CM071806	24 607 0090
Vespa Px (s/avv. Elettrico)	200	-	189379	24 607 0050
X8	200	05-07	CM071806	24 607 0090
X9	200	02-03	5814401-640474	24 607 0121



MODELLO MODEL	CC	ANNI YEARS	RIF. ORIGINALE OEM NUMBER	CODICE RMS RMS CODE
X9 Evolution	200	03	5814401-640474	24 607 0121
Ape Car P2-P3	220	78-85	292695	24 607 0130
Ape Mp P501-P601	220	78-96	292695	24 607 0130
Ape Tm P602	220	82-83	292695	24 607 0130
ApeTmP703-P703V,FL2	220	84-05	292695	24 607 0130
Beverly	250	06-07	CM071804	24 607 0070
Beverly Cruiser	250	07-09	CM071802- CM071814	24 607 0110
Beverly Eu3 Mic	250	07	CM071802- CM071814	24 607 0110
Beverly le Eu3	250	06-08	CM071802- CM071814	24 607 0110
Beverly Rst	250	04-05	CM071804	24 607 0070
Beverly Tourer Eu3	250	08-09	CM071802- CM071814	24 607 0110
Hexagon Gt-Gtx	250	98-00	CM071801	24 607 0030
Mp3	250	06-08	CM071803	24 607 0060
Mp3 Lt	250	09	CM071803	24 607 0060
Mp3 Mic	250	08-09	CM071803	24 607 0060
Vespa Gt 60 Eu3	250	06-07	CM071805	24 607 0080
Vespa Gts, Gts Abs	250	05-09	CM071806	24 607 0090
Vespa Gtv	250	06-09	CM071805	24 607 0080
Vespa Gtv 4T Navy Eu3	250	08	CM071805	24 607 0080
X7 Eu3	250	08	CM071806	24 607 0090
X8 Eu3	250	05-08	CM071806	24 607 0090
X9 Evolution	250	04	5814401-640474	24 607 0121
X9 Evolution	250	06	5814401-640474	24 607 0121
Xevo	250	07	CM071806	24 607 0090
Beverly 300 le Tourer	300	09	CM071802- CM071814	24 607 0110
Vespa Gts Super	300	08	CM071805	24 607 0080
Beverly Eu3	400	06-07	CM071804	24 607 0070
Beverly Tourer Eu3	400	08-09	CM071802- CM071814	24 607 0110
Mp3	400	07-08	CM071803	24 607 0060
Mp3 Lt	400	09	CM071803	24 607 0060
Mp3 Mic	400	08-09	CM071803	24 607 0060
X Evo	400	07-09	CM071806	24 607 0090
X8 Eu3	400	06-08	CM071806	24 607 0090
Ape Car- Max Diesel	420	86-96	292695	24 607 0130
Ape Tm P703-P703V Diesel	420	87-04	292695	24 607 0130
Beverly	500	02-04	CM071801	24 607 0030
Beverly	500	05-06	CM071802- CM071814	24 607 0110
Beverly Cruiser	500	07-09	CM071802- CM071814	24 607 0110
Beverly Eu3	500	06-08	CM071802- CM071814	24 607 0110
X9	500	01-02	5814401-640474	24 607 0121
X9 Evolution	500	03-07	5814401-640474	24 607 0121
X9 Evolution Abs	500	06-07	5814401-640474	24 607 0121
YAMAHA				
Ct	50	-	-	24 607 0010
Cr Z	50	-	-	24 607 0010
Beluga	125	-	-	24 607 0010



INTERRUTTORI STOP BRAKE LIGHT SWITCHES

24 614 0030



MBK 50: Ovetto 97-01 • Flipper kat. 99-02
Booster Ng • Ng Eu1 99-02 • Spirit-Eu2 99-02 •
Stunt 00-02 Booster • Booster 01-02
• Nitro 00-02
100: Ovetto 97-01 • Nitro 00-02
125-150: Dodo 00-02 • Thunder 01-02
YAMAHA 50: Why • Why kat. 99-02
Bw's Next g. kat. • Next G.99-02
Bw's Original 99-02 • Bw's r 01 • Aerox • Aerox
R 99-02 • Slider 00-02 • Neo's 99-01
100: Aerox R • Neo's 99-02
125-150: Teo's 00-02 • Maxter 01-02
(R.O. NM5839801000)



24 614 0040



MBK 50: Booster 90-94 • Road 94-95
Track 96-98 • Rocket 97-02 • Ng 95-99 • Spirit
96-00 • Ovetto 97-01 • Ovetto Eu1-2 02-03
• Nitro 97-00 • Flipper 98 • Evolis 92-95
• Fizz 94-95
100-125-150: Ovetto 100 00-02
Skyliner 125 98-02 • 150 00-02
YAMAHA 50: Aerox 97-98 • Aerox R 99-00 •
Why 98 • Why Eu1 99-00 • Spy 95-98
Bw's Original 97-00 • Next Generation 97-99
Neo's 97 02 • Eu2 02
100-125-150: Neo's 100 99-02
Majesty 125 98-02 • 150 00-02



24 614 0050



MALAGUTI 50: F10 • F12 • F15 • Centro
Ciak • Crosser • Yesterday
100: F12 • Ciak
125-150: Ciak • Madison • F18 Warrior
180: Madison R
200: Madison S Restyling • Rest. Eu2
250: Madison S
400: Madison K Restyling



24 614 0160



PIAGGIO-GILERA
50-100-125-150-200-250-300-400-500
(R.O. 583575)



24 614 0070



PIAGGIO 125-150-180: Vespa Sprint
(R.O. 055316)



24 614 0080



Pulsante Nero - Black Button
PIAGGIO 50-125: Vespa 67-82
Vespa Pk 50 - 125 82-84
(R.O. 181878)



24 614 0090



Pulsante Rosso - Red Button
PIAGGIO 50: Vespa FL • FL2 Hp 90-97 • Pk 82-
84 • Pk XL Rush 88-89 • Pk XL 85-88
125: Pk XL 86-89 • Px 98-01 • Px 30 anni 07-08
• Px Eu 2 01-07 • Pxe Arcobaleno 81-97
(R.O. 181881)



24 614 0100



Interuttore Stop contatto a pulsante aperto
Normally open stop switch
Applicazione Varie - *Various applications*

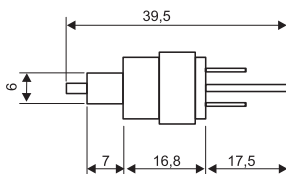

24 614 0110



PIAGGIO 125-150: Vespa • **200:** Super-Rally
VNC1 - VBC1 - VSD1 - VSE - VNL2T - VLD1
VNL3 - VLB1
220: Ape Car P2-P3 78-85 • Ape Mp P501-
P601 78-96
420: Ape Car Max Diesel 86-96 • Ape Poker
Benzina 93 • Ape Poker Diesel 93-97
(R.O. 181637)





24 614 0130



Ø 13 mm

PIAGGIO 50: Ape FL3 Europa 96-99 • Ape Mix 2T 98-08 • Ape Rst Mix 99-03 • Ape 09-16 • Ciao Eu1 99-01 • Ciao Eu2 02-04 • Ciao Mix Teen 96-01 • Free Delivery 00-01 • Free FL 95-02 • Free 92-94 • Liberty 4T 00-02 • Liberty Ptt Eu2 04-05 • Liberty 97-05 • Nrg Extreme 99-00 • Nrg Mc3 01-04 • Nrg Rst Mc2 96-98 • Nrg 94-96 • Ntt 95-96 • Quartz 92-96 • Sfera Maquillage 2 94-94 • Sfera Rst 95-97 • Sfera 91-93 • Si Mix 96-99 • Typhoon 01-04 • Typhoon 05-08 • Velofax 96-99 • Vespa Et2 Iniezione 97-00 • Vespa Et2 97-05 • Vespa Et4 00-05 • Vespa Lxv 2T 06-09 • Zip 2T 08-13 • Zip 4T 00-05 • Zip 4T 06-13 • Zip Bimodale 94-97 • Zip Fast Raider Rst 96-97 • Zip Fast Raider 93-94 • Zip Rst 96-99 • Zip Sp Eu2 06-13 • Zip Sp 96-00 • Zip Sp 01-04 • Zip 92-93 • Zip 95-96 • Zip 00-04 • **80:** Zip 00-04 • Skr City 99-99
100: Zip 00-04 • Skr City 99-99 • Free 02-03 • Zip 4T 06-10
125: Zip 00-04 • Skr City 99-99 • Free 02-03 • Zip 4T 06-10 • Beverly 01-03 • Hexagon Gtx 00-00 • Hexagon Lx-Lxt 98-99 • Hexagon Lx4 98-99 • Hexagon 94-97 • Liberty 98-00 • Liberty 01-02 • Sfera 95-97 • Skipper 4T 00-02 • Skipper Lx 98-99 • Skipper 94-97 • Super Hexagon Gtx 12 01-02 • Typhoon 4T 2V Eu3 10-11 • Vespa Et4 96-98 • Vespa Et4 99-02 • Vespa Gtv 4T Navy Eu3 08-08 • Vespa Gtv 06-08 • Vespa Lxv 4T Eu3 06-09 • Vespa Px Eu2 01-07 • Vespa Px 98-01 • X9 01-02 • Zip 00-02
250: X9 Amalfi 00-03 • Hexagon Gt-Gtx 98-00 • Vespa Gt 60 Eu3 06-07 • Vespa Gtv 06-09 • X7 Eu3 08-08 • X9 00-01
500: X9 Amalfi 00-03 • Hexagon Gt-Gtx 98-00 • Vespa Gt 60 Eu3 06-07 • Vespa Gtv 06-09 • X7 Eu3 08-08 • X9 00-01 • X9 01-02

24 614 0140



INTERRUTTORE STOP UNIVERSALE
(A TIRARE)
STOP SWITCH (PULL)
Modelli Vespa fino al 1957
Vespa Models untill 1957
(R.O. 610200M)



24 614 0150



INTERRUTTORE STOP UNIVERSALE
(A LASCIARE)
STOP SWITCH (RELEASE)
Modelli Vespa fino al 1957
Vespa Models untill 1957
(R.O. 610201M)





INTERMITTENZE - RESISTENZE

INDICATOR INTERMITTENCE - RESISTORS

24 612 0010 

INTERMITTENZA FRECCE
INDICATOR LAMP INTERMITTENCE

12V 21W

PIAGGIO Vespa: Pxe Arcobaleno

125-150-200 81-97 • 50 Pk XL 85-88 • Pk XL
Rush 88-89 • 50 N 89-90 • FL 125 89-00 • Pk 50-
125 82-84 • Px T5 125 85-00 • Pk S Automatica
84-89 • 50 FL 90 • Pxe 125-150-200 88-91
• Ape 50 Tm P 85-89 • Cosa 2 125-200 91-97
• Si 50 FL2 91-97 • Si 50 Mix 96-99
• Cosa CL CLX 125-150-200 88-91
• Ape 50 P 80-85
(R.O. 163968-195703)



24 612 0020 

INTERMITTENZA FRECCE
CON AVVISATORE ACUSTICO
INDICATOR LAMP ACOUSTIC INTERMITTENCE

MBK 50: Booster 01-03 • Ng 99-03

• Ng Eu 99-00 • Spirit 99-00 • Spirit Eu2 02
• Nitro 97-02 • Stunt 00-02 • Nitro 100 00/02

YAMAHA 50: Aerox 97-02 • Aerox R 99-00

• Bw's Original 99-02 • Bw's Original Eu 2 02
• Bw's N.g. 01-03 • Slider 00-02 • Aerox 100 00-02



24 612 0030 

INTERMITTENZA FRECCE
INDICATOR LAMP INTERMITTENCE

MBK 50: Booster Spirit 03 • Booster Spirit Eu2 03
• Booster Naked 03

YAMAHA 50: Aerox Eu2 03 • Bw's Original Eu2
03 • Bw's Original 03 • Bw's Naked 03



24 612 0060 

INTERMITTENZA FRECCE
CON AVVISATORE ACUSTICO
INDICATOR LAMP ACOUSTIC
INTERMITTENCE

MBK 50: Booster Spirit 03 • Booster Spirit Eu2
03 • Booster Naked 03

YAMAHA 50: Aerox Eu2 03 • Bw's Original
Eu2 03 • Bw's Original 03 • Bw's Naked 03



24 612 0072 

INTERMITTENZA FRECCE
CON AVVISATORE ACUSTICO
INDICATOR LAMP ACOUSTIC
INTERMITTENCE

10 W x 2+3,4 W

KYMCO 50: Agility 4t R10 • R12 05-08 • R16 08-12

• Filly 98-02 • Heroism 95-97 • People - Eu2 99-08
• Super 8 07-09 • Yup 02-03 • Super 9 00-04
• Top Boy 97-00

125: Agility 4t 06-08 • Agility R16 09-12 • Grand
Dink 01-04 • Movie 99-07 • People Eu2 99-03 •
Vivio 00

150: Movie Eu2 -Eu 3 04-07 • Agility R16 08-09

200: Agility R16 10-12

250: Grand Dink 01-04 • People Lc 03-04 • Yup 03
(R.O. 00151708 • 00151016 • 00151515)



24 612 0082 

INTERMITTENZA FRECCE
CON AVVISATORE ACUSTICO
INDICATOR LAMP ACOUSTIC
INTERMITTENCE

SYM 50: Dd Eu2 03-07 • Mask 00-01

125: Attila 99-00 • Hd Eu2-3 03-08 • Joyride Eu2 01-04
• Shark 99-02

150: Attila 00-01 • Joyride 01-02 • Shark 00-01

200: Hd Eu 03-04 • Hd Evo Eu2-3 05-07

• Joyride Eu2 03-06 • Joyride 03
(R.O. 38301A31000)

KYMCO 50: Sniper 93 • Sniper Dd 94-96 • Dink Lc
98-02 • Dink Classic Eu2 03

125: Zinc 97-98

200: Dink Classic 04

250: Venox 02-07



24 612 0092 

INTERMITTENZA FRECCE
CON AVVISATORE ACUSTICO
INDICATOR LAMP ACOUSTIC
INTERMITTENCE

KYMCO 50: People S/4T 05-08

125-200-300: People GTI 10

300: X Citing IR 09

500: X Citing R 09

Di primo equipaggiamento - *OEM Quality*
(R.O. 00151701)



24 612 0102 

INTERRUPTORE FRECCE
INDICATOR LAMP INTERMITTENCE

KYMCO 125: Dink Eu3 06-07

250: X Citing I 06-07 • X Citing 05

300: X Citing I R 08 • X Citing I 08

400: Mxu 08

500: Mxu Irs 10 • Mxu 05-06 • Uxv I 10 • Uxv 08

• X Citing R 07-08 • X Citing I 06-08 • X Citing 05
(R.O. 00169143-38300-LBC6-90A)



24 612 0112 

INTERMITTENZA FRECCE
INDICATOR LAMP INTERMITTENCE

MBK 50: Cr Z Target 91-95 • Ct S Sorriso 91-92
• Ct SS Sorriso 93-95 • Ya Ta New Sorriso 95-96

100: Yw Booster 99-01

YAMAHA 50: Cr Z 91-95 • Ct S 90-95 • Ct SS
92-95 • Ya Za Jog Z 95

100: Bw's 91-01

(R.O. 1MHH3350V000)





24 612 0122

INTERMITTENZA FRECCHE

INDICATOR LAMP INTERMITTENCE

KYMCO 125: Downtown i 09 • Gran Dink 12
200: Downtown i 10
300: Downtown i 09-11 • Abs 10 • Abs i 11
• Grand Dink 12
(R.O. 00138013)



24 612 0132

INTERMITTENZA FRECCHE

INDICATOR LAMP INTERMITTENCE

KYMCO 125: People S 05 • People Sd Eu3 07-08
200: People S 05 • People Si 07
250: People S 06 • People Si 07
300: People Si 08
(R.O. 00151709)



24 612 0142

INTERRUTTORE FRECCHE

INDICATOR LAMP INTERMITTENCE

21 Wx2+3.4W
SYM 125: Joyride Evo 09-13
200: Joyride Evo i 09-13
300: Citycom Efi 10-11 • Citycomi Cbs 12
Citycom 08-09 • Quad Lander S 07-08
• Quad Lander 08
(R.O. 38301RFA000)



24 612 0152

INTERRUTTORE FRECCHE

INDICATOR LAMP INTERMITTENCE

10 Wx2+3.4W
KYMCO 50: Dink 4T 07 • Sento 08
125: Quannon 08
200: Dink Eu3 i 06-07
450: Maxxer i 10
(R.O. 00172193)



24 612 0162

INTERRUTTORE FRECCHE

INDICATOR LAMP INTERMITTENCE

KYMCO 125: Quannon Naked 10
400: X Citing i 13
700: Mxu i 13 • Myroad i 11
(R.O. 00138023)



24 640 0100

TELERUTTORE - INDICATOR RELAY

PIAGGIO 50: Ape FL-FL2 89-95 • Sfera Rst 95-97 • Velofax 96-99 • Zip Bimodale 94-97 • Zip Fast Raider 93-94 • Zip 95-96
(R.O. 640289)



24 640 0072

TELERUTTORE - HIGH BEAM RELAY

PIAGGIO 125: Beverly Eu3 Mic 07 • Beverly Rst 04-05 • Beverly 01-03 • Fly 05-07 • Hexagon Gtx 00 • Hexagon Lx-Lxt 98-99 • Hexagon Lx4 98-99 • Hrxagon 94-97 • Liberty 4T Eu3 07-08 • Liberty Rst 04-05 • Liberty 98-02 • Skipper 4T 00-02 • Skipper Lx 98-99 • Super Hexagon Gtx 12 01-02 • Vespa Et4 96-02 • Vespa S 4T Eu3 07-08 • X8 Premium Eu2 06 • X8 Premium Eu3 06-07 • X8 Street Eu2 06-07 • X8 05-06 • X9 Evolution Eu3 07 • X9 Evolution 03-06 • X9 01-02
150: Fly 05-07 • X8 Street Eu2 06-08
180: X9 Amalfi 00-03
200: Liberty Rst 04 • Liberty Sport 06 • X8 05-07 • X9 Evolution 03 • X9 02-03
250: Beverly Eu3 Mic 07 • Beverly le Eu3 06-08 • Beverly Rst 04-05 • Beverly Sport 06-08 • Beverly Tourer Eu3 08-09 • Beverly 06-07 • Hexagon Gt-Gtx 98-00 • X8 Eu3 05-08 • X9 Evolution 04-06 • X9 00-01 • **400:** Beverly Eu3 06-07 • Beverly Tourer Eu3 08-10 • **420:** Ape Car Max Diesel 86-96 • Ape Poker Diesel 93-97 • Ape Tm Diesel Lcs 05-12
500: Beverly Eu3 06-08 • Beverly 02-04 • X9 Evolution 03-05 • X9 Evolution 03-07 • X9 01-02
(R.O. 58002R)





INTERMITTENZE - RESISTENZE
INDICATOR INTERMITTENCE - RESISTORS

24 640 0062 

RELÈ FRECCE - INDICATOR LAMP RELAY

KYMCO 125: Dink Eu3 06-07 • Downtown i 09
• G-Dink 12 • People Gt1 10 • Quannon 08
125-150: B&w Eu2 03-04 • B&w 00 • Grand Dink 01-02 • Grand Dink 01-02
200: Agility R16 10-12 • Dink Classic 04 • Dink Eu3 i 06-07 • Downtown i 10 • Like 01 09 • Like LX 12 • People Gti 10 • People S 01 07
250: B&w Eu2 03 • B&w 00 • Grand Dink Eu2 03-04 • Grand Dink 01-02 • People Lc 03-04 • People S i 07 • Venox Eu3 07 • X Citing i 06-07 • X Citing 05 • Yup 03
300: Downtown i 09 • Downtown Abs i 11 • Downtown Abs 10 • Downtown i 11 • G-Dink 12 • Mxu R 10 • People Gti 10-11 • People S i 08 • X Citing i R 08-09 • X Citing i 08
450: Maxxer i 10
500: Mxu Irs 10 • Mxu 05-06 • Uxv i 10 • Uxv 08 • X Citing R 09 • X Citing i R 07-08 • X Citing i 06-08 • X Citing 05
700: Myroad I 11
(R.O. 00168930)



24 612 9000 

RESISTENZA ELETTRICA 5 W
RESISTOR 5 W

KYMCO
Di primo equipaggiamento - *OEM Quality*
(R.O. 00169731)



24 612 9010 

RESISTENZA - RESISTOR

KIMCO 50: Agility 4T R10 04-08 • R12 05-08
• Filly LX 01-02 • Vitality 4T 04 • Dink 4T 07
Di primo equipaggiamento - *OEM Quality*
(R.O. 00168591)



24 612 9040 

RESISTENZA - RESISTOR

KYMCO 50: Agility 4T R16 08-12 • Agility Rs 09
• Like 4T 09 • Super 8 4T 09 • Super 8 07
(R.O. 00135001 • 35400 • LEJ2-E10)



24 612 9050 

RESISTENZA - RESISTOR

KYMCO 125: Agility R16 08-12 • Like 09
• Super 8 08-09
150: Agility R16 08-09
(R.O. 0135006 • 35400-LEJ3-E10)



RELÈ TEMPORIZZATO PER FARI XENON - TIMER RELAY FOR XENON LIGHTS

Dispositivo che ritarda l'accensione dei fari nella fase all'avvio del motociclo, riducendo al minimo l'assorbimento di energia della batteria, per garantire una maggiore affidabilità nella messa in moto del veicolo.

Il timer chiude il circuito verso le luci 15 o 25 secondi dopo l'accensione del veicolo con interruttore luci in posizione di OFF.

Il dispositivo non è compatibile con motocicli dotati di una singola lampada utilizzata come luce anabbagliante/ abbagliante.

Starting a Motorcycle when the Lights are switched on, will drain power from the Battery very quickly. For optimal power consumption Motorcycles should be started with the Lights switched off.

This timer close the circuit to the Lights 15 or 25 seconds after the ignition is activated by setting the "lights switch" to OFF.

Device not compatible with motorbikes using single bulb serving as low beam/ high beam light.

24 640 0120 

Ritardo 15 secondi
Delay 15 seconds

24 640 0130 

Ritardo 25 secondi
Delay 25 seconds

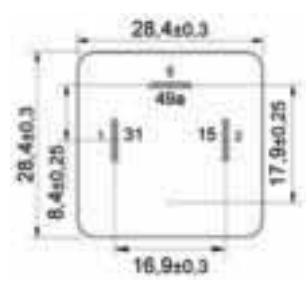
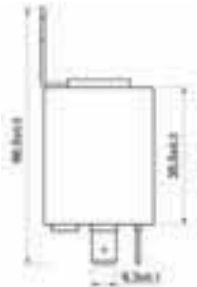
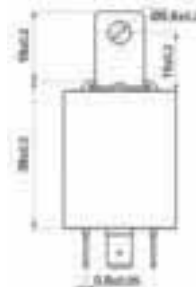

Schede tecniche consultabili sul sito www.rms - *Data sheet available at www.rms.it*



10 012 0030 

INTERRUTTORE TERMICO
TEMPERATURE SWITCH

KYMC0 125: Downtown i 09
125-150: B&w 00 • Dink Classic Eu2 03
200: Downtown i 10 • People Gti 10 • B&w Eu2 03
250: Grand Dink 01-02 • People S i 07
• X Citing i 06-07 • X Citing 05
300: Downtown i 09 • Downtown Abs i 11 •
Downtown Abs 10 • Downtown i 11 • People
Gti 10-11 • People S i 08 • X Citing i R 08-09
500: X Citing R 09 • X Citing i R 07-08 • X Citing
i 06-08 • X Citing 05 • Myroad i 11
(R.O. 0170950-37760-KD8-900)



10 012 0020 

INTERRUTTORE TERMICO
TEMPERATURE SWITCH

KIMCO 50: B&w Eu2 02-03 • Dink Lc 98-02 •
Super 9/Sport Eu2 00-04
125: Dink Eu3 06-07 • Downtown i 09 • People
Gti 10
125-150: B&w Eu2 00-04 • Dink Classic Eu2
02-03 • Dink Lx 98-00 • Gran Dink Eu2 01-04
200: Dink Classic 04 • Dink Eu3 i 06-07 • Down-
town i 10 • People Gti 10
250: B&w Eu2 00-03 • Grand Dink Eu2 01-04
• Kxr 03-04 • Mxu 05 • People Lc/S/S i 03-07 •
Venox Eu2/3 02-07 • X Citing i 05-07 • Yup 03
300: Downtown i Abs 09-10 • Maxxer 05-06 •
Mxu/R 05-10 • People S i/Gti 08-10
• X Citing i/i R 08-09
500: Mxu 05-06 • Uxv 08 • X Citing 05 • R 09
• i R 06-09
SYM 125: Hd Eu2 / Eu3 03-08 • Hd Evo Eu3 •
Tamburo Eu3 07-10 • Joy Ride Eu2 / Eu2/3 03-
07 • Joy Ride Evo 09-10
150: Joy Ride 01-02
200: Hd Evo i Eu3 • Tamburo Eu3 08-10 • Joy
Ride Eu2 05-06 • Joy Ride i Eu3 07-09
250: Gts 07-08 • Joy Max Eu3 i 05-08 • Quad
Lander 06-07
300: Citycom / Ef1 08-10 • Joy Max Evo / Evo i
09-10 • Quad Lander / Lander S 07-08
400: Max Sym i 11
Di primo equipaggiamento - *OEM Quality*
(R.O. 00129966)



10 012 0050 

SENSORE PRESSIONE OLIO
OIL PRESSURE SENSOR

SYM 400: Maxsym 11-12
(R.O. 37240L4A000)



10 012 0060 

SENSORE TEMPERATURA ACQUA - WATER TEMPERATURE SENSOR

APRILIA 125: Rs 06-10 • Sport City One 4T Eu3 08-11 • Sr Motard 12-13 • **850:** Srv - Srv Abs Atc
12-13 • **DERBI 125:** Boulevard 4T Eu3 08-12 • Sonar 4T 09-11 • Variant Sport 4T E3 12 • **150:**
Boulevard 4T E3 10 • Sonar 4T 09
GILERA 500: Fuoco 4T 4V ie E3 Lt 13 • Fuoco Eu3 07-13 • **800:** Gp Centenario 09 • Gp 07-11
PIAGGIO 50: Fly 4T 4V 12-13 • **125:** Beverly Rst 4T 4V ie Eu3 10-13 • Beverly 01-03 • Fly Eu3
07-11 • Hexagon Gtx 00 • Liberty 4T 2V ie Ptt - Ita 12 • Liberty 4T Eu3 Delivery - Single 07-12 •
Liberty 4T Eu3 Delivery Tnt 08-09 • Liberty 4T Eu3 07-08 • Liberty 4T Sport Eu3 06-08 • Mp3 ie
07-08 • Typhoon 4T 2V Eu3 10-11 • Vespa Lx 4T FL 09 • Vespa Lx Eu3 06-08 • Vespa Lxv 4T Navy Eu3
07-08 • Vespa S 4T Eu3 07-08 • X Evo 07-12 • X10 4T 4V ie Eu3 12-13 • X9 Evolution Eu3 07 • X9
Evolution 03-06 • X9 01-02 • 150: Fly Eu3 08-11 • Liberty 4T Eu3 08 • Liberty 4T Sport Eu3 08
• Liberty Moc 4T Eu3 09-13 • Vespa Lx 4T FL 09 • Vespa Lx Eu3 06-08 • Vespa S 4T 08-09 • **180:**
X9 Amalfi 00-03 • **200:** Liberty 4T Eu3 06-08 • Liberty 4T Sport Eu3 06-07 • X9 Evolution 03 • X9
02-03 • **250:** Hexagon Gt-Gtx 98-00 • Mp3 Lt 08-09 • Mp3 Mic 08-09 • Mp3 06-08 • Vespa Gts
Abs 05-12 • Vespa Gts 05-13 • X Evo 07-13 • X9 Evolution 04-06 • X9 00-01 • **300:** Beverly Rst 4T
4V ie Eu3 10-13 • Mp3 ie Lt 10-11 • Mp3 ie Mic 10-11 • Mp3 ie Lt Touring 11-12 • Mp3 ie Lt-ie
Lt Sport 11-13 • Mp3 ie Touring 11-12 • Mp3 Yourban Lt ERL 11-12 • **350:** Beverly 4T 4V ie Eu3
Sport Touring 11-13 • X10 4T 4V ie Eu3 12-13 • **400:** Mp3 ie Lt-Mp3 ie Lt Sport 08-10 • Mp3 ie Lt
Touring 11 • Mp3 Mic 08-10 • Mp3 RL Touring 11 • Mp3 07-08 • X Evo 07-11 • **500:** Mp3 Lt Sport -
Business 11 • Mp3 RL Sport - Business 11-12 • X10 4T 4V ie Eu3 12-13 • X9 Evolution Abs 06-07 •
X9 Evolution 03-07 (R.O. 581142)





SENSORI SENSORS

10 012 0070



SONDA LAMBDA - OXYGEN SENSOR

KYMCO 125: Downtown I 09 • G-Dink 12 • K-Xct I 12-14 • People Gti 10 • People One I Dd 15 • People One I 13
200: Agility R16 10 • Agility I Plus 14 • Agility R16 12 • Dink Eu3 I 06-07 • Like I 09 • Like Lx 12 • People S I 07 • Downtown I 10 • People Gti 10-14 • **250:** People S I 07 • X Citing I 06-07 • **300:** Downtown I 09 • Downtown Abs I 11 • Downtown Abs 10 • Downtown I 11 • G-Dink 12 • People Gti Abs 12-14 • People Gti 10-14 • People S I 08 • X Citing I R 08-09 • X Citing I 08 • K-Xct I Abs 14 • K-Xct I 12 • **350:** Downtown I Abs 15 • **400:** X Citing I Abs 14-15 • X Citing I 13-15 • **500:** X Citing R 09 • X Citing I R 07-08 • X Citing I 06-08
 (R.O. 00168213 • 00168148)



10 012 0080



SONDA LAMBDA - OXYGEN SENSOR

APRILIA 125: Sr Max 11-14 • **250:** Sport City Cube 08-12 • **300:** Atlantic 10-11 • Scarabeo Light 09-10 • Sport City Street 12 • Sr Max 11-14 • 400: Atlantic Sprint 05-08 • Scarabeo Light 06-08 • **850:** Srv - Srv Abs Atc 12-14
GILERA 125: Nexus Eu3 ie 08-10 • **300:** Nexus Eu3 08-11 • **500:** Fuoco 4T 4V ie Eu3 Lt 13-14 • Fuoco Eu3 07-13-11 • Nexus Eu3 06-11 • Nexus Sp Eu3 06-07
PIAGGIO 125: Beverly Rst 4T 4V ie Eu3 10-15 • Mp3 Ibrido 09-10 • Mp3 ie Touring 11-12 • Mp3 ie 08-09 • Vespa Gts 4T ie Super 09-16 • X10 4T 4V ie Eu3 12-13 • X7 Evo ie Eu3 09-10 • **300:** Beverly Rst 4T 4V ie Eu3 10-15 • Beverly Tourer Eu3 09-10 • Carnaby Cruiser 09-12 • Mp3 ie Lt 10-11 • Mp3 ie Mic 10-11 • Mp3 Lt Business - Sport Abs -Enjoy 14-15 • Mp3 4T 4V ie ERL Ibrido 10-13 • Mp3 4T 4V ie Lt Ibrido 10-11 • Mp3 ie Lt Touring 11-13 • Mp3 ie Lt - ie Lt Sport 11-13 • Mp3 ie Touring 11-12 • Mp3 You-rban Lt ERL 11-12 • X7 Evo ie Eu3 09-10 • **350:** Beverly 4T 4V ie Eu3 Sport Touring 11-14 • X10 4T 4V ie Eu3 12-13 • **400:** Beverly Eu3 06-07 • Beverly Tourer Eu3 08-10 • Mp3 ie Lt - Mp3 ie Lt Sport 08-10 • Mp3 ie Lt Touring 11 • Mp3 Mic 08-10 • Mp3 RL Touring 11 • Mp3 07-08 • X Evo 07-11 • X8 Eu3 06-08 • **500:** Beverly Cruiser 07-12 • Beverly Eu3 06-08 • Mp3 Lt Business Abs 14-16 • Mp3 Lt Sport - Business 11-13 • Mp3 RL Sport - Business 11-12 • Mp3 Sport Abs 14-15 • X10 4T 4V ie Eu3 12-14
 (R.O. 6411235 • 639806)



10 012 0090



SONDA LAMBDA - OXYGEN SENSOR

APRILIA 250: Sport City Cube 08-12 • **850:** Mana Gt 09-15 • Mana 07-11 • **1000:** Rsv4 Aprc R Abs 13-14 • Rsv4 Aprc R 11-12 • Rsv4 Factory - Sbk Racing 09-10 • Rsv4 Factory Aprc Abs 13-14 • Rsv4 Factory Aprc Std Se 11-12 • Rsv4 R 09-10 • Tuono V4 R Aprc Abs 14 • Tuono V4 R Std - Aprc 11-13 • Tuono V4 Factory 15 • Tuono V4 Rr 15
GILERA 250: Nexus Eu3 06-07 • Nexus Sp Eu3 06-07 • **800:** Gp Centenario 09 • Gp 07-11
PIAGGIO 125: Liberty 4T 2V ie Ptt - Ita 12 • Vespa Lx 4T Eu3 Touring 10-11 • Vespa Lx Eu3 ie 09-11 • Vespa Lxv ie 4T 10-13 • Vespa S 4T ie & College 09-11 • **150:** Vespa Lx Eu3 ie 09-11 • Vespa Lx Touring 10-12 • Vespa S 4T ie & College 09-12 • **250:** Beverly Cruiser 07-09 • Beverly Eu3 Mic 07 • Beverly ie Eu3 06-08 • Beverly Sport 06-08 • Beverly Tourer Eu3 07-09 • Carnaby 08 • Mp3 Lt 08-09 • Mp3 Mic 08-09 • Mp3 06-08 • Vespa Gt 60 Eu3 06-07 • Vespa Gts Abs 05-12 • Vespa Gts 05-14 • Vespa Gtv 4T Navy Eu3 07 • Vespa Gtv 06-09 • X Evo 07-13 • X7 Eu3 08 • X8 Eu3 05-08
 (R.O. 584344)





24 615 1000 

Kit 10 fusibili lamellari standard
10 Pcs standard fuses kit



24 615 1010 

Kit 10 fusibili lamellari mini
10 Pcs mini fuses kit



24 615 1020 

Kit 10 fusibili siluro
10 Pcs Stc fuses kit



24 615 1030 

Kit 100 fusibili lamellari standard
100 Pcs standard fuses kit



24 615 1040 

Kit 100 fusibili lamellari mini
100 Pcs mini fuses kit





RMS

YOUR BEST PARTNER

▶ CENTRALINE

CDI UNITS

▶ REGOLATORI

REGULATORS

▶ MOTORINI
AVVIAMENTO

STARTER MOTORS

▶ BOBINE

COILS

▶ STATORI E VOLANI

STATORS AND MAGNETOS

▶ **RMS**
YOUR BEST PARTNER

▶ **BERU**



CENTRALINE ELETTRONICHE
ELECTRONIC IGNITION - CDI

APRILIA

24 604 0122

125: Scarabeo Light 07-08
(R.O. JC32900X92000)
Di primo Equipaggiamento – *OEM Quality*



BETA

24 604 0102

125-150: Elkon 00-02
(R.O. 1241850000)



HONDA

24 604 0112

5 Pin
50: Sh >95



KYMCO

24 604 0022

50: Mxu 06-07 • Mxu Sr 06 • People 04 • People 99-00 • People Eu2 08 • People Eu2 03 • People S 05-08
(R.O. 169303)
Di primo Equipaggiamento – *OEM Quality*



24 604 0032

125-150: People 99-00 • People Eu2 03
(R.O. 169397)
Di primo Equipaggiamento – *OEM Quality*



24 604 0042

125: Movie 99-00 • Vivio 00
150: Vivio 00
(R.O. 168187)
Di primo Equipaggiamento – *OEM Quality*



24 604 0052

250: B&W 00 • B&W Eu2 03 • Grand Dink 01-02 • Grand Dink Eu2 03-04
(R.O. 168934)
Di primo Equipaggiamento – *OEM Quality*



24 604 0072

50: Agility 4T R10 06 • Agility R12 05 • Vitality 4T 04
(R.O. 169082)
Di primo Equipaggiamento – *OEM Quality*



24 604 0082

8 Pin
50: Agility 4T R16 08-09 • Agility Rs 09 • Like 4T 09 • Super 8 07 • Super 8 4T 09
(R.O. 130005)
Di primo Equipaggiamento – *OEM Quality*





KYMCO

24 604 0092



8 Pin

125: Agility R16 08-09 • Agility Rs 09 • Like 09
• Super 8 08-09

150: Agility R16 08-09
(R.O. 130008)

Di primo Equipaggiamento – *OEM Quality*



24 604 0102



125: B&w 00 • B&w Eu2 03-04 • Dink 125-150 97-98 • Dink Classic 02 • Dink Classic Eu2 03
• Dink Lx 125-150 98-00 • Grand Dink 01-02
• Grand Dink Eu2 03-04

150: B&w 00 • B&w Eu2 03-04 • Dink 97-98
• Dink Classic 02 • Dink Classic Eu2 03 • Dink Lx
98-00 • Grand Dink 01-02 • Grand Dink Eu2 03-04
(R.O. 168923)

Di primo Equipaggiamento – *OEM Quality*



24 604 0112



5 Pin

50: Djx – Djy

Di primo Equipaggiamento – *OEM Quality*



24 604 0142



50: People S 4T 06-08
(R.O. 101093)

Di primo Equipaggiamento – *OEM Quality*



24 604 0152



125: Agility 4T Eu3 06-08
(R.O. 168168)

Di primo Equipaggiamento – *OEM Quality*



24 604 0162



50: Dink Classic Eu2 98-02 • Super 9 00
• Super 9 Sport Eu2 03-04

(R.O. 1168900)

Di primo Equipaggiamento – *OEM Quality*



24 604 0172



50: Cx Super 94-97 • Cx 93 • Dj W 94-00
(R.O. 00160401 • 30400-KLE-000)

Di primo Equipaggiamento – *OEM Quality*



24 604 0182



50: Agility 2T R16 10 • Agility Rs Naked 2T 09 •
Like 2T 09 • Super 8 2T 09-13

(R.O. 00130025 • 30410-LB3-E10)

Di primo Equipaggiamento – *OEM Quality*



24 604 0192



125: People S DD Eu 3 07-08

(R.O. 00169185 • 30400-LCD3-E10))

Di primo Equipaggiamento – *OEM Quality*





CENTRALINE ELETTRONICHE
ELECTRONIC IGNITION - CDI

KYMCO

24 604 0202



200: Dink Classic 04
(R.O. 00168060 • 30400-LBF6-E00)
Di primo Equipaggiamento – *OEM Quality*



24 604 0212



125-200: People S 05
(R.O. 00169220 • 30400-LCD4-E10)
Di primo Equipaggiamento – *OEM Quality*



MALAGUTI

24 604 0032



125-150: Ciak 00-01 • Ciak Master 04
• Ciak Rst Eu2 03
(R.O. 2406500)
Di primo Equipaggiamento – *OEM Quality*



24 604 0102



125-150: F18 Warrior 00-02
(R.O. 2407500)
Di primo Equipaggiamento – *OEM Quality*



PEUGEOT

24 604 0112



5 Pin
50: SC LI Metropolis • ST Rapido • SV • Geo
• Buxy • Zenith • Squab • Speedake • Ludix
• Trekker • Vivacity (s/antif.eletr.) • Looxor
• Speedfight • LC/Cat. (s/antif.eletr.) • X-Fight
Air (s/antif.eletr.) • Metal-X
100 Speedfight (s/antif.eletr.) • Trekker • SV
(R.O.740220 • 737615 • 709205)
Di primo Equipaggiamento – *OEM Quality*



24 604 0132



6 Pin
50: V-Clic 4T (QM50QT-6-07-09)
Scooter Cinesi - Chinese Scooter
Buffalo QM50QT-6A(A)
Qingqi QM Qt-2 4T (LAEABZ400-07-09)-
QM50QT-6A 4T (LAEABZ400-07-09) QM50QT-
6A) 4T (LAEAGZ400-07-09)-QM50T-6A(A)
4T (LAEAKA10-07-09) Rex Tribal Scooter
4T (07-09)-Off Limit 4T (07-09)-QM50QT-2
Capriolo 4T (07-09) QM50QT-6A RS 450 5T
(06-09)- QM50QT



PGO

24 604 0112



5 Pin
50-100: Scooter 2T Bigmax G • Max T w
• Rex PMX





SYM

24 604 0012



100: Cinderella 99-01
125: Attila 99-00 • Euro Mx 02 • Euro Mx E2 03-04 • Fiddle li 08-10 • Jet4 09 • New Duke 00-01 • Shark 99-02 • Super Duke 99-02 • Symphony 09 • Symphony D.D. 09 • Symphony S 10 • Symphony Sr 10 • Symply 07-08
150: Attila 00-01 • Euro Mx 02 • Euro Mx Eu2 03-04 • Fiddle li 10 • Shark 00-01 • Symphony 09 • Symphony S 10 • Symphony Sr 10
(R.O. 30410M92000)
Di primo Equipaggiamento – *OEM Quality*



24 604 0062



125: Joyride Eu2 03-06 • Joyride Eu3 07 • Joyride Evo 09
200: Joyride 03 • Joyride Eu2 03-04 • Joyride Eu2 05-06
(R.O. 30400H9A000)
Di primo Equipaggiamento – *OEM Quality*



24 604 0222



50: Mio 06-09
(R.O. 30410A1A910)
Di primo Equipaggiamento – *OEM Quality*





RELÈ AVVIAMENTO
STARTER RELAY

RELE' AVVIAMENTO - STARTER RELAY

24 640 0022



RELE' AVVIAMENTO - STARTER RELAY

KIMCO 50: B&w Eu2 02-03 • CX-CX Super 93-97 • DJW-X-Y 91-00 • Dink Lc 98-02 • Dink Classic Reuro 2 02 • Fever ZX Eu2 99-04 • Filly 98-00 • Hero ISM 95-97 • K12-KB 95-00 • People S 05-08 • Sniper-DD 93-94 • Super 9-Sport Eu2 00-04 • Top Boy 97-00 • Yup 02
(R.O. 00168795 • 00169208)

Di primo Equipaggiamento – *OEM Quality*



24 640 0012



RELE' AVVIAMENTO - STARTER RELAY

12V/100A
KIMCO 125: Agility Plus E4 16 • Agility Plus 14 • Agility R16 08-12 • Agility Rs 09 • B&w 125-150 Eu2 03-04 • B&w 125-150 00 • Dink Eu3 06-07 • Grand Dink 125-150 Eu2 03-04 • Grand Dink 125-150 01-02 • Like Lx 12 • Like 09 • Super 8 08-09 • **150:** Agility R16 08-09 • **200:** Agility 2001 R16 10 • Agility I Plus 14 • Agility R16 12 • Dink Eu3 i 06-07 • Like 2001 09 • Like Lx 12 • **250:** Grand Dink Eu2 03-04 • Grand Dink 01-02 • People Lc 03-04
(R.O. 00168997)

MALAGUTI 125: Ciak Master Euro 3 05
Ciak/Restyling Euro 2 Master

125-150 00/04-F18 Warror

125/150 00/02

(R.O. 02503700)

Di primo Equipaggiamento – *OEM Quality*



24 640 0082



RELE' AVVIAMENTO - STARTER RELAY

SUZUKI 250: Burgman W-K2.K3-K6 98-06
400: Burgman X-K2-K3-K6-K7 Lo-L1-L2-L3 99-13
600: Gsx W-K3-K4-K6 99-06
650: Sv X-K2 99-02
750: Gsx W -K1-K3-K4-K6 99-06
800: VL Intruder - Volusia K1-K5-C-K6-Lo-L1-L3 01-13 • Vz Intruder M 800 K5-K9 -L0-L1-L3 05-13 • Vz Marauder V-K2 97-02
900: Rf-Rr-T 94-96
1000: TL S-Su-K1 97-01 • TLR W-Y 98-00
1200: Gsx - X- K1 99-01
1500: VL Intruder Lcw-K3 98-03 • Lc-K5-K8 05-08
(R.O. 31800-21E20-000)



24 640 0052



RELÈ AVVIAMENTO - STARTER RELAY

KYMCO 50: Filly 01-02 • Vitality 4T 04
(R.O. 00169999 • 38500-KDK-900)



24 640 0090



24 640 0093



TELERUTTORE - STARTER RELAY

PIAGGIO 125-150-200: Vespa PX • PXE Arcobaleno-T5 VNX2-VLX1-VSX1-VNX5T
(R.O. 218824)



24 640 0143



RELAIS - RELAIS

PIAGGIO 125: Vespa Px 30 anni 07-08 • Vespa Px Eu2 01-07 • Vespa Px 98-16
150: Vespa Px 11-16 VNX-VLX-VSX
(R.O. 233707)





24 640 0110



TELERUTTORE - STARTER RELAY

PIAGGIO 50: Ape Mix 2T 98-08 • Ape Rst Mix 99-03 • Ape 09 • Diesis 01 • Fly 2T 05-11 • Fly 4T & 25-30 Km/h 08-11 • Fly 4T 2V 25-30 Km/h 12 • Fly 4T 2V 13 • Fly 4T 2V 12-13 • Fly 4T Motore Chn 06-07 • Fly 4T 05-07 • Free Delivery 00-01 • Free FL 95-02 • Free 92-94 • Liberty 2T Rst 04 • Liberty 2T Sport 06-08 • Liberty 2T 06-08 • Liberty 4t Delivery - Single 10-12 • Liberty 4t Delivery Tnt 09 • Liberty 4T Ptt /Deu) 07-12 • Liberty 4T Ptt - Double 09-12 • Liberty 4T Rst 04 • Liberty 4T Sport 06-08 • Liberty 4T 00-08 • Liberty Moc 2T & Elle 09-13 • Liberty Moc 4T & Elle 09-13 • Liberty Ptt Eu2 04-05 • Liberty 97-05 • Nrg Extreme 99-00 • Nrg Mc3 01-04 • Nrg Power Dd Serie Speciale 07-12 • Nrg Power Dd 0513 • Nrg Power Dt Serie Speciale 07-08 • Nrg Power Dt 06-11 • Nrg Purejet 04-11 • Nrg Purejet 02-10 • Nrg Rst Mc2 96-98 • Nrg 94-96 • Ntt 95-96 • Puch P1-Tre 93-98 • Quartz 92-96 • Sfera Maquillage 2 94 • Sfera Rst 95-97 • Sfera 91-93 • Typhoon 2T Eu2 10-12 • Typhoon 01-11 • Velofax 96-99 • Vespa Et2 iniezione 97-00 • Vespa Et2 97-05 • Vespa Et4 00-05 • Vespa Lx 2T Touring & 30 Km10-13 • Vespa Lx 2T 05-13 • Vespa Lx 4T-4V Touring 10-13 • Vespa Lx 4T-4V 09-13 • Vespa Lx 4T 05-08 • Vespa Lxv 2T Navy 08 • Vespa Lxv 2T 06-09 • Vespa Primavera 2T 13-14 • Vespa Primavera 4T-4V 13-14 • Vespa S 2T & College 07-12 • Vespa S 4T-4V & College 08-12 • Vespa Sprint 2T 2V 14-14 • Vespa Sprint 4T 4V 14-14 • Zip 2T 08-13 • Zip 4T 00-13 • Zip Bimodale 94-97 • Zip Fast Raider Rst 96-97 • Zip Fast Raider 93-94 • Zip Rst 96-99 • Zip Sp Eu2 50 2006-2013 • Zip Sp 96-04 • Zip 92-04 • **80:** Skr City 99-99 • **100:** Fly 4T 06-07 • Fly 4T 08-08 • Free 02-03 • Zip 4T 06-10 • **125:** Beverly Euro 3 Mic 07-07 • Beverly Eu3 Sport 07-08 • Beverly Eu3 07-08 • Beverly Rst 4T 4V ie Eu3 10-13 • Beverly Rst 04-07 • Beverly Tourer Eu3

07-10 • Beverly 01-03 • Carnaby 07-10 • Fly 4T 3V ie E3 Dt 13-13 • Fly 4T 3V ie Eu3 Lem 12-13 • Fly Eu3 07-11 • Fly 05-07 • Hexagon Gtx 00-00 • Hexagon Lx-Lxt 98-99 • Hexagon Lx4 98-99 • Liberty 4T 2V Eu3 09-12 • Liberty 4T 2V ie Ptt - Ita 12-12 • Liberty 4T 3V ie E3 13-14 • Liberty 4T Eu3 Delivery - Single 07-12 • Liberty 4T Eu3 Delivery - Tnt 08-09 • Liberty 4T Eu3 07-08 • Liberty 4T Sport Eu3 06-08 • Liberty 4T 06-07 • Liberty Rst Ptt 05-11 • Liberty Rst 04-05 • Liberty Sport 06-06 • Liberty 98-02 • Mp3 Ibrido 09-10 • Mp3 ie Touring 11-12 • Mp3 ie 08-09 • Mp3 Yourban ERL 11-12 • Mp3 06-08 • Skipper 4T 00-02 • Skipper Lx 98-99 • Super Hexagon Gtx 12 01-02 • Typhoon 4T 2V Eu3 10-11 • Vespa Et4 96-02 • Vespa Granturismo Eu3 06-07 • Vespa Granturismo 03-07 • Vespa Gts 4T ie Super 09-13 • Vespa Gts Eu3 07-12 • Vespa Gtv 4T Navy Eu3 08-08 • Vespa Gtv 06-08 • Vespa Lx 4T 3V ie Touring 12-13 • Vespa Lx 4T Eu3 Touring 10-11 • Vespa Lx 4T FL 09-09 • Vespa Lx Eu3 ie 09-11 • Vespa Lx Eu3 06-08 • Vespa Lx Primavera 4T 3V ie 13-13 • Vespa Lx 05-06 • Vespa Lxv 4T Eu3 06-09 • Vespa Lxv 4T Navy Eu3 07-08 • Vespa Lxv ie 4T 10-13 • Vespa Px 30 Anni 07-08 • Vespa Px Eu2 01-07 • Vespa Px 98-13 • Vespa S 4T 3V ie 12-12 • Vespa S 4T Eu3 07-08 • Vespa S 4T ie & College 09-11 • Vespa Sprint 4T 3V ie 14-14 • X Evo 07-12 • X7 Eu3 08-08 • X7 Evo ie Eu3 09-10 • X8 Premium Eu2 06-06 • X8 Premium Eu3 06-07 • X8 Street Eu2 06-07 • X8 04-06 • X9 Evolution Eu3 07-07 • X9 Evolution 03-06 • X9 01-02 • Zip 00-02 • **150:** Fly Eu3 08-11 • Fly 05-07 • Liberty 4T Eu3 08-08 • Liberty 4T Sport Eu3 08-08 • Liberty Moc 4T Eu3 09-13 • Vespa Lx 4T 3V ie - Touring 12-13 • Vespa Lx 4T FL 09-09 • Vespa Lx Eu3 ie 09-11 • Vespa Lx Eu3-4 06-08 • Vespa Lx Touring 10-12 • Vespa Lx 05-06 • Vespa Primavera 4T-3V 13-13

• Vespa 11-13 • Vespa S 4T ie & College 09-12 • Vespa S 4T 08-09 • X8 Street Eu2 06-08 • **180:** X9 Amalfi 00-03 • **200:** Carnaby 07-08 • Liberty 4T Eu3 06-08 • Liberty 4T Sport Eu3 06-07 • Liberty Rst 04-04 • Liberty Sport 06-06 • Liberty 06-06 • Vespa Granturismo 06-07 • X8 05-07 • X9 Evolution 03-03 • X9 02-03 • **250:** Beverly Cruiser 07-09 • Beverly Eu3 Mic 07-07 • Beverly ie Eu3 06-08 • Beverly Rst 04-05 • Beverly Sport 06-08 • Beverly Tourer Eu3 08-09 • Beverly 06-07 • Carnaby 08-08 • Mp3 Lt 08-09 • Mp3 Mic 08-09 • Mp3 06-08 • Vespa Gt 60 Eu3 06-07 • Vespa Gts Abs 05-12 • Vespa Gts 05-13 • Vespa Gtv 4T Navy Eu3 07-07 • Vespa Gtv 06-09 • X Evo 07-13 • X7 Eu3 08-08 • X8 Eu3 05-08 • X9 Evolution 04-04 • X9 Evolution 06-06 • **300:** Beverly Rst 4T 4V ie Eu3 10-14 • Beverly Tourer Eu3 09-10 • Carnaby Cruiser 09-12 • Mp3 ie Lt 10-11 • Mp3 ie Mic 10-10 • Mp3 ie Mic 11-11 • Mp3 4T 4V ie ERL Ibrido 10-13 • Mp3 4T 4V ie Lt Ibrido 10-11 • Mp3 ie Lt Touring 11-12 • Mp3 ie Lt - ie Lt Sport 11-13 • Mp3 ie Touring 11-12 • Mp3 Yourban ERL 11-11 • Mp3 Yourban Lt ERL 11-12 • Vespa Gts ie Touring 11-12 • Vespa Gts ie 12-13 • Vespa Gts Super Sport 10-13 • Vespa Gts Super 08-13 • Vespa Gtv 4T 4V ie 10-13 • Vespa Gtv Via Montenaepoleone 10-10 • X7 Evo ie Eu3 09-10 • **420:** Ape Tm Diesel Lcs 05-12 • **500:** Quargo 05-12 • X9 Evolution Abs 06-07 • X9 Evolution 06-07 • X9 01-02 • **1200:** Porter D120 E5 11-13 • **1300:** Porter Multitech Eu4 - Eu5 10-13 • Porter Up-Date 09-09 • **1400:** Porter Pick Diesel 98-05 (R.O. 58115R)





CENTRALINE - BOBINE COILS

APRILIA

24 601 0040 

50: Amico GL-GLE • Amico Lx- Sport-Cat 92-93
• Amico 94-98 • Gulliver 95-98 • Gulliver Lc 96-98
• Rally Liquid Cooled 96-99 • Rally 95-03 • Scarabeo 93-05
• Sonic Gp 98-08 • Sonic 98-07
• Sr Liquid Cooled 94-96 • Sr Stealth, Racing 97-99
• Sr Www 97-01 • Sr 93-96
(R.O. AP8206125)



24 601 0092 

125-150: Leonardo 96-01
(R.O. AP0265417)
Di primo Equipaggiamento – *OEM Quality*



24 601 0102 

50: Mojito 04-08 • Scarabeo Street 2T Rst 06-09
• Scarabeo 2T Net 09-10 • Sport City One 2T 08-10
• Sr R Factory ie e Carburatore 10-11 • Sr R R Factory 04-09
• Sr Street 03-08 • Scarabeo Street 05-06
(R.O. 58095R)
Di primo Equipaggiamento – *OEM Quality*



24 601 0122 

50: Mojito 99-03 • Mojito Custom 93-03
• Mojito Retro 93-03 • Sr H2O Ditech e Carburatore 00-03
Di primo Equipaggiamento – *OEM Quality*



24 601 0132 

50: Scarabeo 4T 4V Net 09-10 • Scarabeo 4T 4V 10-12
• Scarabeo Quattro 09
125: Atlantic Eu3 06-08 • Sport City Eu3 06-08
• Sr Max 11
250: Sport City Cube 08-10 • Scarabeo Light 06-08
300: Atlantic 10-11 • Scarabeo Light 09-10
• Sport City Street 12 • Sr Max 11-13
400: Atlantic Sprint 05-08 • Scarabeo Light 400-500 06-08
500: Atlantic 01-04 • Scarabeo 03-06
Di primo Equipaggiamento – *OEM Quality*



24 601 0490 

Non limitata - *No power limitation*

24 601 0491 

Limitata - *Power limitation 8000RPM*
50: Scarabeo 4T Restyling Eu3 06-09
• Scarabeo 4T 02-06
(R.O. AP8224487)



BENELLI

24 601 0501 

Limitata - *Power limitation 11000RPM*
100: Scarabeo 4T 01-05
(R.O. AP8127310)



24 601 0040 

50: 491 Gt 98-99 • 491 Rr 98-01 • 491 Sp 99 • 491 Sport 98-99
• 491 St • K2 Liquid Cooled 99-01 • K2 98-01 • Naked 02 • Pepe Lx 03-04 • Pepe 99-01
(R.O. R51240011A0)



24 601 0082 

125-150: Adiva 01-02
(R.O. R5124013A0)
Lunghezza cavo 40 cm - *Cable lenght 40 cm*





BETA

24 601 0030

50: Ark Air 96-07 • Ark Lc Serie K 04-07 • Ark Lc 96-03 • Quadra Chrono 502 95-99 • Tempo 96-99
(R.O. 1120670000)



DERBI

24 601 0102

50: Boulevard 2T 09 • Variant Sport 2T 12
(R.O. 58095R)
Di primo Equipaggiamento – *OEM Quality*

24 601 0132

125: Rambla Eu3 2Ver 08 • Rambla 08-09
250: GP1 Low Seat Eu3 07-08
250: Rambla Eu3 2Ver 08 • Rambla 08-09
300: Rambla 10-11
Di primo Equipaggiamento – *OEM Quality*

24 601 0490

24 601 0491

50: Atlantis 4T 04-06
(R.O. 969383)

24 601 0501

100: Atlantis 4T 04-06
(R.O. 969896)



GILERA

24 601 0010

50: Easy Moving 95-96 • Storm 94-95
• Typhoon 94-97
(R.O. 826115)

24 601 0072
24 601 0070

50: Stalker 97-04
(R.O. 638678)

24 601 0102

50: Dna 05-07 • Runner Sp 05-07 • Runner Sp Spec Edition 07 • Runner Sp St & Simoncelli 08-09 • Stalker 97-11 • Stalker Naked 08 • Stalker Spec Edition 07-08 • Storm Eu2 07 • Runner Sp 10 v Dna 00-02 • Dna Gp Experience 03-04 • Ice 01-05 • Runner Poggiali 02 • Runner Sp 02-04
(R.O. 58095R)
Di primo Equipaggiamento – *OEM Quality*





CENTRALINE - BOBINE

COILS

GILERA

24 601 0082 

125-200: Runner Vx-Vxr 02-04
(R.O. 829337)
Lunghezza cavo 40 cm - *Cable lenght 40 cm*



24 601 0132 

125: Nexus Eu3 ie 08-10
250: Nexus 03 07 • Nexus Eu3 06 • Nexus Sp Eu3 06-07
300: Nexus Eu3 08-11
500: Nexus Eu3 06-11 • Nexus Sp Eu3 06-07
Nexus 03-05
Di primo Equipaggiamento - *OEM Quality*



HONDA

24 601 0082 

50: Sj Bali 93-> • Gp Dio 91-> • Sh 91-96 • Sfx V 95->
100: Sj Bali 96-99 • Sh 96-99
125: Chiocciola 00-06 • Dylan 01-06 • Sh 125 01-08
150: Chiocciola 00-06 • Dylan 01-06 • Sh 150 01-08
(R.O. 30510-GW2-000)
Lunghezza cavo 40 cm - *Cable lenght 40 cm*



KYMCO

24 601 0092 

250: Grand Dink Eu2 03-04 • Grand Dink 01-02
(R.O. 168940)
Di primo Equipaggiamento - *OEM Quality*



24 601 0152 

200: Dink Eu 3 I 06-07
(R.O: 0169238-3051A-LEA6-900)
Di primo Equipaggiamento - *OEM Quality*



24 601 0172 

200: Agility R16 10 • Agility R16 12
• Like I 09 Like Lx 12
(R.O: 00130026)
Di primo Equipaggiamento - *OEM Quality*



MALAGUTI

24 601 0030 

50: Centro Base 93-94 • Centro SL Kat 99-00 • Centro SL 94-98 • Ciak Mono Eu2 03 • Ciak Td 00-01 • Ciak 99-00 • F10 Jet Line 92-98 • F10 Kat 99-00 • F10 Rst Eu1 01-02 • F10 Rst Eu2 02-03 • F12 Phantom Eu1 99-00 • F12 Phantom Lc Eu1 99-00 • F12 Phantom Lc Rst Eu1 01-02 • F12 Phantom Lc Twin Disks 98 • F12 Phantom Lc 94-98 • F12 Phantom Rst Eu1 01-02 • F12 Phantom Rst Eu2 02 • F12 Phantom 94-98 • F15 Fire Fox Twin Disks & Spec 98-99 • F15 Fire Fox Twin Disks Digit Kat 98-00 • F15 Fire Fox 96-98 • F15 Lc-Tds Rst Eu1 01 • Yesterday • Yesterday Eu 97-00
(R.O. 2403300)



24 601 0040 

50: Centro SL 94-98 • F10 Jet Line 92-98
(R.O. 2403000)



24 601 0082 

125: Madison 3 06-09
180: Madison R 01-02
200: Madison S Rst Eu2 03 • Madison S Rst 02 • Phantom Max 03
250: Madison Rs Rst 04 • Phantom Max 04
(R.O. 2410400)
Lunghezza cavo 40 cm - *Cable lenght 40 cm*





MALAGUTI

24 601 0092



250: Madison S 99-01

(R.O. 2404800)

Di primo Equipaggiamento – *OEM Quality*

24 601 0132



250: Madison 3 06-09

500: Spidermax Gt 04-05 • Spidermax Gt Eu3 06

(R.O. 2412300)

Di primo Equipaggiamento – *OEM Quality*

MBK

24 601 0040



50: Cw Booster Naked 03 • Cw Booster Spirit Eu2 02-03 • Cw Booster Spirit [I] 99-00 • Cw Booster Spirit 96-98 • Cw Booster 90-91 • Cw Booster 01-02 • Cw L Booster Spirit 03 • Cw L Booster 01-03 • Cw R Booster Road (Ita) 94-95 • Cw Rs Booster Ng Eu1 99-00 • Cw Rs Booster Ng [I] 95-99 • Cw Rs Booster Ng 01-03 • Cw Rsp Booster Rocket [I] 97-98 • Cw Rxs Booster Track [I] 96-98 • Ew Stunt 00-02 • Ya R Forte (Che-Ita) 94-96 • Ye Evolis [I] 92-95 • Yh Flipper Catalitico 99-00 • Yh Flipper Eu2 03-04 • Yh Flipper 98 • Yh Flipper 01-02 • Ym Fizz [I] 94-95 • Yn R Ovetto (Che-Ita) 97-01 • Yn R Ovetto Eu1 02-04 • Yn R Ovetto Eu2 02-03 • Yq L Nitro Jaguar 04 • Yq Nitro Eu2 03 • Yq Nitro [I] 99-00 • Yq Nitro 04 • Yq Nitro 01-02 (R.O. 3KJ823101000)



24 601 0092



250: Yp Skyliner Abs 03

250: Yp Skyliner Abs 03 • Yp Skyliner 00-03

(R.O. 4HC823100000)

Di primo Equipaggiamento – *OEM Quality*

PEUGEOT

24 601 0132



300: Geopolis

400: Satelis • Geopolis

Di primo Equipaggiamento – *OEM Quality*

24 601 0142



50: Elyseo 04 • Looxor Carb. 04 • Ludix 10 One 04

• Ludix 10 Sp Blaster 04 • Ludix 10 Trend • Snake

04 • Ludix 14 Classic 04 • Ludix 14 Elegant 04 •

Metal-X 97-> • Squab 97-> • Trekker 04 • Trk2 Wrc

97-> • X-Fight 04 • Zenith L 97->

100: Elyseo • Looxor Carb. • Speedfight • Trekker

(R.O. 738724)

Di primo Equipaggiamento – *OEM Quality*Lunghezza cavo 30 cm - *Cable lenght 30 cm*



CENTRALINE - BOBINE
COILS

PIAGGIO

24 601 0010

50: Sfera Rst 95-97 • Zip 92-96
125: Hexagon 94-97 • Hexagon Lx-Lxt 98-99 • Hexagon Lx4 98-99 • Liberty 98-00 • Sfera 95-97 • Skipper 94-97 • Skipper Lx 98-99 • Vespa Et4 96-98
150: Hexagon 94-97 • Skipper 94-97 • Skipper Lx 98-99
180: Hexagon Lx-Lxt 98-99
(R.O. 826115)



24 601 0051

50: Ape Eu2 03-10 • Ape FL • FL2 89-95 • Ape FL3 Eupa 96-99 • Ape Rst Mix 99-05 • Ape Tm P 85-89 • Vespa 67-82 • Vespa FL 90 • Vespa FL2 Autom 90-91 • Vespa FL2 Hp 91-97 • Vespa N 89-90 • Vespa Pk 82-84 • Vespa Pk S Automatica 84-89 • Vespa Pk XL Plurimatic 85-90 • Vespa Pk XL Rush 88-89 • Vespa Pk XL 85-88
125: Cosa 2 91-97 • Cosa CL-CLX 88-91 • Vespa FL 89-90 • Vespa Px 98-01 • Vespa Px 30 Anni 07-08 • Vespa Px Eu2 01-07 • Vespa Px T5 85-89 • Vespa Pxe Arcobaleno 81-97 • Vespa Pk 82-84 • Vespa 67-82 • Vespa Pk S Autom 84-89
150: Cosa CL-CLX 88-91 • Cosa 2 91-97 • Vespa Px 98-01 • Vespa Pxe Arcobaleno 81-87
200: Cosa 2 91-97 • Cosa CL-CLX 88-91 • Vespa Px 98-01 • Vespa Pxe Arcobaleno 81-97
(R.O. 2441285)



24 601 0062

24 601 0060

50: Ciao Eu1 99-01 • Ciao Eu2 02-04 • Ciao Mix Teen 96-01 • Ciao Tre 71-99 • Si FL2 91-97 • Si Mix 96-99 • Si 79-88 • Vespa Pk XL Rush 88-89 • Vespa Pk XL 85-88
(R.O. 2441275)



24 601 0072

24 601 0070

50: Free FL 95-02 • Nrg Mc3 01-04 • Nrg Rst Mc2 96-98 • Sfera Maquillage 2 94 • Sfera Rst 95-97 • Vespa Et2 97-05 • Zip Rst 96-99 • Zip Sp 96-00 • Liberty Ptt Eu2 04-05
(R.O. 638678)



24 601 0082

125: Beverly 01-03 • Beverly Eu3 Mic 07 • Beverly Eu3 Sport 07-08 • Beverly Rst 04-07 • Beverly Tourer Eu3 08-09 • Carnaby 07-09 • Hexagon Gtx 00 • Liberty 01-02 • Liberty 4T Eu3 07-08 • Liberty 4T Sport Eu3 06-08 • Liberty Rst Ptt 05-06 • Liberty Rst 04-05 • Liberty Sport 06 • Super Hexagon Gtx 12 01-02 • Vespa Et4 99-02 • Vespa Granturismo 03-05 • Vespa Granturismo Eu3 06-07 • Vespa Gts Eu3 07-09 • Vespa Gtv 4T Navy Eu3 08 • Vespa Gtv 07-08 • Beverly Eu3 07-08 • Liberty 4T Eu3 Delivery 08 • Liberty 4T 06-07
150: Liberty 01-02 • Vespa Et4 99-02 • Liberty 4T Eu3 08 • Liberty 4T Sport Eu3 08 • Liberty Moc 4T 09
180: Hexagon Gtx 00 • S. Hexagon Gtx 12 01-02
200: Beverly 01-03 • Carnaby 07-08 • Liberty 4T Eu3 07-08 • Liberty 4T Sport Eu3 06-07 • Liberty Rst 04 • Liberty Sport 06 • Vespa Granturismo 06-07 • Liberty 06
250: Beverly Rst 04-05 • Beverly 06-07
(R.O. 829337)
Lunghezza cavo 40 cm - Cable length 40 cm



24 601 0102

50: Fly 2T 10 • Liberty Moc 2T & Elle 09-11 • Liberty 2T 06-08 • Liberty 2T Sport 07-08 • Nrg Mc3 01-04 • Nrg Power Dd 06-10 • Nrg Power Dd Serie Spec 07-10 • Nrg Power Dt 06-08 • Nrg Power Dt Serie Spec 07-08 • Typhoon 05-09 • Typhoon 2T Eu2 10-11 • Vespa Lx 2T 05-08 • Vespa Lx 2T FL 09-10 • Vespa Lxv 2T 06-08 • Vespa Lxv 2T Navy 08 • Vespa S 2T & College 07-11 • Zip 00-04 • Zip Sp Eu2 06-09 • Zip 2T 08-10 • Diesis 01 • Fly 2T 05-07 • Liberty 2T Rst 04 • Nrg Power Dd 05 • Typhoon 01-04 • Zip Sp 01-04
(R.O. 58095R)
Di primo Equipaggiamento - OEM Quality





PIAGGIO

24 601 0132

50: Fly 4T 4V 12 • Vespa Lx 4T 4V Touring 10-13 • Vespa Lx 4T 4V 09-13 • Vespa S 4T 4V & College 08-12
125: Beverly Rst 4T 4V ie Eu3 10-13 • Liberty 4T 2V ie Ptt-Ita 12 • Liberty 4T 3V ie E3 13 • Vespa Gts 4T ie Super 09-13 • Vespa Lx 4T Eu3 Touring 10-11 • Vespa Lx Eu3 ie 09-10 • Vespa Lxv ie 4T 10-12 • Vespa S 4T ie & College 09-11 • X7 Evo ie Eu3 09-10
150: Vespa Lx Eu3 ie 09-11 • Vespa Lx touring 10-12 • Vespa S 4T ie & College 09-12
250: Beverly Cruiser 07-09 • Beverly Eu3 Mic 07 • Beverly ie Eu3 06-08 • Beverly Sport 06-08 • Beverly Tourer Eu3 08-09 • Carnaby 08 • Mp3 Lt 09 • Mp3 Mic 08-09 • Mp3 06-08 • Vespa Gt 60 Eu3 06-07 • Vespa Gts Abs 05-12 • Vespa Gts 05-13 • Vespa Gtv 4T Navy Eu3 08 • Vespa Gtv 06-09 • XEvo 07-13 • X7 Eu3 08 • X8 Eu3 05-08
300: Beverly Rst 4T 4V ie Eu3 10-13 • Beverly Tourer Eu3 09-10 • Carnaby Cruiser 09-12 • Vespa Gts ie Touring 11-12 • Vespa Gts ie 12-13 • Vespa Gts Super Sport 12-13 • Vespa Gts Super 08-13 • Vespa Gtv 4T 4V ie 10-13 • Vespa Gtv Via Montenapoleone 10 • X7 Evo ie Eu3 09-10
400: Beverly Eu3 06-07 • Beverly Tourer Eu3 08-10 • Mp3 ie Lt - Sport 08-10 • Mp3 ie Lt Touring 11 • Mp3 Mic 08-11 • Mp3 RL Touring 11 • Mp3 07-08 • X Evo 07-11 • X8 Eu3 06-08
500: Beverly Eu3 06-08 • Beverly 02-06 • X9 Evolution Abs 06-07 • X9 Evolution 03-07 • X9 01-02
 Di primo Equipaggiamento – *OEM Quality*

**24 601 0201**

220: Ape Car P2-P3 78-85 • Ape Mp P501-P601 78-96 • Ape Tm P602 82-83 • Ape Tm P703 FL2 84-05 • Ape Tm 09-12
 (R.O. 2441295)

**24 601 0211**

125: Skipper 94-97 • Skipper Lx 98-99
 (R.O. 2920345)

**24 601 0192**

125: Hexagon Lx4 98-99 • Liberty 98-00 • Sfera 95-97 • Vespa Et4 96-98
 (R.O. 294150)

**24 601 0582**

50: Ape FL - FL2 89-95 • Ape FL3 Europa 96-99 • Ape Rst Mix 99-03 • Ape Tm P 85-89 • Ape 09-16 • Vespa 50-125 67-82 • Vespa FL 90 • Vespa FL2 Automatica 90-91 • Vespa FL2 Hp 91-97 • Vespa N 89-90 • Vespa Pk Automatica 84-89 • Vespa Pk XL Plurimatic 85-90 • Vespa Pk XL Rush 88-89 • Vespa Pk XL 85-88 • Vespa Pk 82-84 • **125:** Cosa 2 91-97 • Cosa CL-CLX 88-91 • Vespa FL 89-90 • Vespa Px Eu2 01-07 • Vespa Px T5 85-89 • Vespa Px 98-01 • Vespa Pxe Arcobaleno 81-97
 (R.O. 2441285)

**24 601 0482**

50: Ape 09-15
 (R.O. 642219)

**24 601 0472**

125-150: Vespa Px
 (R.O. 642443)

**24 601 0490** **24 601 0491** 

50: Fly 4T 25-30 Km/h 08-11 • Fly 4T 2V 13-15 • Fly 4T 05-07 • Liberty 4T Delivery Single 10-14 • Liberty 4T Delivery Tnt 09 • Liberty 4T Ptt (Deu) 07-12 • Liberty 4T Ptt - Double - Nexive 09-15 • Liberty 4T Sport 06-08 • Liberty 4T 05-08 • Liberty Moc 4T & Elle 09-13 • Vespa Lx 4T 05-08 • Liberty 4T Rst 04 • Liberty 4T 00-02 • Vespa Et4 00-05 • Zip 4T 00-05
 (R.O. 639978)

**24 601 0501** 

100: Free 02-03 • Zip 4T 06-10
 (R.O. 969896)





CENTRALINE - BOBINE

COILS

YAMAHA

24 601 0040



50: Bw'S Bump 97-98 • Bw'S Naked 03 • Bw'S Next Gen Cat. 99-00 • Bw'S Next Gen 97-06 • Bw'S Original Eu2 03 • Bw'S Original 97-02 • Cw Sp Bw'S Original Eu2 02 • Cw L Bw'S 03 • Cw Rs Spy 95-98 • Dtr-Dtx 08 • Ew Slider 00-02 • Pw 04-08 • Ya R Axis 95-96 • Yh Why Eu1 99-00 • Yh Why Eu2 03-05 • Yh Why 98-02 • Ym Breeze 94-95 • Yn Neo'S Eu2 02-03 • Yn Neo'S 04-06 • Yn R Neo'S 97-01 • Yq Aerox R 99-00 • Yq Aerox 97-10 • Yq L Aerox Eu2 03

80: Yz Lc-Lw 97 • Yz N-Lw 01

100: Yn Neo'S 99-02 • Yq Aerox 00-02

125: Dt R 99-00 • Sr 99-00 • Tw 99-03 • Xn Teo'S 00 • Yp Majesty 98-00

150: Yp Majesty 01-02

(R.O. 3KJ823101000)

24 601 0092



250: Yp Majesty Abs 03 • Yp Majesty Dx 98-99 • Yp Majesty 96-03

Di primo Equipaggiamento – *OEM Quality*



SYM

24 601 0162



125: Hd Eu 2 03-04 • Hd Eu 3 07-08 • Hd Evo Eu 3 07-10 • Hd Evo Tamburo Eu 3 08-09 • Hd Evo 05-06 • Joyride Eu 2 03-04 • Joyride 01-02

200: Hd Eu 2 03-04 • Hd Evo Eu 2 05 • Joyride Eu 2 03-04 • Joyride 03

(R.O. 3051AH9A000)

Di primo Equipaggiamento – *OEM Quality*

24 601 0112



50: Tr S Street Magic

110: Ug Hokuto

125: An S-Y • Uc Epicuro X-K1 99-01 • Ue Ct K1

150: Uc Epicuro X-K1 99-01 • Ue Ct K1

Di primo Equipaggiamento – *OEM Quality*



APRILIA

24 601 0402

APRILIA 750: Shiver • Dorsoduro 07-14
(R.O. 640695)



BENELLI

24 601 0292

BENELLI: 899 • 1130
(R.O. 500033012000-R500033012000)



BMW

24 601 0222

BMW 200: C1
650: F 650 Gs
(R.O. 12132346570)



24 601 0262

BMW: R45-R60-R65-R75-R80-R100 77-80



24 601 0272

BMW: R 850 • R 1100 • R1150 • R 1200 C
(R.O. 12131341978-12132306330)



24 601 0312

BMW: R900 • R1200 • HP2
Doppia accensione - sinistra
Twin spark - left
(R.O. 7698929-7715857-8520173)



24 601 0322

BMW: R900 • R1200 • Hp2
Doppia accensione - destra
Twin spark - right
(R.O. 7676572-7692262-7696515-7715856-8520174)



24 601 0332

BMW: R900 • R1150 (Da - from 02-12)
R1200 • Hp2
Doppia accensione destra - sinistra
Twin spark left - right
(R.O. 7671896-7680644-7715853-8620154)



24 601 0342

BMW: F650 06-12 • F700 11-14 • F800 04-14
K1200 03-07 • K1300 07-14
(R.O. 4645117-7670815-7709080-7715846)



DUCATI

24 601 0232

DUCATI: 749 S • 999 • 999 R
(R.O. 38040081A-38040082A)



24 601 0242

DUCATI: 1000 • 1100 • 1200
(R.O. 38040101C)



24 601 0252

DUCATI: 749 • 999 • 1098 • 1200
(R.O. 38010143A-38010143B-38010145B)



DUCATI

24 601 0282

DUCATI: 748 • 851 • 888 • 916 • 996 • 998
(R.O. 28540031A)



24 601 0352

DUCATI: 899 • 1199 Panigale
(R.O. 38040221B)



24 601 0372

DUCATI: 848 • 1198
(R.O. 38010144B)



KTM

24 601 0392

DUCATI: 620 • 695 • 696 • 795 • 796 • 800 • 1100
(R.O. 38010151A)



24 601 0382

KTM: 990 Superduke R 08-13
(R.O. 61139006000)



MV AGUSTA

24 601 0302

MV AGUSTA: 910 • 989 • 990 • 1000 • 1078 • 1090
(R.O. 8000A6700)



PIAGGIO

24 601 0362

PIAGGIO 125-250-300-400: Mp3 Ie • Mp3 Ibrido
(R.O. 641007)



24 601 0412

BOBINA - COIL
50: Fly 4T 4V 12 • Vespa Lx 4T 4V Touring 10-13
Vespa Lx 4T 4V 09-13 • Vespa S 4T 4V & College
08-12
125: Beverly Rst 4T 4V Ie Eu3 10-13 • Liberty
4T 2V Ie Ptt-Ita 12 • Liberty 4T 3V Ie E3 13 •
Vespa Gts 4T Ie Super 09-13 • Vespa Lx 4T Eu3
Touring 10-11 • Vespa Lx Eu3 Ie 09-10 • Vespa
Lxv Ie 4T 10-12 • Vespa S 4T Ie & College 09-11
X7 Evo Ie Eu3 09-10
150: Vespa Lx Eu3 Ie 09-11 • Vespa Lx touring
10-12 • Vespa S 4T Ie & College 09-12
250: Beverly Cruiser 07-09 • Beverly Eu3 Mic
07 • Beverly Ie Eu3 06-08 • Beverly Sport 06-08
• Beverly Tourer Eu3 08-09 • Carnaby 08 • Mp3
Lt 09 • Mp3 Mic 08-09 • Mp3 06-08 • Vespa Gt
60 Eu3 06-07 • Vespa Gts Abs 05-12 • Vespa Gts
05-13 • Vespa Gtv 4T Navy Eu3 08 • Vespa Gtv
06-09 • XEvo 07-13 • X7 Eu3 08 • X8 Eu3 05-08

300: Beverly Rst 4T 4V Ie Eu3 10-13 • Beverly
Tourer Eu3 09-10 • Carnaby Cruiser 09-12 • Ve-
spa Gts Ie Touring 11-12 • Vespa Gts Ie 12-13 •
Vespa Gts Super Sport 12-13 • Vespa Gts Super
08-13 • Vespa Gtv 4T 4V Ie 10-13 • Vespa Gtv
Via Montenapoleone 10 • X7 Evo Ie Eu3 09-10
400: Beverly Eu3 06-07 • Beverly Tourer Eu3
08-10 • Mp3 Ie Lt - Sport 08-10 • Mp3 Ie Lt Tour-
ing 11 • Mp3 Mic 08-11 • Mp3 RL Touring 11 •
Mp3 07-08 • X Evo 07-11 • X8 Eu3 06-08
500: Beverly Eu3 06-08 • Beverly 02-06 • X9
Evolution Abs 06-07
• X9 Evolution 03-07
• X9 01-02 •
Di primo
Equipaggiamento
OEM Quality





CC	MODELLO MODEL	ANNI YEARS	CODICE RMS RMS CODE	NOTE NOTES	CC	MODELLO MODEL	ANNI YEARS	CODICE RMS RMS CODE	NOTE NOTES
APRILIA					1100	R 1100 S (From 12/02 , Twin S)	02-05	24 601 0332	
750	SL 750 Shiver	07-14	24 601 0402		1150	R 1150 Gs (Single Spark Plug)	98-03	24 601 0272	
750	Smv 750 Dorsoduro	08-14	24 601 0402		1150	R 1150 R (Single Spark Plug)	99-06	24 601 0272	
750	SL 750 Shiver Gt	09	24 601 0402		1150	R 1150 Rs (Single Spark Plug)	00-04	24 601 0272	
750	Smv 750 Dorsoduro Factory	10-13	24 601 0402		1150	R 1150 Rt (Single Spark Plug)	00-06	24 601 0272	
BENELLI					1150	R 1150 Gs Adv (Single Spark P)	01-05	24 601 0272	
899	Tnt 899	08-14	24 601 0292		1150	R 1150 R (From 12/02 , Twin S)	01-02	24 601 0272	
899	Tre 899 K	09	24 601 0292		1150	R 1150 Gs (From 12/02, Twin S)	02-03	24 601 0332	
899	Cafe' Racer 899	10	24 601 0292		1150	R 1150 Gs Adv (From 12/02, T.S.)	02-05	24 601 0332	
900	Tnt 899 S	08-09	24 601 0292		1150	R 1150 R (From 12/02 , Twin S)	02-06	24 601 0332	
900	Century Racer 899	11-14	24 601 0292		1150	R 1150 R Rockster (Twin Spark)	02-05	24 601 0332	
1130	Tnt R 160	10-14	24 601 0292		1150	R 1150 Rs (From 12/02, Twin S)	02-05	24 601 0332	
BMW					1150	R 1150 Rt (From 12/02, Twin S)	02-06	24 601 0332	
200	C1 200 Scooter	99-03	24 601 0222		1200	R 1200 C	96-03	24 601 0272	
475	R 45	78-80	24 601 0262		1200	R 1200 C Independent	00-03	24 601 0272	
475	R 45/N	78-80	24 601 0262		1200	R 1200 Gs	02-09	24 601 0312	Sx-Lh
600	R 60/7	78-80	24 601 0262		1200	R 1200 Rt	03-14	24 601 0312	Sx-Lh
650	F 650 Gs	99-03	24 601 0222		1200	R 1200 St	03-07	24 601 0312	Sx-Lh
650	F 650 Gs Dakar	99-03	24 601 0222		1200	Hp 2 Enduro	04-06	24 601 0312	Sx-Lh
650	R 65	78-80	24 601 0262		1200	R 1200 Gs Adv	05-09	24 601 0312	Sx-Lh
650	F 650 Gs	06-12	24 601 0342		1200	R 1200 R	05-14	24 601 0312	Sx-Lh
700	F 700 Gs	11-14	24 601 0342		1200	Hp 2 Megamoto	06-08	24 601 0312	Sx-Lh
750	R 75/7	76-79	24 601 0262		1200	R 1200 S	06-08	24 601 0312	Sx-Lh
800	R 80/7 N	77-80	24 601 0262		1200	R 1200 Gs	02-09	24 601 0322	Dx-Rh
800	R 80/7 S	77-80	24 601 0262		1200	R 1200 Rt	03-14	24 601 0322	Dx-Rh
800	F800 S	04-10	24 601 0342		1200	R 1200 St	03-07	24 601 0322	Dx-Rh
800	F800 St	04-12	24 601 0342		1200	Hp 2 Enduro	04-06	24 601 0322	Dx-Rh
800	F800 R	05-14	24 601 0342		1200	R 1200 Gs Adv	05-09	24 601 0322	Dx-Rh
800	F800 Gs	06-14	24 601 0342		1200	R 1200 R	05-14	24 601 0322	Dx-Rh
800	F800 Gt	11-14	24 601 0342		1200	Hp 2 Megamoto	06-08	24 601 0322	Dx-Rh
800	F800 Gs Adv	12-14	24 601 0342		1200	R 1200 S	06-08	24 601 0322	Dx-Rh
850	R 850 R	94-97	24 601 0272		1200	R 1200 Gs	02-09	24 601 0332	Dx-Sx/ Rh-Lh
850	R 850 Gs	96-00	24 601 0272		1200	R 1200 Rt	03-14	24 601 0332	Dx-Sx/ Rh-Lh
850	R 850 Rt	96-01	24 601 0272		1200	R 1200 St	03-07	24 601 0332	Dx-Sx/ Rh-Lh
850	R 850 C	97-00	24 601 0272		1200	Hp 2 Enduro	04-06	24 601 0332	Dx-Sx/ Rh-Lh
850	R 850 R	99-07	24 601 0272		1200	R 1200 Gs Adv	05-09	24 601 0332	Dx-Sx/ Rh-Lh
850	R 850 Rt	00-06	24 601 0272		1200	R 1200 R	05-14	24 601 0332	Dx-Sx/ Rh-Lh
900	R 900 Rt (05Sf, 10Sf)	05-13	24 601 0312	Sx-Lh	1200	Hp 2 Megamoto	06-08	24 601 0332	Dx-Sx/ Rh-Lh
900	R 900 Rt (05Sf, 10Sf)	05-13	24 601 0322	Dx-Rh	1200	R 1200 S	06-08	24 601 0332	Dx-Sx/ Rh-Lh
900	R 900 Rt (05Sf, 10Sf)	05-13	24 601 0332	Dx-Sx/ Rh-Lh	1200	R 1200 Gs	02-09	24 601 0332	Dx-Sx/ Rh-Lh
980	R 100 Rs	76-80	24 601 0262		1200	R 1200 Rt	03-14	24 601 0332	Dx-Sx/ Rh-Lh
980	R 100 S	76-80	24 601 0262		1200	R 1200 St	03-07	24 601 0332	Dx-Sx/ Rh-Lh
980	R 100/7	76-80	24 601 0262		1200	Hp 2 Enduro	04-06	24 601 0332	Dx-Sx/ Rh-Lh
980	R 100 Rt	78-80	24 601 0262		1200	R 1200 Gs Adv	05-09	24 601 0332	Dx-Sx/ Rh-Lh
980	R 100 T	78-80	24 601 0262		1200	R 1200 R	05-14	24 601 0332	Dx-Sx/ Rh-Lh
1100	R 1100 Rs	92-01	24 601 0272		1200	Hp 2 Megamoto	06-08	24 601 0332	Dx-Sx/ Rh-Lh
1100	R 1100 Gs	93-99	24 601 0272		1200	R 1200 S	06-08	24 601 0332	Dx-Sx/ Rh-Lh
1100	R 1100 R	93-01	24 601 0272		1200	K 1200 S	03-08	24 601 0342	
1100	R 1100 Gs	94-06	24 601 0272		1200	K 1200 Gt	04-08	24 601 0342	
1100	R 1100 Rt	94-01	24 601 0272		1200	K 1200 R	04-08	24 601 0342	
1100	R 1100 S (Single Spark Plug)	96-05	24 601 0272		1200	K 1200 R Sport	05-07	24 601 0342	
					1300	K 1300 Gt	07-10	24 601 0342	
					1300	K 1300 R	07-14	24 601 0342	
					1300	K 1300 S	07-14	24 601 0342	



BOBINE ACCENSIONE BERU

BERU IGNITION COILS

CC	MODELLO MODEL	ANNI YEARS	CODICE RMS RMS CODE	NOTE NOTES	CC	MODELLO MODEL	ANNI YEARS	CODICE RMS RMS CODE	NOTE NOTES
DUCATI					916	Superbike 916 Sp	94-96	24 601 0282	
620	Multistrada 620	06	24 601 0392		916	Superbike 916 R	97-98	24 601 0282	
620	Multistrada 620 Dark	06	24 601 0392		944	Sport Touring St2	97-03	24 601 0282	
695	Monster 695	07-08	24 601 0392		996	Superbike 916 Sps	97-98	24 601 0282	
696	Monster 696	08-13	24 601 0392		996	Superbike 996 R	99-01	24 601 0282	
696	Monster 696 Abs Anniversary	13	24 601 0392		996	Superbike 996 Sps	99-00	24 601 0282	
696	Monster 696 Anniversary	13	24 601 0392		996	Superbike 996 Sps Li	99	24 601 0282	
748	Superbike 749 S	03-06	24 601 0232		996	Superbike 996 Rs	00-01	24 601 0282	
748	Superbike 749	03	24 601 0252		996	Superbike 996 Sps Lii	00	24 601 0282	
748	Superbike 749 S	03-06	24 601 0252		996	Sport Touring St4 S	01-05	24 601 0282	
748	Superbike 749 Dark	04-06	24 601 0252		996	Superbike 996 R Li	01	24 601 0282	
748	Superbike 749 R	04-06	24 601 0252		996	Superbike 996 S	01	24 601 0282	
748	Superbike 748 R Single-Seat	98	24 601 0282		996	Sport Touring St4 S Abs	03-05	24 601 0282	
748	Superbike 748 Sps	98-99	24 601 0282		998	Superbike 999	03-06	24 601 0232	
748	Superbike 748 R	99	24 601 0282		998	Superbike 999 R	03-06	24 601 0232	
748	Superbike 748 Rs	00-01	24 601 0282		998	Superbike 999	03-06	24 601 0252	
748	Superbike 748 S	00-02	24 601 0282		998	Superbike 999 R	03-06	24 601 0252	
748	Superbike 748 E	01-02	24 601 0282		998	Superbike 999 S	03-06	24 601 0252	
748	Superbike 748 R Single-Seat	01-02	24 601 0282		998	Superbike 999 R Xerox	06	24 601 0252	
750	Supersport 750 Ss	99-02	24 601 0282		998	Superbike 999 S Ama Replica	07	24 601 0252	
750	Supersport 750 S	01-02	24 601 0282		998	Superbike 998	02-03	24 601 0282	
795	Monster 795	12-14	24 601 0392		998	Superbike 998 R	02	24 601 0282	
795	Monster 795 Abs	13-14	24 601 0392		998	Superbike 998 Rs	02-03	24 601 0282	
796	Monster 796	11-12	24 601 0392		998	Superbike 998 S Bayliss	02	24 601 0282	
796	Monster 796 Abs	11-14	24 601 0392		998	Superbike 998 S Bostrom	02	24 601 0282	
796	Monster 796 Abs Anniversary	13	24 601 0392		998	Superbike 998 Final Ed.	04	24 601 0282	
796	Monster 796 Anniversary	13	24 601 0392		998	Superbike 998 Matrix	04	24 601 0282	
796	Monster 796 - Dmt	14	24 601 0392		998	Superbike 998 Matrix Single-Seat	04	24 601 0282	
796	Monster 796 Abs - Dmt	14	24 601 0392		998	Superbike 999 Rs	04-05	24 601 0282	
800	Monster S2 R 800	05-07	24 601 0392		1000	Multistrada 1000	03	24 601 0242	
800	Monster S2 R 800 Dark	05-06	24 601 0392		1000	Sport Touring St3	04-07	24 601 0242	
800	Hypermotard 796	10-12	24 601 0392		1000	Monster S2r 1000	06-08	24 601 0242	
821	Hypermotard Hyperstrada	13-14	24 601 0252		1000	Sport Touring St3 S Abs	06-07	24 601 0242	
821	Hypermotard Sp	13-14	24 601 0252		1000	Sportclassic Paul Smart	06	24 601 0242	
821	Hypermotard Sp 821	13-14	24 601 0252		1000	Sportclassic Sport 1000	06-07	24 601 0242	
848	Streetfighter 848	13-14	24 601 0372		1000	Sportclassic Gt1000	07-10	24 601 0242	
848	Superbike 848 Evo	13	24 601 0372		1000	Sportclassic Sport 1000	07-08	24 601 0242	
848	Superbike 848 Evo Corse Se	13	24 601 0372		1000	Sportclassic Sport 1000 S	07-09	24 601 0242	
850	Superbike 848	08-10	24 601 0372		1000	Hypermotard 1100	08-09	24 601 0242	
850	Superbike 848 Hayden	10	24 601 0372		1000	Hypermotard 1100 S	08-09	24 601 0242	
850	Superbike 848 Evo	11-12	24 601 0372		1000	Sportclassic Gt1000 Touring	09	24 601 0242	
850	Streetfighter 848	12	24 601 0372		1000	Monster S4 Rs	06-08	24 601 0252	
850	Superbike 848 Evo Corse Se	12	24 601 0372		1000	Monster S4 R	07-08	24 601 0252	
851	Superbike 851	91-92	24 601 0282		1000	Monster S4 Rs Tricolore	08	24 601 0252	
888	Superbike 888 Sp5	93	24 601 0282		1098	Streetfighter S	13	24 601 0252	
888	Superbike 888	94-95	24 601 0282		1100	Multistrada 1100	07-09	24 601 0242	
899	Superbike 899 Panigale Abs	14	24 601 0352		1100	Multistrada 1100 S	07-09	24 601 0242	
900	Superbike 907 I.e.	90-93	24 601 0282		1100	Monster 1100	09-10	24 601 0242	
900	Supersport 900 Ss	98-02	24 601 0282		1100	Monster 1100 S	09-10	24 601 0242	
900	Supersport 900 S	02	24 601 0282		1100	Monster 1100 Abs	10	24 601 0242	
916	Superbike 916	94-97	24 601 0282		1100	Monster 1100 S Abs	10	24 601 0242	
916	Superbike 916 Senna	94-98	24 601 0282		1100	Superbike 1098	07-08	24 601 0252	



CC	MODELLO MODEL	ANNI YEARS	CODICE RMS RMS CODE	NOTE NOTES	CC	MODELLO MODEL	ANNI YEARS	CODICE RMS RMS CODE	NOTE NOTES
1100	Superbike 1098 S	07-08	24 601 0252		MV AGUSTA				
1100	Superbike 1098 S Tricolore	07-08	24 601 0252		910	Brutale 910	05-08	24 601 0302	
1100	Streetfighter	10-11	24 601 0252		920	Brutale 920	10-11	24 601 0302	
1100	Streetfighter S	10-12	24 601 0252		989	Brutale 989 R	08-	24 601 0302	
1100	Hypermotard 1100 Evo	10-12	24 601 0392		990	Brutale 990 R	10-11	24 601 0302	
1100	Hypermotard 1100 Evo Sp	10-12	24 601 0392		1000	F4 R	06-07	24 601 0302	
1100	Monster 1100 Evo Abs	12-13	24 601 0392		1000	F4 1000 312 R	07-08	24 601 0302	
1100	Monster 1100 Diesel Eur	13	24 601 0392		1000	F4 Veltro	08	24 601 0302	
1100	Monster 1100 Evo Anniversary	13	24 601 0392		1000	F4 S - R - Rr - Freccce Tricolore	10-12	24 601 0302	
1198	Superbike 1199 Panigale Abs Br	14	24 601 0352		1078	F4 1000 Cc	07	24 601 0302	
1198	Superbike 1199 Panigale S Abs	14	24 601 0352		1078	F4 1078 312 Rr	07-08	24 601 0302	
1199	Superbike 1199 Panigale R	13	24 601 0352		1078	Brutale 1078 Rr	08	24 601 0302	
1199	Superbike 1199 Panigale Super L	14	24 601 0352		1090	Brutale 1090 Rr	10-11	24 601 0302	
1200	Multistrada 1200 Abs	13-14	24 601 0242		1090	Brutale R - Rr	12-13	24 601 0302	
1200	Multistrada 1200 S Gt	13-14	24 601 0242		PIAGGIO				
1200	Multistrada 1200 S Pikes Peak	13-14	24 601 0242		125	Mp3 le	08-09	24 601 0362	
1200	Multistrada 1200 S Touring	13-14	24 601 0242		125	Mp3 Ibrido	09-10	24 601 0362	
1200	Monster 1200	14	24 601 0242		125	Mp3 le Touring	11-12	24 601 0362	
1200	Monster 1200 S	14	24 601 0242		250	Mp3	06-08	24 601 0362	
1200	Multistrada 1200 Abs - Dmb	14	24 601 0242		300	Mp3 300 le Lt	10-11	24 601 0362	
1200	Multistrada 1200 Abs - Dmt	14	24 601 0242		300	Mp3 300 le Mic	10-11	24 601 0362	
1200	Multistrada 1200 S Touring	14	24 601 0242		300	Mp3 4T 4V le Erl Ibrido	10-13	24 601 0362	
1200	Diavel Carbon FL	15	24 601 0242		300	Mp3 4T 4V le Lt Ibrido	10-11	24 601 0362	
1200	Diavel FL	15	24 601 0242		300	Mp3 le Lt-le Lt Sport	11-13	24 601 0362	
1200	Superbike 1098 R	08-10	24 601 0252		300	Mp3 Touring 300 le	11-12	24 601 0362	
1200	Superbike 1098 R Bayliss	09	24 601 0252		300	Mp3 Touring Lt 300 le	11-12	24 601 0362	
1200	Multistrada 1200	10-12	24 601 0252		400	Mp3	07-08	24 601 0362	
1200	Multistrada 1200 Abs	10-12	24 601 0252						
1200	Multistrada 1200 S Abs	10	24 601 0252						
1200	Multistrada 1200 S Touring	10-12	24 601 0252						
1200	Diavel	11-13	24 601 0252						
1200	Diavel Carbon	11-13	24 601 0252						
1200	Multistrada 1200 S Sport	11-12	24 601 0252						
1200	Multistrada 1200 S Pikes Peak	12	24 601 0252						
1200	Diavel Amg Europe	13	24 601 0252						
1200	Diavel Cromo Europe	13	24 601 0252						
1200	Diavel Strada	13-14	24 601 0252						
1200	Diavel White Stripe	13-14	24 601 0252						
1200	Superbike 1199 Panigale	12-13	24 601 0352						
1200	Superbike 1199 Panigale Abs	12-14	24 601 0352						
1200	Superbike 1199 Panigale S	12-13	24 601 0352						
1200	Superbike 1199 Panigale S Abs	12-14	24 601 0352						
1200	Superbike 1199 Panigale S Tric	12-13	24 601 0352						
1200	Superbike 1199 Panigale R	14	24 601 0352						
1200	Superbike 1198	09-11	24 601 0372						
1200	Superbike 1198 S	09-10	24 601 0372						
1200	Superbike 1198 S Corse	10	24 601 0372						
1200	Superbike 1198 Sp	11	24 601 0372						
KTM									
990	990 Superduke R	08-13	24 601 0382						
MAICO									
125	125 Gs/6	70-83	24 601 0262						



REGOLATORI
REGULATORS

APRILIA

24 603 0050



24 603 0051



50: Amico 94-98 • Area 51 98-00 • Gulliver 95-98 • Rally 95-03 • Scarabeo 93-05 • Sr 93-96 (R.O. AP8212540)



24 603 0060



50: Mojito Custom 99-03 • Mojito Retro 99-03 • Sr H2O Ditech e Carburatore 00-03 (R.O.AP8224102)



24 603 0152



50: Mojito 04-08 • Scarabeo 2T/Net 10 • Scarabeo Street 2T Restyling 04-09 • Sport Cuty one 2T 08-10 • Sr R Factory ie Carburatore 10-11 • S R R R Factory 04-09 • Sr Street 03-08
125: Mojito Retro Custom 99-01 • Habana Custom (R.O. 58096R-82587R)
Di primo equipaggiamento – *O.E.M. Quality*



24 603 0162



50: Sr ie / R Factory (motore Piaggio Purejet)
125: Atlantic Eu3 10-11 • Mojito 03-08 • Rs4 11 • Sport City Cube 08-10 • Sport City One 4T Eu 3 06-08 • Sport City 04-06 • Scarabeo 03-06 • Scarabeo Eu3 06-07
250: Atlantic Eu3 06-08
450: Mxv 08-10 (R.O. 58090R)
Di primo equipaggiamento – *O.E.M. Quality*



24 603 0182



50: Scarabeo Quattro 09 • Scarabeo 4T • 4V / Net 10 • Sport City One 4T 08-10
100: Scarabeo 4T 01-04 (R.O. 639751-641788)
Di primo equipaggiamento – *O.E.M. Quality*



24 603 0192



125: Atlantic Eu3 06-08 • Sport City Eu3 06-08 Sr Max 11
250: Sport City Cube 08-10 • Scarabeo Light 06-08
300: Scarabeo Light 09-10 • Sport City Street 12 Sr Max 11-13
400: Atlantic Sprint 05-08 • Scarabeo Light 06-08
500: Atlantic 01-04 • Scarabeo 03-06 (R.O. 58086R-639110)
Di primo equipaggiamento – *O.E.M. Quality*



BENELLI

24 603 0011



125-150: Velvet 99-01 • Velvet Touring 02-03 (R.O.R51540101A0)



24 603 0012



125-150: Velvet 99-01 • Velvet Touring 02-03 (R.O.R51540101A0)



24 603 0162



125-150: Adiva
Di primo equipaggiamento – *O.E.M. Quality*





BETA

24 603 0050 

24 603 0051 

50: Ark Air • Lc 96-08 • Ark Lc Serie K 04-08
• Quadra Chrono 502 95-96 • Tempo 94-99
01-02 • Nitro 97-04 • Ovetto 97-01 • Stunt 00-02



DERBI

24 603 0152 

50: Boulevard 09
(R.O. 58096R-82587R)
Di primo equipaggiamento – *O.E.M. Quality*

24 603 0162 

125: Rambla
125-150-200: Boulevard
250: GP1 (Carburatore - *Carburetor*)
(R.O. 58090R)
Di primo equipaggiamento – *O.E.M. Quality*



DERBI

24 603 0182 

50: Atlantis 4T Eu2 07 • Boulevard 4T Eu3 09
(R.O. 639751-641788)
Di primo equipaggiamento – *O.E.M. Quality*

24 603 0192 

125: Rambla 08-09
250: Rambla 08-09
300: Rambla 10-11
(R.O. 58086R)
Di primo equipaggiamento – *O.E.M. Quality*



GILERA

24 603 0040 

24 603 0042 

50: Easy Moving-Storm -94-95
• Typhoon 94-97 • Stalker 97-98
(R.O.185824-291931-294016-2940165)
Di primo equipaggiamento – *O.E.M. Quality*

24 603 0152 

50: Dna 00-07 • Dna Gp Grexperience 03-04 •
Ice 01-05 • Runner Poggiali 02 • Runner Sp 02-
10 • Runner Sp Special Editor 07 • Runner Sp St
Simoncelli 08-09 • Runner 97-00 • Stalker 97-10
• Stalker Naked • Special Edition 07-08 • Storm
Eu2 07 • Typhoon X • Xr 98-00
(R.O. 58096R - R.O. 82587R)
Di primo equipaggiamento – *O.E.M. Quality*

24 603 0162 

50: Runner Purejet • Runner Vx
125: VXR • Nexus (Carburatore - *Carburetor*)
180-200: Dna
(R.O. 58090R)
Di primo equipaggiamento – *O.E.M. Quality*





REGOLATORI
REGULATORS

HONDA

24 603 0060



50: Gp Dio 91> • Sfx V 95 > • Sh 91-96 • Sj Bali 93> • Sxr 95>
100: Sh 96-99 • Sj Bali 96-99
(R.O.31600GBL871)



24 603 0100



125-150: Sh 01-04 • @ 01-06
(R.O. 31600-KFG-860)



24 603 0102



125-150: Sh 01-04 • @ 01-06
(R.O. 31600-KFG-860)



24 603 0212



125: Ns F/R 85-87 • Nsr F 88-92
(R.O. 31600KR1761)
Di primo equipaggiamento – *O.E.M. Quality*



24 603 0241



24 603 0242



125-150: Sh I 05>
(R.O. 31600-KTF-841)



ITALJET

24 603 0011



125-150: Millennium 00
(R.O.4870706560)



24 603 0012



125-150: Millennium 00
(R.O.4870706560)



24 603 0162



125-150: Torpedo (Leader) • Jet Set
Di primo equipaggiamento – *O.E.M. Quality*





ITALJET

24 603 0182 

50: Torpedo 4T
Di primo equipaggiamento – *O.E.M. Quality*



KAWASAKI

24 603 0312 

300: J Abs 14-15
(R.O. 21066Y003)



KYMCO

24 603 0070 

24 603 0072 

50: Agility 4T R10 07-08 • B&w 02 • Dink 98-02
• Dj W-X-Y 91-00 • Filly 98-00 • Heroism 95-97
• People 99-00 • Super 9 00
125-150: Movie XL Eu2 99-04 • People 99-00
• Vivio 00
(R.O.00169004)



24 603 0081 



125-150: B&w 00 • Dink 97-98 • Dink Classic 02
• Grand Dink Eu2 01-04 • Heroism 95-97
200: Dink Classic 04 • People S 01-07
250: B&w 00 • Grand Dink 01-02 • People Lc
03-04 • X Citing 05
(R.O.00168780)

24 603 0082 

Di primo equipaggiamento – *O.E.M. Quality*



24 603 0112 

250: People S 06
(R.O.00168139)
Di primo equipaggiamento – *O.E.M. Quality*



24 603 0122 

50: Agility 2T R16 10 • Rs Naked 2T 10 • Like
2/4T 09 • Super 8 2/4T 07-09
125: Like / Like Ls 09-12 • People S Dd Eu3
07-08 • Super 8 08-09
200: People S 05
(R.O.00169587)
Di primo equipaggiamento – *O.E.M. Quality*



24 603 0132 

50: Agility 4T R16 08-09 • Agility Rs 09
125: Agility R16 08-09 • Agility Rs 09
150: Agility R16 08-09
(R.O.00131033)
Di primo equipaggiamento – *O.E.M. Quality*



24 603 0142 

125: Downtown 125 I 09
200: Dink Eu3 i 06-07
250: People S 250 I 07 • Venox 02-03
• Venox Eu2 04-07 • X Citing I 06-07
300: Downtown 300 I 09 • People S 300 I 08 • X
Citing 300 I 08 • X Citing 300 I R 08-09
500: X Citing 05 • X Citing 500 R 09
• X Citing 500 I 06-08 • X Citing 500 I R 07-08
(R.O.00177005)
Di primo equipaggiamento – *O.E.M. Quality*





REGOLATORI
REGULATORS

KYMCO

24 603 0172 

125: Dink Euro 3 04-07 • Quannon 08
• Quannon Naked 10
200: Agility i 01 • R16 10 • Like 01 09
(R.O. 00168783)
Di primo equipaggiamento – *O.E.M. Quality*



24 603 0212 

125-150: Zing
Di primo equipaggiamento – *O.E.M. Quality*



24 603 0302 

125: K-Xct I 12-14 • **300:** K-Xct I Abs 14 • K-Xct I
12 • **400:** X Citing I Abs 14-15
• X Citing I 13
(R.O. 00131148)



MALAGUTI

24 603 0011 

125: Madison 99-01 • Phantom Max 03
150: Madison T 99-01
(R.O.02601400)



24 603 0012 

125: Madison 99-01 • Phantom Max 03
150: Madison T 99-01
(R.O.02601400)



24 603 0050 

24 603 0051 

50: Centro Base 93-94 • Centro SL Impianto
Ducati 94-98 • Centro SL Impianto Yamaha 94-
98 • Ciak 99-00 • Crosser Cr1 95-98 • F10 Ac 08
• F12 Phantom 94-98 • F15 Firefox 96-98
• Yesterday 97-00
100: Ciak 99-00 • F12 Phantom 99-00
(R.O. 02601100)



24 603 0070 

24 603 0072 

125-150: Ciak 00-01 • Ciak Master 04
• Ciak Rst Eu2 03
(R.O.02601500)



24 603 0082 

125-150: F18 Warrior 00-02
(R.O.02601800)



24 603 0102 

400: Madison K 02-04
(R.O. 02601900)





MALAGUTI

24 603 0100 

400: Madison K 02-04
(R.O. 02601900)



24 603 0122 

125: Ciak Master Eu3 06
200: Ciak Master Eu2 06
(R.O.02603000)



24 603 0162 

180-200-250: Madison
(Carburatore - *Carburetor*)
200-250: F12 Max
(R.O. 02601600)



MBK

24 603 0182 

50: Centro 4T SL 08-10 • Ciak Master 4T 05



24 603 0011 

125-150: Doodo 00-01 • Skyliner 98-00
(R.O: 5DSH196000)



24 603 0050 

24 603 0051 

50: Booster 90-03 • Booster Road 94-95
• Booster Spirit 96-00 • Booster Track 96-98
• Evolis 92-95 • Fizz 94-95 • Flipper 01-02
• Nitro 97-04 • Ovetto 97-01 • Stunt 00-02
(R.O. 4V VH196001)



24 603 0070 

24 603 0072 

50: Booster 04 • Booster Spirit 03 • Flipper Eu2
03-04 • Nitro Eu2 03
100: Ovetto 00-02
(R.O.5RNH19600000)



24 603 0090 

24 603 0092 

125-150: Skyliner 01-03
(R.O.4HMH19600000)





PIAGGIO

24 603 0020 

50: Ape Tm P 85-89 • Vespa FL 90 • Vespa N 89-90
• Vespa Pk XL 85-88 • Vespa Pk XL Rush 88-89
125: Cosa 2 91-97 • Vespa FL 89-90 • Vespa Pk XL
86-89 • Vespa Px 98-01 • Vespa Px Eu2 01-07
(R.O.2308245)



24 603 0030 

24 603 0031 

50: Vespa Pk 82-84 • Vespa Pk S Automatica
84-89 • Vespa Pk XL Plurimatic 85-90
125: Vespa Pxe Arcobaleno 81-97
(R.O.1616395)



24 603 0102 

250: X9 00-01
(R.O. 496454)



24 603 0260 

420: Ape Car - Max Diesel 86-96
(R.O. 231877)



24 603 0270 

220: Ape Car P2-P3 78-85 • Ape Mp P501
- P601 78-96 • Ape Tm P602 • Ape Tm P703-
P703V - FL2 84-05
(R.O. 157714)



24 603 0040 

24 603 0042 

50: Ape FL - FL2 89-95 • Ape FL3 Europa 96-99 •
Free 92-94 • Free FL 95-02 • Nrg 94-96 • Nrg Rst
Mc2 96-98 • Ntt 95-96 • Quartz 92-96 • Sfera 91-93
• Sfera Maquillage 2 94 • Sfera Rst 95-97 • Velofax
96-99 • Vespa Et2 97-05 • Vespa FL2 Automatica
90-91 • Vespa FL2 Hp 91-97 • Vespa Pk 82-84 •
Vespa Pk Automatica 84-89 • Zip 92-96 • Zip Fast
Raider • Zip Sp 96-00
125: Sfera 95-97 • Vespa Et4 96-98 • Vespa Pxe
Arcobaleno 81-97
(R.O. 2940165)

Di primo equipaggiamento - *O.E.M. Quality*

24 603 0162 

50: Nrg Purejet/Power Purejet
125: Zip 4T-Mp3 (Carburatore - *Carburetor*) •
Fly • Skipper ST • X8 • 4T-Super Hexagon Gtx
125-150: Vespa Et4 (motore Leader)-Vespa Lx
125-150-200: Liberty (motore Leader) •
Beverly (Carburatore - *Carburetor*)
125-200: Vespa Gt • Carnaby
250: X9 (mot.Piaggio)
(R.O. 58090R)

Di primo equipaggiamento - *O.E.M. Quality*



24 603 0152 

50: Ape Rst Mix 99-03 • Ape Eu2 03-10
• Diesis 01 • Fly 2T 05-10 • Free Delivery / FL
00-02 • Liberty 97-08 • Liberty 2T Sport 06-08
• Liberty Rst 04 • Liberty Ptt Eu2 04-05
• Liberty Mog 2T 09-10 • Nrg Extreme 99-00
• Mc3 01-04 • Nrg Rst Mc2 98> • Nrg Power
Dd 05-10 • Nrg Power Dd Serie Speciale 07-10
• Nrg Power Dt 06-08 • Nrg Power Dt Serie
Speciale 07-08 • Typhoon 2T Eu2 10-11
• Typhoon 01-09 • Vespa Et2 5-98> • Vespa Lx
2T 05-08 • Lx 2t FL 09-10 • Lx U 2T 06-08 • Ve-
spa Lxv 2T Navy 08 • Vespa S 2T college 07-10 •
Zip 2T 08-10 • Zip 00-04 • Zip Rst 99>
• Zip Sp 01>
125: Hexagon Lx4 98-99 • Liberty 98-10
• Vespa Et4
(R.O. 58096R - R.O. 82587R)

Di primo equipaggiamento - *O.E.M. Quality*



24 603 0182 

50: Fly 4T motore Chn 04-07 • Fly 4T 05-10
• Liberty 4T 00-08 • Moc 4T e Elle 09-10
• Liberty 4T Delivery Tnt 09 • Liberty 4T Rst 04
• Liberty 4t Sport 06-08 • Liberty 4T Ptt 09-10
• Vespa Lx 4T/4V Touring 05-10 • Vespa S 4T/4V
08-09 • Vespa Et4 05 • Zip 4T 00-10
100: Fly 4T 06-08 • Zip 4T 06-10 • Free 02-03
(R.O. 639751-641788)

Di primo equipaggiamento - *O.E.M. Quality*





PIAGGIO

24 603 0192

125: Mp3 Ibrido 09-10 • Mp3 Ie 08-09
250: Beverly Cruiser 07-09 • Beverly Eu 3 Mic 07 • Beverly Ie Eu3 06-08 • Beverly Sport 06-08 • Beverly Tourer Eu3 08-09 • Carnaby 08 • Mp3 Lt 09 • Mp3 Mic 08-09 • Mp3 06-08 • Vespa Gt 60 Eu3 06-07 • Vespa Gts, Gts Abs 05-11 • Vespa Gtv 4T Navy Eu3 08 • Vespa Gtv 06-09 V X Evo 07-11 • X7 Eu3 08 • X8 Eu3 05-08
400: Beverly Eu3 06-07 • Beverly Tourer Eu3 08-10 • Mp3 Ie Lt - Mp3 Ie Lt Sport 08-10 • Mp3 Mic 08-11 • Mp3 07-08 • X Evo 07-11 • X8 Eu 3 06-08
500: Beverly Cruiser 07-12 • Beverly Eu 3 06-08 • Beverly 05 • X9 Evolution Abs, X9 Evolution 06-07 (R.O. 58086R)

Di primo equipaggiamento – *O.E.M. Quality*



24 603 0292

125: Fly 4T Ie E3 Dt 13 • Fly 4T 3V Ie Eu3 Lem 12-13 • Liberty 4T 2V Ie Ptt - Ita 12 • Liberty 4T 3V Ie E3 13-14 • Vespa 946 4T 3V Abs 13-14 • Vespa Lx 4T 3V Ie Touring 12-13 • Vespa Lx 4T Eu3 Touring 10-11 • Vespa Lx Eu3 Ie 09-11 • Vespa Lxv Ie 4T 10-13 • Vespa S 4T 3V Ie 12 • Vespa S 4T Ie & College 09-11
150: Liberty 4T 3V Lem 13-14 • Vespa Gts Super Ie 4T 3V 14 • Vespa Lt 4T 3V Ie 14 • Vespa Lx 4T 3V Ie Touring 12-13 • Vespa Lx Eu3 Ie 09-11 • Vespa Lx Touring 10-12 • Vespa S 4T Ie & College 09-12 (R.O. 58204R)



24 603 0281

125: Mp3 Ie 08-12 • Vespa Gts 4T Ie Super 09-14 • **250:** Vespa Gts 05-14 • **300:** Beverly Rst 4T 4V Ie Eu3 10-14 • Mp3 Ie Mic 10-11 • Mp3 Ie Lt 11-13 • Mp3 4T 4V Ie Lt Ibrido 10-11 • Mp3 Yourban 11-14 • Vespa Gts 11-14 • Vespa Gtv 10-13 (R.O. 641709 Ex 58203R/641533/58208R)



SUZUKI

24 603 0050

24 603 0051

50: Address 92-95 • Sepia S 95-97



SYM

24 603 0212

50: Jet Eu 2 2T 05-10
125: New Duke • Husky
125-150: Euro Mx • Shark (R.O. 3160-N28-000)

Di primo equipaggiamento – *O.E.M. Quality*





REGOLATORI
REGULATORS

YAMAHA

24 603 0050



24 603 0051



50: Aerox 97-02 • Breeze 94-95 • Bw'S Bump 97-98 • Bw'S Next Generation 97-02 • Bw'S Original 97-02 • Neo'S 97-01 • Slider 00-02
100: Aerox 00-02
(R.O.4VVH19600100)



24 603 0070



24 603 0072



50: Aerox 04-09 • Bw'S 03-10 • Bw'S Ng 03-06 • Jog R 06-10 • Neo'S 04-10 • Why 06
100: Neo'S 99-02
(R.O.5RNH19600000)



24 603 0011



125-150: Majesty 98-00 • Maxster 01-02
(R.O.5DSH1960000)



24 603 0012



125-150: Majesty 98-00 • Maxster 01-02
(R.O.5DSH1960000)



24 603 0090



24 603 0092



125: Majesty 01-09 • X Max Abs 11 • Yz Fr 08-11
150: Majesty 01-02
180: Majesty 03-04
250: Rx Max 10-11 • Rx Max Sport 11 • Rx Max Abs 11
(R.O. 4HMH19600000)



24 603 0222



125: X City 08-11 • X Max 06-09
250: X City 07-12 • X Max 07-09
(R.O. 5BN819600000)



24 603 0232



125: X Max 10-12 • Xzf R 08-11
250: Yp Majesty 00-01
500: Yp T Max 01-03
600: Fzr R 94-95 • Yzf R6 99-02
660: Xt Z Tenere 94-96
1000: Yzf R1 98-01
(R.O. 4JH8196001000)





APRILIA

24 639 0010 

50: Mojito 04-08 • Scarabeo 2T Eu2 Mot.Piaggio 10-11 • Scarabeo 2T Net 09-10 • Scarabeo Street 2T Rst 06-09 • Sport City One 2T 08-10 Sr R Factory ie e Carburatore 10-11 • Sr R Factory 04-09 • Scarabeo Street 05-06 • Sr Street 03-11
(R.O. 82530R)



24 639 0020 

50: Amico 94 • Amico GL-GLE 93-95 • Area 51 98-00 • Gulliver 95-98 • Gulliver Lc 96-98 • Rally 95-03 • Rally Liquid Cooled 96-99 • Sr 94-96 • Sr Www 97-01
(R.O. AP8206459)



24 639 0090 

125: Atlantic Eu3 06-11 • Mojito 03-08 • Sport City Cube 08-10 • Sport City Eu3 06-08 • Sport City 04-05 • Scarabeo Eu3 06-07 • Scarabeo 03-06 • Sr Motard 12
200: Atlantic 03-05
(R.O. 82611R)



24 639 0080 

50: Scarabeo 4T Rst Eu3 06-09 • Scarabeo Quattro 09 • Rs 06-10 • Scarabeo 4T 4V Net 09-10 • Sport City One 4T 08-10 • Scarabeo 4T 02-06 • Sr Street 05-11
(R.O. 96921R)



24 639 0100 

125: Mojito Retro' • Custom 99-01
(R.O. AP8550442)



24 639 0110 

100: Scarabeo 4T Net Eu3 10 • Scarabeo 4T Net 10 • Scarabeo 4T Restyling 06-09 • Scarabeo 4T 10-12
125: Sr 99-01
(R.O. AP8551026 • AP8550078)



24 639 0160 

50: Mojito Custom - Retro 99-03 • Scarabeo Ditech 01-04 • SR Ditech Eu2 02-03 • SR H2O Ditech e Carburatore 00-03 • SR R Factory Mot. Aprilia 05
(R.O. AP2QCA000041)



24 639 0190 

250: Leonardo St 01 • Leonardo 99-04
(R.O. AP8122628)



24 639 0210 

125: Leonardo St 03-04 • Leonardo 99-02 • Scarabeo Motore Rotax 99-03
(R.O. AP0295625)





MOTORINI AVVIAMENTO
STARTER MOTORS

APRILIA

24 639 0220



125: Sport City Eu3 06-08 • Sr Max 11
250: Atlantic Eu3 06-08 • Scarabeo Light 06-08
• Sport City Cube 08-10
300: Atlantic 10-11 • Scarabeo Light 09-10
• Sr Max 11
(R.O. 58142R)

24 639 0230



400: Atlantic Sprint 05-08 • Scarabeo Light 06-08
500: Atlantic 01-04 • Scarabeo 03-06
(R.O. 82699R)

24 639 0170



100: Scarabeo 00
(R.O. AP8510653)



BENELLI

24 635 0340



APRILIA 250: Leonardo St 01 • Leonardo 99-01
(R.O.AP8122429)

24 639 0020



50: 491 Gt 98-99 • 491 Racing 98-99 • 491 Rr 98-01 • 491 Sp 99 • 491 Sport 98-99 • 491 St 0 • K2 98-01 • K2 Liquid Cooled 99-01 • Naked 02 • Pepe 99-01 • Pepe Lx 03-04
(R.O. R19240011A0)

24 639 0150



125: Velvet 125-150 99-01 • Velvet Touring 02-03
(R.O. 5DSH18000000)



24 639 0160



50: Naked (Motore Morini dal 2003)
• 491 (Motore Morini dal 2003)

24 639 0190



250: Velvet Touring 02-03 • Velvet 99-01
(R.O. R13040191A0)





DERBI

24 639 0010 

50: Atlantis 02 02 • Atlantis 02 Bullet 03-05 • Atlantis 02 City 03-06 • Atlantis 02 Red Bullet 03 • Atlantis 02 Two Chic 05 • Atlantis 2T Eu2 07-09 • Boulevard 2T 09 • Gp1 01-02 • Gp1 03 • Gp1 Open Eu2 06-09 • Gp1 Race Eu2 05-07 (R.O. 82530R)



24 639 0080 

50: Atlantis 4T 04-06 • Atlantis 4T Eu2 07 • Boulevard 4T Eu2 25 Km/h 09 • Gpr Nude & Gpr Nude Tuning 06-08 • Gpr Nude Sport 06 • Gpr Racing Eu2 06 • Gpr Replica & Gpr R Eu2 06 • Gpr Replica 2T Malossi 07 • Gpr Replica Pesek Eu2 07 • Senda Sm Drd Pro Eu2 05-11 (R.O. 96921R)



24 639 0110 

100: Atlantis 4T 04-06 • Boulevard 4T 10-11 (R.O. AP8551026)



24 639 0160 

50: Atlantis Lc 99-01 00G03901991 Atlantis 99-01 • Hunter 96-97 • Paddock 98-99 • Predator Lc 98-01 • Predator o2 98-01 (R.O. 00G03901991)



24 639 0220 

125-250: Rambla E3 2Ver 08 • Rambla 08-09
250: Gp1 Low Seat Eu3 07-08 • Gp1 06-07
300: Rambla 10 (R.O. 58142R)



GILERA

24 639 0010 

50: Dna 00-02 • Dna 05-07 • Dna Gp Experience 03-04 • Easy Moving 95-96 • Ice 01-05 • Runner 97-00 • Runner Poggiali 02 • Runner Sp 02-06 • Runner Sp 07 • Runner Sp 10 • Runner Sp Spec Edit 07 • Runner Sp St & Simon 08-09 • Stalker 97-09 • Stalker Naked 08 • Stalker Special Edition 07-08 • Storm 94-95 • Storm Eu2 07 • Typhoon 94-97 • Typhoon X 98-99 • Typhoon Xr 00 (R.O. 82530R)



24 639 0080 

50: Runner Purejet 02-06 • Runner Purejet 07 • Runner Purejet 10 • Runner Purejet 02-10 • Runner Purejet St 08 • Runner Purejet St 06-08 (R.O. 96921R)



24 639 0090 

125: Dna 01 • Nexus Eu3 07-08 • Runner Vx 05-06 • Runner Vx 4T Eu3 07 • Runner Vx 4T St Eu3 08-09 • Runner Vx Race 06 • Runner Vx Sc 06-07 • Runner Vx-Vxr 00-04
200: Runner Vxr 05-06 • Runner Vxr 4T St Eu3 08 • Runner Vxr Eu3 07 • Runner Vxr Race 06 (R.O. 82611R)





MOTORINI AVVIAMENTO STARTER MOTORS

GILERA

24 639 0110 

125: Runner Fx-Fxr 125-180 97-02 • Typhoon 95-98 • Typhoon X-Xr 99-00 (R.O. 289094)



24 639 0220 

125: Nexus Eu3 ie 08-10
250: Nexus Eu3 06-07 • Nexus Sp Eu3 06-07
300: Nexus Eu3 06-10 (R.O. 58142R)



24 639 0230 

500: Fuoco Eu3 07-11 • Nexus Eu3 06-11 • Nexus Sp Eu3 06-07 • Nexus 03-05 (R.O. 82699R)



HONDA

24 639 0240 

250: Cn



24 639 0200 

250: Foresight (R.O. 31200-KAB-018)



24 639 0300 

125-150: Sh • @ • Dylan • Phanteon 4T • Psi (R.O. 31200-KGF-901)



24 635 0130 

ANELLO PORTA SPAZZOLE - BRUSH
125-150: Sh • @ • Dylan • Phanteon 4T • Psi



24 635 0340 

ANELLO PORTA SPAZZOLE - BRUSH
125: Cg Es 04-07 • Cg M 01 • Nx Transcity 89-97 • XLR R 98 • Xr L 03-06 • CLR Cityfly 98 • **200:** Trx 90-97 • **300:** Trx Ex 93-08 • **350:** TxS 88-93 • **230:** Crf F 03-10 • **250:** Cn 88-89 • Cbf 04-06 • Fes Foresight 98-05 • Nss Jazz 01-04 • Nss X-Ex Forza 05-07 • Nx Dominator 88-93 • **400:** Trx X 09 • Trx Ex 03-08 • FL R 89-90 • **750:** Cb F2 Seven Fifty 92-01 • Vfr C/C2 Shadow 93-02 • Vfr F 88-97 (R.O. 31206-KW1-901 (31206-KS5-901/31206-MR7-008))



24 639 0410 

SPAZZOLE - BRUSH
150: Sh i 07>



24 639 0420 

SPAZZOLE - BRUSH
300: Sh i 08>





ITALJET

24 639 0150 

125: Millennium
150: Millennium
(R.O. 4874800179)



24 639 0160 

50: Formula • Torpedo 2T (Motore Morini)
125: Formula
(R.O. 337200050)



24 639 0190 

250: Jupiter



KYMCO

24 639 0010 

50: Cx 93 • Cx Super 94-97 • Dj W 94-00 • Dj X 91-92 • Djy 93 • Fever Zx 99-00 • Fever Zx Eu2 03-04 • K12 95-00 • Kb 95-00
(R.O. 104002)



24 639 0120 

50: B&w 02 • B&w Eu2 03 • Dink Classic Eu2 03 • Dink Lc 98-02 • Filly 98-00 • Heroism 95-97 • Kxr 04 • Maxxer 05 • Mxer 02-03 • Mxer Eu2 04 • Mxu 06-07 • Mxu Sr 06 • People 99-00 • People 04 • People Eu2 03 v People Eu2 08 • People Eu2 11 • People S 05-08 • Sniper 93 • Sniper Dd 94-96 • Super 9 00 • Super 9 Sport Eu2 03-04 • Top Boy 97-00 • Vitality 2T 04 • Yup 02 • Yup Eu2 03
(R.O. 104202)



24 639 0130 

50: Agility 2T R16 10 • Agility 4T R10 07-08 • Agility 4T R12 07-08 • Agility Rs Naked 2T 10 • Dink 50 4T 07 • Sento 08
(R.O. 107242)



24 639 0250 

125: Grand Dink
(R.O. 00128751 31210-KKC3-90C)



24 639 0252 

125: Grand Dink
(R.O. 00128751 • 31210-KKC3-90C)
Di primo equipaggiamento - *Oem quality*



24 639 0272 

250: B&w Eu 2 03 • B&w 00 • Gran Dink Eu2 03-04 • Gran Dink 01-02 • People Lc 03-04 • People S i 07 • People S 06 • X Citing i 06-07 • X Citing 05 • Yup 03
300: G-Dink 12 • People S i 08 • X Citing i R 08-09 • X Citing I 08
(R.O. 00128750)
Di primo equipaggiamento - *Oem quality*





MOTORINI AVVIAMENTO

STARTER MOTORS

KYMCO

24 639 0140



125: Agility Rs 09 • B&w 00 • B&w Eu2 03-04 • Dink 97-98 • Dink Classic 02 • Dink Classic Eu2 03 • Dink Lx 98-00 • Heroism 95-97 • Movie 99-00 • Movie Eu3 06-07 • Movie XL 01 • Movie XL Eu2 03-04 • People 99-00 • People Eu2 03 • People Eu3 07-08 • People Eu3 11 • People S 05 • People S Dd Eu3 07-08 • Vivio 00
150: Heroism 95-97 • Movie 150 Eu3 06-07
200: People S 05 • People S 200I 07 (R.O. 00128741 31200-KUDU-9000)

24 639 0142



CON CAVO - WITH CABLE

125: Agility Rs 09 • B&w 00 • B&w Eu2 03-04 • Dink 97-98 • Dink Classic 02 • Dink Classic Eu2 03 • Dink Lx 98-00 • Heroism 95-97 • Movie 99-00 • Movie Eu3 06-07 • Movie XL 01 • Movie XL Eu2 03-04 • People 99-00 • People Eu2 03 • People Eu3 07-08 • People Eu3 11 • People S 05 • People S Dd Eu3 07-08 • Vivio 00
150: Heroism 95-97 • Movie 150 Eu3 06-07
200: People S 05 • People S 200I 07 (R.O. 00128741 31200-KUDU-9000)
 Di primo equipaggiamento - *Oem quality*

24 639 0292



125: Downtown 125i 09 • People Gt 10 (R.O. 00131063 31210-LEB1-90A)
 Di primo equipaggiamento - *Oem quality*



24 639 0322



200: Downtown i 10 • People Gti 10-14
300: Downtown i 09 • Downtown Abs i 11 • Downtown Abs 10 • Downtown i 11 • K-Xct i Abs 14 • K-Xct i 12 • People Gti Abs 12-14 • People Gti 10-14 • Downtown i Abs 15 (R.O. 00131056)

24 639 0382



400: X Citing i Abs 14-15 • X Citing i 13 (R.O. 00131156)



MALAGUTI

24 639 0020



50: Centro Base 93-94 • Centro SL 94-98 • Centro SL Kat 99-00 • Ciak Master 04 • Ciak Master Eu2 06 • Ciak Mono Eu2 03 • Ciak Mono Eu2 2.3 03 • F10 Jet Line 92-98 • F10 Kat 99-00 • F10 Rst Eu1 01-02 • F10 Rst Eu2 02-03 • F10 Rst Eu2 06 • F10 Rst Eu2-2.3 03-04 • F12 Aria Rst Eu2 06 • F12 Lc Rst Eu2 06 • F12 Phantom 94-98 • F12 Phantom Eu1 99-00 • F12 Phantom Lc 94-98 • F12 Phantom Lc Eu1 99-00 • F12 Phantom Lc Rst Eu1 01-02 • F12 Phantom Lc Rst Eu2 02 • F12 Phantom Lc Rst Eu2-2.3 03-04 • F12 Phantom Lc Twin Disks 98 • F12 Phantom

Rst Eu1 01-02 • F12 Phantom Rst Eu2 02 • F12 Phantom Rst Eu2-2.3 03-04 • F12R Phantom Lc 07-09 • F15 Fire Fox Air Cooled 05-06 • F15 Fire Fox Eu2 02-03 • F15 Fire Fox Rst Eu2-2.3 03-04 • F15 Fire Fox Twin Disks & Special 98-99 • F15 Fire Fox Twin Disks Digit Kat 98-00 • F15 Lc Rst Eu2 04-05 • F15 Lc-Tds Rst Eu1 01 • Grizzly 4 Wheels 04-09 • Yesterday • Yesterday Euro 97-00 (R.O. 2404400)

24 639 0060



24 639 0150



125: Madison 99-01 • Madison R Rst 02
150: Madison T 99-01 (R.O. 74800300)





MALAGUTI

24 639 0160 

50: Crosser CR1 95-98
(R.O. 6211800)



24 639 0190 

250: Password Eu3 07-08 • Password 05-06 •
Madison S 99-01
(R.O. 74800500)



24 635 0340 

250: Madison S 99-01
(R.O. 94800200)



MBK

24 639 0020 

50: Yh Flipper 01-02
Yh Flipper Catalitico 99-00
(R.O. 4CUH18001000)



24 639 0150 

125: Xq Thunder 01-02 • Yp Skyliner 01-02
150: Xn Doodo 01-02 • Xq Thunder 01-02 • Yp
Skyliner 01-02
180: Yp E Skyliner 03
(R.O. 5DSH18000000)



24 639 0190 

250: Yp Skyliner Abs 03 • Yp Skyliner 00-03
300: Xc Kilibre 03
(R.O. 4HC81890000)



PEUGEOT

24 635 0340 

MBK 250: Yp Skyliner Abs 03 • Skyliner 00-03 •
300: Xc Kilibre 03
(R.O. 3KS818400000)



24 639 0040 

50: Elyseo 99 • Looxor 01-03 • Ludix 10 Sp
Blaster 05-06 • Ludix 10 Trend • Snake 04 •
Ludix 14 Elegant 04 • Metal-X 02 • Speedfight
2 Aria 05-06 • Speedfight 2 Lc-Silversport
05-06 • Speedfight Acqua 97-98 • Speedfight
Aria 97-98 • Speedfight Aria Catalitico 99 •
Trekker 98-00 • Trk2 Wrc 04-06 • Vivacity 99 •
Vivacity Catalitico 99-02 • Vivacity Vsx-Xr 02-04
• X-Fight 00 • Xrace 03 • Zenith Ln-Ls 97-98 •
Zenith N 97-98
(R.O. 735112)



24 639 0370 

100: Elyseo • Looxor • X-Fight • Viva • Tk Rr
(R.O. 723726)





MOTORINI AVVIAMENTO

STARTER MOTORS

PIAGGIO

24 639 0010



50: Diesis 01 • Fly 2T 05-07 • Fly 2T 10 • Free 92-94 • Free Delivery 00-01 • Free FL 95-02 • Liberty 97-05 • Liberty 2T 06-08 • Liberty 2T Rst 04 • Liberty 2T Sport 06-08 • Liberty Moc 2T 09 • Liberty Ptt Eu2 04-05 • Nrg 94-96 • Nrg Extreme 99-00 • Nrg Mc3 01-04 • Nrg Power Dd 05-06 • Nrg Power Dd 07-09 • Nrg Power Dd Serie Speciale 07-08 • Nrg Power Dt 06 • Nrg Power Dt 07-08 • Nrg Rst Mc2 96-98 • Ntt 95-96 • Sfera 91-93 • Sfera Maquillage 2 94 • Sfera Rst 95-97 • Typhoon 01-08 • Typhoon 09 • Vespa Et2 97-05 • Vespa Et2 Iniezione 97-00 • Vespa Lx 2T 05-08 • Vespa Lx 2T FI 09 • Vespa Lx 2T Touring 10 • Vespa Lxv 2T 06-08 • Vespa Lxv 2T Navy 08 • Vespa S 2T 07-08 • Zip 92-04 • Zip 2T 08-09 • Zip Bimodale 94-97 • Zip Fast Raider 93-94 • Zip Fast Raider Rst 96-97 • Zip Rst 96-99 • Zip Sp 96-04 • Zip Sp Eu2 06-09
(R.O. 82530R)



24 639 0090



125: Beverly 01-03 • Beverly Eu3 07-08 • Beverly Eu3 Mic 07 • Beverly Eu3 Sport 07-08 • Beverly Rst 04-07 • Beverly Tourer Eu3 08-09 • Carnaby 07-09 • Fly 05-07 • Fly Eu3 07-08 • Hexagon Gtx 00 • Liberty 01-02 • Liberty 4T 06-07 • Liberty 4T Eu3 07-08 v Liberty 4T Eu3 Delivery 08 • Liberty 4T Sport Eu3 06-08 • Liberty Moc 4T & Elle 09-10 • Liberty Rst 04-05 • Liberty Rst Ptt 05-06 • Liberty Sport 06 • Mp3 07-08 • Skipper 94-97 • Super Hexagon Gtx 12 01-02 • Vespa Et4 99-02 • Vespa Granturismo 03-05 • Vespa Granturismo 06-07 • Vespa Granturismo Eu3 06-07 • Vespa Gts Eu3 07-09 • Vespa Gtv 07-08 • Vespa Gtv 4T Navy Eu3 08 • Vespa Lx 05-06 • Vespa Lx 4T FL 09 • Vespa Lx Eu3 06-08 • Vespa Lx Eu3 ie 09 Vespa Lx Touring 10 • Vespa Lxv 4T Eu3 06-09 • Vespa Lxv 4T Navy Eu3 08 • Vespa Lxv ie 4T 10 • Vespa S 4T Eu3 07-08 • Vespa S 4T ie 09 • X Evo 07 • X7 Eu3 08 • X8 04-06 • X8 Premium Eu2 06 • X8 Premium Eu3 06-07 v X8 Street Eu2 06-07 • X9 01-02 • X9 Evolution 03 • X9 Evolution 05-06 • X9 Evolution Eu3 07 • Zip 00-02

150: Fly 05-07 • Fly Eu3 08 • Liberty 4T Eu3 08 • Liberty 4T Sport Eu3 08 • Liberty Moc 4T 09 • Vespa Lx 05-06 • Vespa Lx 4T FL 09 • Vespa Lx Eu3 06-08 • Vespa Lx Eu3 ie 09 • Vespa Lx Touring 10 • Vespa S 4T 08-09 • Vespa S 4T ie 09 • X8 Street Eu2 06-08

180: X9 Amalfi 00-03

200: Carnaby 07-08 • Liberty 06 • Liberty 4T Eu3 07-08 • Liberty 4T Sport Eu3 06-07 • Liberty Rst 04 • Liberty Sport 06 • Vespa Granturismo 06-07 • X8 05-07 • X9 02-03 • X9 Evolution 03
(R.O. 82611R)



24 639 0100



125: Hexagon Lx4 98-99 • Liberty 98-00 • Sfera 95-97 • Vespa Et4 96-98
(R.O. 2947365)



24 639 0110



100: Fly 4T 08 • Zip 4T 06-10 • Free 02-03
125: Hexagon 94-97 • Hexagon Lx-Lxt 98-99 • Skipper Lx 98-99
(R.O. 289094)



24 639 0240



250: Hexagon Gt • Super Hexagon Gtx (Motore Honda - Engine Honda)
(R.O. 495180)



24 639 0080



50: Fly 4T 05-08 • Fly 4T Motore Chn 06-07 • Liberty 4T 00-02 • Liberty 4T 05-08 • Liberty 4T Delivery Tnt 09 • Liberty 4T Rst 04 • Liberty 4T Sport 06-08 • Liberty Moc 4T & Elle 09-10 • Nrg Power Purejet 04-05 • Nrg Power Purejet 06-08 • Nrg Purejet 02-04 • Nrg Purejet 10 • Puch P1-Tre 93-98 • Vespa Et4 00-05 • Vespa Lx 4T 05-08 • Vespa Lx 4T-4V 09 • Vespa Lx 4T-4V Touring 10 • Zip 4T 00-08 • Zip Rst 96-99 • **80:** Skr City 99

500: X9 01-02 • X9 Evolution 03-07 • X9 Evolution Abs 06-07

Cavalletto centrale - Central stand

(R.O. 96921R)



24 639 0230



400: Beverly Eu 3 06-07 • Beverly Tourer Eu 3 08-10 • Mp3 ie Lt - Mp3 ie Lt Sport 08-10 • Mp3 ie Lt Touring 11 • Mp3 Mic 08-11 • Mp3 RL Touring 11 • Mp3 07-08 • X Evo 07-11 • X8 Eu 3 06-08

500: Beverly Cruiser 07-11 • Beverly Eu 3 06-08 • Beverly 02-06 • Mp3 Lt Sport - Bussiness 11 • Mp3 RL Sport 11 • X9 Evolution Abs 06-07 • X9 Evolution 03-07 • X9 01-02



24 639 0220



125: Vespa Gts 4T ie Super 09-11 • X7 Evo ie Eu 3 09-10

250: Beverly Cruiser 07-09 • Beverly Eu 3 Mic 07 • Beverly ie Eu 3 06-08 • Beverly Sport 06-08 • Beverly Tourer Eu3 08-09 • Beverly 06-07 • Carnaby 08 • Mp3 Lt 09 • Mp3 Mic 08-09 • Mp3 06-08 • Vespa Gts-Gts Abs 05-10 • Vespa Gtv 4T Navy Eu3 08 • Vespa Gtv 06-09 • X Evo 07-11 • X7 Eu3 08 • X8 Eu3 05-08 • X9 Evolution 06 300: Beverly Rst 4T 4V ie Eu3 10-11 • Beverly Tourer Eu3 09-10 • Carnaby Cruiser 09-11 • Vespa Gts ie Touring 11 • Vespa Gts Super Sport 10-11 • Vespa Gts Super 08-11 • Vespa Gtv 4T 4V ie 10-11 • Vespa Gtv Via Montenapoleone 10 • X7 Evo ie Eu 3 09-10





PIAGGIO

24 639 0071 

50: Ape FL • FL2 89-95 • Ape FL3 Europa 96-99 • Ape Rst Mix 99-05 • Ape Tm P 85-89 • Vespa FL 90 • Vespa FL2 Automatica 90-91 • Vespa FL2 Hp 91-97 • Vespa N 89-90 • Vespa Pk 50-125 82-84 • Vespa Pk S 50-125 Automatica 84-89 • Vespa Pk XL 85-88 • Vespa Pk XL Plurimatic 85-90 • Vespa Pk XL Rush 88-89
125: Vespa FL 89-90
(R.O. 1791165)



24 639 0261 

125-150: Vespa Px- Cosa - VNX2-VLX2-VSX2-VLR1T-VLR
(R.O. 249235)



24 639 0400 

PIAGGIO 125: Vespa Sprint 4T 3V ie 14-15 • Vespa S 4T 3V ie 12 • Vespa Lx Primavera 4T 3V ie 13-15 • Vespa Lx 4T 3V ie Touring 12-13 • Vespa 946 4T 3V Abs Armani 15 • Vespa 946 4T 3V Abs 13-15 • Mp3 ie 08-09 • Mp3 Ibrido 09-10 • Liberty 4T 3V ie E3 13-14 • Fly 4T 3V ie Eu3 Lem 12-13 • Fly 4T 3V ie E3 Dt 13-15 • 150: Vespa Sprint 4T 3V ie 15 • Vespa Primavera 4T 3V 13-15 • Vespa Lx 4T 3V ie Touring 12-13 • Vespa Lt 4T 3V ie 12-13 • Vespa Gts Super ie 4T 3V Au, Ex, Jp, Ri, T,V 14-15 • Liberty 4T 3V ie E3 13-14 • 300: Mp3 ie Mic 11
(R.O. 58294R)



12 187 0500 

KIT MINUTERIA REVISIONE
PIGNONE AVVIAMENTO
STARTER PINION SERVICING KIT
Vespa 50 Pk • FL • FL2 Automatica • FL2 Hp • N Pk Automatica • Pk XL Plurimatic • Rush • Pk XL Vespa 125 FL • Pk XL - (R.O. 249482)



24 635 0030 

ANELLO PORTASPAZZOLE
BRUSH HOLDER
Vespa Pk 50 • Ape 50
(R.O. 179755-291383)



SUZUKI

24 639 0160 

50: Aj ZZ Sepia S 95-97 • Tr S Street Magic 98 • Ay Ayw Katana V-Y 97-00 • Ux Zillion 99
(R.O. 31100-36C02-000)



24 639 0280 

125-150: Uc Epicuro X-K1 99-01 • Uh Burgman K2-K6 02-06 - 250: An Burgman K3-K6 03-06 • An Burgman W-K2 98-02 - 400: An Burgman K3-K6 03-06 • An Burgman W-K2 99-02
(R.O. 31100-14F01-000)



SYM

24 639 0180 

125-150: Eu Mx E2 03-04 • Eu Mx 02 • Shark 99-02



24 639 0120 

50: Jet 99 • Jungle 99 • Mask Eu2 03-04 • Mask 00-01 • Red Devil 99 • Super Fancy 98-00
(R.O. 31200GAK900)



24 639 0350 

125: Gts Joymax 06-07 • Hd Eu3 07-08 • Hd Evo Eu3 07-11 • Hd Evo Tamburo Eu3 08-09 • Hd Evo 05-06 • Hd2 11-14 • Joyride Eu2 05-06 • Joyride Eu3 07 • Joyride Evo 09-14 • Joyride 01-02
150: Joyride 01 - 02 - (R.O. 31200H9A000)





MOTORINI AVVIAMENTO

STARTER MOTORS

SYM

24 639 0360



125: Hd Eu2 03-04
200: Hd Eu2 03-04 • Hd Eu3 i 07 • Hd Evo 05-12 • Hd2 i 11-14 • Joyride 03-13
(R.O. 31200HLA000)



YAMAHA

24 639 0020



50: Yh Why 01-02 • Yh Why 06 • Yq Aerox 97-11
(R.O. 4CUH18001000)



24 639 0150



125: Xq Maxster 01-02 • Yp E Majesty 01-06
150: Xn Teos 01-02 • Xq Maxster 01-02 • Yp Majesty 01-02
180: Yp E Majesty 03-05
(R.O. 5DSH18000000)



24 639 0190



250: Yp Majesty Abs 03 • Yp Majesty Dx 98-99
Yp Majesty 96-03 • Vp X-City 07-12 • Yp R X-Max 05-09 • Xc Versity 04-06
300: Xc Versity 03
400: Yp R X-Max Momodesign 14 • Yp R X-Max 13-15 • Yp Ra X-Max Abs 14-15 • Yp Ra X-Max Momodesign Abs 14
(R.O. 1SDH18000000 • 1COH18000000)



24 639 0340



125: Vp X-City 08-11 • Yp R X-Max Abs 11 • Yp R X-Max 08-14 • Yp Ra X-Max Abs 13-14
(R.O. 1B9-H1800-01)



24 639 0390



125: Xc R Majesty S 14 • Hw Xenter 12-15
150: Hw Xenter 12-15
(R.O. 52SH18000000)



24 635 0270



ANELLO PORTASPAZZOLE - BRUSH HOLDER

500: T-Max 01-07
(R.O. 3HE818400000)



24 635 0340



ANELLO PORTASPAZZOLE - BRUSH HOLDER

250: Vp X-City 07-12 • Ybr 07-11 • Yp Majesty Abs 03 • Yp Majesty Dx 98-99 • Yp Majesty 96-03 • Yp R X-Max 05-09 • Vp X-City 09-13 • Yp R Black X-Max 09 • Yp R X-Max Sport 11-12 • Yp R X-Max 10-14 • Yp Ra X-Max Abs 11-14 • **300:** Xc Versity 03-06 • **400:** Yp Majesty Abs 07-11 • Yp Majesty 04-11 • Yp R X-Max Momodesign 14 • Yp R X-Max 13-15 • Yp Ra X-Max Abs 14-15 • Yp Ra X-Max Momodesign Abs 14 • **535:** Xv Dx Virago 99-01 • Xv Virago 90-98 • **600:** Xj N 95-01 • Xj S Diversion 92-02 • **650:** Xvs A Drag Star Classic 98-06 • Xvs Drag Star 97-02 • **750:** Fz 89-90 • Yzf R 93-96 • Yzf Sp 93-95 • **1000:** Fzr 89-95 • Gts A Abs 93 • Gts 93 • Yzf R Thunder Ace 96-00
(R.O. 3KS818400000 • 1COH18400000)





APRILIA

24 635 0052 

6 POLI CON PIASTRA Ø 94 MM
6 POLES WITH PLATE Ø 94 MM

50: RS 06-10 (motore Derbi)
(R.O. 82852R)

Di primo equipaggiamento – *O.E.M. Quality*



24 635 0062 

12 POLI Ø 84 MM CON PICK-UP
12 POLES Ø 84 MM WITH PICK-UP

50: Scarabeo 4T 02-06 • Scarabeo 4T Restyling Euro3 06-09 • Sport City One 4T 08-10

100: Scarabeo 4T 01-04 e 2010 • Scarabeo Net • Euro3 • Restyling 06-10
(R.O. AP8551076)

Di primo equipaggiamento – *O.E.M. Quality*



24 635 0072 

6 POLI Ø 96 MM
6 POLES Ø 96 MM

50: SR/R 04-10 • Sport City One • Street 2T 08-10 • SR Street 03-10 • SR R Factory 10 (carburatore) • Scarabeo • Street • Net 2T 05-11

(R.O. 830296)

Di primo equipaggiamento – *O.E.M. Quality*



24 635 0082 

12 POLI Ø 84 MM CON PICK-UP
CON CONNETTORE A 3 PIN
12 POLES Ø 84 MM WITH PICK-UP
WITH CONNECTOR 3 PINS

50: Scarabeo Quattro 4T • 4V 09-10 • Scarabeo 4T-4V 10 • Scarabeo 4T Net 10
(R.O. 833632)

Di primo equipaggiamento – *O.E.M. Quality*



24 635 0092 

18 POLI Ø 95 MM CON PICK UP
18 POLES Ø 95 MM WITH PICK UP

250: Atlantic 04-06 (carburatore) • Scarabeo 04-06 (carburatore)

(R.O. AP 8577045)

Di primo equipaggiamento – *O.E.M. Quality*



24 635 0102 

18 POLI Ø 94,7 MM CON PICK UP A 2 CAVI
18 POLES Ø 94,7 MM WITH PICK UP 2 CABLES

250: Atlantic ie 06-09 • Scarabeo Light 06-08 • Sport City Cube 08-10

(R.O. 638848)

Di primo equipaggiamento – *O.E.M. Quality*



24 635 0112 

18 POLI Ø 96 MM
18 POLES Ø 96 MM

400-500: Atlantic Sprint 05-08 • Scarabeo Light 06-08

500: Atlantic 01-04 • Scarabeo 03-06
(R.O. AP8560100)

Di primo equipaggiamento – *O.E.M. Quality*



24 635 0122 

18 POLI Ø 96 MM CON PICK UP 2 CAVI
18 POLES Ø 96 MM WITH PICK UP 2 CABLES

400-500: Scarabeo Light 06-08
(R.O. 58108R)

Di primo equipaggiamento – *O.E.M. Quality*



24 635 0142 

12 POLI TRIFASE 150 W Ø 84 MM
12 POLES THREEPHASES 150 W Ø 84 MM

125: Mojito 08 • Sport City One 4T Eu3 08-10 • Sr Motard 12

(R.O. 584690)

Di primo equipaggiamento – *O.E.M. Quality*





DERBI

24 635 0052



6 POLI CON PIASTRA Ø 94 MM
6 POLES WITH PLATE Ø 94 MM

50: Senda R/Sm Drd Pro Eu2 05-09 (con avviamento elettrico) • Senda Hyp Drd Evo Limited Ed. 8 • GPR Nude/Nude Sport 06-07 • Gpr Racing Eu2 06-07 • Gpr Replica E2/R Eu2 06-09 • Gpr Nude Tuning 06-09 • Gpr R Eu2 08-09 (R.O. 47065/82852R)
Di primo equipaggiamento – *O.E.M. Quality*



24 635 0062



12 POLI Ø 84 MM CON PICK-UP
12 POLES Ø 84 MM WITH PICK-UP

50: Atlantis - Boulevard 4T - Eu2 04-07
100: Atlantis 4T 04-06 (R.O. 969228)
Di primo equipaggiamento – *O.E.M. Quality*



24 635 0072



6 POLI Ø 96 MM
6 POLES Ø 96 MM

50: GP1/Eu2 01-09 • Atlantis 20 • Bullet • City • Red Bullet • 2 Chic • Eu2 02-09 • Sonar 2T 09-10 • Boulevard 2T 09-10 (R.O. 830296)
Di primo equipaggiamento – *O.E.M. Quality*



24 635 0092



18 POLI Ø 95 MM CON PICK UP
18 POLES Ø 95 MM WITH PICK UP

250: GP1 06-07 Carburatore - *Carburetor* (R.O. 58048R)
Di primo equipaggiamento – *O.E.M. Quality*



24 635 0102



18 POLI Ø 94,7 MM CON PICK UP A 2 CAVI
18 POLES Ø 94,7 MM WITH PICK UP 2 CABLES

250: GP1 Eu3 • Racing 07-09
250-300: Rambla 08-10 (R.O. 638848)
Di primo equipaggiamento – *O.E.M. Quality*



24 635 0142



12 POLI TRIFASE 150 W Ø 84 MM
12 POLES THREEPHASES 150 W Ø 84 MM

125-150: Boulevard Eu3 04-10 • Boulevard 4T Eu3 08-12 • Gp1 Eu2 06 • Sonar 4T 09-11
200: Boulevard 05 (R.O. 584690)
Di primo equipaggiamento – *O.E.M. Quality*



GILERA

24 635 0042



6 POLI Ø 96 MM - 6 POLES Ø 96 MM

50: Easy Moving 95-96 • Runner 97-00 • Stalker 97-04 • Storm 94-95 • Typhoon • X • XR 94-00 (R.O. 830294)
Di primo equipaggiamento – *O.E.M. Quality*



24 635 0072



6 POLI Ø 96 MM - 6 POLES Ø 96 MM

50: Dna Gp/Experience 00-> • Ice 50 01-> • Runner FL • Poggiali • SP • Race • SC • ST 02-10 • Stalker Naked 03-10 • Storm Eu 2 07-09 • Typhoon 01-10 (R.O. 584525/639865/830296)
Di primo equipaggiamento – *O.E.M. Quality*



24 635 0092



18 POLI Ø 95 MM CON PICK UP
18 POLES Ø 95 MM WITH PICK UP

250: Oregon Atv (R.O.58048R/584849)
Di primo equipaggiamento – *O.E.M. Quality*





GILERA

24 635 0102 

18 POLI Ø 94,7 MM CON PICK UP A 2 CAVI
18 POLES Ø 94,7 MM WITH PICK UP 2 CABLES
125: Nexus Eu3 ie 08-10
250: Nexus Eu3 06-07
300: Nexue Eu3 08-10
(R.O. 58070R/58112R/638848)
Di primo equipaggiamento – *O.E.M. Quality*



24 635 0112 

18 POLI Ø 96 MM
18 POLES Ø 96 MM
500: Nexus 03-05 • Nexus Eu3 06-10
• Nexus SP Eu3 04-07
(R.O. 58080R)
Di primo equipaggiamento – *O.E.M. Quality*



24 635 0122 

18 POLI Ø 96 MM CON PICK UP 2 CAVI
18 POLES Ø 96 MM WITH PICK UP 2 CABLES
500: Fuoco Eu3 07-11
(R.O. 58108R)
Di primo equipaggiamento – *O.E.M. Quality*



24 635 0142 

12 POLI TRIFASE 150 W Ø 84 MM
12 POLES THREEPHASES 150 W Ø 84 MM
125: Runner Vx Race 06 • Runner Vx Sc 06-07 •
Runner Vx 05-06
200: Runner Vxr 4T St Eu3 08-11 • Runner Vx
Race 06 • Runner Vx R 05-06
(R.O: 584690)
Di primo equipaggiamento – *O.E.M. Quality*



ITALJET

24 635 0062 

12 POLI Ø 84 MM CON PICK-UP
12 POLES Ø 84 MM WITH PICK-UP
50: Torpedo 4T
Di primo equipaggiamento – *O.E.M. Quality*



24 635 0072 

6 POLI Ø 96 MM
6 POLES Ø 96 MM
50: Jet Set • Torpedo 2T (motore Piaggio)
Di primo equipaggiamento – *O.E.M. Quality*





KYMCO

24 635 0152 

8 POLI 12 V CON PICK UP Ø 88 MM
8 POLES 12 V WITH PICK UP Ø 88 MM
50: Agility 4T R10 06-08 • Agility 4T R12 07-08
Dink 4T 07 • People S 4T 06-08 • Sento 08 •
Vitality 4T 04
(R.O. 00103025 • 31120-LBD6-E0A)
Di primo equipaggiamento – *O.E.M. Quality*



24 635 0162 

8 POLI 12 V CON PICK UP Ø 88 MM
8 POLES 12 V WITH PICK UP Ø 88 MM
125: Agility 4T Eu3 06-08
(R.O. 00128172 • 31120-KUDU-90A)
Di primo equipaggiamento – *O.E.M. Quality*



24 635 0172 

8 POLI 12 V CON PICK UP Ø 88 MM
8 POLES 12 V WITH PICK UP Ø 88 MM
50: People Eu2 03-11 • People S 05-08
People 99-04
(R.O. 00103300 • 31120-KFA6-900)
Di primo equipaggiamento – *O.E.M. Quality*



24 635 0182 

8 POLI 12 V CON PICK UP Ø 88 MM
8 POLES 12 V WITH PICK UP Ø 88 MM
125: People 125-150 Eu2 03 • People 125-150
99-00
(R.O. 00123300 • 31120-KHB4-90A)
Di primo equipaggiamento – *O.E.M. Quality*



24 635 0192 

12 POLI 12 V Ø 88,4 MM
12 POLES 12 V Ø 88,4 MM
125: People S DD Eu 3 07-08 • People S 05
200: People S 05
(R.O. 00128184 • 31120-LCD3-E0B)
Di primo equipaggiamento – *O.E.M. Quality*



24 635 0202 

10 POLI 12 V Ø 93 MM
10 POLES 12 V Ø 93 MM
125: B&w 125-150 Eu2 03-04 • B&w 125-150
00 • Dink 125 Eu3 06-07 • Dink 125-150 97-98 •
Dink Classic 125-150 Eu2 03 • Dink Classic 125-
150 02 • Dink Lx 125-150 98-00 • Grand Dink
125-150 Eu2 03-04 • Grand Dink 125-150 01-02
(R.O. 00128947 • 31120-KBE-9000)
Di primo equipaggiamento – *O.E.M. Quality*



24 635 0250 

18 POLI 12V CON PICK UP Ø 91,8MM
18 POLES 12V WITH PICK UP Ø 91,8MM
250: Bet & Win • Gran Dink • People S
Yup • X Citing
(R.O. 00128937 • 00128944 • 00169320
•00169140 • 31120-KKC4-90A)



24 635 0240 

11 POLI 12V CON PICK UP
11 POLES 12V WITH PICK UP
200: Dink Classic 04
(R.O. 00128039 • 31120-KKC2-81A)





MALAGUTI

24 635 0062 

12 POLI Ø 84 MM CON PICK-UP
12 POLES Ø 84 MM WITH PICK-UP
50: Centro 4T 08 • Ciak Master 4T 05-06 •
Centro SL 4T 10
(R.O. 48201400)
Di primo equipaggiamento – *O.E.M. Quality*



24 635 0092 

18 POLI Ø 95 MM CON PICK UP
18 POLES Ø 95 MM WITH PICK UP
250: Madison RS 04-05 • F12 Phantom Max
(R.O. 48200800)
Di primo equipaggiamento – *O.E.M. Quality*



24 635 0102 

18 POLI Ø 94,7 MM CON PICK UP A 2 CAVI
18 POLES Ø 94,7 MM WITH PICK UP 2 CABLES
250: Madison3 06-09
(R.O. 48202000)
Di primo equipaggiamento – *O.E.M. Quality*



24 635 0112 

18 POLI Ø 96 MM - 18 POLES Ø 96 MM
500: Spidermax Gt 04-05
• Spidermax Gt Eu3 06
(R.O. 40201900)
Di primo equipaggiamento – *O.E.M. Quality*



24 635 0122 

18 POLI Ø 96 MM CON PICK UP 2 CAVI
18 POLES Ø 96 MM WITH PICK UP 2 CABLES
500: Spider Max RS 08
(R.O. 48202400)
Di primo equipaggiamento – *O.E.M. Quality*



24 635 0230 

16 POLI - 16 POLES
125: Madison R Restyling Eu2 02-04 • Madison
99-01 • Madison Max 03
150: Madison T 99-01
(R.O. 78201900)



MBK

24 635 0210 

50: Evolis 92-95 • Flipper 98-02 • Ovetto 97-01 •
Nitro 97-02
(R.O. 3KJ8556000)



24 635 0230 

16 POLI - 16 POLES
125: Doodo 00-01 • Thunder 01-02
Skyliner 98-03
150: Doodo 01-02 - Thunder 01-02
Skyliner 00-02
180: Skyliner 03
(R.O. 5DS8511000)





STATORI - VOLANI
STATORS - MAGNETOS

PEUGEOT

24 635 0102 

18 POLI Ø 94,7MM CON PICK UP 2 CAVI
18 POLES Ø 94,7MM WITH PICK UP 2 CABLES
250: Satelis • Geopolis
(R.O. 758741)
Di primo equipaggiamento – *O.E.M. Quality*



24 635 0122 

18 POLI Ø 96 MM CON PICK UP 2 CAVI
18 POLES Ø 96 MM WITH PICK UP 2 CABLES
400-500: Satelis • Geopolis
(R.O. 759735)
Di primo equipaggiamento – *O.E.M. Quality*



24 635 0351 

50: Ludix



PIAGGIO

24 635 0042 

6 POLI Ø 96 MM - 6 POLES Ø 96 MM
50: Free FL • Delivery 95-02 • Liberty 97-05
• Nrg 94-96 • Nrg Extreme 99-10 • Nrg Mc3
01-04 • Nrg Rst Mc2 96-98 • Ntt 95-96 • Quartz
99-96 • Sfera • Rst 91-97 • Zip 92-96
• SP/Rst 96-00 • Zip Fast Raider Rst 96-97
(R.O. 830294)
Di primo equipaggiamento – *O.E.M. Quality*



24 635 0062 

12 POLI Ø 84 MM CON PICK-UP
12 POLES Ø 84 MM WITH PICK-UP
50: Fly 4T (Motore Cinese) 05-10 • Liberty 4T
00-08 • 4T Sport 06-08 • Liberty Rst 04 • Moc 4T
e Elle 09-10 • Liberty 4T Ptt 09-10 • Delivery Tnt
09 • Vespa ET4 00-05 • Vespa Lx 4T 05-08
• Zip 4T 00-10
100: Fly 4T 04-08 • Free 02-03 • Zip 4T 06-10
(R.O. 969228)
Di primo equipaggiamento – *O.E.M. Quality*



24 635 0072 

6 POLI Ø 96 MM - 6 POLES Ø 96 MM
50: Liberty Ptt Eu2 04-> • Liberty 2T Rst • Sport •
Moc 04-10 • Fly 2T • Zip 2T 00-10 • Zip Sp 01-10 •
Nrg Mc 3 Acqua 01-04 • Nrg Power Dd/Dt 05-10
• Diesis • Typhoon X-R 01-10 • Vespa Lx • Lxv • Tou-
ring • FL 2T 05-10 • Vespa S Special 2T 07-10
(R.O. 584525 • 639865 • 830296)
Di primo equipaggiamento – *O.E.M. Quality*



24 635 0082 

12 POLI Ø 84 MM CON PICK-UP
CON CONNETTORE A 3 PIN
12 POLES Ø 84 MM WITH PICK-UP
WITH CONNECTOR 3 PINS
50: Vespa S 4T-4V 08-10 • Vespa LX 4T-4V 09-10
• Vespa LX Touring 4T-4V 10
(R.O. 833632)
Di primo equipaggiamento – *O.E.M. Quality*



24 635 0362 

12 POLI - 12 POLES
50: Ape 09-15
(Dal - From 29-03-11)
(R.O. 642205)



24 635 0013 

6 POLI - 6 POLES
50-125: Vespa Pk S
V5X1T-VMX1T
Modello avviamento elettrico
Electric starter model
(R.O. 199500)





PIAGGIO

24 635 0063



6 POLI - 6 POLES

50-125: Vespa Pk - FL-N-Pk XL Rush - Pk XL
(R.O. 199495)



24 635 0073



5 POLI - 5 POLES

125-150-200: Vespa Px VNX-VLX-VSX
(R.O. 217866)



24 635 0102



18 POLI Ø 94,7 MM CON PICK UP A 2 CAVI
18 POLES Ø 94,7 MM WITH PICK UP 2 CABLES

125: MP3 ie 08-09 • MP3 Ibrido 09-10
250: Beverly Cruiser 07-09 • Euro3 Mic 07 • ie
Eu3 06-08 • Sport 06-08 • Tourer Eu3 08-09
• Carnaby 08 • Mp3 • Mic • Lt 06-09 • Vespa Gt 60
Eu3 06-07 • Gts • Abs 05-10 • Vespa Gtv/4T Navy
Eu3 06-09 • X Evo 07 • X7 Eu3 08 • X8 Eu3 05-08
300 Beverly Tourer Eu3 09-10 • Carnaby Cruiser
09-10 • Vespa Gts Super Sport 10 • Gts Super
08-10 • Gtv Via Montenaepoleone 10
(R.O. 58070R • 58112R • 638848)
Di primo equipaggiamento - *O.E.M. Quality*



24 635 0392



12 POLI - 12 POLES

125: Liberty Ptt 12
(R.O. 643166)



24 635 0220



5 POLI - 5 POLES

125: Vespa Et3 VMB1
(R.O. 186974)



24 635 0292



12 POLI - 12 POLES

125-150: Vespa Px 11-13
(R.O. 642427)



24 635 0142



12 POLI TRIFASE 150 W Ø 84 MM

12 POLES THREEPHASES 150 W Ø 84 MM

125: Liberty Rst Ptt 05-11 • Liberty Sport 06 •
Typhoon 4T Eu3 10-11 • Vespa Gt 06-07

125-150: Fly Eu3 07-11 • Fly 05-07 • Liberty 4T
Eu3 07-08 • Liberty 4T Sport Eu3 06-08 • Vespa
Lx 4T FL 09 • Vespa Lx Eu3 06-08 • Vespa Lx 05-
06 • X8 Street Eu2 06-08

150: Liberty Moc 4T 09-10 • Vespa S 4T 08-09

200: Liberty 4T Eu3/Sport 06-08 • Liberty
Sport 06 • Vespa Gt 06-07

(R.O. 584690)

Di primo equipaggiamento - *O.E.M. Quality*



24 635 0321



12 POLI - 12 POLES

125: Beverly Eu3 Mic 07 • Beverly Eu3 Sport
07-08 • Beverly Eu3 07-08 • Beverly Rst 05-07
• Beverly Tourer Eu3 07-10 • Carnaby 07-10
• Mp3 06-08 • Vespa GT Eu3 06-07 • Vespa
Gts Eu3 07-12 • Vespa Gtv 4T Navy Eu3 08 •
Vespa Gtv 06-08 • X Evo 07-12 • X7 Eu3 08 • X8
Premium Eu2 06 • X8 Premium Eu3 06-07 • X9
Evolution Eu3 07

200: Carnaby 07-08

(R.O. 639727)



24 635 0092



18 POLI Ø 95 MM CON PICK UP
18 POLES Ø 95 MM WITH PICK UP

250: Beverly 04-07 Carburatore - *Carburetor*
• X9 Evolution 04-07

(R.O.58048R • 584849)

Di primo equipaggiamento - *O.E.M. Quality*





STATORI - VOLANI
STATORS - MAGNETOS

PIAGGIO

24 635 0122



18 POLI Ø 96 MM CON PICK UP 2 CAVI
18 POLES Ø 96 MM WITH PICK UP 2 CABLES
400: Beverly Tourer Eu 3 08-10 • Mp3 ie Lt
• Sport 08-10 • Mp3 • Mic 07-09
500: Beverly Cruiser 07-09
(R.O. 58108R)
Di primo equipaggiamento – *O.E.M. Quality*



24 635 0112



18 POLI Ø 96 MM - 18 POLES Ø 96 MM
400: Beverly Eu3 04-07 • Xevo 07-09
• X8 Eu3 06-08
500: Beverly 02-06 • Beverly Eu3 06-08
• X9 01-02 • X9 Evolution 03-07 • X9 Evolution
Abs 06-07
(R.O. 58080R)
Di primo equipaggiamento – *O.E.M. Quality*



SYM

24 635 0260



11 POLI - 11 POLES
125: Hd Eu2 03-04 • Hd Eu3 07-08 • Hd Evo Eu3
05-11 • Joy Ride Eu2-3 03-07 • Joy Ride Evo 09-
13 • Joy Ride 01-02
150: Joy Ride 01-02
200: Hd Eu2 03-04 • Hd Evo Eu2 05-06 • Joy Ride
03 • Joy Ride Eu2 03-04
(R.O. 31120H9A001)



YAMAHA

24 635 0210



50: Why 98-02 • Neo's 97-01 • Aerox 97-02
Aerox R 99-00
(R.O. 3KJ855600000)



24 635 0230



16 POLI - 16 POLES
125: Teo's 00 • Maxster 01-02 • Majesty 98-09
150: Teo's 01-02 • Maxster 01-02 • Majesty 00-02
180: Majesty 03-06
(R.O. 5DS8511000)



24 635 0410



18 POLI - 18 POLES
YAMAHA 400: Yp Majesty Abs 07-08
• Yp Majesty 04-08
(R.O. 5RU814100000)



24 635 0420



18 POLI - 18 POLES
YAMAHA 400: Yp Majesty Abs • Majesty 09-11
(R.O. 34B814100000)



24 635 0330



16 POLI - 16 POLES
500: Xp T-Max Abs 07 • Xp T-Max Black Max-
Night Max 07 • Xp T-Max 04-07
(R.O. 5VU814100100)



24 635 0400



18 POLI - 18 POLES
YAMAHA 500: T-Max 01-03
(R.O. 5GJ814100100)





APRILIA

24 636 0052 

50: Rs4 11
 (R.O. 82852R)



24 636 0062 

50: Scarabeo 4T Restyling Eu3 06-09 • Sport City One 4T 08-10
100: Scarabeo 4T Net / Eu3 10 • Scarabeo 4T Restyling 06-09 • Scarabeo 4T 10-12
 (R.O. 969228+969243)



24 636 0072 

50: SportCity One 2T 08-11
 (R.O. 830296+584526)



DERBI

24 636 0112 

400-500: Atlantic Sprint 05-08 • Scarabeo Light 06-08
 (R.O. 58080R+58040R)



24 636 0122 

400-500: Scarabeo Light 06-08
 (R.O. 58108R+58109R)



24 636 0052 

50: Gpr 2T Eu2 09-10 • Gpr Nude • R Eu2 / Replica 06-08 • Senda Hyp Drd Limited Edition 08 • Senda R Drd Eu2 05-11
 (R.O. 82852R)



24 636 0062 

50: Atlantis 4T Eu2 07 • Atlantis 4T 04-06 • Boulevard 4T Eu2 25 Km/h 09
100: Boulevard 4T 10-11
 (R.O. 969228+969243)



24 636 0072 

50: Atlantis 2T Eu2 07-09 • Atlantis 2T 10 • Atlantis 02 Bullet - City - Redbullet - Two Chic 03-06 • Gp1 Eu2 - Race 05-07 • Gp1 01-03 • Sonar 2T 08 • Variant Sport 2T 12
 (R.O. 830296+584526)



24 636 0092 

250: Gp1 06-07
 (R.O. 58048R+58049R)



26 720 0400



FRENAFILETTI MEDIO (50 ml)

Frenatura di prigionieri, dadi e bulloni non soggetti a smontaggio. Prodotto a bassa viscosità.

Elimina gli allentamenti dovuti a vibrazioni, urti, sbalzi di temperatura. Impedisce la corrosione ed il grippaggio.

THREADLOCKER MEDIUM (50 ml)

Tightening of studs, nuts and bolts not subject to removal. Low viscosity product. Avoid loosening due to vibrations, shocks and temperature changes.

Prevents corrosion and seizing up. Permanent tightening.



26 720 0170



FRENAFILETTI FORTE (10 ml)

Frenatura di prigionieri, dadi e bulloni non soggetti a smontaggio. Prodotto a bassa viscosità.

Elimina gli allentamenti dovuti a vibrazioni, urti, sbalzi di temperatura. Impedisce la corrosione ed il grippaggio. Frenatura permanente.

THREADLOCKER STRONG (10 ml)

Tightening of studs, nuts and bolts not subject to removal. Low viscosity product. Avoid loosening due to vibrations, shocks and temperature changes.

Prevents corrosion and seizing up. Permanent tightening.



26 720 0640



PULITORE FRENI E METALLI (500 ml)

Prodotto spray per la pulizia di freni a tamburo, a disco, pinze e ceppi. Dissolve e rimuove rapidamente grasso, olio, residui, ecc.

MOTORCYCLE BRAKES AND METAL PARTS CLEANER (500 ml)

Spray products for cleaning brake drums, disks, calipers and brake shoes.

Quickly dissolves and removes grease, oil and dirt



26 720 0370



STARTER SPRAY (200 ml)

Applicazione: motore.

Facilita l'avviamento dei motori diesel e benzina durante la stagione invernale, assicurando sempre una rapida accensione anche a temperature molto basse.

Facilitates starting during winter season, always ensuring a fast ignition even at very low temperatures.



26 720 0290



PULITORE INIETTORI BENZINA (250 ml)

Ripristina con effetto immediato l'efficacia del sistema di alimentazione.

Pulisce all'istante e disincrosta gli iniettori. Scioglie depositi e residui nel sistema di alimentazione.

Migliora la combustione

FUEL INJECTORS CLEANER (250 ml)

Restore with immediate effect the efficiency of the power system.

Instantly cleans and descaling the injectors.

Dissolves deposits and wastes in power system improves the combustion



26 720 0420



PULITORE SISTEMA ASPIRAZIONE E CARBURATORE (Conf. 500 ml)

Applicazione: per motori alimentati

a benzina, gpl, metano.

Pulisce ed elimina i depositi nei condotti di aspirazione dell'aria senza la necessità di smontaggio. Scioglie gomme, lacche ed ogni genere di depositi nei corpi farfallati. Indicato per la pulizia dei carburatori.

CLEANER CARBURETOR

It cleans and eliminates debris in the air intake ducts, without having to take them down. It dissolves rubber, build-up and every type of debris contained inside the throttle body. It is suitable for cleaning carburetors.

It restores CO and HC values.

It is suitable for all single-point, multi-point injection engines, throttle bodies and carburetors.



26 720 0130

MOTORSIL D ROSSA pasta per guarnizioni 60 gr
Tenuta di accoppiamenti meccanici, termomeccanici, chimici, elettronici, elettromeccanici, che operino in condizioni particolarmente difficili.

RED MOTORSIL D GASKET SEALANT

Sealant for mechanical, thermo-mechanical, chemical, electronic, electro-mechanical couplings working in particularly difficult conditions.



26 720 0310

MASTICE PER GUARNIZIONE (100 ml)

Posizionamento e fissaggio di ogni tipo di guarnizione tradizionale. Alto potere adesivo, assicura una tenuta perfetta anche su superfici non regolari. Resiste ad oli, benzina, fluidi refrigeranti e alle pressioni.

SEALING GASKET CEMENT (100 ml)

Positioning and securing of any type of standard gasket. High power adhesive, ensuring a perfect seal also on irregular surfaces. Resistant to oils, gas, refrigerant fluids and pressure.



26 720 0710

PASTA MONTAGGIO MARMITTE

EXHAUST-MUFFLER SEALANT

80 ml



26 720 0140

MOTORBLACK NERA pasta per guarnizioni 60 gr

Sigillatura coppa olio motori Fire e giunti dinamici, differenziale, scatola cambio, pompa acqua.

BLACK MOTORBLACK GASKET SEALANT

Sealant for Fire engine oil sump and dynamic joints, differentials, gearboxes, coolant pumps.



26 720 0550

RIPARA METALLO (57 gr)

Pronto all'uso. Forte, facile, rapido. Applicabile anche in presenza di fuoriuscita di acqua. Aderisce anche su superfici bagnate. Non ritira durante l'indurimento. Dopo l'indurimento, può essere trapanato, levigato, lavorato, verniciato. Serve per riparare, ricostruire, otturare, sigillare, stuccare metallo, ferro, alluminio, rame, ottone, bronzo ghisa, piombo e plastiche dure. Ripara tubi, valvole, serbatoi, parti di motore, arnesi di metallo, condotti per l'aria, parti di bici, moto ed auto

METAL REPAIRER (57 gr)

Ready to use. Strong, easy, fast. Applicable even in the presence of leakage of water. Adheres to wet surfaces. Non-shrinking during hardening. After curing, it can be drilled, sanded, machined, painted. It is used to repair, rebuild, fill, seal, caulk metal, iron, aluminum, copper, brass, bronze, cast iron, lead, and hard plastics. Repair pipes, valves, tanks, motor parts, metal tools, air ducts, parts of bicycles, motorcycles and cars.



26 720 0570

CARBOSILICIUM Acqua Grana Fine

(scatola in metallo 70 ml)

Prodotto per la rapida smerigliatura lucidatura delle valvole e dei condotti dei motori a combustione interna. Massimo grado di purezza. Durezza elevatissima. Smerigliatura perfetta.

CARBOSILICIUM WATER (Fine-grain)

Product for the rapid grinding polishing of valves and ducts of internal combustion engines.

Maximum degree of purity. Extreme hardness. Grinding perfect.





STATORI - VOLANI
STATORS - MAGNETOS

PIAGGIO

24 635 0302



125-150: Vespa Px 11-13
(R.O. 642426)



24 635 0312



50: Ape 09-15
(R.O. 642204)



PICK UP

24 617 0010



GILERA 50: Stalker • Runner • Typhoon • X - Xr • Dna

PIAGGIO 50: Sfera Maquillage 2 • Rst • Base • Liberty • Et2 • Quartz • Zip Base • Rst • Fast Rider • Sp • Free • Ntt • Nrg • Rst • Mc2 Extreme • Skr City 80
(R.O. 498865)



24 617 0030



MBK 50: Booster 90> • Road-Spirit • Spirit kat Sorriso • Ovetto • Evolis • Target • Fizz • Forte Nitro • Nitro F1 • Flipper

YAMAHA 50: Aerox • Aerox R • Aerox R kat Why • Why kat • Axis • Bw's Original Original kat • Neo's • Crz • Ctss • Breeze



24 617 0023



PIAGGIO 50: Pk S V5X1T

125-150-150: Vespa Px VNX-VLX-VSX

125-150-200: Cosa VNR1T-VLR1T-VSR1T
(R.O. 196549)



▶ QUADRETTI AVVIAMENTO

IGNITION SWITCHES KIT

▶ SERRATURE

CYLINDER LOCKS

▶ **RMS**
YOUR BEST PARTNER

▶ 
ZADI



QUADRETTI AVVIAMENTO
IGNITION SWITCHES KIT

APRILIA

24 605 0010 

50: Amico 94-98 • Amico GL-GLE 93-95
• Amico Lx- Sport-Cat 92-93
(R.O.8212336)



24 605 0020 

50: Rally 95-03 • Rally Liquid Cooled 96-99
• Sr 93-96 • Sr Liquid Cooled 94-96 • Sr Stealth,
Racing 97-99 • Sr Www 97-01
(kit 3 pezzi - *key set 3 pcs*)
(R.O.8201845)



24 605 0030 

50: Scarabeo 93-05 • Scarabeo Street 05-06 •
Scarabeo Street 2T Rst 06-09
(kit 3 pezzi - *key set 3 pcs*)
(R.O.8201846)



24 605 0040 

50: Gulliver 95-98 • Gulliver Lc 96-98
(kit 3 pezzi - *key set 3 pcs*)
(R.O.8201732)



24 605 0420 

50: Scarabeo 93-05
125: Classic 95-99
(R.O.8201793)



24 605 0440 

50: Scarabeo Ditech Iniezione
(kit 4 pezzi - *key set 4 pcs*)



24 605 0450 

50: Scarabeo Ditech Iniezione 02-06



24 605 0200 

50: Sonic 98-07 • Sonic GP 98-08
(kit 3 pezzi - *key set 3 pcs*)
(R.O.8202014)



24 605 0600 

50: Scarabeo 2T Net 09 • Scarabeo 2T Eu2 Mot.
Piaggio 10-12
(R.O. AP8202452)





APRILIA

24 605 0620 

50: Scarabeo 4T Restyling Eu3 06-09
• Scarabeo 4T-4V 09-12
100: Scarabeo 4T Restyling 06-09
• Scarabeo 4T 10-12
(R.O. 85180R)





24 605 0610 

50: Scarabeo 2T Net 09 • Scarabeo 2T Eu2
Motore Piaggio 10-12
(R.O. 860579)



24 605 0350 

24 605 0351  

125: Leonardo 99-01 • Leonardo St 01-04
(kit 3 pezzi - *key set 3 pcs*)
(R.O.8102923)



24 605 0370 

125: Scarabeo Motore Rotax 99-03 • Scarabeo 03
(kit 2 pezzi - *key set 2 pcs*)
(R.O.8102841)



24 605 0520 

24 605 0522 

125: Sport City 04-06 • Sport City Eu3 06-08
• Sport City Cube 08-10
125-200: Sport City 04-06
250: Sport City Cube 08-10
(R.O. AP8104726)



24 605 0530 

250: Leonardo 99-01 • Leonardo 02-04
• Leonardo St 01 • Leonardo 99-01
(R.O. AP8102877)



24 605 0552 

50: Sr Ditech Eu2 02-03 • Sr H2O Ditech E
Carburatore 00-03 • Sr Street 03-08
(R.O. AP8224343)



24 605 0640 

50: Sr R Factory Carburatore 10-12
• Sr R, R Factory 04-09
(R.O. AP8202419)



24 605 0650 

50: Sr Ditech Eu2 02-04 • Sr H2o Ditech e
Carburatore 00-04
• Sr Street Iniezione 03-12
(R.O. AP8202218-AP8202386)





QUADRETTI AVVIAMENTO
IGNITION SWITCHES KIT



HONDA

24 605 0070 

50: Sky 97
(kit 2 pezzi - *key set 2 pcs*)
(R.O.35010 GCG 930)



24 605 0080 

24 605 0081  
50: Sh 96
100: Sh 96-99
(kit 3 pezzi - *key set 3 pcs*)
(R.O.35010 GBY 910)



24 605 0340 

50: Sh 91-95
(kit 2 pezzi - *key set 2 pcs*)
(R.O.35010GJ3930)





24 605 0380 

125-150: Pantheon 2T 98-02
250: Foresight
(kit 4 pezzi - *key set 4 pcs*)
(R.O.35010KEY900)-(R.O.35010KFG860)







24 605 0390 

24 605 0392  
125-150: Chiocciola 00-06 • Nes 00-07
(kit 3 pezzi - *key set 3 pcs*)
(R.O.35010KGF900)



24 605 0400 

24 605 0401  
24 605 0402  
125-150: Sh 125 01-08
(kit 3 pezzi - *key set 3 pcs*)
(R.O.35010KPR900)



24 605 0470 

125-150: Sh I 01-08
(R.O. 35010-KTF-640)



24 605 0480 

125-150: Dylan 01-06
(R.O. 35010-KPZ-900)



24 605 0540 

125-150: Sh 125 01-08
Kit 3 pz/pcs – Bauletto Ant - Post





KYMCO

24 605 0210 

50: Dj W 94-00 • Dj X 91-92 • Dji 93
(kit 3 pezzi - *key set 3 pcs*)
(R.O.00169007)



24 605 0300 

50: Dink Classic Eu2 03 • Dink Lc 98-02
125: Dink 97-98 • Dink Classic 02
• Dink Classic Eu2 03 • Dink Lx 98-00
200: Dink Classic 04
(kit 3 pezzi - *key set 3 pcs*)
(R.O.00168927)



24 605 0720 



50: Dink Classic Eu2 03 • Dink Lc 98-02
125: Dink 97-98 • Dink Classic 02
• Dink Classic Eu2 03 • Dink Lx 98-00
200: Dink Classic 04
(kit 2 pezzi - *key set 2 pcs*)
(R.O.00168927)



24 605 0630 

50: Agility R16 10-12 • Agility R16 4T 09-12
125: Agility R16 09-12
150: Agility R16 09
200: Agility R16 10-12
(R.O. 00135071)



24 605 0490 

50: People 04 • People 99-00 • People Eu2 03
125: People 99-00 • People Eu2 03
(R.O. 169307)



MALAGUTI

24 605 0090 

50: Centro Base 93-94 • Centro SL 94-98 •
Centro SL Kat 99-00 • F10 Ac 08 • F10 Ac Eco
09 • F10 Jet Line 92-98 • F10 Kat 99-00 • F10
Rst Eu1 01-02 • F10 Rst Eu2 06 • F10 Rst Eu2
02-03 • F10 Rst Eu2-2.3 03-04
(R.O.09002500)



24 605 0100 

50: Crosser Cr1 95-98 • F12 Aria Rst Eu2 06 • F12
Lc Rst Eu2 06 • F12 Phantom 94-98 • F12 Phantom
Eu1 99-00 • F12 Phantom Lc 94-98 • F12 Phantom
Lc Eu1 99-00 • F12 Phantom Lc Rst Eu1 01-02 • F12
Phantom Lc Rst Eu2 02 • F12 Phantom Lc Rst Eu2-
2.3 03-04 • F12 Phantom Lc Twin Disks 98 • F12
Phantom Rst Eu1 01-02 • F12 Phantom Rst Eu2 02
• F12 Phantom Rst Eu2-2.3 03-04 • F15 Fire Fox Air
Cooled 05-06
100: F12 Phantom 99-00
(R.O.09003100)



24 605 0110 

50: F15 Fire Fox 96-98 • F15 Fire Fox Eu2 02-
03 • F15 Fire Fox Rst Eu2-2.3 03-04 • F15 Fire
Fox Twin Disks & Special 98-99 • F15 Fire Fox
Twin Disks Digit Kat 98-00 • F15 Lc Rst Eu2
04-05 • F15 Lc-Tds Rst Eu1 01
125-150: F18 Warrior 00-02
(R.O.09003800)





QUADRETTI AVVIAMENTO
IGNITION SWITCHES KIT

MALAGUTI

24 605 0430 

50: Ciak 99-00 • Ciak Master 04 • Ciak Master 4T 05-06 • Ciak Master Eu2 06 • Ciak Mono Eu 2 03 • Ciak Mono Eu2 2.3 03 • Ciak Td 00-01
100: Ciak 99-00
125: Ciak 00-01 • Ciak Master 04 • Ciak Master Eu 3 06 • Ciak Rst Eu2 03
150: Ciak 00-02 • Ciak Master 04 • Ciak Rst Eu2 03
200: Ciak Master Eu 2 06
(kit 3 pezzi - *key set 3 pcs*)
(R.O.09005100)



24 605 0310 

50: Centro Base 93-94 • Centro SL 94-98 • Centro SL Kat 99-00 • F10 Ac 08 • F10 Ac Eco 09 • F10 Jet Line 92-98 • F10 Kat 99-00 • F10 Rst Eu1 01-02 • F10 Rst Eu2 06 • F10 Rst Eu2 02-03 • F10 Rst Eu2-2.3 03-04
(kit 3 pezzi - *key set 3 pcs*)
(R.O.09002600)



24 605 0320 

24 605 0321  
50: F12 Aria Rst Eu2 06 • F12 Lc Rst Eu2 06 • F12 Phantom 94-98 • F12 Phantom Eu1 99-00 • F12 Phantom Lc 94-98 • F12 Phantom Lc Eu1 99-00 • F12 Phantom Lc Rst Eu1 01-02 • F12 Phantom Lc Rst Eu2 02 • F12 Phantom Lc Rst Eu2-2.3 03-04 • F12 Phantom Lc Twin Disks 98 • F12 Phantom Rst Eu1 01-02 • F12 Phantom Rst Eu2 02 • F12 Phantom Rst Eu2-2.3 03-04
100: F12 Phantom 99-00
(kit 3 pezzi - *key set 3 pcs*)
(R.O.09002800)



24 605 0330 

50: F15 Fire Fox 96-98 • F15 Fire Fox Air Cooled 05-06 • F15 Fire Fox Eu2 02-03 • F15 Fire Fox Rst Eu2-2.3 03-04 • F15 Fire Fox Twin Disks & Special 98-99 • F15 Fire Fox Twin Disks Digit Kat 98-00 • F15 Lc Rst Eu2 04-05 • F15 Lc-Tds Rst Eu1 01
125: F18 Warrior 00-02
150: F18 Warrior 00-02
(kit 3 pezzi - *key set 3 pcs*)
(R.O.09003500)



24 605 0570 

50: Centro 4T 08 • Centro SL 4T 10
125: Centro ie 08-09 • Centro SL Le 09
160: Centro ie 08-09 • Centro SL Le 09
(R.O. 09008400)



MBK

24 605 0130 

50: Cw Rs Booster Ng 95-99 • Cw Rs Booster Ng 01-02 • Cw Rs Booster Ng Eu1 99-00 • Cw Rsp Booster Rocket [I] 97-98 • Cw Rsp Booster Track 96-98
(kit 2 pezzi - *key set 2 pcs*)
(R.O.45BH20210200)



24 605 0140 

24 605 0141 

50: Cw Booster 90-94 • Cw Booster 01-02 • Cw R Booster Road (Ita) 94-95 • Cw Booster Spirit 96-00 • Cw Booster Spirit Eu2 02 • Ew Stunt 00-02 • Ew Slider 00/02
(kit 2 pezzi - *key set 2 pcs*)
(R.O.3VLH250100 - 5JHH20210000)



24 605 0150 

50: Yn R Ovetto (Che-Ita) 97-01
(R.O.5ADH25010100)





MBK

24 605 0160 

24 605 0161 

50: Yq Nitro 97-02
(kit 2 pezzi - key set 2 pcs)
(R.O.5BR-H2021-0000)

24 605 0270 

24 605 0271 

50: Yn R Ovetto (Che-Ita) 97-01
(kit 2 pezzi - key set 2 pcs)
(R.O.5AD-H2501-00)

24 605 0280 

24 605 0282 

50: Yq Nitro 97-02
(kit 4 pezzi - key set 4 pcs)
(R.O.5BR-H2021-0100)



24 605 0290 

50: Yh Flipper 98 • Yh Flipper 01-02
• Yh Flipper Catalitico 99-00
(kit 3 pezzi - key set 3 pcs)
(R.O.5EU-H2021-00)

24 605 0360 

125: Yp Skyliner 98-00
150: Yp Skyliner 00
(kit 2 pezzi - key set 2 pcs)
(R.O. 5DSS25010100)

24 605 0460 

50: Cs Mach G Eu1 02-03 • Cs Mach G Eu2 02-04
• Yn R Ovetto Eu1 02-04 • Yn R Ovetto Eu2 02-03
100: Yn Ovetto 00-02
(R.O. 5KKH25010000)



24 605 0580 

50: CW Booster 04
(R.O. 5WWH25010000)

24 605 0590 

50: Yq L Nitro Jaguar 04 • Yq Nitro Eu 2 03
• Yq Nitro 04
(R.O. 5WJH20211000)

24 605 0591 

50: Yq L Nitro Jaguar 04 • Yq Nitro Eu 2 03
• Yq Nitro 04
(kit 4 pezzi - key set 4 pcs)
(R.O. 5WJH20211000)





QUADRETTI AVVIAMENTO
IGNITION SWITCHES KIT

PEUGEOT

24 605 0170 

24 605 0171 

50: Buxy 94-97 • Fox 94-98 • Speedake 95-97 • Zenith L 94-96 • Zenith Ln-Ls 97-98 • Zenith N 97-98
(kit 2 pezzi - *key set 2 pcs*)
(R.O.752727)



24 605 0180 

50: Speedfight Acqua 97-98 • Speedfight Aria 97-98
100: Trekker 98
(kit 2 pezzi - *key set 2 pcs*)
(R.O.752849)



24 605 0500 

50: Ludix 10 One 04 • Ludix 14 Classic 04 • Metal-X 02 • Speedfight 2 Aria 05-06 • Trk2 Wrc 04-06 • Xrace 03
R.O. 755930)



24 605 0510 

24 605 0511 

50: Speedfight li Serie Ac-Lc
(Senza immobilizer - *Without immobilizer*)





PIAGGIO

24 605 0680



1 Pz - 1 Pcs



24 605 0700



3 Pz - 3 Pcs



COMMUTATORE ACCENSIONE - MAIN SWITCH

PIAGGIO: Liberty Elettrico Ppt Aut 11 • **50:** Fly 2T 05-11 • Fly 4T & 25-30 Km/h 08-11 • Fly 4T Motore Chn 06-07 • Fly 4T 05-07 • Liberty 2T Rst 04 • Liberty 2T Sport 06-08 • Liberty 2T 06-08 • Liberty 4T Delivery Single 10-14 • Liberty 4T Delivery Tnt 09 • Liberty 4T Ptt Deu 07-12 • Liberty 4T Ptt Double 09-12 • Liberty 4T Rst 04 • Liberty 4T Sport 06-08 • Liberty 4T 00-08 • Liberty Moc 2T-4T & Elle 09-13 • Liberty Ptt Eu2 04-05 • Liberty 97-05 • Nrg Power Dd Serie Speciale 07-12 • Nrg Power Dd 05-13 • Nrg Power Dt Serie Speciale 07-08 • Nrg Power Dt 06-11 • Nrg Powerjet 04-11 • Nrg Purejet 10 • Typhoon 2T Eu2 10-12 • Typhoon 2T Eu3 Ch 11 • Vespa Et2 97-05 • Vespa Et4 00-05 • Vespa Lx 2T Touring & 30 Km/h 10-13 • Vespa Lx 2T 05-13 • Vespa Lx 4T-4V Touring 10-13 • Vespa Lx 4T-4V 09-13 • Vespa Lx 4T 05-08 • Vespa Lxv 2T Navy 08 • Vespa Lxv 2T 06-09 • Vespa primavera 2T 13-15 • Vespa Primavera 4T-4V 13-14 • Vespa S 2T & College 07-12 • Vespa S 4T-4V & College 08-12 • Vespa Sprint 2T 2V 14-15 • Vespa Sprint 4T 4V 14 • Zip 2T 08-13 • Zip 4T 00-13 • Zip Sp Eu2 06-13 • Zip Sp 01-04 • Zip 00-04 • **100:** Fly 4T 06-10 • **125:** Fly Eu3 • Fly Eu3 07-11 • Fly 05-07 • Hexagon Gtx 00 • Hexagon Lx4 98-99 • Liberty 4T 2V Eu3 09-12 • Liberty 4T 2V ie Ptt Ita 12 • Liberty 4T Eu3 Delivery Single 07-15 • Liberty 4T Eu3 Delivery Tnt 08-09 • Liberty 4T Eu3 06-08 • Liberty 4T Sport Eu3 06-08 • Liberty 4T 06-07 • Liberty Rst Ptt 05-11 • Liberty Rst 04-05 • Liberty Sport 06 • Liberty 01-02 • Skipper 4T 00-02 • Super Hexagon Gtx 12 01-02 • Typhoon 4T 2V Eu3 10-11 • Vespa 946 4T 3V Abs 13-14 • Vespa Et4 99-02 • Vespa Lx 4T 3V ie Touring 12-13 • Vespa Lx 4T Eu3 Touring 10-11 • Vespa Lx 4T FL 09 • Vespa Lx Eu3 ie 09-11 • Vespa Lx Eu3 06-08 • Vespa Lx 05-06 • Vespa Lxv 4T Eu3 06-09 • Vespa Lxv 4T Navy Eu3 07-08 • Vespa Lxv ie 4T 10-13 • Vespa S 4T 3V ie 12 • Vespa S 4T Eu3 07-08 • Vespa S 4T ie & College 09-11 • X7 Eu3 08 • X9 01-02 • Zip 00-02 • **150:** Fly Eu3 08-11 • Fly 05-07 • Liberty 4T Eu3 08 • Liberty 4T Sport Eu3 08 • Liberty Moc 4T Eu3 09-13 • Vespa Lx 4T 3V ie Touring 12-13 • Vespa Lx 4T FL 09 • Vespa Lx Eu3 ie 09-11 • Vespa Lx Eu3 06-08 • Vespa Lx Touring 10-12 • Vespa Lx 05-06 • Vespa S 4T ie & College 09-12 • Vespa S 4T 08-09 • **180:** X9 Amalfi 00-03 • **200:** Liberty 4T Eu3 06-08 • Liberty 4T Sport Eu3 06-07 • Liberty Rst 04 • Liberty Sport 06 • Liberty 06 • X9 02-03 • **250:** Hexagon Gt - Gtx 98-00 • X7 Eu3 08 • X9 00-01 • **500:** X9 01-02 (R.O. 643133)

24 605 0710



PIAGGIO 50: Nrg Extreme 99-00 • Nrg Mc3 01-04 • Nrg Purejet 02-04 • Typhoon 01-11 • Zip Rst 96-99 (R.O.580639)



24 605 0230



PIAGGIO: Vespa Et3-Vespa Px-Vespa Pe (R.O.160743)



24 605 0660



COMMUTATORE A CHIAVE - KEY SWITCH
PIAGGIO 50: Vespa Et2 Iniezione 97-00
125: Vespa Et4 96-98 (R.O. 298687)



24 605 0670



COMMUTATORE A CHIAVE - KEY SWITCH
PIAGGIO 50: Ape 09 • Rst Mix 99-03 • Mix 2T 98-08 • FL3 Europa 96-99 • FL/FL2 89-95 (R.O. 291582)



24 605 0693



COMMUTATORE A CHIAVE - KEY SWITCH
PIAGGIO: Vespa Px 125-150-200 Vnx-Vlx-Vsx • Vespa Pk 50-125 (R.O. 178593)





QUADRETTI AVVIAMENTO
IGNITION SWITCHES KIT

YAMAHA

24 605 0130 

50: Bw'S Bump 97-98 • Bw'S Next Generation 97-02 • Bw'S Next Generation Cat. 99-00 • Cw Rs Spy 95-98 • (kit 2 pezzi - *key set 2 pcs*) (R.O.4SBH20210200)



24 605 0140 

24 605 0141 

50: Bw'S Original 97-02 • Bw'S Original Eu2 02 • Bw'S R 01 • Ew Slider 00-02 • Ew Slider 00/02 (kit 2 pezzi - *key set 2 pcs*) (R.O.3VLH250100-5JHH20210000)



24 605 0150 

50: Yn Neo'S 97-01 (R.O.5ADH25010100)



24 605 0160 

24 605 0161 

50: Yq Aerox 97-98 • Yq Aerox 01-02 • Yq Aerox R 99-00 (kit 2 pezzi - *key set 2 pcs*) (R.O.5BR-H2021-0000)



24 605 0270 

24 605 0271 

50: Yn Neo'S 97-01 (kit 2 pezzi - *key set 2 pcs*) (R.O.5AD-H2501-00)



24 605 0280 

24 605 0282 

50: Yq Aerox 97-98 • Yq Aerox 01-02 • Yq Aerox R 99-00 (kit 4 pezzi - *key set 4 pcs*) (R.O.5BR-H2021-0100)



24 605 0290 

50: Yh Why 98 • Yh Why 01-02 • Yh Why Eu1 99-00 (kit 3 pezzi - *key set 3 pcs*) (R.O.5EU-H2021-00)



24 605 0360 

125: Yp E Majesty 98-00
150: Yp Majesty 00 (kit 2 pezzi - *key set 2 pcs*) (R.O. 5DSS25010100)



24 605 0460 

50: Cs Jog R 02 • Cs Jog R 06-10 • Cs Jog R Eu2 02-05 • Yn Neo'S 02 • Yn Neo'S 04-06 • Yn Neo'S Eu2 02-03
100: Yn Neo'S 99-02 (R.O. 5KKH25010000)



24 605 0580 

50: Bw'S 04-11 • Bw'S Naked 04-11 • Cw L Bw'S 04 (R.O. 5WWH25010000)



24 605 0590 

50: Yq Aerox 04-12 • Yq L Aerox Eu2 03 (R.O. 5WJH20211000)



24 605 0591 

50: Yq L Nitro Jaguar 04 • Yq Nitro Eu 2 03 • Yq Nitro 04 (R.O. 5WJH20211000)





12 179 0280 

APRILIA 50: Sport City One 2T 08-11 • Sport City One 4T 08-10 • Sr Motard 12-13
125: Sport City One 4T Eu3 08-11 • Sr Motard 12-13
PIAGGIO 50: Typhoon 2T Eu2 10-12 • Typhoon 2T Eu3 Ch 11 • **125:** Typhoon 4T 2V Eu3 10-11 (R.O. 860193)



12 179 0272 

PIAGGIO 125: Vespa Et3 VMB1
Kit serratura 4 mm chiavi in metallo
Kit cylinder 4 mm metal key
(R.O. 139188)



12 179 0141 

PIAGGIO 125: Vespa Et3 Primavera • Super • Px
150: Vespa Px - **200:** Vespa Px • Rally

12 179 0142 

SERRATURA BAULETTO - TOOL BOX LOCK
PIAGGIO 125: Vespa Primavera Et3
(R.O. 139379)



12 179 0160 

GILERA 50: Runner 97-00 • Runner Poggiali 02
Runner FL 02 • Runner Purejet 02 • Ice 01
125-180: Runner Fx • Fxr 97-02
125-200: Runner Vx • Vxr 02
(2 cilindretti - *Cylinder locks 2 pcs*)
(R.O. 576718)



12 179 0040 

12 179 0042 

GILERA 50: Easy Moving 95-96 • Storm 94-95
Typhoon 94-97 • X-Xr 98-00
125: Typhoon 95-98 • X-Xr 99-00

PIAGGIO 50: Free 92-94 • Nrg 94-96 • Ntt 95-96 • Quartz 92-96 • Sfera 91-93 • Maquillage 2 94 • Rst 95-97 • Typhoon 01-04 • Vespa Pk XL Plurimatic 85-90 • Pk XL 85-88 • Pk XL Rush 88-89 • N 89-90 • Pk 50-125 82-84 • Zip 92-96 • Fast Rider 93-94

80: Skr City

125: Sfera 95-97 • Vespa Pk XL 86-89 • Px T5 85-89 • Px Eu2 01-06

125-150-200: Cosa CL • CLX • Pxe Arcobaleno 81-97 • Px 98-01

125-150: Skipper 94-97

(Kit 2 pezzi cilindretti - *Cylinder lock 2 pcs*)
(R.O. 179292)



12 179 0212 

PIAGGIO 50: Ape 50
(R.O. 258664)



12 179 0010 

PIAGGIO: Vespa Et2 • Et4 • Liberty
Serratura: 2 chiavi - 1 cilindretto
Cylinder lock 1 pcs. - 2 keys
(R.O. 573905)



12 179 0040 

(Kit 2 pezzi cilindretti - *Cylinder lock 2 pcs*)
(R.O. 179292)

12 179 0232 

PIAGGIO 50-125: Vespa Pk 50 XL
Kit 5 pezzi cilindretti - *set of 5 pcs.*
(R.O. 196467)



12 179 0020 

PIAGGIO: Vespa Et2 • Et4 • Liberty
Serratura: 2 chiavi - 2 cilindretti
Cylinder lock 2 pcs. - 2 keys



12 179 0060 

12 179 0062 

PIAGGIO: Vespa Px / Pe
Arcobaleno / Pk 50 XL
Kit 3 pezzi cilindretti:
sterzo-bauletto-sella
Cylinder lock set - set of 3 pcs.
steering - case - seat



12 179 0090 

12 179 0092 

PIAGGIO: Vespa 125 Px / Arcobaleno
Pk / Pk XL / Rush / N / FL
cilindretto per serratura sterzo
sella / bauletto
cylinder lock - 1 pc.
For steering - case - seat
(R.O.196486)





CILINDRETTI SERRATURA CYLINDER LOCKS

12 179 0032



PIAGGIO 50: Zip • Zip Rst 93-00
(Kit 3 pezzi cilindretti - *Cylinder lock 3 pcs*)
(R.O. 295652)



12 179 0122



PIAGGIO 50-90-125: Primavera • Ape 50
Chiave in plastica - *Plastic 2 keys*
Guida mm 4 - *Size mm 4*
(R.O. 152096)



12 179 0132



PIAGGIO 125-150-200: Vespa Px
Chiave in plastica - *Plastic 2 keys*
Guida mm 6 - *Size mm 6*
(R.O. 139371)



12 179 0202



LUCCHETTO STERZO - STEERING LOCK
Chiave in metallo - *Metal 2 keys*
Guida mm 6 - *Size mm 6*
PIAGGIO 125-150-200: Vespa Px • Pe



12 179 0192



LUCCHETTO STERZO - STEERING LOCK
Chiave in metallo - *Metal 2 keys*
Guida mm 4 - *Size mm 4*
PIAGGIO 50-125: Vespa 50 • Primavera - Et3
(R.O. 152096)



12 179 0222



LUCCHETTO STERZO - STEERING LOCK
Chiave in metallo - *Metal 2 keys*
Guida mm 4 - *Size mm 4*
PIAGGIO 50-125: Vespa 50 • Primavera - Et3
(R.O. 120328)



12 179 0293



SERRATURA STERZO - CYLINDER LOCK
PIAGGIO 125-150: Vespa
(R.O. 082416)



12 179 0303



SERRATURA STERZO - CYLINDER LOCK
PIAGGIO: Vespa >58



12 179 0313



SERRATURA SELLA - CYLINDER LOCK
PIAGGIO 125-150-200: Vespa Px 1 Serie
Vnx-Vlx-Vsx
(R.O. 190013)



12 179 0262



KIT SERRATURE(GUIDA 4 MM)
LOCKS KIT 3 PCS SIZE 4 MM
Vespa Px 125-150- P200e
(R.O. 184860)



12 179 0152



SERRATURA SPORTELLINO LATERALE
SIDE DOOR LOCK
PIAGGIO 50-90-125: Vespa Primavera



12 179 0172



KIT SERRATURE PIAGGIO - TOOL BOX LOCK
PIAGGIO 125-150-200: Vespa Px 2 serie
Chiave in metallo - *Metal key*
Guida 6 mm - *Size 6 mm*
(R.O. 182178)





12 179 0162



KIT SERRATURE - TOOL BOX LOCK

PIAGGIO 125-150-200: Vespa Px 1 serie

125-150: GL Sprint Super

Chiave in plastica

Plastic key

Guida 4 mm

Size 4 mm

(R.O.: 139188)



12 179 0180



SERRATURA BAULETTO - TOOL BOX LOCK

PIAGGIO VESPA: 50 N 89-90 • Pk XL Rush 88-90

Pk XL 85-88 • Px 125-150-200 98-01

Px T5 125 85-89 • Pxe Arcobaleno 125-150-200

81-97

(R.O. 198560)



12 179 0252



SERRATURA BAULETTO - TOOL BOX LOCK

PIAGGIO 125-150: Vespa Px Millenium

(R.O. 576998)



12 179 0170



SERRATURA SELLA PIAGGIO - SADDLE LOCK

VESPA: Pk 125-150-200 98-01 • Px 30 Anni 125

07-08 • Px Eu 2 125 01-07 • Px T5 125 85-89

Pxe Arcobaleno 125-150 81-97

(R.O. 178887)



12 179 0182



KIT COPERCHIETTO SERRATURA

LOCK COVER

PIAGGIO 50-90-125: Vespa Primavera

150: Vespa GL • Sprint - Rally

(R.O. 152097-8-9)



12 179 0413



SERRATURA SELLA - SADDLE LOCK

LOCK COVER

PIAGGIO: Vespa Millenium

(R.O. 577267)



12 179 0190



COPERCHIETTO SERRATURA

LOCK COVER

PIAGGIO Vespa Px 1° serie - Ape 50

(RO: 174628)



12 179 0242



SBOZZATO CHIAVE - KEY BLANK

PIAGGIO: Vespa • Ape

(R.O. 120330)



12 195 0090



MOLLA SERRATURA BAULETTO

TOOLBOX LOCK SPRING

PIAGGIO: Vespa 125 Primavera-Sprint-Rally-Px

(R.O. 073260)



12 187 0080



CORPO CILINDRETTO SERRATURA

CYLINDER LOCK KNOB

APRILIA: Sport City 50 08 • Sport City 125 08

GILERA: Ice 50 01 • Runner 50 • FL • Poggiali

Purejet 97-04 • Runner 125-150-200 • Fx • Fxr-
Vx • Vxr-97-02

PIAGGIO: Beverly 125-200-250-500 01-04

Rst 125 04 • Fly 50 2-4 T-150 05 • Hexagon Lx4

125 98-99 • Lx-Lxt 125-180 98-99 • Super Gtx 12"

125-180 01-02 • Hexagon Gt-S. Hexagon Gtx

250 98-00 • Super Hexagon Gtx 125-180 00 •

Liberty 50 2-4 T 97-02 • Rst 50 2/4 T 125 04

Rst 125-150-200 98-05 • Skipper 4T 125-150

00-02 • Lx 125-150 98-99 • Vespa 50 Et2

Iniezione 97-0 • Et4 50 00-02 • Et4 125-125-150

96-02 • Vespa Gran Turismo 125-200 03 •

X8 125-200 04 • X9 125-200-250-500 01-03 •

X9 Evolution 125-200-250-500 03 > X9 Amalfi

180 00-03 • Zip Sp 50 01-04 • Zip 50 Euro 1 00-

02 • Zip 4T 50 00-04

(R.O. 298581)



12 187 0012



CORPO CILINDRETTO SERRATURA

CYLINDER LOCK KNOB

PIAGGIO - GILERA

(R.O. 297777)



12 187 0022



CORPO CILINDRETTO SERRATURA

CYLINDER LOCK KNOB (R.O. 298581)

PIAGGIO 50: Vespa Pk • FL • Sfera • Free

125-150: Skipper

125-150-200: Cosa 2

(R.O. 254536)





IMPIANTI ELETTRICI CABLE HARNESS

IMPIANTI ELETTRICI VESPA - VESPA CABLE HARNESS



CODICE RMS RMS CODE	DESCRIZIONE DESCRIPTION	CODICE ORIGINALE ORIGINAL CODE	BARCODE
24 649 0041	Impianto Elettrico Vespa 125 Modello 1955 <i>Vespa Cable Harness 125 Model 1955</i>	022681	
24 649 0051	Impianto Elettrico Vespa 125 <i>Vespa Cable Harness 125</i>	091462	
24 649 0061	Impianto Elettrico Vespa 50 <i>Vespa Cable Harness 50</i>	102462	
24 649 0071	Impianto Elettrico Vespa 180 Rally-Gtr 125-Sprint Vel.150 <i>Vespa Cable Harness 180 Rally-Gtr 125-Sprint Vel.150</i>	114309	
24 649 0081	Impianto Elettrico Vespa 50 Special <i>Vespa Cable Harness 50 Special</i>	142965	
24 649 0091	Impianto Elettrico Vespa 90-125 Primavera <i>Vespa Cable Harness 90-125 Primavera</i>	144505	
24 649 0101	Impianto Elettrico Vespa 125 ET3 <i>Vespa Cable Harness 125 ET3</i>	149247	
24 649 0111	Impianto Elettrico Vespa Px 2 Serie - (Con frecce) <i>Vespa Cable Harness Px 2nd Series - (With flashers)</i>	243566	
24 649 0120	Impianto Elettrico Vespa GL 150 <i>Vespa Cable Harness GL 150</i>	090388	
24 649 0121	Impianto Elettrico Vespa GL 150 <i>Vespa Cable Harness GL 150</i>	090388	
24 649 0140	Impianto Elettrico Vespa Pk 50 S V5X2T <i>Vespa Cable Harness Pk 50 S V5X2T</i>	243203	
24 649 0150	Impianto Elettrico Vespa Px 125-150-200 - (Senza avviamento elettrico) <i>Vespa Cable Harness Px 125-150-200 - (No electric starter)</i>	217897	
24 649 0160	Impianto Elettrico Vespa Px 125-150-200 - (Con avviamento elettrico) <i>Vespa Cable Harness Px 125-150-200 - (With electric starter)</i>	242182	
24 649 0171	Impianto Elettrico Vespa 125 V30T-V33T-VM1T-VU1T <i>Vespa Cable Harness 125 V30T-V33T-VM1T-VU1T</i>	018201	
24 649 0181	Impianto Elettrico Vespa 150 VBB1 <i>Vespa Cable Harness 150 VBB1</i>	057126	
24 649 0191	Impianto Elettrico Vespa Gs 160 VSB1 <i>Vespa Cable Harness Gs 160 VSB1</i>	070124	
24 649 0211	Impianto Elettrico Vespa 150 VLA1T <i>Vespa Cable Harness 150 VLA1T</i>	070651	
24 649 0221	Impianto Elettrico Vespa 150 VL2/3-VB1 <i>Vespa Cable Harness 150 VL2/3-VB1</i>	81300	
24 649 0231	Impianto Elettrico Vespa 125 VNA1/2T <i>Vespa Cable Harness 125 VNA1/2T</i>	081021	
24 649 0241	Impianto Elettrico Vespa 150 VBA1 <i>Vespa Cable Harness 150 VBA1</i>	084354001	
24 649 0251	Impianto Elettrico Vespa 160 VSB1 <i>Vespa Cable Harness 160 VSB1</i>	093736	
24 649 0261	Impianto Elettrico Vespa 125 VNB2/3/4 <i>Vespa Cable Harness 125 VNB2/3/4</i>	093489	
24 649 0271	Impianto Elettrico Vespa Px 125-150-200 I° serie - (Senza frecce) <i>Vespa Cable Harness Px 125-150-200 I° series - (Without blinkers)</i>	162064	
24 649 0291	Impianto Elettrico Vespa 150 Ss 180 VBB2-VSC1 <i>Vespa Cable Harness 150 Ss 180 VBB2-VSC1</i>	098253	
24 649 0301	Impianto Elettrico Vespa Ss 180 VSC1 <i>Vespa Cable Harness Ss 180 VSC1</i>	098235001	



24 633 0180 

PORTA CONNETTORI ELETTRICI "SUPERSEAL"
ELECTRICAL HOLD CONNECTORS "SUPERSEAL"

- 2 Vie 3 pezzi - 2 Pins 3 pcs
- 3 Vie 3 pezzi - 3 Pins 3 pcs
- 4 Vie 3 pezzi - 4 Pins 3 pcs
- Connettori e gommini inclusi - *Connectors and seals included*



24 633 0190 

PORTA CONNETTORI ELETTRICI "MINITIMER"
ELECTRICAL HOLD CONNECTORS "MINITIMER"

- 3 pezzi - 3 pcs
- Connettori e gommini inclusi - *Connectors and seals included*



24 633 0200 

PORTA CONNETTORI ELETTRICI "090"
ELECTRICAL HOLD CONNECTORS "090"

- 2 Vie 1 pezzo - 2 Pins 1 pcs
- 3 Vie 1 pezzo - 3 Pins 1 pcs
- 4 Vie 1 pezzo - 4 Pins 1 pcs
- 6 Vie 1 pezzo - 6 Pins 1 pcs
- Connettori e gommini inclusi - *Connectors and seals included*



24 633 0210 

PORTA CONNETTORI ELETTRICI "BOSCH"
ELECTRICAL HOLD CONNECTORS "BOSCH"

- 3 Pezzi - 3 pcs
- Connettori e gommini inclusi - *Connectors and seals included*



24 633 0220 

PORTA CONNETTORI ELETTRICI 6,3 mm
ELECTRICAL HOLD CONNECTORS 6,3 mm

- 2 Vie 3 pezzi - 2 Pins 3 pcs
- 3 Vie 3 pezzi - 3 Pins 3 pcs
- 4 Vie 3 pezzi - 4 Pins 3 pcs
- 6 Vie 3 pezzi - 6 Pins 3 pcs
- 9 Vie 3 pezzi - 9 Pins 3 pcs
- Connettori inclusi - *Connectors included*



24 633 0230 

PORTA CONNETTORI ELETTRICI 110 ml
ELECTRICAL HOLD CONNECTORS 110 ml

- 2 Vie 3 pezzi - 2 Pins 3 pcs
- 3 Vie 3 pezzi - 3 Pins 3 pcs
- 4 Vie 3 pezzi - 4 Pins 3 pcs
- 6 Vie 3 pezzi - 6 Pins 3 pcs
- 9 Vie 3 pezzi - 9 Pins 3 pcs
- Connettori inclusi - *Connectors included*





IMPIANTI ELETTRICI

CABLE HARNESS

24 633 0240



FASTOM FEMMINA 6,3 mm
CONFEZIONE 100 PEZZI
FEMALE FASTOM 6,3 mm 100 PCS PACK



24 633 0250



COPRI FASTOM MASCHIO 6,3 mm
CONFEZIONE 100 PEZZI
MALE FASTOM COVER 6,3 mm 100 PCS PACK



24 633 0260



COPRI FASTOM FEMMINA 6,3 mm
CONFEZIONE 100 PEZZI
FEMALE FASTOM COVER 6,3 mm 100 PCS PACK



24 633 0270



FASTOM MASCHIO 6,3 mm CONFEZIONE 100 PEZZI
MALE FASTOM 6,3 mm 100 PCS PACK



24 633 0280



OCCHIELLI 6,3 mm CONFEZIONE 100 PEZZI
ROUND CONNECTOR 6,3 mm 100 PCS PACK



24 633 0290



FASTOM CILINDRICI MASCHIO CONFEZIONE 100 PEZZI
CYLINDRICAL FASTOM MALE 100 PCS PACK



24 633 0310



CONFEZIONE 35 CONNETTORI PREISOLATI
(7 tipi)
PACK OF 35 PLASTIC COATED CONNECTORS
(7 types)



24 633 0320



CONFEZIONE 75 OCCHIELLI Ø 6 mm
M6 1,5-6-10 mm² - (25 pezzi x tipo)
PACK OF 75 Ø 6 mm ROUND CONNECTORS
M6 1,5-6-10 mm² - (25 pcs x types)



24 633 0330



CONFEZIONE 5 GUAINE TERMORETRAIBILI
VARIE MISURE
PACK OF 5 HEAT SHRINKABLE TUBE IN
DIFFERENT MEASURES





24 649 0020 

PRESA BASSA TENSIONE - L.T. SOCKET ASSY
PIAGGIO: Vespa 50-90 Primavera
(R.O. 070744)



24 649 0030 

PRESA BASSA TENSIONE - L.T. SOCKET ASSY
PIAGGIO: Vespa 125 • Gt-Rally
(R.O. 120811)



24 649 0133 

PRESA DI CORRENTE - L.T. SOCKET ASSY
Vespa Px 125-150-T5
VNX2-VLX2-VSX2-VNX5T
(R.O. 178895)



24 649 0280 

PRESA BASSA TENSIONE
L.T. SOCKET ASSY
Vespa Et3 VMB1
(R.O. 185458)



24 649 0310 

PRESA DI CORRENTE - L.T. SOCKET ASSY
PIAGGIO 125: Vespa Gtr
150: Sprint Veloce • Super
200: Rally
(R.O. 149082)



24 649 0330 

PRESA DI CORRENTE - L.T. SOCKET ASSY
Vespa Pxe 125-150-200
VNX-VLX-VSX
(R.O. 163476)



24 649 0320 

PRESA DI CORRENTE - L.T. SOCKET ASSY
Vespa PX 125-50-200
VNX-VLX-VSX
Modello con frecce - *Blinkers Model*
(R.O. 163603)



24 649 0200 

GUAINA CABLAGGIO - ELECTRIC SHEATH
PIAGGIO: Vespa
Vari Modelli Vespa - *Varios Vespa Models*
(R.O. 610076M)



12 183 0560 

CAPPUCCIO BOBINA - COIL CAP
PIAGGIO 50-125: Vespa Pk • Rush • N
(R.O. 231751)



12 183 0570 

CAPPUCCIO CENTRALINA - CDI UNIT CAP
PIAGGIO 50-125: Vespa Pk • Rush • N
(R.O. 255526)



12 183 0580 

CAPPUCCIO CENTRALINA - CDI UNIT CAP
PIAGGIO 125-150-200: Vespa Px • Cosa 1-2
(R.O. 198686)





CONDENSATORI CONDENSERS

24 619 0010



PIAGGIO 50-125: Vespa
(R.O. 078937)



24 619 0020



PIAGGIO 50: Vespa • Ape • P
125: Vespa P
(R.O. 079697)



24 619 0030



PIAGGIO 125-150: Vespa Px
(R.O. 182343)



24 619 0040



PIAGGIO 550: Ape Mvp
600: Ape Mp • Ape Mpv
(R.O. 123828)



24 619 0050



PIAGGIO 50: Si • Bravo • Ciao • Boxer • Grillo
(R.O. 102939)



24 619 0060



PIAGGIO 125: Vespa Gtr
150: Sprint GL • Super
180: Rally
(2 Fili - 2 wires)
(R.O. 155973)



24 619 0070



PIAGGIO: Vespino Spagna



24 619 0080



PIAGGIO 125: Vespa
150: Vespa Gs
(R.O. 018941)



24 619 0090



PIAGGIO 125-150: Vespa Super
(R.O. 133052)



24 619 0110



INNOCENTI 125-150-200: Lambretta Li



24 619 0120



INNOCENTI 125-150-200: Lambretta DL





24 615 0010 



PIAGGIO 50: Ciao • Bravo • Boxer • Si Ape • Cba
(R.O. 103133)



24 615 0020 



PIAGGIO 50: Vespa • Special • L • R • N
(R.O. 101761)



24 615 0030 



PIAGGIO 50: Ape • Ape P 71 >
90-125: Vespa Primavera • Ape
180: Rally 72 >
(R.O. 141838)



24 615 0040 



PIAGGIO 550: Ape Mp
600: Ape Mpv • Ape Mp
(R.O. 118540)



24 615 0050 



PIAGGIO 150: Vespa Sprint • Gtr • Super
400-500: Ape 71 >
(R.O. 129434)



24 615 0060 



PIAGGIO 150: Vespa Px 1° serie
(Impianto Bobina - *Models with coil*)
Vespa Sprint • Super 74 >
400: Ape P
(R.O. 140963)



24 615 0070 



PIAGGIO 125-150: Vespa Px Modello con frecce
Models with flashers
(R.O. 134117/182342)



24 615 0080 



PIAGGIO 125: Vespa Vnb4t-Vnb5t-Vns4t-
Vespa Gt VNL1T
150: Vespa GL VLA1T
(R.O. 97478)



24 615 0100 



PIAGGIO: Vespino Spagna



24 615 0090 



PIAGGIO 180: Vespa Rally-Super Sport
200: Rally VSC1T-VSD1T-VSE1T
(R.O. 111300)



24 615 0120 



PIAGGIO 98-125: Vespa
(R.O. 610075M)



24 615 0130 



PIAGGIO 150: Vespa Gs
(R.O. 097477)



24 615 0140 



INNOCENTI 125-150-200: Lambretta Li - DL





RMS

YOUR BEST PARTNER

▶ LINEA WORKSHOP

WORKSHOP LINE



PETRONAS





NUOVA LINEA PRODOTTI MOTO
NEW MOTORCYCLE PRODUCT LINE



26 720 0730



GRASSO CATENE - CHAIN GREASE SPRAY
Conf. 75 ML



26 720 0740



LUBRIFICANTE CATENE - CHAIN LUBRICANT
Conf. 300 ML



26 720 0750



PULITORE CATENE - CHAIN CLEANER
Conf. 400 ML



26 720 0760



GOMMA SPRAY - INFLATE AND REPAIR
Conf. 200 ML



26 720 0770



CROMATURE BRILLANTI - CHROME CARE
Conf. 150 ML



26 720 0780



DETERGENTE MOTO - BIKE DEGREASER
Conf. 400 ML



26 720 0790



RAIN OFF VISIERE - VISORS RAIN OFF



26 720 0800



IGIENIZZANTE CASCO - HELMET SANITIZING





NUOVA LINEA OLIO "LINX"
NEW "LINX" OIL LINE

26 725 0150



OLIO MOTORE SUPERPLUS 2T

Litri - *Liter* 1



Specifiche API TC, JASO FB (Low smoke)
ISO GLOBAL L-EGD

26 725 0160



OLIO MOTORE SCOOTER MIX 2T SYNTHETIC

Litri - *Liter* 1



Specifiche API TC, JASO FC (Low smoke)
ISO GLOBAL L-EGD

26 725 0170



OLIO MOTORE TOP RACING 2T FULLY SYNTHETIC

Litri - *Liter* 1



Specifiche APITC+, JASO FC (Low smoke)
ISO GLOBAL L-EGD

26 725 0180



OLIO MOTORE SUPER SYNTHETIC 4T

Litri - *Liter* 1



Specifiche API SH, JASO MA-MA2
15W50

26 725 0190



OLIO MOTORE SCOOTER ONE 4T SYNTHETIC

Litri - *Liter* 1



Specifiche API SL, JASO MA-MA2
10W40



GUANTI IN NITRILE (Conf. 100 Pz.)

- Monouso senza polvere ambidestri
 - Protezione delle mani per usi di breve durata
 - Eccellente sensibilità
 - Si indossano e si tolgono facilmente
 - Esenti da rischi di allergia al lattice
- Rispettano le norme: ASTM-D3578-77(91), EN 455 1 e 2

NITRILE GLOVES (Packaging 100 pcs)

- Single-use with-out powder, ambidextrous
- Protective gloves for short-term use
- Excellent sensitivity
- You put on and take off easily
- No risk of latex allergy

According to: ASTM-D3578-77(91), EN 455 1 and 2



26 720 0230



Taglia - Size "M" - 100 Guanti

26 720 0240



Taglia - Size "L" - 100 Guanti

26 720 0250



Taglia - Size "XL" - 100 Guanti

GUANTI IN NITRILE SPESSTO (Conf. 50 Pz.)

- Per uso professionale Classe 8.0 MIL
- Monouso ed ambidestri
- Esenti da rischi di allergia al lattice
- Rispettano le norme: EN388-EN455 1 e 2-ASTM D3578

NITRILE THICK GLOVES (Packaging 50 pcs)

- For professional use Class 8.0 MIL
- Single-use and ambidextrous.
- No risk of latex allergy

According to: EN388-EN455 1 and 2-ASTM D3578



26 720 0260



Taglia - Size "M" - 50 Guanti

26 720 0270



Taglia - Size "L" - 50 Guanti

26 720 0280



Taglia - Size "XL" - 50 Guanti

26 720 0160



VERNICE SPRAY NERO OPACO PER MARMITTE

(Conf. 400 ml)

Smalto Spray per Alta Temperatura Nero opaco
Può essere utilizzato su superfici di metallo sottoposte ad alte temperature quali: parti del motore, impianti di scarico, stufe ecc.

Resiste fino a 600° C.

EXHAUSTS MATT BLACK SPRAY PAINT

High Temperature Spray Spray Matt Black. Can be used on metal surfaces subjected to high temperatures such as parts of engine, exhaust systems, heaters and so on. Resists up to 600 °



26 720 0162



VERNICE SPRAY TRASPARENTE PER MARMITTE

(Conf. 400 ml)

Smalto Spray per Alta Temperatura trasparente
Può essere utilizzato su superfici di metallo sottoposte ad alte temperature quali: parti del motore, impianti di scarico, stufe ecc.

Resiste fino a 600° C.

EXHAUSTS TRANSPARENT SPRAY PAINT

High Temperature Spray transparent. Can be used on metal surfaces subjected to high temperatures such as parts of engine, exhaust systems, heaters and so on. Resists up to 600 °



26 720 0620

SVITOL LUBRIFICANTE (400 ml)

L'esclusiva multifunzionalità lo rende l'alleato sicuro e indispensabile nelle mille occasioni d'uso quotidiano: dalla casa al giardino, dallo sport alla nautica, dal lavoro al fai da te.

Lubrifica
Sblocca
Protegge dalla corrosione
Elimina l'umidità

SVITOL LUBRICANT SPRAY (400 ml)

Exclusively and multifunctional. your safe, essentially for hundreds of everyday uses: home, garden, sport, boats, work and diy.

Lubricates
Unlocks
Corrosion protection
Removes humidity



26 720 0630

SVITOL LUBRIFICANTE (200 ml)

L'esclusiva multifunzionalità lo rende l'alleato sicuro e indispensabile nelle mille occasioni d'uso quotidiano: dalla casa al giardino, dallo sport alla nautica, dal lavoro al fai da te.

Lubrifica
Sblocca
Protegge dalla corrosione
Elimina l'umidità

SVITOL LUBRICANT SPRAY (200 ml)

Exclusively and multifunctional. your safe, essentially for hundreds of everyday uses: home, garden, sport, boats, work and diy.

Lubricates
Unlocks
Corrosion protection
Removes humidity



26 720 0460

SVITOL PROFESSIONAL SILIKON IMPERMEABILIZZANTE LUBRIFICANTE (400 ml)

Impermeabilizzante e lubrificante.
Resiste all'acqua e allo sfregamento.
Protegge da gelo e corrosione.
Ideale per le guarnizioni.

PROFESSIONAL SVITOL SILIKON WATERPROOFING LUBRICANT (400 ml)

*Lubricant and waterproofing
Resistant to water and rubbing
Protects from frost and corrosion
Ideal for seals*



26 720 0470

SVITOL PROFESSIONAL LUBRIFICANTE MULTIUSO SPECIALE OFFICINE (400 ml)

Lubrificante multiuso, protettivo e detergente, specifico per autofficine e autoriparatori.

Non contiene silicone: ideale per utilizzo in carrozzeria.

PROFESSIONAL SVITOL SPECIAL MULTI-PURPOSE LUBRICANT FOR GARAGES (400 ml)

*Multipurpose lubricant
protecting and cleansing
specific for workshops and garages.
Does not contains silicone
ideal for use in body shop*



26 720 0480

SVITOL PROFESSIONAL GRASSO LUBRIFICANTE AD ALTE PRESTAZIONI PTFE (400 ml)

Grasso lubrificante spray ad alte prestazioni
Grasso spray ad alte prestazioni.
Diminuisce l'attrito e resiste a forti pressioni.
Lunga durata.

Non attira sporco e impurità.

SVITOL PROFESSIONAL GREASE HIGH PERFORMANCE LUBRICATING GREASE (400 ml)

*High performance long lasting lubricant grease.
Does not attract dust and impurities*



26 720 0490

SVITOL PROFESSIONAL LUBRIFICANTE AL LITIO (400 ml)

Lubrificante al litio ad alta viscosità
Lunga resistenza all'acqua e all'usura.
Grasso lubrificante ad alta viscosità.
Sicuro anche su gomma e plastiche.

SVITOL PROFESSIONAL LITHIUM LUBRICANT (400 ml)

*High-viscosity lithium lubricant
Long-lasting resistance to water and use
Safe on rubber and plastic*



26 720 0500

SVITOL PROFESSIONAL PULITORE CONTATTI (400 ml)

Protegge dall'ossidazione e dall'umidità.
Disossida e riattiva i contatti ossidati.
Sicuro su plastiche, metalli e gomma.

SVITOL PROFESSIONAL CONTACTS CLEANER (400 ml)

*Protects from oxidation and moisture
Deoxidizes and reactivates contacts
Does not damage rubber and plastic parts*



26 720 0400



FRENAFILETTI MEDIO (50 ml)

Frenatura di prigionieri, dadi e bulloni non soggetti a smontaggio. Prodotto a bassa viscosità.

Elimina gli allentamenti dovuti a vibrazioni, urti, sbalzi di temperatura. Impedisce la corrosione ed il grippaggio.

THREADLOCKER MEDIUM (50 ml)

Tightening of studs, nuts and bolts not subject to removal. Low viscosity product. Avoid loosening due to vibrations, shocks and temperature changes.

Prevents corrosion and seizing up. Permanent tightening.



26 720 0170



FRENAFILETTI FORTE (10 ml)

Frenatura di prigionieri, dadi e bulloni non soggetti a smontaggio. Prodotto a bassa viscosità.

Elimina gli allentamenti dovuti a vibrazioni, urti, sbalzi di temperatura. Impedisce la corrosione ed il grippaggio. Frenatura permanente.

THREADLOCKER STRONG (10 ml)

Tightening of studs, nuts and bolts not subject to removal. Low viscosity product. Avoid loosening due to vibrations, shocks and temperature changes.

Prevents corrosion and seizing up. Permanent tightening.



26 720 0640



PULITORE FRENI E METALLI (500 ml)

Prodotto spray per la pulizia di freni a tamburo, a disco, pinze e ceppi. Dissolve e rimuove rapidamente grasso, olio, residui, ecc.

MOTORCYCLE BRAKES AND METAL PARTS CLEANER (500 ml)

Spray products for cleaning brake drums, disks, calipers and brake shoes.

Quickly dissolves and removes grease, oil and dirt



26 720 0370



STARTER SPRAY (200 ml)

Applicazione: motore.

Facilita l'avviamento dei motori diesel e benzina durante la stagione invernale, assicurando sempre una rapida accensione anche a temperature molto basse.

Facilitates starting during winter season, always ensuring a fast ignition even at very low temperatures.



26 720 0290



PULITORE INIETTORI BENZINA (250 ml)

Ripristina con effetto immediato l'efficacia del sistema di alimentazione.

Pulisce all'istante e disincrosta gli iniettori. Scioglie depositi e residui nel sistema di alimentazione.

Migliora la combustione

FUEL INJECTORS CLEANER (250 ml)

Restore with immediate effect the efficiency of the power system.

Instantly cleans and descaling the injectors.

Dissolves deposits and wastes in power system improves the combustion



26 720 0420



NEW

PULITORE SISTEMA ASPIRAZIONE E CARBURATORE (Conf. 500 ml)

Applicazione: per motori alimentati

a benzina, gpl, metano.

Pulisce ed elimina i depositi nei condotti di aspirazione dell'aria senza la necessità di smontaggio. Scioglie gomme, lacche ed ogni genere di depositi nei corpi farfallati. Indicato per la pulizia dei carburatori.

CLEANER CARBURETOR

It cleans and eliminates debris in the air intake ducts, without having to take them down. It dissolves rubber, build-up and every type of debris contained inside the throttle body. It is suitable for cleaning carburetors.

It restores CO and HC values.

It is suitable for all single-point, multi-point injection engines, throttle bodies and carburetors.



26 720 0130

MOTORSIL D ROSSA pasta per guarnizioni 60 gr
Tenuta di accoppiamenti meccanici, termomeccanici, chimici, elettronici, elettromeccanici, che operino in condizioni particolarmente difficili.

RED MOTORSIL D GASKET SEALANT

Sealant for mechanical, thermo-mechanical, chemical, electronic, electro-mechanical couplings working in particularly difficult conditions.



26 720 0310

MASTICE PER GUARNIZIONE (100 ml)

Posizionamento e fissaggio di ogni tipo di guarnizione tradizionale. Alto potere adesivo, assicura una tenuta perfetta anche su superfici non regolari. Resiste ad oli, benzina, fluidi refrigeranti e alle pressioni.

SEALING GASKET CEMENT (100 ml)

Positioning and securing of any type of standard gasket. High power adhesive, ensuring a perfect seal also on irregular surfaces. Resistant to oils, gas, refrigerant fluids and pressure.



26 720 0710

PASTA MONTAGGIO MARMITTE

EXHAUST-MUFFLER SEALANT

80 ml



26 720 0140

MOTORBLACK NERA pasta per guarnizioni 60 gr

Sigillatura coppa olio motori Fire e giunti dinamici, differenziale, scatola cambio, pompa acqua.

BLACK MOTORBLACK GASKET SEALANT

Sealant for Fire engine oil sump and dynamic joints, differentials, gearboxes, coolant pumps.



26 720 0550

RIPARA METALLO (57 gr)

Pronto all'uso. Forte, facile, rapido. Applicabile anche in presenza di fuoriuscita di acqua. Aderisce anche su superfici bagnate. Non ritira durante l'indurimento. Dopo l'indurimento, può essere trapanato, levigato, lavorato, verniciato. Serve per riparare, ricostruire, otturare, sigillare, stuccare metallo, ferro, alluminio, rame, ottone, bronzo ghisa, piombo e plastiche dure. Ripara tubi, valvole, serbatoi, parti di motore, arnesi di metallo, condotti per l'aria, parti di bici, moto ed auto

METAL REPAIRER (57 gr)

Ready to use. Strong, easy, fast. Applicable even in the presence of leakage of water. Adheres to wet surfaces. Non-shrinking during hardening. After curing, it can be drilled, sanded, machined, painted. It is used to repair, rebuild, fill, seal, caulk metal, iron, aluminum, copper, brass, bronze, cast iron, lead, and hard plastics. Repair pipes, valves, tanks, motor parts, metal tools, air ducts, parts of bicycles, motorcycles and cars.



26 720 0570

CARBOSILICIUM Acqua Grana Fine

(scatola in metallo 70 ml)

Prodotto per la rapida smerigliatura lucidatura delle valvole e dei condotti dei motori a combustione interna. Massimo grado di purezza. Durezza elevatissima. Smerigliatura perfetta.

CARBOSILICIUM WATER (Fine-grain)

Product for the rapid grinding polishing of valves and ducts of internal combustion engines.

Maximum degree of purity. Extreme hardness. Grinding perfect.



26 720 0580

GRASSO AL LITIO NLGI 3 (0,85 kg)

Speciale Multiuso al Litio indicato in particolare per l'ingrassaggio di mozzi ruote, trasmissioni e cuscinetti.

Elevata stabilità termica per l'utilizzo con temperature da -20°C a +120°C. L'eccellente stabilità meccanica permette di ridurre al minimo la fuoriuscita d'olio. Alta resistenza all'ossidazione per una migliore durata del grasso. Alta resistenza all'acqua per una superiore tenuta all'azione dilavante dell'acqua. Il prodotto si presenta di colore verde scuro e di aspetto pomatoso e filante.

LITHIUM GREASE NLGI 3 (0,85 kg)

High thermal stability for use in temperatures from -20 °C to +120 °C. The excellent mechanical stability allows to minimize the leakage of oil. High oxidation resistance for better durability of the grease. High water resistance. The product has a dark green color.



26 720 0560

GRASSO ALTE PRESTAZIONI (100 ml)

A base di litio complesso. Fortemente adesivo, riduce l'attrito e protegge dall'ossidazione, resiste all'umidità, a carichi elevati, a bassissime ed alte velocità, a temperature elevate per lungo tempo (da -40°C a +240°C con punto di goccia a +300°C). Lubrifica parti rotanti dei macchinari e, in particolare, dei cuscinetti a rotolamento, anche in condizioni estreme di esercizio. Per lubrificare anche macchine da giardino, agricole, movimento terra. Resiste a vibrazioni e centrifugazioni e al dilavamento (acqua dolce o salata). Permette intervalli di manutenzione più lunghi.

HIGH-PERFORMANCE GREASE (100 ml)

Lithium-based complex. Strongly adhesive, reduces friction and protects against oxidation, high resistant, high loads, at very low and high speeds, at high temperatures for a long time (from -40 °C to +240 °C with a drop point in +300 °C). Lubricates the rotating parts of the machinery and, in particular, of the bearings, even in extreme operating conditions. To lubricate garden machines, agricultural, earthmoving. Resistant to vibration and centrifugation and wash-off (freshwater or saltwater). Allows for longer maintenance intervals.



26 720 0150

ROLIN FLUID VERDE LIQUIDO PER RADIATORI (1 Lt.)

Liquido concentrato pluristagionale per radiatori, ad azione protettiva, antigelo e antiebollizione.

può essere utilizzato anche per rabbocchi, in aggiunta a qualsiasi liquido preesistente di colore diverso.

CONDENSED RADIATOR FLUID (1 Lt.)

Multi seasonal concentrated liquid radiator, acting protective, anti-freeze and anti-boiling. can also be used for filling, in addition to any liquid existing in a different color.



26 720 0660

(500 ml)

26 720 0670

(1000 ml)

GRASSO CUSCINETTI ALL LITIO

Grasso al litio complesso, speciale per alte temperature.

Elevata adesività. Ottima resistenza all'acqua. Resiste a vibrazioni e centrifugazione.

Riduce l'attrito e protegge dalla corrosione. Altissima resistenza meccanica ed elevata resistenza al carico.

Permette più lunghi intervalli di manutenzione. Temperatura di impiego: da -25°C a +180°C, con punte fino a +220°C.

BEARING LITHIUM GREASE

Lithium complex grease special for high temperatures.

Excellent water resistance.

Resistant to vibrations and centrifugation.

Reduces friction and protects against corrosion.



26 720 0120

LIQUIDO FRENI DOT 4 (175 ml)

Compatibile con tutti i tipi di gommini

impiegati in primo impianto

punto di ebollizione 260° (ERBP)

Punto di ebollizione a umido min. 140°C (WERBP)

BRAKE FLUID DOT 4 (175 ml)

Compatible with all types of rubbers used in O.E.

Boiling point of 260 ° (ERBP)

Wet boiling point min. 140 °C (WERBP)



26 720 0650

TURAFALLE METALLICO (25 gr)

Sigilla ogni tipo di incrinatura nei carter di alluminio. Forte e tenace.

Azione super rapida. Consigliato per sigillare le soffiature di fusione.

Sigilla le saldature imperfette delle riparazioni del monoblocco. Monodose facile da usare.

METALLIC SEALING COMPOUND (25 gr)

Seals every kind of cracking in alloy crankcase.

Strong and tenacious.

Super fast action.



26 720 0590

ACQUAZERO (400 ml)

Lava, lucida e protegge la carrozzeria di auto, scooter, camper, senza l'utilizzo di acqua: è sufficiente spruzzarlo sulla superficie da trattare e poi passare un panno di cotone asciutto. E' ideale per la carrozzeria, ma valido anche per le gomme e le parti in plastica. La formulazione a base di speciali cere nutritive, oltre a catturare e rimuovere la polvere, escrementi di uccelli, insetti, sporco in genere, lascia la superficie trattata perfettamente lucida e protetta.

ACQUAZERO CLEANER (400 ml)

Washes, polishes and protects the bodywork of cars, scooters, motor homes, without the use of water: just spray it on the surface to be treated and then wipe with a dry cotton. Ideal for the body, but also valid for the tires and plastic parts. The formulation based on special waxes nutrients, as well as capture and remove dust, bird droppings, insects, dirt in general, leaving the treated surface perfectly polished and protected.



26 720 0300

PELLE DI DAINO SINTETICA

Wizy pelle sintetica prima qualità in contenitore.

Confezione : 35x40 cm

SYNTHETIC LEATHER

Wizy synthetic leather top quality 'in box

Packaging: 35x40 cm



26 720 0220

PASTA LAVAMANI (5 lt)

SOOTHING HAND CLEANING PASTE



26 720 0700

SMASH LUCIDA CRUSCOTTI

DASHBOARD CLEANER

600 ml



26 720 0390

IMPERMEABILIZZANTE (200 ml)

Impermeabilizzante per tutti i materiali porosi.

FULCRON WATERPROOFING (200 ml)

Water proofing for all porous materials.



26 720 0200

(500 ml)

26 720 0210

(5 Lt.)

**FULCRON CONCENTRATO
SUPERPULITORE SGRASSANTE
NON TOSSICO**

Sgrassante per tutte le superfici di auto, industria, casa, caravaning, Nautica, tempo Libero, ecc.
FULCRON CONDENSED GREASE REMOVER

For all surfaces: cars, industry, home, caravans, boats, leisure, etc.



26 720 0380

NEUTRALITE ACIDO BATTERIE (5 Kg.)

BATTERY ACID NEUTRALIZER AND ABSORBER

(5 Kg.)



26 720 0360

RINNOVA FANALI (150 gr.)

Pasta per la lucidatura manuale di fari opacizzati e può essere usato anche per la lucidatura di parabrezza di scooter o cupolini di moto.

HEADLIGHT LENS CLEANING PASTE (150 gr.)

Designed to restore the transparency of motorcycle lights and for the brightness windscreens.



26 720 9900



Colore: Giallo Traffico
Colour: Traffic Yellow



26 720 9901



Colore: Arancio Puro
Colour: Pure Orange



26 720 9902



Colore: Rosso Fuoco
Colour: Flame Red



26 720 9903



Colore: Rosso Traffico
Colour: Traffic Red



26 720 9904



Colore: Rosa Chiaro
Colour: Light Pink



26 720 9905



Colore: Viola Erica
Colour: Heather Violet



26 720 9906



Colore: Lilla Bluastro
Colour: Blue Lilac



26 720 9907



Colore: Blu Napoli
Colour: Naples Blue



26 720 9908



Colore: Blu Traffico
Colour: Traffic Blue



26 720 9909



Colore: Turchese
Colour: Turquoise Blue



26 720 9910



Colore: Grigio Argento
Colour: Silver Grey



26 720 9912



Colore: Verde Menta
Colour: Mint Green



26 720 9913



Colore: Marrone Cioccolata
Colour: Chocolate Brown



26 720 9914



Colore: Nero Opaco
Colour: Black Matt



26 720 9915



Colore: Bianco Opaco
Colour: Pure White Matt



26 720 9916



Colore: Trasparente Opaco
Colour: *Transparent Matt*



26 720 9917



Colore: Trasparente Lucido
Colour: *Transparent Glossy*



26 720 9918



Colore: Argento
Colour: *Silver*



26 720 9919



Colore: Oro
Colour: *Gold*



26 720 9920



Colore: Giallo Fluo
Colour: *Fluo Yellow*



26 720 9921



Colore: Rosso Fluo
Colour: *Fluo Red*



26 720 9922



Colore: Fuxia Fluo
Colour: *Fluo Fuxia*



26 720 9923



Colore: Verde Fluo
Colour: *Fluo Green*



26 720 9924



Colore: Blu Fluo
Colour: *Fluo Blue*



26 720 9925



Colore: Arancio Fluo
Colour: *Fluo Orange*



26 720 9926



Colore: Blue Horizon
Colour: *Blue Horizon*



26 720 9927



Colore: Beige Sand
Colour: *Beige Sand*



26 720 9928



Colore: Verde Canna
Colour: *Reed Green*



26 720 9929



Colore: Kaki Olive
Colour: *Kaki Olive*



26 720 9930



Colore: Grigio Verde
Colour: *Grey Green*



26 720 9931



Colore: Grigio Scuro
Colour: Dar Grey



26 720 9932



Colore: Mostarda
Colour: Mustard



26 720 9933



Colore: Glitter Argento
Colour: Silver Glitter



26 720 9934



Colore: Glitter Oro
Colour: Gold Glitter



26 720 9936



Colore: Grigio Titanio
Colour: Titanium grey



26 720 9937



Colore: Nero metalizzato
Colour: Black metalized



26 720 9941



Colore: Verde Kawasaki
Colour: Kawasaki Green



26 720 9938



PISTOLA PER BOMBOLETTA SPRAY
SPRAY CAN GUN



26 720 9939



COPRI VALVOLA CERCHI
RIM VALVE MASKING PROTECTION



26 720 9940



KIT 15 CARTONCINI MASCHERATURA
15 PCS RIM MASKING CARD



26 720 9942



EROGATORE BIANCO (RICAMBIO)
WHITE CAN NOZZLE (SPARE)



26 720 9943



EROGATORE NERO - SPRUZZO FINE
BLACK CAN NOZZLE (ROUND SPRAY)



26 720 9935



EROGATORE ROSSO PROFESSIONALE
REGOLABILE - SPRUZZO A VENTAGLIO
FINO A 20cm
RED CAN NOZZLE (WIDE SPRAY TO 20 cm)





28 800 0630 

LUCCHETTO CATENA 10 X 10 X 1500

- Catena in acciaio temperato a maglia quadra.
- Rivestimento in nylon antigraffio.
- Lucchetto disc lock separabile con serratura sistema antiacqua/polvere
- Tre chiavi piatte
- Una con mini lampadina incorporata.

LOCK AND CHAIN 10 X 10 X 1500

- Hexagonal chain in hardened-steel
- Covered with anti-scratch nylon
- Separate disc lock
- Waterproof and anti-dust lock
- Three flat keys
- Integrated mini bulb



28 800 0640 

LUCCHETTO DISC LOCK 70x155 mm

- Serratura sistema antiacqua/polvere
 - Tre chiavi piatte
 - Una con mini lampadina incorporata
- DISC LOCK 70x155 mm**
- Waterproof and anti-dust lock
 - Three flat keys
 - Integrated mini-bulb



28 800 0690 

LUCCHETTO PITONE MONOBLINDO

- Lunghezza 1200 mm
- Spessore 22 mm
- Chiave piatta
- Rivestimento in nylon antigraffio
- Testa ricoperta in resina
- Confezione in blister

SECURITY LOCKABLE CHAIN

- Length 1200 mm
- Thickness 22 mm
- Flat key
- Covered with anti-scratch nylon
- Resin-covered head lock
- Blister packaging



28 800 0400 

NUOVO PITONE MONOBLINDO (Chiave piatta)

- Lunghezza 1200 mm
- Ø 18 mm
- Copertura antiacqua e polvere per la serratura
- Confezione in blister

NEW SECURITY LOCKABLE CHAIN (Flat key)

- Length 1200 mm
- Ø 18 mm
- Waterproof and anti-dust lock cover
- Blister packaging





LUCCHETTI ANTIFURTO VARI

VARIOUS LOCKS

28 800 0091 

MAXI DISK LOCK DE-LUXE

- Lucchetto al freno disco perno Ø 10 mm.
- Serratura con tappo di protezione
- Colori: rosso e giallo
- Chiave piatta
- Completo di borsetta
- Confezione in blister
- *Disc lock with Ø 10 pin*
- *Lock protection cover*
- *Colours: Red and Yellow*
- *Flat Key*
- *Bag included*
- *Blister packaging*

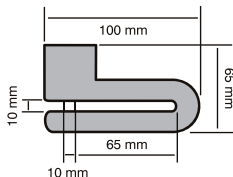

28 800 0101 

MINI DISK LOCK DE-LUXE

- Lucchetto al freno disco perno Ø 6 mm.
- Serratura con tappo di protezione
- Colori: rosso e giallo
- Chiave piatta
- Completo di borsetta
- Confezione in blister
- *Disc lock with Ø 6 pin*
- *Lock protection cover*
- *Colours: Red and Yellow*
- *Flat Key*
- *Bag included*
- *Blister packaging*

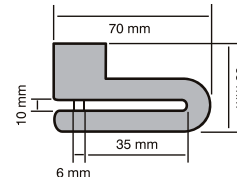

28 800 0130 

MICRO DISK LOCK

- Colorato
- Con borsetta
- Lucchetto al freno disco, perno Ø 6 mm
- Chiusura in acciaio cromato
- con meccanismo automatico.
- Chiavi tubolari.
- Confezione da 24 pezzi in blister
- *Coloured bag included*
- *Disc lock with Ø 6 mm pin*
- *Automatic chromed steel locking*
- *Tubular keys*
- *24 pcs blister packaging*

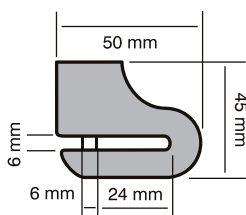

28 800 0120 

- Senza borsetta
- *Bag not included*

28 800 9000 

CAVO SPIRALE 4 x 1500 mm

- Posizionato sul manubrio è efficace
- per ricordare di non partire
- con lucchetto disco inserito
- Applicabile a tutti i lucchetti al disco
- Colori: rosso / giallo

SECURITY LOOP-CABLE 4 x 1500 mm

- *If installed on handlebar it reminds you not to start with the disc lock inserted*
- *Suitable for all disc locks*
- *Colours: Red and Yellow*



28 800 0650 

DISC LOCK CON ALLARME SONORO

- Lucchetto al freno disco perno Ø 6 mm
- Doppi sensori d'urto e movimento
- Attivazione automatica dell'allarme 30 secondi dopo la chiusura del lucchetto
- Finitura lucida
- Completo di borsetta
- Batterie (Tipo LR44 6 pezzi incluse)

DISC LOCK WITH ALARM

- *Disc lock with Ø 6 mm pin*
- *Double shock and motion sensors*
- *After locking the self-arming system will be set automatically 30 seconds later*
- *Glossy finish*
- *Bag included*
- *Batteries (Type LR44 - 6 pcs included)*

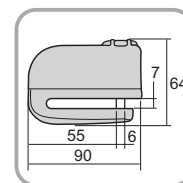

28 800 0270 

CATENA IN ACCIAIO CEMENTATO

ricoperta in PVC.

ANTI-THEFT PVC COATED CHAIN

Ø 4,5 mm - Lungh. - Length 80 cm







▶ BIKE SERVICE













BIKE SERVICE



















ATTREZZI MANUTENZIONE IMPIANTO ELETTRICO - *ELECTRIC SYSTEM TOOLS*

COD. RMS RMS CODE	BARCODE	CODICE BIKESERVICE BIKESERVICE CODE	DESCRIZIONE	DESCRIPTION
26 700 5000		BS1031	Kit guaina per cablaggi elettrici Termoretraibile impermeabile	<i>Waterproof heat shrinkable tube set</i>
26 700 5010		BS1815	Attrezzo smontaggio connettori elettrici	<i>Wire terminal tool</i>
26 700 5020		BS1814	Attrezzo smontaggio connettori elettrici	<i>Wire terminal tool</i>
26 700 5040		BS9484	Pinza professionale spelafili	<i>Professional wire stripper</i>

ATTREZZI MANUTENZIONE MOTORE - *ENGINE SERVICE TOOLS*

COD. RMS RMS CODE	BARCODE	CODICE BIKESERVICE BIKESERVICE CODE	DESCRIZIONE	DESCRIPTION
26 700 5310		BS2300	Attrezzo separatore carter motore	<i>Crank case separator tool set</i>
26 700 5550		BS4017	Attrezzo estrazione cuscinetti	<i>Mechanical bearing puller set</i>
26 700 5150		BS3032	Attrezzo montaggio fasce pistoni	<i>Piston ring compressor set</i>
26 700 5230		BS0244	Attrezzo controllo perdite impianti Raffreddamento - radiatori	<i>Cooling system & radiator pressure test</i>
26 700 5280		BS6659	Set 8 attrezzi smontaggio - montaggio filtri olio	<i>8 Pc oil filter wrench set</i>
26 700 5300		BS6656	Attrezzo universale per smontaggio filtri olio a cartuccia	<i>Universal 3 leg oil filter wrench (60~125mm)</i>
26 700 5290		BS8006	Vasca 4 litri drenaggio - trasporto olio esausto	<i>4L portable oil drain can</i>
26 700 5090		BS2201A	Attrezzo regolazione valvole 3mm	<i>3Mm tappet adjusting tool</i>
26 700 5100		BS2201B	Attrezzo regolazione valvole 4mm	<i>4Mm tappet adjusting tool</i>
26 700 5110		BS2201C	Attrezzo regolazione valvole 8mm	<i>8Mm tappet adjusting tool</i>
26 700 5120		BS2201D	Attrezzo regolazione valvole 9mm	<i>9Mm tappet adjusting tool</i>
26 700 5130		BS2201E	Attrezzo regolazione valvole 10mm	<i>10Mm tappet adjusting tool</i>

COD. RMS RMS CODE	BARCODE	CODICE BIKESERVICE BIKESERVICE CODE	DESCRIZIONE	DESCRIPTION
26 700 5140		BS2201F	Attrezzo regolazione valvole vite testa piatta	<i>Flat screw tappet adjusting tool</i>
26 700 5160		BS3105	Spessimetro misure metriche - pollici	<i>Blade feeler gauge</i>
26 700 5170		BS9828	Attrezzo smontaggio semiconi valvole	<i>Valve spring collet remove - replace tool</i>
26 700 5180		BS9829	Attrezzo smontaggio semiconi valvole	<i>Valve spring collet remove/replace tool</i>
26 700 5580		BS3550	Set professionale per apertura chiusura catene distribuzione	<i>Timing chain breaking riveting tool kit</i>
26 700 5050		BS9132	Bussola candela 14 mm extrasottile	<i>Extra thin wall spark socket 14 mm</i>
26 700 5060		BS9133	Bussola candela 16 mm extrasottile	<i>Extra thin wall spark socket 16 mm</i>
26 700 5070		BS9134	Bussola candela 18 mm extrasottile	<i>Extra thin wall spark socket 18 mm</i>
26 700 5080		BS9135	Bussola candela 20,8 mm extrasottile	<i>Extra thin wall spark socket 20.8 mm</i>
26 700 5320		BS2405	Estrattore volano m 22 x 1,5 mm	<i>Flywheel puller m 22 x 1.5 mm</i>
26 700 5330		BS2441	Estrattore volano m 19 x 1,0 mm	<i>Magnetic flywheel puller m19x p1.0 mm</i>
26 700 5340		BS2442	Estrattore volano m 24 x 1,0 mm	<i>Magnetic flywheel puller m 24 x p1.0 mm</i>
26 700 5350		BS2443	Estrattore volano m 27 x 1,0 mm	<i>Magnetic flywheel puller m27 x p1.0 mm</i>
26 700 5360		BS2444	Estrattore volano m 27 x 1,25 mm	<i>Magnetic flywheel puller m27 x 1.25 mm</i>
26 700 5370		BS2470	Estrattore volano m 26 x 1,0 mm	<i>Magnetic flywheel puller m26 x p1.0Mm</i>
26 700 5380		BS2472	Estrattore volano m 28 x 1,0 mm	<i>Magnetic flywheel puller m28 x p1.0Mm</i>
26 700 5390		BS2473	Estrattore volano m 30 x 1,5 mm	<i>Magnetic flywheel puller m30 x p1.5Mm</i>
26 700 5400		BS2477	Estrattore volano m 22 x 1,5 mm	<i>Magnetic flywheel puller m22 x p1.5Mm</i>
26 700 5410		BS2479	Estrattore volano m26 x 1,5mm	<i>Magnetic flywheel puller m26 x p1.5Mm</i>
26 700 5420		BS2487	Estrattore volano m35 x 1,0mm	<i>Magnetic flywheel puller m35 x p1.0Mm</i>
26 700 5460		BS4224	Attrezzo montaggio / smontaggio sonda lambda 11/16"	<i>11/16" Oxygen sensor socket tool</i>
26 700 6580		BS2461	Estrattore volano femmina m24x1,5	<i>Magneto flywheel puller m24x1,5</i>
26 700 6590		BS2462	Estrattore volano femmina m26x1,0	<i>Magneto flywheel puller m26x1,0</i>
26 700 6600		BS2463	Estrattore volano femmina m30x1,5	<i>Magneto flywheel puller m30x1,5</i>
26 700 6610		BS2464	Estrattore volano femmina m30x1,0	<i>Magneto flywheel puller m30x1,0</i>
26 700 6620		BS2465	Estrattore volano femmina m30x1,5 50	<i>Magneto flywheel puller m30x1,5 50</i>
26 700 6630		BS2467	Estrattore volano femmina m33x1,5	<i>Magneto flywheel puller m33x1,5</i>
26 700 6640		BS2469	Estrattore volano femmina m35x1,5	<i>Magneto flywheel puller m35x1,5</i>
26 700 6650		BS2483	Estrattore volano femmina m24x1,0	<i>Magneto flywheel puller m24x1,0</i>
26 700 6660		BS2484	Estrattore volano femmina m28x1,0	<i>Magneto flywheel puller m28x1,0</i>

COD. RMS RMS CODE	BARCODE	CODICE BIKESERVICE BIKESERVICE CODE	DESCRIZIONE	DESCRIPTION
26 700 6670		BS2485	Estrattore volano femmina M30x1,25	<i>Magneto flywheel puller M30x1,25</i>
26 700 6680		BS2486	Estrattore volano femmina M32x1,5	<i>Magneto flywheel puller M32x1,5</i>
26 700 6700		BS2488	Estrattore volano femmina M38x1,5	<i>Magneto flywheel puller M38x1,5</i>
26 700 6710		BS2489	Estrattore volano femmina M42x1,5	<i>Magneto flywheel puller M42x1,5</i>
26 700 5470		BS4224C	Attrezzo Montaggio / Smontaggio Sonda Lambda 22mm	<i>22mm Oxygen Sensor Socket Tool</i>
26 700 5480		BS6101	Attrezzo Per Modificare/ Adattare Diametro Tubi Scarico 29-44mm	<i>29-44mm Exhaust Pipe Expander</i>
26 700 5490		BS6103	Attrezzo Per Modificare/ Adattare Diametro Tubi Scarico 38-64mm	<i>38-64mm Exhaust Pipe Expander</i>
26 700 5950		BS5201	Attrezzo Smontaggio Molle Impianto Di Scarico	<i>Exhaust Springs U Hook Handle</i>
26 700 5190		BS2311	Attrezzo Montaggio / Smontaggio Prigionieri M6 X 1.00mm	<i>M6 X P1.0mm Stud Remove And Install Tool</i>
26 700 5200		BS2312	Attrezzo Montaggio / Smontaggio Prigionieri M8 X 1,25mm	<i>M8 X P1.25mm Stud Remove And Install Tool</i>
26 700 5210		BS2313	Attrezzo Montaggio / Smontaggio Prigionieri M10 X 1,25mm	<i>M10 X P1.25mm Stud Remove And Install Tool</i>
26 700 5220		BS2314	Attrezzo Montaggio / Smontaggio Prigionieri M10 X 1,5mm	<i>M10 X P1.5mm Stud Remove And Install Tool</i>
26 700 5430		BS4328	Attrezzo Universale Per Montaggio / Smon- taggio Prigionieri	<i>Universal Stud Setter And Extractor</i>
26 700 6520		BS2302	Attrezzo rimozione tappi ispezione motore	<i>Timing and inspection plug tool</i>
26 700 6530		BS9947	Attrezzo montaggio valvole	<i>Fitting valves tool</i>

ATTREZZI MANUTENZIONE TRASMISSIONE FINALE - TRANSMISSION TOOLS



COD. RMS RMS CODE	BARCODE	CODICE BIKESERVICE BIKESERVICE CODE	DESCRIZIONE	DESCRIPTION
26 700 5500		BS6728	Attrezzo Bloccaggio Campana Frizione Variatore	Heavy Duty Pulley Holder Wrench
26 700 5510		BS9861	Chiave 34mm Per Smontaggio Frizione Variatore	Clutch Nut Wrench 34mm
26 700 5520		BS9862	Chiave 39mm Per Smontaggio Frizione Variatore	Clutch Nut Wrench 39mm
26 700 5530		BS9863	Chiave 41mm Per Smontaggio Frizione Variatore	Clutch Nut Wrench 41mm
26 700 5540		BS9864	Chiave 46mm Per Smontaggio Frizione Variatore	Clutch Nut Wrench 46mm
26 700 5590		BS4532	Attrezzo Per Controllo Tensione Cinghia Trasmissione	Belt Tension Gauge
26 700 5600		BS35101	Set Professionale Per Apertura/Chiusura Catene Trasmissione	Universal Transmission Chain Repairing Master Set

ATTREZZI MANUTENZIONE TELAIO - FRAME SERVICE TOOLS





COD. RMS RMS CODE	BARCODE	CODICE BIKESERVICE BIKESERVICE CODE	DESCRIZIONE	DESCRIPTION
26 700 5560		BS9144	Set 17 Pezzi Per Installazione / Rimozione Cuscinetti	17 Pcs Bushing Driver Set (Metric)
26 700 5570		BS4201	Attrezzo Estrazione Cuscinetti Sterzo	Steering Bearing Remove Tool
26 700 5890		BS9892	Estrattore Cuscinetto Piastra Inferiore Sterzo	Steering/ Lower Triple Clamp Bearing Puller
26 700 5900		BS9893	Attrezzo Montaggio Cuscinetto Piastra Inferiore Sterzo	Steering/ Lower Triple Clamp Bearing Installer Tool Set
26 700 5610		BS0350	Chiave A Settore 19-51mm	Chain Adjust C Hook Wrench 19-51mm
26 700 5620		BS0351	Chiave A Settore 32-76mm	Chain Adjust C Hook Wrench 32-76mm
26 700 5630		BS0352	Chiave A Settore 51-120mm	Chain Adjust C Hook Wrench 51-120mm
26 700 6000		BS5530	Attrezzo Smontaggio / Montaggio Perno Ruota Anteriore	Front Wheel Splindle Remove Tool
26 700 5030		BS4531	Attrezzo Per Lubrificazione Interna Cavi Gas-Freno-Frizione	Cable Wire Lubrication Tool

ATTREZZI IMPIANTO FRENANTE - BRAKE SYSTEM TOOLS

COD. RMS RMS CODE	BARCODE	CODICE BIKESERVICE BIKESERVICE CODE	DESCRIZIONE	DESCRIPTION
26 700 5930		BS0044	Attrezzo Smontaggio Molle Freno	<i>Brake Spring Hook</i>
26 700 5940		BS0245	Tester Digitale Per Fluido Impianti Frenanti	<i>Brake Fluid Condition Tester</i>
26 700 5960		BS5582	Pompa Per Disaerazione Impianto Frenante	<i>Vacuum Pump And Brake Bleeder Kit</i>
26 700 5970		BS9870	Attrezzo Per Allargare Pistoni Pinza Freno 30mm	<i>Disc Brake Spreader 30mm</i>
26 700 5980		BS9871	Attrezzo Per Allargare Pistoni Pinza Freno 70mm	<i>Disc Brake Spreader 70mm</i>

ATTREZZI FORCELLA - FRONT FORK SERVICE TOOLS

COD. RMS RMS CODE	BARCODE	CODICE BIKESERVICE BIKESERVICE CODE	DESCRIZIONE	DESCRIPTION
26 700 5640		BS9730A	Bussola ½" Chiave Maschio 8mm	<i>½" Bit Socket 8mm</i>
26 700 5650		BS9730B	Bussola ½" Chiave Maschio 10mm	<i>½" Bit Socket 10mm</i>
26 700 5670		BS9730C	Bussola ½" Chiave Maschio 12mm	<i>½" Bit Socket 12mm</i>
26 700 5820		BS9827Q	Attrezzo Montaggio Paraoli Forcella 27mm	<i>Front Fork Dust Seal Driver 27mm</i>
26 700 5830		BS9827R	Attrezzo Montaggio Paraoli Forcella 30mm	<i>Front Fork Dust Seal Driver 30mm</i>
26 700 5840		BS9827S	Attrezzo Montaggio Paraoli Forcella 31mm	<i>Front Fork Dust Seal Driver 31mm</i>
26 700 5680		BS9827A	Attrezzo Montaggio Paraoli Forcella 32mm	<i>Front Fork Dust Seal Driver 32mm</i>
26 700 5690		BS9827B	Attrezzo Montaggio Paraoli Forcella 33mm	<i>Front Fork Dust Seal Driver 33mm</i>
26 700 5850		BS9827T	Attrezzo Montaggio Paraoli Forcella 34mm	<i>Front Fork Dust Seal Driver 34mm</i>
26 700 5700		BS9827C	Attrezzo Montaggio Paraoli Forcella 35mm	<i>Front Fork Dust Seal Driver 35mm</i>
26 700 5710		BS9827D	Attrezzo Montaggio Paraoli Forcella 36mm	<i>Front Fork Dust Seal Driver 36mm</i>
26 700 5720		BS9827E	Attrezzo Montaggio Paraoli Forcella 37mm	<i>Front Fork Dust Seal Driver 37mm</i>
26 700 5730		BS9827F	Attrezzo Montaggio Paraoli Forcella 38mm	<i>Front Fork Dust Seal Driver 38mm</i>
26 700 5740		BS9827G	Attrezzo Montaggio Paraoli Forcella 39mm	<i>Front Fork Dust Seal Driver 39mm</i>

COD. RMS RMS CODE	BARCODE	CODICE BIKESERVICE BIKESERVICE CODE	DESCRIZIONE	DESCRIPTION
26 700 5750		BS9827H	Attrezzo Montaggio Paraoli Forcella 40mm	Front Fork Dust Seal Driver 40mm
26 700 5760		BS9827J	Attrezzo Montaggio Paraoli Forcella 41mm	Front Fork Dust Seal Driver 41mm
26 700 5860		BS9827U	Attrezzo Montaggio Paraoli Forcella 42mm	Front Fork Dust Seal Driver 42mm
26 700 5770		BS9827K	Attrezzo Montaggio Paraoli Forcella 43mm	Front Fork Dust Seal Driver 43mm
26 700 5780		BS9827L	Attrezzo Montaggio Paraoli Forcella 45mm	Front Fork Dust Seal Driver 45mm
26 700 5790		BS9827M	Attrezzo Montaggio Paraoli Forcella 46mm	Front Fork Dust Seal Driver 46mm
26 700 5870		BS9827V	Attrezzo Montaggio Paraoli Forcella 47mm	Front Fork Dust Seal Driver 47mm
26 700 5800		BS9827N	Attrezzo Montaggio Paraoli Forcella 48mm	Front Fork Dust Seal Driver 48mm
26 700 5880		BS9827W	Attrezzo Montaggio Paraoli Forcella 49mm	Front Fork Dust Seal Driver 49mm
26 700 5810		BS9827P	Attrezzo Montaggio Paraoli Forcella 50mm	Front Fork Dust Seal Driver 50mm
26 700 5920		BS41500	Attrezzo Inserimento/ Verifica Livello Olio Forcella	Fork Oil Level Gauge Tool





ATTREZZI MANUTENZIONE PNEUMATICI - TIRE SERVICE TOOLS



COD. RMS RMS CODE	BARCODE	CODICE BIKESERVICE BIKESERVICE CODE	DESCRIZIONE	DESCRIPTION
26 700 6010		BS9952	Set 3 Pezzi Protezione Cerchi Per Smontaggio Pneumatici	3 Pcs Rims Protector Set
26 700 6020		BS3238	Manometro Digitale Pressione Pneumatici	Digital Tire Pressure Gauge
26 700 6030		BS3699	Attrezzo Montaggio / Smontaggio Valvole Pneumatici Tubeless	Tire Valves Extractor Bar
26 700 6040		BS5603	Leva Smontagomme L 200mm	200mm Tires Lever
26 700 6050		BS5604	Leva Smontagomme L 400mm	400mm Tires Lever
26 700 6060		BS5612	Leva Smontagomme Curva	Curved Type Tires Lever
26 700 6540		BS8008	Attrezzo stallonamento pneumatici	Tire change extruders tool
26 700 6550		BS5610	Fermo per montaggio pneumatici	Tire bead holding tool

ATTREZZI GENERICI - HAND TOOLS

COD. RMS RMS CODE	BARCODE	CODICE BIKESERVICE BIKESERVICE CODE	DESCRIZIONE	DESCRIPTION
26 700 6130		BS6012	Set 8 Pz.Chiavi 6-19mm Combinate	8 Pcs (6-19mm) Multi Driver Wrench Set
26 700 6260		BS7407	Set Chiavi Combinata A Cricchetto 6-19mm	Ratchet Wrench Set 6-19mm
26 700 6150		BS7525	Set 2 Pz.Chiavi A Cricchetto 4 In 1	2 Pcs "4 In 1" Reversible Ratchet Wrench Set
26 700 6220		BS7288	Cricchetto Reversibile 1/4"	1/4" Ratchet Handle
26 700 6220		BS7288	Cricchetto Reversibile 1/4"	1/4" Ratchet Handle
26 700 6230		BS7291	Cricchetto Reversibile 1/2"	1/2" Ratchet Handle
26 700 6080		BS5420	Cricchetto Reversibile 1/2" Con Prolunga (Da 340 A 500mm)	1/2" Drive F Handle Telescoping Ratchet (340-500mm)
26 700 6240		BS5421	Chiave Dinamometrica Digitale 1/4"	1/4" Digital Reading Torque Wrench
26 700 6250		BS5423	Chiave Dinamometrica Digitale 1/2"	1/2" Digital Reading Torque Wrench
26 700 6200		BS9200	Set Bussole Esagonali 1/4"	1/4" Square Drive Bits Socket Set
26 700 6210		BS9202	Set Bussole Esagonali 1/2"	1/2" Square Drive Bits Socket Set
26 700 5910		BS9731	Set Bussola 1/2" Chiave Maschio Tx	3Pc 1/2" Tx-Star Bit Socket Set
26 700 6070		BS1660	Set Chiavi Esagonali A T L 300mm (6-8-10-12-13-14-17-19mm)	300mm Long T-Handle Socket (6.19mm)
26 700 6090		BS9101	Set 9 Pezzi Chiavi Tx Lunghe Con Calamita	9Pc Extra Long Tx-Star Key Set
26 700 6100		BS9103	Set 9 Pezzi Chiavi Esagonali Maschio Lunghe Con Estremita' A Sfera	9Pc Extra Long Ball Point Hex
26 700 5270		BS2008	Giravite Flessibile Con Inserti	Flexible Hose Clamp Nut/ Screw Drivers
26 700 6110		BS9651	Set Cacciavite A Percussione Con Inserti	Impact Driver Set
26 700 6140		BS7030	Attrezzo Magnetico Flessibile Per Raccolta Oggetti	Flexible Magnetic Claw Pick Up Tool
26 700 5240		BS9036	Pinza Chiusura Tubazioni In Gomma Piccola	Hose Clamp Plier
26 700 5250		BS9037	Pinza Chiusura Tubazioni In Gomma Media	Hose Clamp Plier
26 700 5260		BS9041	Pinza Chiusura Tubazioni In Gomma Grande	Hose Clamp Plier
26 700 5440		BS0230	Set 4 Attrezzi Per Rimozione O-Ring / Paraoli (152mm)	4Pc Pick & Hook Set (152mm)
26 700 5450		BS1234	Set 4 Attrezzi Per Rimozione O-Ring / Paraoli (76mm)	4Pc Pick & Hook Set (76mm)
26 700 5990		BS1235	Attrezzo Per Rimuovere O-Ring Paraoli 150mm E 170mm	2Pc Seal Pick Set 150mm & 170mm
26 700 6170		BS2260	Attrezzo Rinforzato Rimozione Guarnizioni 15mm	Reinforced Plastic Scraper 15mm
26 700 6180		BS2261	Attrezzo Rinforzato Rimozione Guarnizioni 30mm	Reinforced Plastic Scraper 30mm
26 700 6190		BS2262	Attrezzo Rinforzato Rimozione Guarnizioni 50mm	Reinforced Plastic Scraper 50mm
26 700 6160		BS4502	Attrezzo Per Rilevamento Profili 250mm	250mm Profile Gauge
26 700 6120		BS02961	Set Riparazione Filettature Metrico	Threaded Coil Insert Repair Kit (Metric)

COD. RMS RMS CODE	BARCODE	CODICE BIKESERVICE BIKESERVICE CODE	DESCRIZIONE	DESCRIPTION
26 700 6280		BS1661	Chiave Esagonale a T L. 300 - 6 mm	<i>T-Handle Socket T.L. 300 - 6 mm</i>
26 700 6290		BS1662	Chiave Esagonale a T L. 300 - 8 mm	<i>T-Handle Socket T.L. 300 - 8 mm</i>
26 700 6300		BS1663	Chiave Esagonale a T L. 300 - 10 mm	<i>T-Handle Socket T.L. 300 - 10 mm</i>
26 700 6310		BS1664	Chiave Esagonale a T L. 300 - 12 mm	<i>T-Handle Socket T.L. 300 - 12 mm</i>
26 700 6320		BS1665	Chiave Esagonale a T L. 300 - 13 mm	<i>T-Handle Socket T.L. 300 - 13 mm</i>
26 700 6330		BS1666	Chiave Esagonale a T L. 300 - 14 mm	<i>T-Handle Socket T.L. 300 - 14 mm</i>
26 700 6340		BS1667	Chiave Esagonale a T L. 300 - 17 mm	<i>T-Handle Socket T.L. 300 - 17 mm</i>
26 700 6350		BS1668	Chiave Esagonale a T L. 300 - 19 mm	<i>T-Handle Socket T.L. 300 - 19 mm</i>
26 700 6560		BS80017	Chiave 3/8 snodata a T	<i>3/8 Jointed T handle wrench</i>
26 700 6570		BS80018	Chiave 1/4 snodata a T	<i>1/4 Jointed T handle wrench</i>
26 700 6360		BS6012A	Chiave Combinata 6 mm	<i>Multi Driver Wrench 6 mm</i>
26 700 6370		BS6012B	Chiave Combinata 8 mm	<i>Multi Driver Wrench 8 mm</i>
26 700 6380		BS6012C	Chiave Combinata 10 mm	<i>Multi Driver Wrench 10 mm</i>
26 700 6390		BS6012D	Chiave Combinata 12 mm	<i>Multi Driver Wrench 12 mm</i>
26 700 6400		BS6012E	Chiave Combinata 13 mm	<i>Multi Driver Wrench 13 mm</i>
26 700 6410		BS6012F	Chiave Combinata 14 mm	<i>Multi Driver Wrench 14 mm</i>
26 700 6420		BS6012G	Chiave Combinata 17 mm	<i>Multi Driver Wrench 17 mm</i>
26 700 6430		BS6012H	Chiave Combinata 19 mm	<i>Multi Driver Wrench 19 mm</i>
26 700 6510		BS7407H	Chiave Combinata a Cricchetto 6 mm	<i>Ratchet Wrench 6 mm</i>
26 700 6440		BS7407A	Chiave Combinata a Cricchetto 8 mm	<i>Ratchet Wrench 8 mm</i>
26 700 6450		BS7407B	Chiave Combinata a Cricchetto 10 mm	<i>Ratchet Wrench 10 mm</i>
26 700 6460		BS7407C	Chiave Combinata a Cricchetto 12 mm	<i>Ratchet Wrench 12 mm</i>
26 700 6470		BS7407D	Chiave Combinata a Cricchetto 13 mm	<i>Ratchet Wrench 13 mm</i>
26 700 6480		BS7407E	Chiave Combinata a Cricchetto 14 mm	<i>Ratchet Wrench 14 mm</i>
26 700 6490		BS7407F	Chiave Combinata a Cricchetto 17 mm	<i>Ratchet Wrench 17 mm</i>
26 700 6500		BS7407G	Chiave Combinata a Cricchetto 19 mm	<i>Ratchet Wrench 19 mm</i>



ESTRATTORI VOLANO - CHIAVI CANDELA

FLYWHEEL PULLERS - SPARK PLUG WRENCH

26 700 0070



ESTRATTORE VOLANO - FLYWHEEL PULLER

Bosch-Ducati-Motoplat
Scooter 50 Malaguti-Aprilia
(con volani Ducati) - Ø 22x1,5 (dx)

26 700 0100



ESTRATTORE VOLANO - FLYWHEEL PULLER

Kimco People-Vivio 125/150 - Movie 125
Honda-Mbk-Yamaha Minarelli - Suzuki
Kawasaki-Peugeot-Malaguti-Aprilia-Beta
Ø 27x1 (sx)



26 700 0080



ESTRATTORE VOLANO - FLYWHEEL PULLER

Kimco Dink 50-Honda-Peugeot
Ø 24x1 (dx)

26 700 0120



ESTRATTORE VOLANO - FLYWHEEL PULLER

Vespa - Pk - Et3 - Px - Ape 50 - Gilera Rv -Rx
Motoplat
Ø 28x1 (dx)

26 700 0090



ESTRATTORE VOLANO - FLYWHEEL PULLER

Piaggio scooter 50 tutti i modelli - *All models*
Ø 26x1 (dx)

26 700 0150



ESTRATTORE SMONTAGGIO FRIZIONE CLUTCH PULLER

Vespa 50 - 90 - 125 Et3
(filetto interno - *Internal thread*)

26 700 0160



ATTREZZO SMONTAGGIO GHIERA FRIZIONE CLUTCH NUT REMOVAL TOOL

Vespa Pe - Px

26 700 0140



ATTREZZO SPINGIDISCO FRIZIONE CLUTCH PRESSURE PLATE TOOL

Vespa 50 - 90 - 125 Et3



26 700 0010



ATTREZZO TENDICAVO FRENO FRIZIONE BRAKE AND CLUTCH CABLE TENSIONER TOOL

26 700 0030



LEVA GOMME CICLOMOTORE - 1 pz. MOPED TIRES LEVER - 1 pc

26 700 0193



SET CHIAVI - KEYS SET

Vespa 50



26 700 9123



SUPPORTO MOTORE ENGINE SUPPORT

Vespa Px • LML

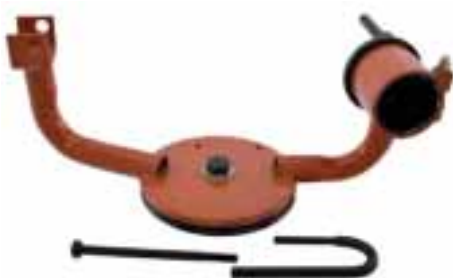



26 700 0180 

CHIAVE CANDELA - SPARK PLUGS WRENCH
Chiave candela ciclomotore
Esagonale - Hexagonal 13x21



26 700 0190 

CHIAVE CANDELA - SPARK PLUGS WRENCH
Chiave candela per ciclomotore
Standard



26 700 0240 

CHIAVE CANDELA A TUBO CON SPINA
SPARK PLUG WRENCH WITH PIN
Esagonale - Hexagonal Ø 16x100



26 700 0250 

Esagonale - Hexagonal Ø 16x140

26 700 0260 

Esagonale - Hexagonal Ø 18x100

26 700 0270 

Esagonale - Hexagonal Ø 21x120

26 700 0200 

CHIAVE CANDELA - SPARK PLUGS WRENCH
Chiave candela vespa 125 Et3
Esagonale - Hexagonal 13x13x21



26 700 0220 

CHIAVE CANDELA - SPARK PLUGS WRENCH
Vespa Px 125 - Px 150
125 - 150 Sprint
Esagonale - Hexagonal 13x11x21 / 22



26 700 0230 

CHIAVE CANDELA SNODATA PER MOTO
ARTICULATED SPARK PLUG WRENCH
Esagonale - Hexagonal Ø 21 - lungh. 230 mm.



26 700 0210 

CHIAVE CANDELA - SPARK PLUGS WRENCH
Vespa 50 - 90
Esagonale - Hexagonal 11x13x21

26 700 0170 

CHIAVE SEBATOIO - TOOL TANK
Vari tipi di Vespa - Various Vespa Models



26 700 0173 

CHIAVE SERBATOIO - TANK TOOL
Vespa Gs 160

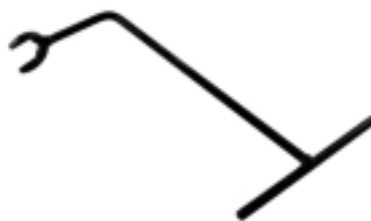

26 700 0183 

CHIAVE SERBATOIO - TANK TOOL
Vespa 50

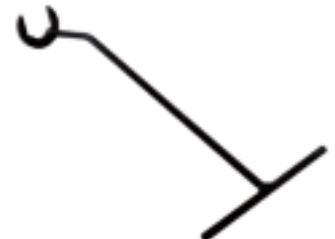



KIT RIPARAZIONE PNEUMATICI

TIRES REPAIR KIT

26 702 0110



Kit gonfiaggio e riparazione tubeless in borsa Rms composto da:

- 1 Tubetto mastice 12 cc.
- 1 Punteruolo
- 1 Tronchesino
- 3 bombolette Co2 16 Gr.
- 1 Raccordo universale
- 1 Prolunga raccordo flessibile
- 1 Set coni riparazione

Tyre repair kit In Rms bag

- 1 Rubber cement 12 cc.
- 1 Awl
- 1 Cutter
- 3 Carbon dioxide cartridgess
- 1 Universal connector
- 1 Flexible connector extension
- 1 Tire plug kit



26 702 0020



KIT RIPARAZIONE COPERTURA TUBELESS IN SCATOLA COMPOSTO DA:

1 tubetto mastice 22 cc - 2 punteruoli
1 taglierino - 5 pezzi di pura gomma

TUBLESS TYRE REPAIR KIT WITH:

1 Tyre rubber cement 22 cc tube - 2 Awles
1 Cutter - 5 rubber sticks

26 702 0120



BOMBOLETTA CO2 DI RICAMBIO

- Per il kit (26 702 0110)
- 16 gr. Con filetto
- Confezione da 3 Pz.

CARBON DIOXIDE CARTRIDGES

- For kit (26 702 0110)
- 16 gr. with thread
- Pack of 3 pcs

26 702 0150



- 25 gr. Con filetto
- Confezione da 20 Pz.
- 25 gr. with thread
- Pack of 20 pcs



26 702 0030



Stecche di gomma
per riparazione tubeless
Tyre repairing rubber sticks



26 702 0100



Scatola tubetti mastice 22 cc
(cont. 12 tubetti)
Pack 12 pcs tyre rubber cement 22 cc tubes



26 702 0050



Kit riparazione camera d'aria (no Tubeless)
Confezione in blister composto da:

- 5 pezze assortite
 - 1 tubetto mastice 10 cc
 - 1 raschietto
- Inner tube repair kit
Blister packaging with:
5 tyre repair patches
1 Rubber cement 10 cc tube
1 Scraper

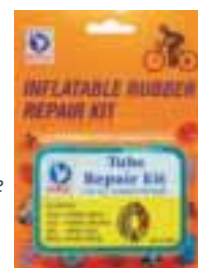



26 700 2060 

KIT PRONTO SOCCORSO - FIRST AID PACK

Conforme DIN13167 - 2014

Contenuto:

- 1 x rotolo cerotto adesivo
- 4 x bende adesive (10 x 6cm)
- 2 x cerotti resistenti all'acqua confezionati singolarmente (4 x 6,5 cm)
- 2 x cerotti resistenti all'acqua (12 x 2 cm)
- 2 x cerotti resistenti all'acqua confezionati singolarmente (1,9 x 7,2 cm)
- 4 x cerotti resistenti all'acqua confezionati singolarmente (2,5 x 7,2 cm)
- 1 x tampobenda sterile (8 x 10 cm)
- 1 x tampobenda sterile (10 x 12 cm)
- 1 x fasciatura sterile (ustioni)
- 1 x coperta isoterma d'emergenza
- 1 x forbici
- 4 x guanti monouso
- 2 x salviettine umidificate confezionate singolarmente
- 1 x lista del contenuto
- 1 x manuale kit pronto soccorso

Conforms to DIN13167 - 2014

Kit contents:

- 1 x adhesive plaster tape
- 4 x adhesive plaster bandages (10 x 6cm)
- 2 x water resistant single-packed plasters (4 x 6,5 cm)
- 2 x water resistant plasters (12 x 2 cm)
- 2 x water resistant single-packed plasters (1,9 x 7,2 cm)
- 4 x water resistant single-packed plasters (2,5 x 7,2 cm)
- 1 x first aid bandage roll (8 x 10 cm)
- 1 x first aid bandage roll (10 x 12 cm)
- 1 x sterile dressing (burns)
- 1 x first aid blanket
- 1 x scissors
- 4 x disposable gloves
- 2 x single-packed wet wipes
- 1 x list of contents
- 1 x first aid kit manual





ACCESSORI ACCESSORIES

26 700 2010



XSTRAP
STANDARD DUTY

SET 2 CINGHIE A CRICCHETTO PER TRASPORTO MOTO

- Lunghezza 3 Mt.
- Carico d'esercizio 136 Kg.
- Carico Max 408 Kg.

2 RATCHET TIE DOWN

- Length 3 Mt.
- Safe work load 136 Kg.
- Break strenght 408 Kg.



26 700 2020



XSTRAP
HEAVY DUTY

SET 2 CINGHIE A CRICCHETTO PER TRASPORTO MOTO

- Lunghezza 3 Mt.
- Carico d'esercizio 454 Kg.
- Carico Max 1363 Kg.

2 RATCHET TIE DOWN

- Length 3 Mt.
- Safe work load 454 Kg.
- Break strenght 1363 Kg.



26 700 2040



RETE ELASTICA FISSAGGIO BAGAGLI

- Dimensioni 40 x 40 Cm.
- 10 ganci metallici rivestiti in gomma

CARGO STRETCH NET

- Dimensions 40 x 40 Cm.
- 10 coated steel hooks



26 700 2050



RETE ELASTICA FISSAGGIO BAGAGLI

- Dimensioni 40 x 80 Cm.
- 10 ganci metallici rivestiti in gomma

CARGO STRETCH NET

- Dimensions 40 x 80 Cm.
- 10 coated steel hooks



26 700 2110



TAGLIA - SIZE: M 203x89x119 cm

26 700 2120



TAGLIA - SIZE: L 228x99x124 cm

26 700 2130



TAGLIA - SIZE: XL 246x104x127 cm

26 700 2140



TAGLIA - SIZE: XXL 264x104x127 cm

TELO COPRI MOTO

- Materiale: PEVA+PP
- Per esterni: impermeabile e resistente UV
- Cuciture termosaldate
- Anello antifurto
- Cinghia chiusura sottomoto

MOTORCYCLE COVER

- Material: PEVA+PP
- Outdoor use: water and UV resistant
- Termoweld stitch
- Lock hole
- Under motorbike strap



26 700 2140 su BMW R1200RT con valigie e bauletto
26 700 2140 on BMW R1200RT with side bag and top case



26 700 1000 

EASY RIDER

- Kit di riparazione pneumatici
- Compressore d'aria ad alta pressione adatto per gomme scooter, auto, bici, Atv
- Connettori: Pinze batteria, anelli batteria, presa 12V accendisigari
- Tempi di gonfiaggio: Pneumatico moto 3 min
Pneumatico auto standard 5 min.
- Adattatori giochi gonfiabili e pneumatici ciclo

- *Tire repair kit*
- *High pressure air compressor for scooter, car, bicycle and Atv*
- *Power connections: Scooter rings, crocodile clamps, 12V plug*
- *Inflation times: Scooter tire 3 min - Standard car tire 5 min*
- *Adaptors for inflatable toys and bicycle tire*

- Pressione massima 6 bars
Max pressure 6 Bars
- Dimensioni: 120 x 145 mm
Dimensions: 120 x 145 mm
- Manometro integrato
Built in pressure gauge
- Flacone 250 ml di prodotto sigillante
250 ml sealant bottle



26 700 1010 

EASY RIDER MODELLO BMW

- Kit di riparazione pneumatici
- Compressore d'aria ad alta pressione adatto per gomme scooter, auto e bici
- Connettori: Spina 12V modello DIN (3,4 m)
- Tempi di gonfiaggio: Pneumatico moto 3 min

- *Tire repair kit*
- *High pressure air compressor*
- *Power connections: 12V Plug DIN (3,4 m)*
- *Inflation times: Motorcycle tire 3 min*

- Pressione massima 6 bars
Max pressure 6 Bars
- Dimensioni: 120 x 145 mm
Dimensions: 120 x 145 mm
- Manometro integrato
Built in pressure gauge
- Flacone 250 ml di prodotto sigillante
250 ml sealant bottle



26 700 1030 

TOUR

- Kit di riparazione pneumatici
- Compressore d'aria ad alta pressione adatto per gomme scooter, auto e bici
- Connettori: Spina 12V modello DIN (3,4 m)
- Tempi di gonfiaggio: Pneumatico moto 3 min

- *Tire repair kit*
- *High pressure air compressor*
- *Power connections: 12V Plug DIN (3,4 m)*
- *Inflation times: Motorcycle tire 3 min*

- Pressione massima 6 bars
Max pressure 6 Bars
- Dimensioni: 120 x 145 mm
Dimensions: 120 x 145 mm
- Manometro integrato
Built in pressure gauge



26 720 0600 

FLACONE 250 ML DI PRODOTTO SIGILLANTE - 250 ML SEALANT BOTTLE

- Tecnologia gel
- Facilmente lavabile ad acqua

- *Gel technology*
- *Washed off with water*





LINEA PRODOTTI AIRMAN

AIRMAN PRODUCTS

26 700 1020



AIRGUN

- Compressore professionale ricaricabile senza fili
- Pressione massima 10 Bar
- Adattatori giochi gonfiabili e pneumatici ciclo
- Applicabile a: ATV, Pneumatici ciclo, equipaggiamenti sportivi

- High pressure professional air compressor
- rechargeable cordless
- Max pressure 10 Bar
- Adaptor for inflatable toys and bicycle tire
- Applications: ATV, Bicycle tires, sporting equipments

- Dimensioni: 160 x 260 mm
Dimensions: 160 x 260 mm
- Manometro integrato a led
Built in pressure led gauge
- Settaggio della pressione
Pressure preset
- 1 Batteria Li-ion 230V ricaricabile, 1 con adattatore 12V (3,4 m)
1 rechargeable Li-ion batterie 230V, 1 with 12V plug (3,4 m)



AIRMAN : CARATTERISTICHE TECNICHE - TECHNICAL FEATURES

	EASY RIDER	AIRGUN	EASY RIDER	AIRGUN
NOTA - NOTE	Può lavorare al max 10 minuti in continuo	Può lavorare al max 10 minuti in continuo	Can work max 10 minutes continuously	Can work max 10 minutes continuously
COMPRESSORE - COMPRESSOR				
Corrente - Power	10A	10A	10A	10A
Pressione massima - Max pressure	6 bars	10 bars	6 bars	10 bars
Dimensioni (BxH) - Compressor size (BxH)	120 x 145 mm	160 x 260 mm batteria inclusa	120 x 145 mm	160 x 260 mm included Battery
Connettori - Power connection	Modello standard: Pinze batteria, anelli batteria, presa 12V accendisigari Modello Bmw: Spina 12V Modello DIN	Batteria con 12V adattatore, 230V-Li-Ion-battery	Standard model: Scooter rings, Crocodile clamps, 12V plug Bmw model: 12V Plug DIN	Battery with 12V plug, 230V-Li-Ion-battery
Indicatore di Pressione - Pressure display	Indicatore in bar & psi	Pre-set, indicatore in bar, kpi, psi	Lighted display in bar & psi	Pre-set, lighted display in bar, kpi, psi
Tempi di gonfiaggio gomme (2,5 bar): <i>Inflation times (2,5 bar):</i>	Bici 3:00 Minuti Auto (media) 5:00 Minuti Auto (grande) 7:30 Minuti	Bici 1:00 Minuto Moto 3:00 Minuti	Bicycle 3:00 Minutes Car (standard) 5:00 Minutes Car (big) 7:30 Minutes	Bicycle 1:00 Minute Motorcycle 3:00 Minutes
SIGILLANTE - SEALANT				
Tipo - Sealant type	Tecnologia Gel	-	Particle Gel Technology	-
Quantità - Sealant size	250 ml	-	250 ml	-
Dimensione foro massimo - Max. puncture	10 mm	-	10 mm	-
Proprietà del sigillante <i>Properties of sealant</i>	Lavabile ad acqua con estrema facilità, non tossico, non infiammabile	-	Washed off with water, non-toxic, Non-flammable	-
Durata a stock - Shelf life	5 anni	-	5 years	-
ACCESSORI - ACCESSORIES				
Adattatori / Giochi - Adaptor / toys	Gomme bici (bassa pressione), palloni, gonfiabili	Bike tires (also high pressure), Balls, inflatable toys, extension hose, line adaptor	Bike tires (low pressure), balls, inflatable toys, valve extractor	Bike tires (also high pressure), Balls, inflatable toys, extension hose, line adaptor
Confezione - Transport bag	Borsa con logo	Borsa con logo	Cotton bag with Logo	Nylon bag with Logo
SICUREZZA - SAFETY				
Distanza percorribile dopo la riparazione <i>Recommended driving distance after repair</i>	max. 200 km	-	max. 200 km	-
Velocità max dopo la riparazione <i>Max. speed limit</i>	80 km/h	-	80 km/h	-
Certificazioni - Certification	CE-Certification, ISO 9001:2008, ISO 14001:2004, ISO TS 16949:2	CE-Certification, ISO 9001:2008, ISO 14001:2004, ISO TS 16949:2	CE-Certification, ISO 9001:2008, ISO 14001:2004, ISO TS 16949:2	CE-Certification, ISO 9001:2008, ISO 14001:2004, ISO TS 16949:2

▶ GOMME
TIRES

▶ CAMERE D'ARIA
TUBES

▶ **KENDA**

▶ 
DURO

IL LINGUAGGIO DELLE SCOLPITURE	
COMAND 2	Stradale
MAC P	Stradale posteriore
MICH	Scolpitura tradizionale stradale
MICH M+S	 Scolpitura tradizionale stradale invernale
BOPP	Sportivo stradale
ROAD	Stradale
REGGAE	Tassellato largo doppio uso
MAC F	Stradale anteriore
SLICK	Scolpitura liscia stradale
DEXT	Tassello misto stradale
DEXT M+S	Tassello misto stradale - <i>All seasons</i>
DRAGO F	Scolpitura liscia stradale anteriore
DRAGO	Scolpitura liscia stradale posteriore
COMAND P	Stradale posteriore
DRAKE	Scolpitura liscia stradale posteriore
ROCK	Sterrato
UNIK	Tassellato medio stradale
CHOCOLATE	Tassello alto fuoristrada
CLASSIC	Tassello quadro stradale

COME "SCEGLIERE" UN PNEUMATICO - HOW TO "CHOOSE" A TYRE	
1	Marchio di fabbrica - <i>Trade-Mark</i>
2	Senso di rotolamento - <i>Sense of Rotation</i>
3	Pneumatico senza camera aria - <i>Tyre without tube "Tubeless"</i>
4	Simbolo categoria velocità - <i>Category Speed Symbol</i>
5	Indice di carico - <i>Charge Index</i>
6	Tipo di battistrada - <i>Tyre Tread Type</i>
7	Diametro nominale di calettamento (in pollici) - <i>Nominal Keying Diameter (in inches)</i>
8	Rapporto altezza/sezione H/S - <i>Ratio Height/Section H/S</i>
9	Larghezza nominale di sezione (mm) - <i>Nominal Section Length (mm)</i>

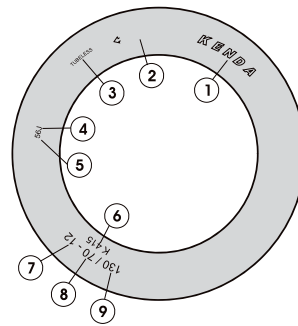

LE "MISURE" DEL PNEUMATICO - THE "MEASURES" OF THE TYRE	
D	Diametro esterno - <i>External Diameter</i>
H	Altezza di sezione - <i>Section Height</i>
S	Sezione massima del pneumatico - <i>Maximum Tyre Section</i>
Ø	Diametro di calettamento - <i>Keying Diameter</i>



INDICE DI CARICO - LOAD INDEX

LI	KG.	LBS	LI	KG.	LBS	LI	KG.	LBS
19	77,5	112,7	47	175	254,4	75	387	562,5
20	80	116,3	48	180	261,6	76	400	581,4
21	82,5	119,9	49	185	268,9	77	412	598,9
22	85	123,6	50	190	276,2	78	425	617,8
23	87,5	127,2	51	195	283,5	79	437	635,2
24	90	130,8	52	200	290,7	80	450	654,1
25	92,5	134,5	53	206	299,4	81	462	671,6
26	95	138,1	54	212	308,2	82	475	690,5
27	97,5	141,7	55	218	316,9	83	487	707,9
28	100	145,4	56	224	325,6	84	500	726,8
29	103	149,7	57	230	334,3	85	515	748,6
30	106	154,1	58	236	343	86	530	770,4
31	109	158,4	59	243	353,2	87	545	792,2
32	112	162,8	60	250	363,4	88	560	814
33	115	167,2	61	257	373,6	89	580	843,1
34	118	171,5	62	265	385,2	90	600	872,2
35	121	175,9	63	272	395,4	91	615	894
36	125	181,7	64	280	407	92	630	915,8
37	128	186,1	65	290	421,5	93	650	944,8
38	132	191,9	66	300	436,1	94	670	973,9
39	136	197,7	67	307	446,3	95	690	1003
40	140	203,5	68	315	457,9	96	710	1032,1
41	145	210,8	69	325	472,4	97	730	1061,1
42	150	218	70	335	487	98	750	1090,2
43	155	225,3	71	345	501,5	99	775	1126,5
44	160	232,6	72	355	516	100	800	1162,9
45	165	239,8	73	365	530,6			
46	170	247,1	74	375	545,1			

CODICE DI VELOCITA' - SPEED SYMBOL

CODICE - SYMBOL	VELOCITA' - SPEED (KM/H)
B	50
C	60
D	65
E	70
F	80
G	90
J	100
K	110
L	120
M	130
N	140
P	150
Q	160
R	170
S	180
T	190
H	210
V	240
W	270

10"

CODICE CODE	MISURA SIZE	BATTISTRADA TREAD	PATTERN	INDICE DI CARICO LOAD INDEX	INDICE DI VELOCITÀ SPEED INDEX	COPERTURE TYRES	BARCODE
99 110 0001	3.00-10	Mich 83	K333	42	J	TT	
99 110 0005	3.00-10	-	K333	42	J	TT	
99 110 0102	3.00-10	Mich M+S	K701	47	L	TL	
99 120 0102	3.50-10	Mich M+S	K701	56	L	TL	
99 120 0001	3.50-10	Mich 83	K333	51	J	TT	
99 120 0003	3.50-10	-	K333	51	J	TT	
99 160 5002	90/90-10	Bopp	K413	50	J	TL	
99 160 7002	90/90-10	Dext	K415	50	J	TL	
99 170 5002	100/80-10	Bopp	K413	52	J	TL	
99 170 5003	100/80-10	Bopp	K413	53	M	TL	
99 170 9003	100/80-10	Unik	K423	53	M	TL	
99 180 7002	100/90-10	Dext	K415	56	J	TL	
99 188 9003	120/70-10	Unik	K423	54	M	TL	
99 190 1003	120/90-10	Road	K346	57	J	TL	
99 190 5002	120/90-10	Bopp	K413	56	J	TL	
99 190 5003	120/90-10	Bopp	K413	57	M	TL	
99 190 5004	120/90-10	Bopp	K413	57	J	TL	
99 190 6003	120/90-10	Chocolate	K451	57	J	TL	
99 190 8002	120/90-10	Reggae	K761	56	J	TL	
99 207 5002	130/70-10	Bopp	K413	52	J	TL	
99 200 1002	130/90-10	Road	K346	61	J	TL	
99 200 5002	130/90-10	Bopp	K413	61	J	TL	
99 200 5003	130/90-10	Bopp	K413	61	M	TL	
99 200 6002	130/90-10	Chocolate	K451	61	J	TL	
99 200 7002	130/90-10	Dext	K415	61	J	TL	
99 200 8002	130/90-10	Reggae	K761	61	J	TL	
99 500 8002	150/80-10	Reggae	K761	65	L	TL	

TL = Tubeless - TT = Set copertura + camera (Kit tyre and inner tube)



11"							
CODICE CODE	MISURA SIZE	BATTISTRADA TREAD	PATTERN	INDICE DI CARICO LOAD INDEX	INDICE DI VELOCITÀ SPEED INDEX	COPERTURE TYRES	BARCODE
99 554 9002	110/70-11	Unik	K423	45	L	TL	
99 554 9003	110/70-11	-	K415 M+S	45	M	TL	
99 554 9004	110/70-11	Mich M+S	K701	45	M	TL	
99 564 5003	120/70-11	Unik	K423	56	L	TL	
99 564 5004	120/70-11	-	K415 M+S	56	L	TL	
99 564 5005	120/70-11	Mich M+S	K701	56	L	TL	

TL = Tubeless

12"							
CODICE CODE	MISURA SIZE	BATTISTRADA TREAD	PATTERN	INDICE DI CARICO LOAD INDEX	INDICE DI VELOCITÀ SPEED INDEX	COPERTURE TYRES	BARCODE
99 143 1002	100/60-12	Mach 2	K433F	39	J	TL	
99 183 5003	110/70-12	Bopp	K413	56	M	TL	
99 186 5002	110/90-12	Bopp	K413	64	J	TL	
99 186 5003	110/90-12	Bopp	K413	64	M	TL	
99 196 1104	120/70-12	Drago F	K763F	51	P	TL	
99 196 1105	120/70-12	Mich M+S	K701	58	P	TL	
99 196 5002	120/70-12	Bopp	K413	51	J	TL	
99 196 5003	120/70-12	Bopp	K413	51	M	TL	
99 196 7002	120/70-12	Dext	K415	51	J	TL	
99 196 8002	120/70-12	Reggae	K761	51	J	TL	
99 198 8002	120/80-12	Reggae	K761	65	J	TL	
99 206 1104	130/70-12	Drago	K763	62	P	TL	
99 206 1105	130/70-12	Mich M+S	K701	62	P	TL	
99 206 5002	130/70-12	Bopp	K413	56	J	TL	
99 206 5003	130/70-12	Bopp	K413	62	M	TL	
99 206 7002	130/70-12	Dext	K415	56	J	TL	
99 206 8002	130/70-12	Reggae	K761	56	J	TL	
99 202 8002	130/80-12	Reggae	K761	69	J	TL	
99 211 5002	140/70-12	Bopp	K413	60	J	TL	
99 211 5003	140/70-12	Bopp	K413	60	M	TL	

TL = Tubeless

13"

CODICE CODE	MISURA SIZE	BATTISTRADA TREAD	PATTERN	INDICE DI CARICO LOAD INDEX	INDICE DI VELOCITÀ SPEED INDEX	COPERTURE TYRES	BARCODE
99 187 1104	110/90-13	Drago F	K763F	56	P	TL	
99 197 5003	120/70-13	Bopp	K413	53	M	TL	
99 197 5004	130/70-13	-	K703 F	53	P	TL	
99 205 5002	130/60-13	Bopp	K413	53	J	TL	
99 205 5003	130/60-13	Bopp	K413	53	M	TL	
99 205 8002	130/60-13	Reggae	K761	53	J	TL	
99 208 1103	130/70-13	Drago	K763	57	M	TL	
99 208 1104	130/70-13	Drago	K763	63	P	TL	
99 208 1105	130/70-13	-	K703	57	P	TL	
99 212 5002	140/60-13	Bopp	K413	57	J	TL	
99 212 5003	140/60-13	Bopp	K413	57	M	TL	
99 212 8002	140/60-13	Reggae	K761	57	J	TL	
99 215 1305	150/70-13	Mach P	K434	64	S	TL	

TL = Tubeless



14"

CODICE CODE	MISURA SIZE	BATTISTRADA TREAD	PATTERN	INDICE DI CARICO LOAD INDEX	INDICE DI VELOCITÀ SPEED INDEX	COPERTURE TYRES	BARCODE
99 346 1300	100/90-14	Mach P	K434	51	P	TL	
99 185 0002	110/80-14	Classic	K425	59	J	TL	
99 464 1205	120/70-14	Drake F	K764F	55	S	TL	
99 464 1305	120/70-14	Mach 2	K433F	55	S	TL	
99 465 1100	120/80-14	Drago	K763	58	P	TL	
99 483 1205	140/60-14	Drake	K764	64	S	TL	
99 484 1205	140/70-14	Drake	K764	68	S	TL	
99 484 1305	120/80-14	Mach 2	K433F	58	S	TL	
99 504 1305	150/70-14	Mach P	K434	66	S	TL	

TL = Tubeless



15"

CODICE CODE	MISURA SIZE	BATTISTRADA TREAD	PATTERN	INDICE DI CARICO LOAD INDEX	INDICE DI VELOCITÀ SPEED INDEX	COPERTURE TYRES	BARCODE
99 198 1002	120/70-15	Mach 2	K433F	56	S	TL	
99 199 1002	130/80-15	Road	K346	63	P	TL	

16"

CODICE CODE	MISURA SIZE	BATTISTRADA TREAD	PATTERN	INDICE DI CARICO LOAD INDEX	INDICE DI VELOCITÀ SPEED INDEX	COPERTURE TYRES	BARCODE
99 145 0002	70/90-16	Classic	K425	42	J	TL	
99 310 0001	2½ 16	Mich	K77	31	B	TT	
99 310 1001	2.50-16	Slick	K327	36	J	TT	
99 310 1002	2.50-16	Slick	K327	42	J	TT	
99 320 1001	2¾16	Slick	K327	36	B	TT	
99 330 1001	2¾16	Slick	K327	40	J	TT	
99 330 1002	2¾16	Slick	K327	46	J	TL	
99 150 0002	80/80-16	Classic	K425	46	J	TL	
99 150 0004	80/80-16	Classic	K425	46	P	TL	
99 336 1300	90/90-16	Mach P	K434	48	P	TL	
99 155 0002	90/80-16	Classic	K425	52	J	TL	
99 157 0004	100/80-16	Classic	K425	56	P	TL	
99 157 1104	100/80-16	Drago F	K763F	56	P	TL	
99 345 1104	100/80-16	Drago	K763	50	P	TL	
99 345 1105	100/80-16	Mich M+S	K701	50	P	TL	
99 354 2004	110/70-16	Mac F	K671F	52	P	TL	
99 365 1104	120/80-16	Drago	K763	60	P	TL	
99 365 1105	120/80-16	Mich M+S	K701	60	P	TL	
99 365 2004	120/80-16	Comand P	K430	60	P	TL	
99 158 2005	130/70-16	Mac P	K671	61	S	TL	
99 159 1104	130/80-16	Drago	K763	64	P	TL	
99 384 2004	140/70-16	Mac P	K671	65	P	TL	

TT = Set copertura + camera (Kit tyre and inner tube)



17"							
CODICE CODE	MISURA SIZE	BATTISTRADA TREAD	PATTERN	INDICE DI CARICO LOAD INDEX	INDICE DI VELOCITÀ SPEED INDEX	COPERTURE TYRES	BARCODE
99 340 0001	2.00	Mich	K77		Non omologata Not homologated	TT	
99 340 0101	2.50	Off Road	K772A		Non omologata Not homologated	TL	

TT = Set copertura + camera (Kit tyre and inner tube)



TRASPORTO							
CODICE CODE	MISURA SIZE	BATTISTRADA TREAD	PATTERN	INDICE DI CARICO LOAD INDEX	INDICE DI VELOCITÀ SPEED INDEX	COPERTURE TYRES	BARCODE
99 130 0001	4.50-10	Trasporto	K355	72	M	TT	
99 130 0002	4.50-10	Trasporto	K355	76	M	TT	

TT = Set copertura + camera (Kit tyre and inner tube)



TR13	TR4	TR6	TR87
Valvola standard rivestita in gomma <i>Rubber covered straight valve</i> L: 35 mm Ø foro valvola: 11,5 mm Ø Valve hole: 11,5 mm	Valvola standard con base in gomma <i>Straight valve with rubber base</i> L: 33 mm Ø foro valvola: 7,5 mm Ø Valve hole: 7,5 mm	Valvola standard con base in gomma <i>Straight valve with rubber base</i> L: 33 mm Ø foro valvola: 8,3 mm Ø Valve hole: 8,3 mm	Valvola a gomito con base in gomma <i>90° valve with rubber base</i> A: 17 mm - B: 33 mm 90° Ø foro valvola: 10,2 mm Ø Valve hole: 10,2 mm

CODICE CODE	MISURA SIZE	MARCA TRADE MARK	VALVOLA VALVE	CONFEZIONE PACKAGING	BARCODE
99 910 0000	3.50-8	KENDA	TR 13 (1)	Scatola	
99 910 0100	3.50-8	KENDA	TR 87 (1)	Scatola	
99 920 0001	3.00/3.50-10	KENDA	TR 87 (1)	Scatola	
99 925 0001	100/110/90-10	KENDA	TR 87 (1)	Scatola	
99 930 0001	120/130/90-10	KENDA	TR 87 (1)	Scatola	
99 932 0001	120/130/70-12	KENDA	TR 87 (1)	Scatola	
99 933 0001	130/60-13	KENDA	TR 87 (1)	Scatola	
99 940 0001	4.50-10	KENDA	TR 13 (1)	Scatola	
99 942 0001	4.50-12	KENDA	TR 13 (1)	Scatola	
99 950 0001	2.75/3.00-14	KENDA	TR 6 (1+4)	Scatola	
99 960 0001	2.25/2.50-16	KENDA	TR 6 (1+4)	Scatola	
99 970 0001	2.75-16	KENDA	TR 6 (1+4)	Scatola	
99 990 0001	2.00/2.25-17	KENDA	TR 6 c	Scatola	
99 990 0101	2.25/2.50-17	KENDA	TR 4 (1+4)	Scatola	
99 991 0201	2.75/3.00-18	KENDA	TR 4 (1+4)	Scatola	
99 990 0201	2.50/2.75-17	KENDA	TR 4 (1+4)	Scatola	

(1) Valvola vulcanizzata - (4) Valvola munita di rondella bloccaggio

VALVOLE TUBELESS - TUBELESS VALVE			
99 999 9000 		99 999 9010 	
TR413 Valvola standard rivestita in gomma <i>Rubber covered straight valve</i> L: 35 mm Ø foro valvola: 11,5 mm Ø Valve hole: 11,5 mm		PVRT70 Valvola a gomito con base in gomma <i>90° valve with rubber base</i> A: 17 mm B: 33 mm 90° Ø foro valvola: 10,2 mm Ø Valve hole: 10,2 mm	

COPERTURE 10" - 14" - CARRIOLA

TIRES 10" - 14" - WHEEL BARROW

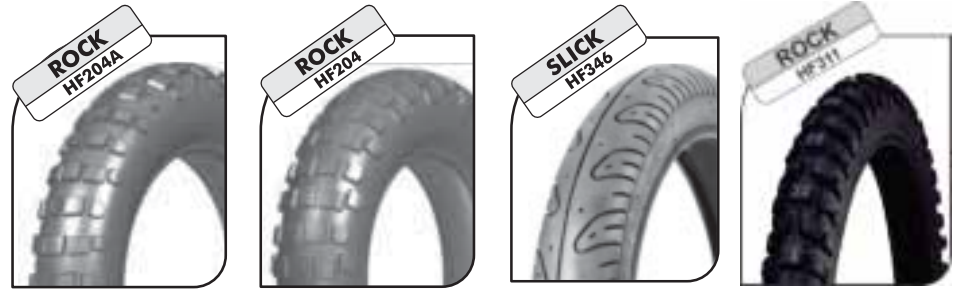

10"									
CODICE CODE	MISURA SIZE	BATTISTRADA	PATTERN	N° TELE	INDICE DI CARICO LOAD INDEX	INDICE DI VELOCITÀ SPEED INDEX	COPERTURE TYRES	VALVOLE VALVES	BARCODE
99 110 3001	3.00-10	Rock	HF204A	4	Non omologata <i>Not homologated</i>		TT	TR87	
99 120 3001	3.50-10	Rock	HF204	4	Non omologata <i>Not homologated</i>		TT	TR87	
14"									
99 210 2001	80/80-14	Slick	HF346	-	43	J	TT	-	
16"									
99 310 1003	2.50-16	Rock	HF311	4	36	L	-	-	

TT = Set copertura + camera (Kit tyre and inner tube) - TL = Tubeless

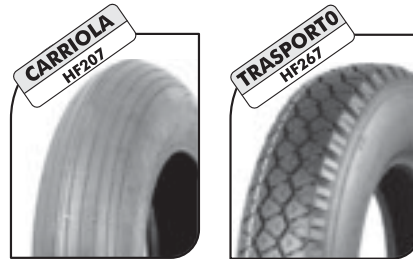

CARRIOLA									
CODICE CODE	MISURA SIZE	BATTISTRADA	PATTERN	N° TELE	INDICE DI CARICO LOAD INDEX	INDICE DI VELOCITÀ SPEED INDEX	COPERTURE TYRES	VALVOLE VALVES	BARCODE
99 100 2101	3.50-8	Carriola	HF207	-	-	-	TT	TR13	
TRASPORTO									
99 130 0020	4.50-10	Trasporto	HF267	6	76	M	-	-	
99 129 0020	4.00-12	trasporto	HF267	-	Non omologata <i>Not homologated</i>		-	-	

TT = Set copertura + camera (Kit tyre and inner tube)



CONDIZIONI GENERALI DI VENDITA

Gli ordini sono assunti "salvo approvazione della casa" e tale approvazione viene anche manifestata con la sola evasione degli stessi. Con il conferimento degli ordini si intendono accettate dal committente, senza riserve, le condizioni generali di seguito riportate.

- 1) I prodotti inclusi nei cataloghi sono di normale vendita. Agli stessi potranno essere apportate modifiche e varianti al fine di migliorare la funzionalità. Le illustrazioni e le caratteristiche tecniche rappresentate nei cataloghi pertanto non sono vincolanti. Tutti i Riferimenti Originali sono di proprietà esclusiva delle case produttrici.
- 2) I prezzi esposti nei listini non sono impegnativi, in quanto potranno essere aggiornati in qualunque momento, per intervenute variazioni dei relativi costi.
- 3) Gli ordini verranno evasi secondo la disponibilità del momento senza garanzie di saldo. Eventuali rimanenze saranno inviate appena disponibili, salvo che vengano annullate dal committente al ricevimento della prima spedizione.
- 4) La merce viaggia a rischio e pericolo del committente anche se venduta Franco Fabbrica.
- 5) Il pagamento della fornitura deve essere effettuato esclusivamente presso la sede del venditore, con le modalità ed entro i termini stabiliti al perfezionamento del contratto di vendita. L'eventuale emissione di tratte o di ricevute bancarie non comporta deroga del luogo di pagamento. In caso di ritardato pagamento di una o più forniture decorreranno a carico del compratore gli interessi secondo il tasso praticato dalle banche sugli scoperti di conto corrente. Il mancato o ritardato pagamento di una fornitura ci autorizza a ritenerci liberi da qualsiasi impegno e a ritenere annullati tutti i contratti di vendita in corso. Non sono accettati pagamenti con rimesse dirette. Per i nuovi clienti il pagamento dei primi ordini dovrà avvenire esclusivamente con bonifico bancario anticipato o in contrassegno.
- 6) Resi per errata ordinazione od errata spedizione saranno accettati solo se giustificati ed effettuati entro 15 (quindici) giorni dalla consegna della merce, comunque, preventivamente autorizzati da **RMS s.p.a.** inviando una mail a **logistica@rms.it**. Resi non precedentemente autorizzati dalla nostra Società o non accompagnati da documento di trasporto che deve recare gli estremi del nostro DDT o della ns. fattura di vendita non saranno accettati e di conseguenza saranno rinviati al mittente. I resi che NON rientrano nei termini qui sopra indicati (cioè oltre i 15 giorni dal ricevimento della merce) dovranno comunque essere autorizzati da **RMS s.p.a.** contattando **logistica@rms.it**.
- 7) Tutti i prodotti sono garantiti da regolare costruzione e funzionalità. L'eventuale restituzione di prodotti ritenuti difettosi dovrà essere preventivamente concordata con il venditore ed inviata in Porto Franco alla **RMS s.p.a.** I difetti lamentati dovranno essere specificati nella "bolla di accompagnamento" a fianco dei singoli prodotti resi e saranno presi in esame esclusivamente se la bolla recherà anche i riferimenti delle forniture (numero e data delle fatture del venditore). Qualora venga accettata la validità del reclamo la garanzia del venditore non andrà oltre l'accredito o la sostituzione dei prodotti stessi. I prodotti che invece risultassero non funzionanti per cause non imputabili alla loro qualità, bensì a seguito di manomissioni, rotture, errato montaggio, eccetera, saranno rispediti in porto assegnato al committente.
- 8) Al momento dell'ordinazione deve essere sempre precisato il codice articolo completo. Questo permetterà una evasione del Vs. ordine in modo corretto. Se al posto del nostro codice articolo vi fosse una semplice descrizione, la **RMS s.p.a.** non si assume alcuna responsabilità per eventuali errori.
- 9) Per qualsiasi controversia relativa alla interpretazione o esecuzione delle suddette condizioni, viene accettata dalle parti la competenza esclusiva del foro di Milano.

RMS s.p.a.

A norma delle leggi sul diritto d'autore e del codice civile. E' tassativamente vietata la riproduzione di questo catalogo/listino o di parte di esso, con qualsiasi metodo elettronico, meccanico, per mezzo di fotocopie, microfilms, registrazioni o altro. I diritti sono riservati per tutti i paesi.

Disegni e dati (descrizioni, caratteristiche, codifiche, prezzi ecc.) riportati su cataloghi e listini, possono essere soggetti a modifiche e variazioni. La **RMS s.p.a.** si riserva la facoltà di effettuare cambiamenti anche senza preavviso.

Tutti i riferimenti originali sono di proprietà esclusiva delle case produttrici.



GENERAL SALES CONDITIONS

The orders we receive are accepted "unless the company does not accept them" and the acceptance is declared just with the preparation of the material. By sending the order, the customer automatically accepts the following general conditions:

- 1) The products included in the catalogue are products sold normally by our company. To these products there can be the possibility of the application of changes and modifications in order to improve their usage. The photos, drawings and technical characteristics described in this catalogue are not at all binding.
- 2) The prices in the price list are to be considered not binding. They can be updated in every moment due to changes in the purchase prices.
- 3) The orders will be prepared according to the availability of the precise moment without any ensuring of the balance. The backorders will be sent to the customer with the following order unless they are deleted by the customer itself.
- 4) The material is shipped at risk of the customer as we are selling it ExWorks.
- 5) The payment should be done to the seller with conditions and terms previously decided. In case of any delayed payment there will be the extra charge of bank interests on the open amounts of debts on the bank account. The missed or delayed payment of just one invoice authorizes RMS s.p.a. to cancel all the selling contracts and commitments. For new customers we will accept only payment as advanced payment on proforma.
- 6) Warranty items will be accepted only when described and declared within 15 days from the delivery of the material, and they have anyway to be accepted and confirmed by **RMS s.p.a.** by sending a mail to **logistica@rms.it** or by filling in the form on our website. Warranty items sent to us without delivery note and descriptions of the problems, and without references to the invoice number and date, will be rejected and sent back to the customer. The warranty items which are not included into the already mentioned terms should anyway be authorized by **RMS s.p.a.** by contacting **logistica@rms.it**
- 7) All the products are guaranteed with correct quality and construction. The warranty items which has been authorized by **RMS s.p.a.** has to be sent free of charge to our storage. The defects and problems of the items should be mentioned on the delivery note traveling with the material sent back and they will be checked only if in the delivery note is mentioned also the date of invoice and number of the invoice. In case the warranty items will be accepted we will credit the value or substitute the items. All the products for which the damage is due to incorrect installation, breaking of parts after selling and tampering will be sent back to the customer at its costs.
- 8) While ordering there should be mentioned always the correct item code. This will allow us to prepare the order in a proper way. If there will just be a description of the item, **RMS s.p.a.** will not be responsible for any mistake.
- 9) For any dispute regarding interpretation and execution of the above mentioned conditions, the parties accept the exclusive competence of the court of Milan.

RMS s.p.a.

As for the copyright laws and the civil code laws, it's forbidden the reproduction of this catalogue/price list or any extract of the same with any electronical, mechanical means. No photocopies are allowed and also any microchips, recording or else. The rights are reserved for all the countries in which we sell.

Drawing, data (descriptions, characteristics, codes, price and so on) that are described on price lists and catalogues can be subject to changes and modifications. **RMS s.p.a.** has the right to change any of these conditions without any advanced notice.

All the original references are of exclusive property of the producers.

RMS SPA
Via Macallè 156 20831 Seregno (MB)
Tel. +39 0362 27301 Fax +39 0362 2730270
www.rms.it info@rms.it

